



Model created in COMSOL Multiphysics 6.4

# Tapered Waveguide

## Introduction

---

A tapered optical waveguide structure is used for matching two waveguides having different geometric cross sections and/or different material parameters. To minimize the loss due to coupling to radiation modes, the variation in geometrical or material parameters along the propagation direction needs to be very slow. This is the adiabatic limit, where a low-order mode in the input waveguide is gradually transformed to match the low-order mode of the receiving waveguide.

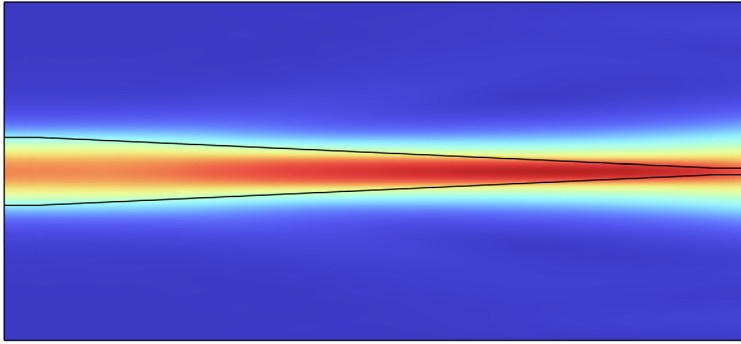

*Figure 1: A tapered waveguide structure. The wave enters from the left side, where the core is wide, and exits through the right side, where the waveguide core is narrow. With this relatively short taper length, some of the input radiation will be transformed into radiation losses during the propagation along the waveguide structure.*

However, in reality, to minimize the overall waveguide structure size, the taper length must be as short as possible. Thus, it is important to model the loss introduced by the taper.

In this tutorial model, a waveguide port generates the incident guided wave. When the wave propagates along the taper, some of the radiation is coupled to cladding modes. At the end of the waveguide structure, a Perfectly Matched Layer (PML), behind the output port, absorbs all the radiation reaching the port. The port itself does not absorb any radiation, but makes sure that proper S-parameter and transmittance variables are defined.

The simulation will be performed using the Electromagnetic Waves, Beam Envelopes interface. To use this interface, an approximation of the wave vector or phase must be provided. In this example, to make it possible to use a very coarse mesh, a user-defined phase will be used. Additionally, this tutorial describes how to define the wave vector, when employing a user-defined phase in combination with PML domains.

## *Model Definition*

---

The model demonstrates how to build the geometry from waveguide parts in the Wave Optics Module Part Library. In this model, two types of parts are used — straight and tapered slab waveguides. These parts define a number of predefined domain and boundary selections that are very useful when defining selections for materials, physics features, mesh, and in postprocessing. It is possible to use selections from specific domains or boundaries for each part instance, but cumulative selections can also be defined, including selections from many of the part instances.

To be able to use a very coarse mesh, a user-defined phase definition is provided for the Electromagnetic Waves, Beam Envelopes interface. For the input waveguide, the phase is given by

$$\text{phi} = \text{ewbe.beta}_1 * x$$

where  $\text{phi}$  is the phase,  $\text{ewbe.beta}_1$  is the propagation constant for the input port, and  $x$  is the coordinate in the propagation direction.

Similarly, for the output waveguide, the phase is given by

$$\text{phi} = \text{ewbe.beta}_2 * x + \text{phi0}$$

where  $\text{ewbe.beta}_2$  is the propagation constant for the output port and  $\text{phi0}$  is a constant defined to make the phase everywhere continuous along the waveguide structure.

To approximate the phase in the tapered waveguide, the propagation constant is assumed to be equal to  $\text{ewbe.beta}_1$  at the input waveguide and  $\text{ewbe.beta}_2$  at the output waveguide and to vary linearly between those two values along the tapered waveguide. So, the propagation constant is written as

$$kx = \text{ewbe.beta}_1 + (\text{ewbe.beta}_2 - \text{ewbe.beta}_1) * x / d_{\text{taper}}$$

where  $d_{\text{taper}}$  is the length of the tapered waveguide.

Since the phase is given by the integral of the propagation constant, the phase will have a quadratic dependence on  $x$ :

$$\text{phi} = \text{ewbe.beta}_1 * x + (\text{ewbe.beta}_2 - \text{ewbe.beta}_1) * x^2 / (2 * d_{\text{taper}})$$

So, the propagation constant  $kx$  can be defined as

$$kx = d(\text{phi}, x)$$

which is the derivative of  $\text{phi}$  with respect to  $x$ . This corresponds to the default relation between the wave vector and the phase for the Electromagnetic Waves, Beam Envelopes interface

$$\mathbf{k} = \nabla\phi. \quad (1)$$

However, to get the proper attenuation in the PML domains, the phase must be defined by

$$\phi = \text{ewbe.beta}_N \cdot \text{pm11.x} + \phi_0$$

where  $N$  in  $\text{ewbe.beta}_N$  is either 1 or 2 and  $\text{pm11.x}$  is a complex scaling coordinate in the PML that depends on  $x$  in both its real and imaginary parts.

The propagation constants in the PML are  $\text{ewbe.beta}_1$  and  $\text{ewbe.beta}_2$  in the input- and output-side PML, respectively. Thus, it is no longer possible to use the default relation between the phase and the wave vector, given by [Equation 1](#). Instead, variables must be defined for both  $k_x$  and  $\phi$  for all parts of the waveguide structure, as shown in [Table 1](#).

TABLE 1: WAVE VECTOR AND PHASE VARIABLE DEFINITIONS FOR THE WAVEGUIDE PARTS.

| PART              | KX  | PHI   |
|-------------------|---|---|
| Input PML         | $\text{ewbe.beta}_1$  | $k_x \cdot \text{pm11.x}$   |
| Input waveguide   | $\text{ewbe.beta}_1$  | $k_x \cdot x$   |
| Tapered waveguide | $\text{ewbe.beta}_1 + (\text{ewbe.beta}_2 - \text{ewbe.beta}_1) \cdot x / d_{\text{taper}}$ | $(k_x + \text{ewbe.beta}_1) \cdot x / 2$  |
| Output waveguide  | $\text{ewbe.beta}_2$  | $k_x \cdot (x - d_{\text{taper}}) + (\text{ewbe.beta}_1 + \text{ewbe.beta}_2) \cdot d_{\text{taper}} / 2$   |
| Output PML        | $\text{ewbe.beta}_2$  | $k_x \cdot (\text{pm11.x} - d_{\text{taper}} - \text{lam0}) + (\text{ewbe.beta}_1 + \text{ewbe.beta}_2) \cdot d_{\text{taper}} / 2 + k_x \cdot \text{lam0}$ |

## Results and Discussion

[Figure 2](#) shows the electric field distribution for the longest waveguide taper in the simulation (10,000 wavelengths long). For such a long waveguide, there is a very small

conversion of guided radiation to cladding mode radiation, as is shown in [Figure 3](#). This taper length regime is called the adiabatic limit, where the transmittance approaches one.

$n_{\text{taper}}(21)=10000$   $\lambda_0(1)=1.55 \mu\text{m}$  Electric field norm (V/m)

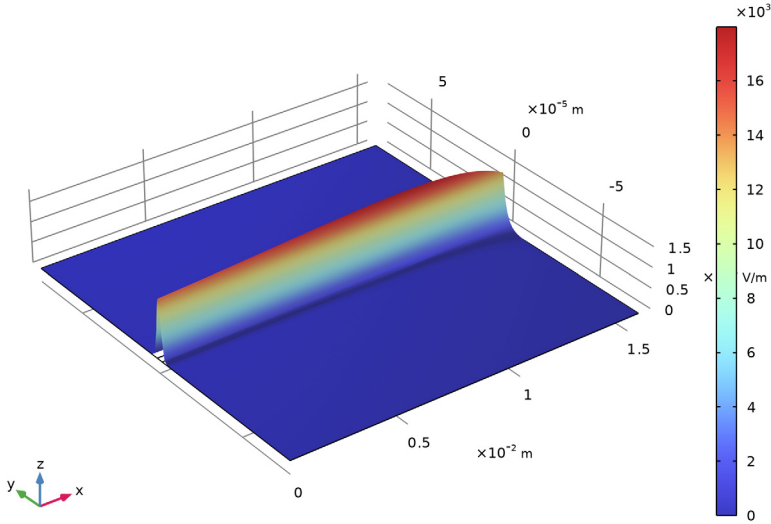

*Figure 2: The norm of the electric field for a 10,000 wavelengths long tapered waveguide structure.*

Figure 3 also shows that for very short tapers, the loss is almost independent of the taper length.

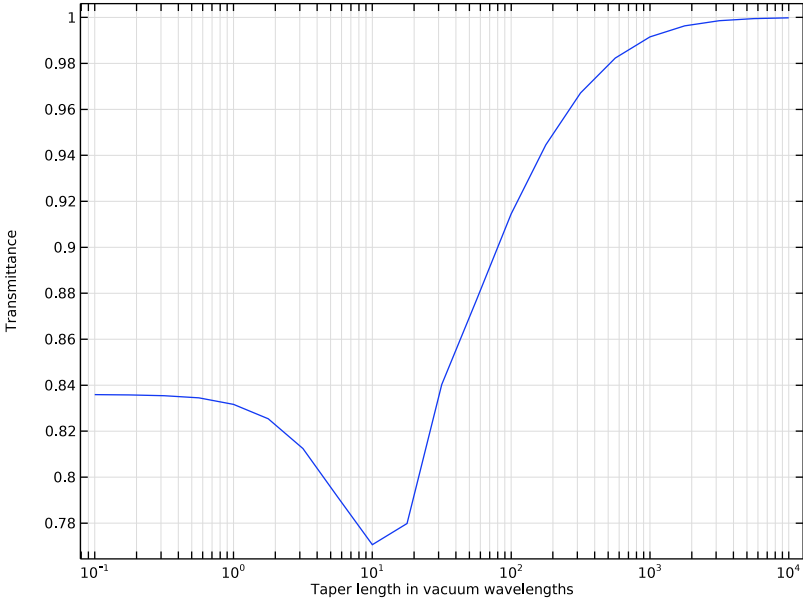

Figure 3: The transmittance for the guided mode through the waveguide structure.

Figure 4 shows the mode field for the input port. The mode is very much confined to the core region and the effective index is significantly larger than the cladding refractive index.

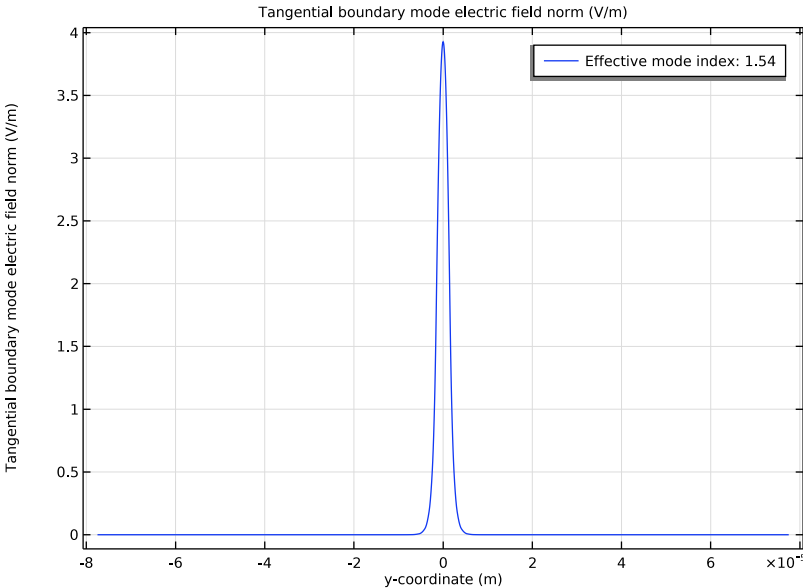

Figure 4: The mode field for the input port.

Figure 5 shows the mode field for the output port. As the output waveguide is very narrow, a large portion of the mode propagates in the cladding. Consequently, the effective index is very close to the refractive index in the cladding.

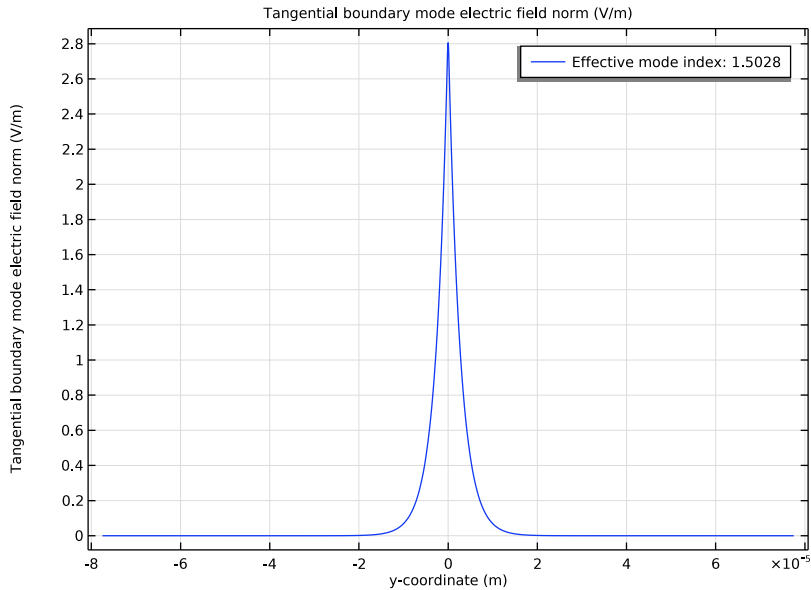

Figure 5: The mode field for the output port.

---

**Application Library path:** Wave\_Optics\_Module/Waveguides/tapered\_waveguide

---

### *Modeling Instructions*

---

From the **File** menu, choose **New**.

#### **NEW**

In the **New** window, click  **Model Wizard**.

#### **MODEL WIZARD**

- 1 In the **Model Wizard** window, click  **2D**.
- 2 In the **Select Physics** tree, select **Optics > Wave Optics > Electromagnetic Waves, Beam Envelopes (ewbe)**.

- 3 Click **Add**.
- 4 Click  **Study**.
- 5 In the **Select Study** tree, select **Preset Studies for Selected Physics Interfaces > Wavelength Domain**.
- 6 Click  **Done**.



## GLOBAL DEFINITIONS

### *Parameters I*

- 1 In the **Model Builder** window, under **Global Definitions** click **Parameters I**.
- 2 In the **Settings** window for **Parameters**, locate the **Parameters** section.
- 3 Click  **Load from File**.
- 4 Browse to the model's Application Libraries folder and double-click the file `tapered_waveguide_parameters.txt`.

These parameters define the geometry of the waveguide, the material properties for the different domains, and the wavelength and frequency used in the simulation.

## PART LIBRARIES

- 1 In the **Home** toolbar, click  **Windows** and choose **Part Libraries**.
- 2 In the **Part Libraries** window, select **Wave Optics Module > Slab Waveguides > slab\_waveguide\_taper** in the tree.
- 3 Click  **Add to Geometry**.

## GEOMETRY I

### *Tapered Waveguide*

- 1 In the **Model Builder** window, under **Component I (comp1) > Geometry I** click **Slab Waveguide Taper I (pi1)**.
- 2 In the **Settings** window for **Part Instance**, type Tapered Waveguide in the **Label** text field.

3 Locate the **Input Parameters** section. In the table, enter the following settings:

| Name                  | Expression | Value     | Description           |
|-----------------------|------------|-----------|-----------------------|
| input_core_width      | w_core_1   | 3.1E-6 m  | Input core width      |
| input_cladding_width  | w_clad_1   | 1.55E-4 m | Input cladding width  |
| output_core_width     | w_core_2   | 3.1E-7 m  | Output core width     |
| output_cladding_width | w_clad_2   | 1.55E-4 m | Output cladding width |
| element_length        | d_taper    | 3.1E-4 m  | Element length        |

Let the other table rows remain unchanged.

4 Locate the **Position and Orientation of Output** section. In the **Rotation angle** text field, type -90.

5 Click to expand the **Domain Selections** section. Click **New Cumulative Selection**.

6 In the **New Cumulative Selection** dialog, type **Core** in the **Name** text field.

7 Click **OK**.

8 In the **Settings** window for **Part Instance**, locate the **Domain Selections** section.

9 Click **New Cumulative Selection**.

10 In the **New Cumulative Selection** dialog, type **Non-PML** in the **Name** text field.

11 Click **OK**.

12 In the **Settings** window for **Part Instance**, locate the **Domain Selections** section.

13 In the table, enter the following settings:

| Name     | Keep | Physics | Contribute to |
|----------|------|---------|---------------|
| Core     |      | √       | Core          |
| Cladding |      | √       | None          |
| All      | √    | √       | Non-PML       |

Setting the value in the first row of the **Contribute to** column to **Core** will make the **Tapered Waveguide** domain selection contribute to a cumulative domain selection, representing all waveguide core domains.

Selecting the **Keep** checkbox in the last table row makes **All** domains in the **Tapered Waveguide** available as a separate domain selection. Furthermore, by setting the last value in the **Contribute to** column to **Non-PML**, the **Tapered Waveguide** domain selection

will contribute to a cumulative domain selection representing all domains that are not part of a Perfectly Matched Layer (PML).

The selections above will be used for defining selections for materials and variables as well as in postprocessing.

- 14** Click to expand the **Boundary Selections** section. In the table, enter the following settings:



| Name                 | Keep | Physics | Contribute to |
|----------------------|------|---------|---------------|
| Exterior             |      | √       | None          |
| Port 1 core          |      | √       | None          |
| Port 1 cladding      |      | √       | None          |
| Port 1               |      | √       | None          |
| Port 2 core          |      | √       | None          |
| Port 2 cladding      |      | √       | None          |
| Port 2               |      | √       | None          |
| Transverse perimeter | √    | √       | None          |

The **Transverse perimeter** represents the top and the bottom exterior boundaries for this part. This selection will later be used when defining the mesh.

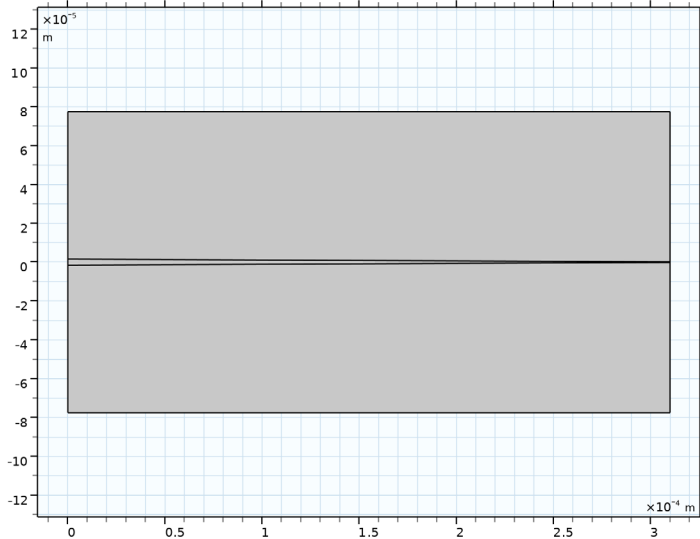
- 15** Click  **Build All Objects**.



## PART LIBRARIES

- 1 In the **Home** toolbar, click  **Windows** and choose **Part Libraries**.
- 2 In the **Model Builder** window, click **Geometry 1**.
- 3 In the **Part Libraries** window, select **Wave Optics Module > Slab Waveguides > slab\_waveguide\_straight** in the tree.
- 4 Click  **Add to Geometry**.

## GEOMETRY 1

### *Input Waveguide*

- 1 In the **Model Builder** window, under **Component 1 (comp1) > Geometry 1** click **Slab Waveguide Straight 1 (pi2)**.
- 2 In the **Settings** window for **Part Instance**, type **Input Waveguide** in the **Label** text field.
- 3 Locate the **Input Parameters** section. In the table, enter the following settings:

| Name           | Expression | Value     | Description    |
|----------------|------------|-----------|----------------|
| core_width     | w_core_1   | 3.1E-6 m  | Core width     |
| cladding_width | w_clad_1   | 1.55E-4 m | Cladding width |
| element_length | lam0       | 1.55E-6 m | Element length |

Let the other table rows remain unchanged.

- 4 Locate the **Position and Orientation of Output** section. In the **x-displacement** text field, type **-1am0**.
- 5 In the **Rotation angle** text field, type **-90**.
- 6 Locate the **Domain Selections** section. In the table, enter the following settings:

| Name     | Keep | Physics | Contribute to |
|----------|------|---------|---------------|
| Core     |      | √       | Core          |
| Cladding |      | √       | None          |
| All      | √    | √       | Non-PML       |

- 7 Click to select row number 3 in the table.
- 8 Locate the **Boundary Selections** section. Click **New Cumulative Selection**.
- 9 In the **New Cumulative Selection** dialog, type **Straight Waveguide Transverse Perimeter** in the **Name** text field.
- 10 Click **OK**.
- 11 In the **Settings** window for **Part Instance**, locate the **Boundary Selections** section.

**I2** In the table, enter the following settings:

| Name                 | Keep | Physics | Contribute to                           |
|----------------------|------|---------|---|
| Exterior             |      | √       | None                                    |
| Port 1 core          |      | √       | None                                    |
| Port 1 cladding      |      | √       | None                                    |
| Port 1               | √    | √       | None                                    |
| Port 2 core          |      | √       | None                                    |
| Port 2 cladding      |      | √       | None                                    |
| Port 2               |      | √       | None                                    |
| Transverse perimeter |      | √       | Straight Waveguide Transverse Perimeter |

The **Port 1** selection will be used as the selection for the input port in the model. The **Straight Waveguide Transverse Perimeter** cumulative selection will be used when defining the mesh.

**I3** Click  **Build All Objects**.

**I4** Click the  **Zoom Extents** button in the **Graphics** toolbar.

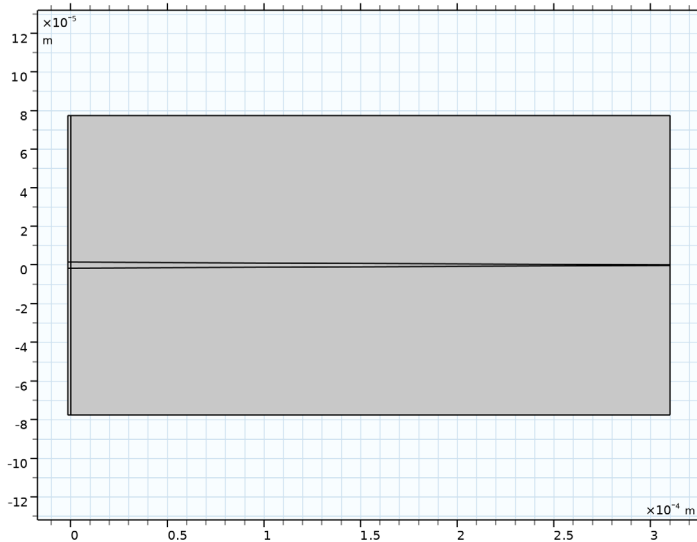

### Input PML

**1** Right-click **Input Waveguide** and choose **Duplicate**.

**2** In the **Settings** window for **Part Instance**, type Input PML in the **Label** text field.

- 3 Locate the **Position and Orientation of Output** section. In the **x-displacement** text field, type  $-2 \cdot 1 \text{am}0$ .
- 4 Locate the **Domain Selections** section. Click **New Cumulative Selection**.
- 5 In the **New Cumulative Selection** dialog, type PML in the **Name** text field.
- 6 Click **OK**.
- 7 In the **Settings** window for **Part Instance**, locate the **Domain Selections** section.
- 8 In the table, enter the following settings:

| Name     | Keep | Physics | Contribute to |
|----------|------|---------|---------------|
| Core     |      | √       | Core          |
| Cladding |      | √       | None          |
| All      | √    | √       | PML           |

The **PML** selection will be used for the Perfectly Matched Layer.

- 9 Locate the **Boundary Selections** section. In the table, enter the following settings:

| Name                 | Keep | Physics | Contribute to                           |
|----------------------|------|---------|---|
| Exterior             |      | √       | None                                    |
| Port 1 core          | √    | √       | None                                    |
| Port 1 cladding      | √    | √       | None                                    |
| Port 1               | √    | √       | None                                    |
| Port 2 core          |      | √       | None                                    |
| Port 2 cladding      |      | √       | None                                    |
| Port 2               |      | √       | None                                    |
| Transverse perimeter |      | √       | Straight Waveguide Transverse Perimeter |

The **Port 1 core**, **Port 1 cladding**, and **Port 1** selections will be used when defining the mesh.

- 10 Click  **Build All Objects**.

II Click the  **Zoom Extents** button in the **Graphics** toolbar.

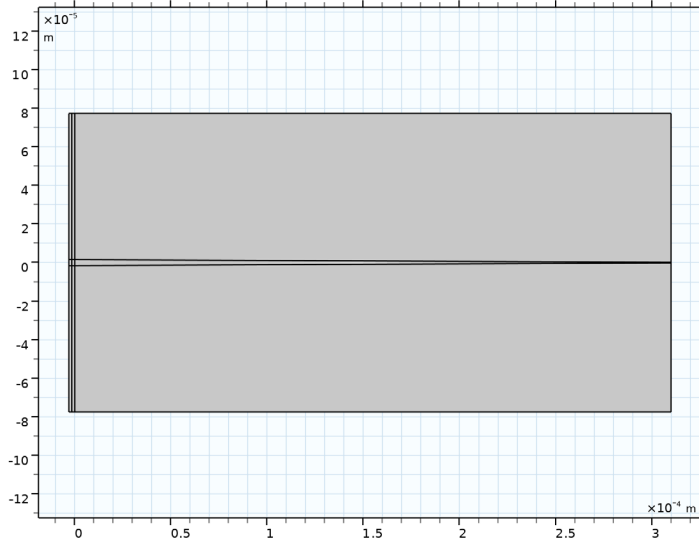

### Output Waveguide

- 1 In the **Model Builder** window, under **Component 1 (comp1) > Geometry 1** right-click **Input Waveguide (pi2)** and choose **Duplicate**.
- 2 In the **Settings** window for **Part Instance**, type Output Waveguide in the **Label** text field.
- 3 Locate the **Input Parameters** section. In the table, enter the following settings:

| Name           | Expression | Value     | Description    |
|----------------|------------|-----------|----------------|
| core_width     | w_core_2   | 3.1E-7 m  | Core width     |
| cladding_width | w_clad_2   | 1.55E-4 m | Cladding width |

Let the other table rows remain unchanged.

- 4 Locate the **Position and Orientation of Output** section. In the **x-displacement** text field, type d\_taper.

5 Locate the **Boundary Selections** section. In the table, enter the following settings:

| Name                 | Keep | Physics | Contribute to                           |
|----------------------|------|---------|---|
| Exterior             |      | √       | None                                    |
| Port 1 core          |      | √       | None                                    |
| Port 1 cladding      |      | √       | None                                    |
| Port 1               |      | √       | None                                    |
| Port 2 core          |      | √       | None                                    |
| Port 2 cladding      |      | √       | None                                    |
| Port 2               | √    | √       | None                                    |
| Transverse perimeter |      | √       | Straight Waveguide Transverse Perimeter |

The **Port 2** selection will be used for the output port.

6 Click  **Build All Objects**.

7 Click the  **Zoom Extents** button in the **Graphics** toolbar.

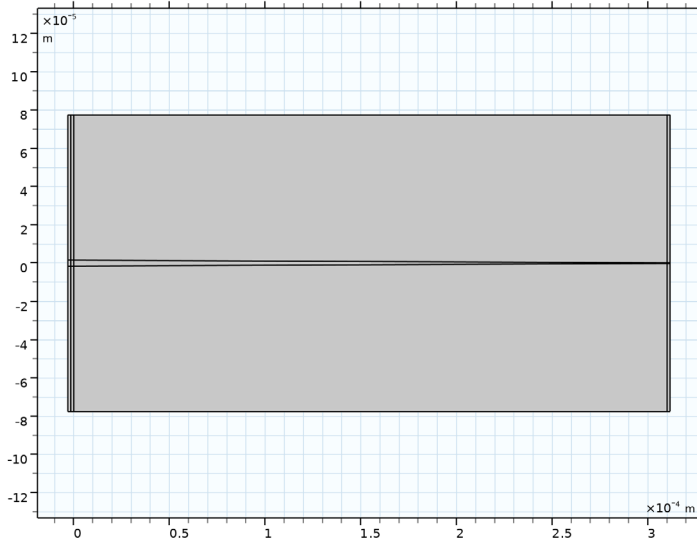

### Output PML

1 In the **Model Builder** window, under **Component 1 (comp1) > Geometry 1** right-click **Input PML (pi3)** and choose **Duplicate**.

2 In the **Settings** window for **Part Instance**, type Output PML in the **Label** text field.

3 Locate the **Input Parameters** section. In the table, enter the following settings:

| Name           | Expression | Value     | Description    |
|----------------|------------|-----------|----------------|
| core_width     | w_core_2   | 3.1E-7 m  | Core width     |
| cladding_width | w_clad_2   | 1.55E-4 m | Cladding width |

Let the other table rows remain unchanged.

4 Locate the **Position and Orientation of Output** section. In the **x-displacement** text field, type `d_taper+1am0`.

5 Locate the **Boundary Selections** section. In the table, enter the following settings:

| Name                 | Keep | Physics | Contribute to                           |
|----------------------|------|---------|---|
| Exterior             |      | √       | None                                    |
| Port 1 core          |      | √       | None                                    |
| Port 1 cladding      |      | √       | None                                    |
| Port 1               |      | √       | None                                    |
| Port 2 core          |      | √       | None                                    |
| Port 2 cladding      |      | √       | None                                    |
| Port 2               |      | √       | None                                    |
| Transverse perimeter |      | √       | Straight Waveguide Transverse Perimeter |

6 Click  **Build All Objects**.

7 Click the  **Zoom Extents** button in the **Graphics** toolbar.

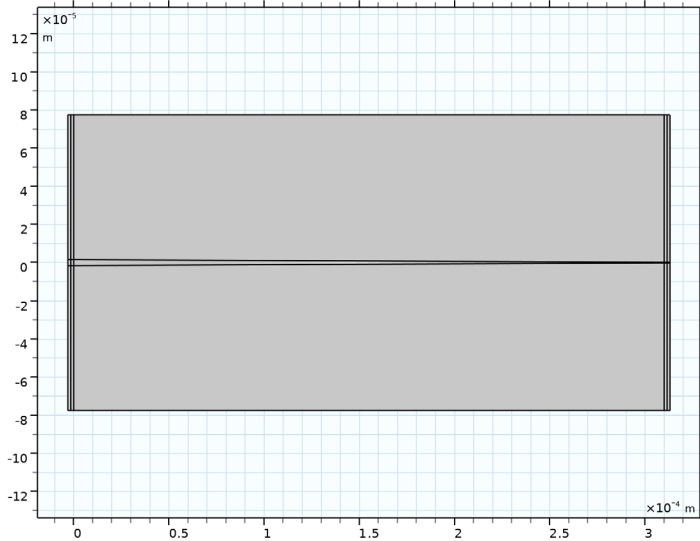

## MATERIALS

### Cladding

- 1 In the **Model Builder** window, under **Component 1 (comp1)** right-click **Materials** and choose **Blank Material**.
- 2 In the **Settings** window for **Material**, type Cladding in the **Label** text field.
- 3 Locate the **Material Contents** section. In the table, enter the following settings:

| Property                    | Variable                     | Value  | Unit | Property group   |
|-----------------------------|------------------------------|--------|------|------------------|
| Refractive index, real part | n_iso ; nii = n_iso, nij = 0 | n_clad | 1    | Refractive index |

### Core

- 1 Right-click **Cladding** and choose **Duplicate**.
- 2 In the **Settings** window for **Material**, type Core in the **Label** text field.

3 Locate the **Geometric Entity Selection** section. From the **Selection** list, choose **Core**.

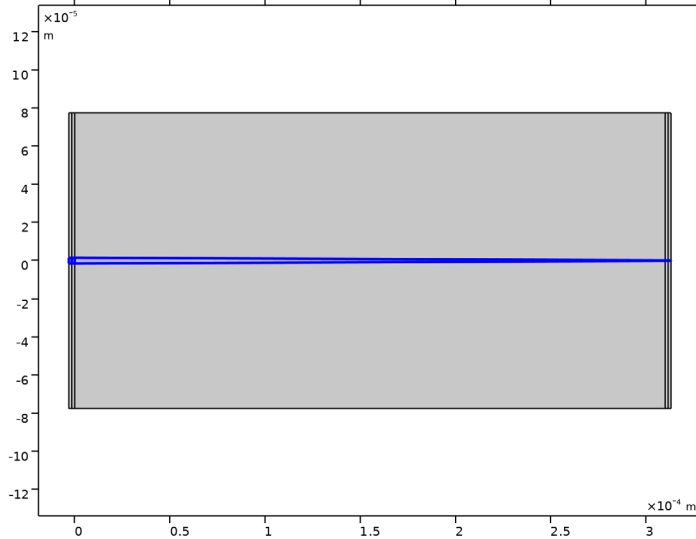

4 Locate the **Material Contents** section. In the table, enter the following settings:

| Property                    | Variable   | Value      | Unit | Property group   |
|-----------------------------|--|------------|------|------------------|
| Refractive index, real part | $n_{iso}$ ; $n_{ii} = n_{iso}$ ,<br>$n_{ij} = 0$ | $n_{core}$ | 1    | Refractive index |

#### DEFINITIONS

*Perfectly Matched Layer 1 (pml1)*

1 In the **Definitions** toolbar, click  **Perfectly Matched Layer**.

2 In the **Settings** window for **Perfectly Matched Layer**, locate the **Domain Selection** section.

3 From the **Selection** list, choose **PML**.

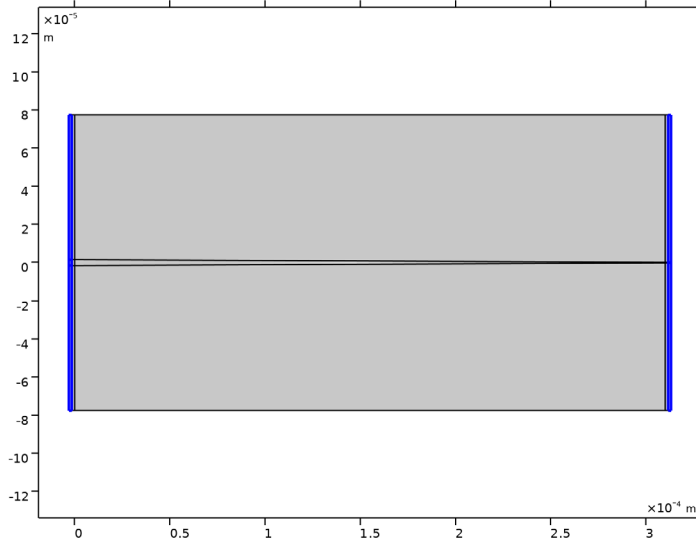

### **ELECTROMAGNETIC WAVES, BEAM ENVELOPES (EWBE)**

- 1 In the **Model Builder** window, under **Component 1 (comp1)** click **Electromagnetic Waves, Beam Envelopes (ewbe)**.
- 2 In the **Settings** window for **Electromagnetic Waves, Beam Envelopes**, locate the **Components** section.
- 3 From the **Electric field components solved for** list, choose **Out-of-plane vector**.
- 4 Locate the **Wave Vectors** section. From the **Number of directions** list, choose **Unidirectional**.
- 5 From the **Type of phase specification** list, choose **User defined**.
- 6 In the  $\phi_1$  text field, type  $\phi_1$ . The variable  $\phi_1$  will also be displayed in orange, as it has not yet been defined.

7 Click to expand the **User-Defined Wave Vector Specification** section. Specify the  $\mathbf{k}_1$  vector as

|    |   |
|----|---|
| kx | x |
| 0  | y |

It is necessary to manually define the wave vector to get the right phase and wave vector in the Perfectly Matched Layer (PML) domains. For more information, see the discussion in the [Model Definition](#) section.

*Port 1*

- 1 In the **Physics** toolbar, click  **Boundaries** and choose **Port**.
- 2 In the **Settings** window for **Port**, locate the **Boundary Selection** section.
- 3 From the **Selection** list, choose **Port 1 (Input Waveguide)**.

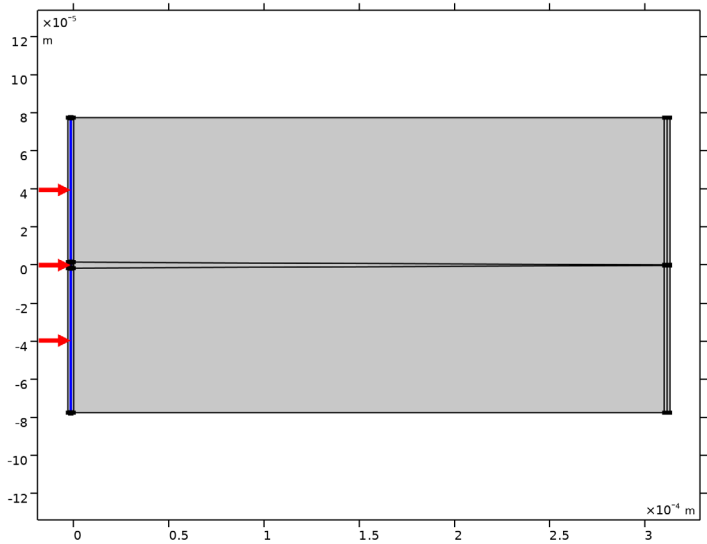

- 4 Locate the **Port Properties** section. From the **Type of port** list, choose **Numeric**.
- 5 Select the **Activate slit condition on interior port** checkbox.
- 6 Click **Toggle Power Flow Direction** to make the arrows in the **Graphics** window point in the positive  $x$  direction (meaning that the power will flow into the tapered waveguide).

*Port 2*

- 1 In the **Physics** toolbar, click  **Boundaries** and choose **Port**.
- 2 In the **Settings** window for **Port**, locate the **Boundary Selection** section.

3 From the **Selection** list, choose **Port 2 (Output Waveguide)**.

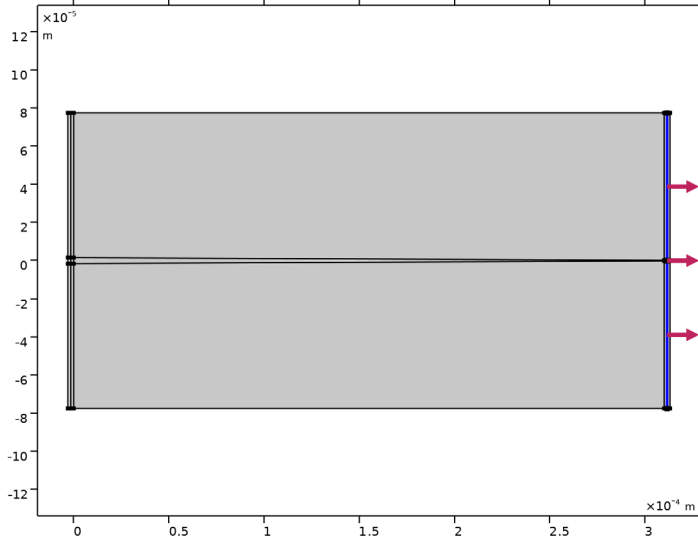

4 Locate the **Port Properties** section. From the **Type of port** list, choose **Numeric**.

5 Select the **Activate slit condition on interior port** checkbox.

6 Click **Toggle Power Flow Direction** to make the arrows in the **Graphics** window point in the positive  $x$  direction (meaning that the power will flow out of the waveguide and into the backing PML).

This port will not absorb any radiation. Instead, all radiation reaching the port will be absorbed by the backing PML. The port, however, will make sure that the proper S-parameter and transmittance variables are defined.

## DEFINITIONS

Next, define the missing phase and wave vector variables. Notice that the expressions below will make the phase variable  $\phi$  continuous everywhere along the waveguide.

### *Input PML*

1 In the **Model Builder** window, under **Component 1 (comp1)** right-click **Definitions** and choose **Variables**.

2 In the **Settings** window for **Variables**, type **Input PML** in the **Label** text field.

3 Locate the **Geometric Entity Selection** section. From the **Geometric entity level** list, choose **Domain**.

4 From the **Selection** list, choose **All (Input PML)**.

5 Click the  **Zoom Extents** button in the **Graphics** toolbar.

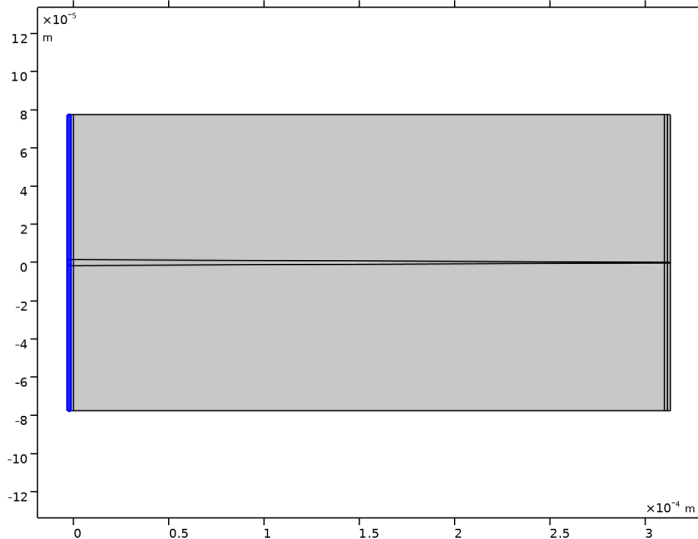

6 Locate the **Variables** section. In the table, enter the following settings:

| Name | Expression  | Unit  | Description |
|------|-------------|-------|-------------|
| kx   | ewbe.beta_1 | rad/m |             |
| phi  | kx*pm11.x   | rad/m |             |

Above, the phase  $\phi$  is defined using the complex scaled PML coordinate  $pm11 \cdot x$ . This will make the field in the PML attenuate. The wave vector in the  $x$  direction,  $kx$ , is defined by the propagation constant for the input port.

#### *Input Waveguide*

- 1 Right-click **Input PML** and choose **Duplicate**.
- 2 In the **Settings** window for **Variables**, type *Input Waveguide* in the **Label** text field.

- 3** Locate the **Geometric Entity Selection** section. From the **Selection** list, choose **All (Input Waveguide)**.

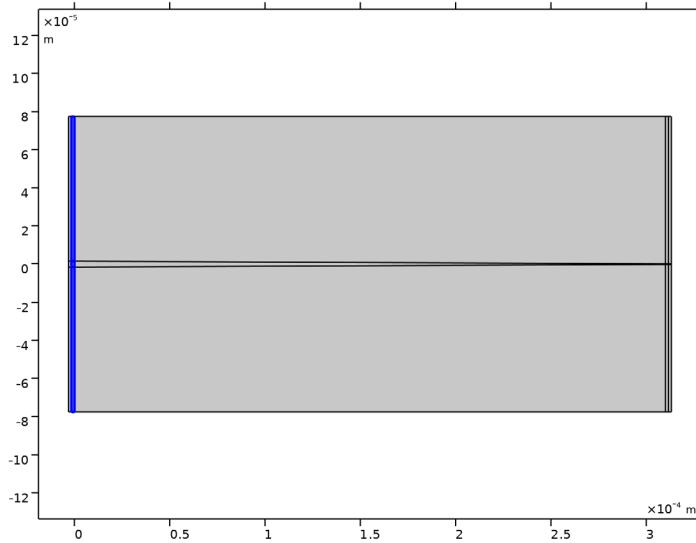

- 4** Locate the **Variables** section. In the table, enter the following settings:

| Name | Expression | Unit | Description |
|------|------------|------|-------------|
| phi  | kx*x       | rad  |             |

Let the setting for kx remain unchanged.

#### *Tapered Waveguide*

- 1** Right-click **Input Waveguide** and choose **Duplicate**.
- 2** In the **Settings** window for **Variables**, type Tapered Waveguide in the **Label** text field.

- 3 Locate the **Geometric Entity Selection** section. From the **Selection** list, choose **All (Tapered Waveguide)**.

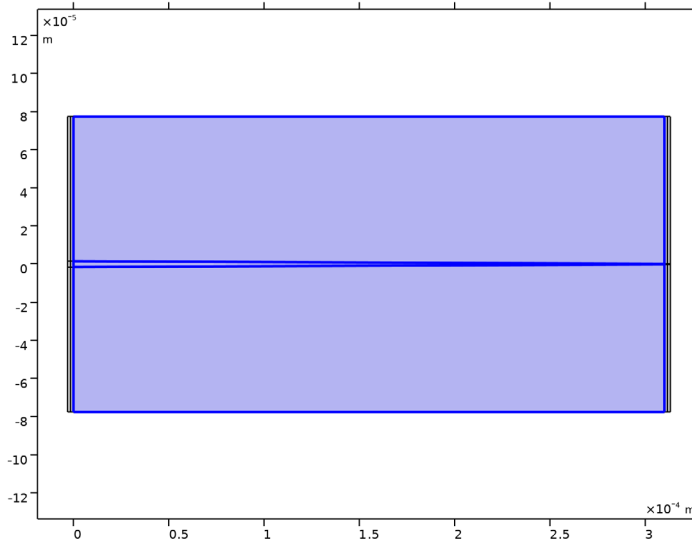

- 4 Locate the **Variables** section. In the table, enter the following settings:

| Name | Expression   | Unit  | Description |
|------|--|-------|-------------|
| kx   | $ewbe.beta_1 + (ewbe.beta_2 - ewbe.beta_1) * x / d\_taper$ | rad/m |             |
| phi  | $(kx + ewbe.beta_1) * x / 2$                               | rad   |             |

The wave vector component  $kx$  changes value linearly from the propagation constant for the input port to that for the output port. Thereby, the phase  $\phi$  will depend quadratically on the propagation coordinate,  $x$ .

#### *Output Waveguide*

- 1 Right-click **Tapered Waveguide** and choose **Duplicate**.
- 2 In the **Settings** window for **Variables**, type Output Waveguide in the **Label** text field.

- 3 Locate the **Geometric Entity Selection** section. From the **Selection** list, choose **All (Output Waveguide)**.

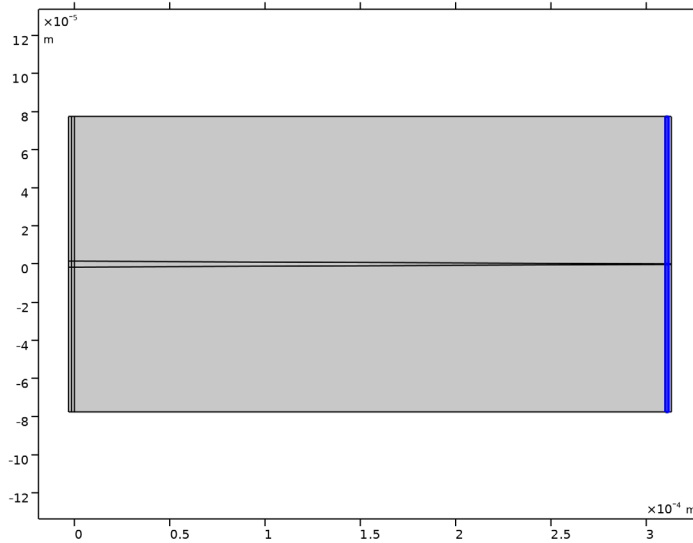

- 4 Locate the **Variables** section. In the table, enter the following settings:

| Name | Expression   | Unit  | Description |
|------|--|-------|-------------|
| kx   | ewbe.beta_2  | rad/m |             |
| phi  | $kx * (x - d\_taper) + (ewbe.beta\_1 + ewbe.beta\_2) * d\_taper / 2$ | rad   |             |

#### Output PML

- 1 Right-click **Output Waveguide** and choose **Duplicate**.
- 2 In the **Settings** window for **Variables**, type Output PML in the **Label** text field.

- 3 Locate the **Geometric Entity Selection** section. From the **Selection** list, choose **All (Output PML)**.

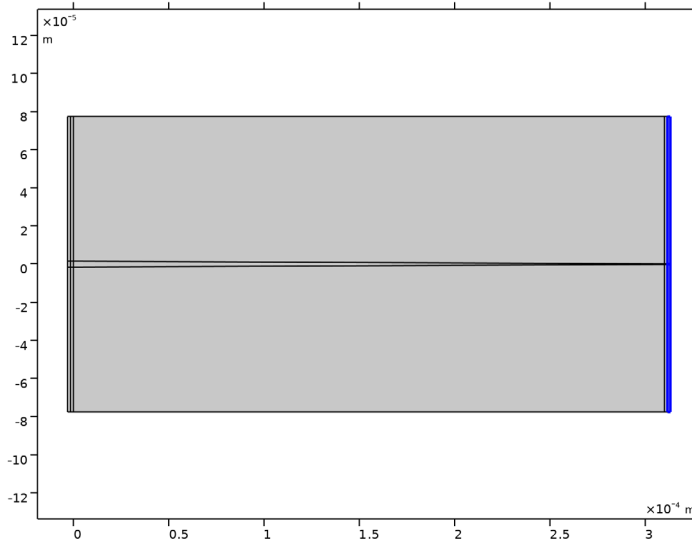

- 4 Locate the **Variables** section. In the table, enter the following settings:

| Name | Expression   | Unit | Description |
|------|--|------|-------------|
| phi  | $kx*(pm11.x-d\_taper-lam0)+$<br>$(ewbe.beta\_1+ewbe.beta\_2)*d\_taper/$<br>$2+kx*lam0$ | rad  |             |

Here again, it is important to use the complex scaled  $x$  coordinate from the PML,  $pm11.x$ , when defining the phase. This will give the proper attenuation of the field in the PML.

Let the setting for  $kx$  remain unchanged.

## MESH 1

Now, define the mesh, using the selections defined when the geometry was created.

*Edge 1*

- 1 In the **Mesh** toolbar, click  **More Generators** and choose **Edge**.
- 2 In the **Settings** window for **Edge**, locate the **Boundary Selection** section.

**3** From the **Selection** list, choose **Port I (Input PML)**.

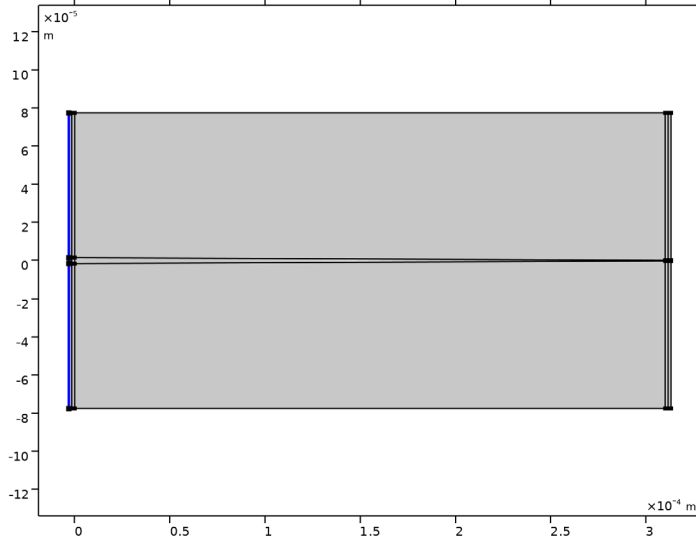

#### *Distribution 1*

**1** Right-click **Edge I** and choose **Distribution**.

**2** In the **Settings** window for **Distribution**, locate the **Boundary Selection** section.

**3** From the **Selection** list, choose **Port I cladding (Input PML)**.

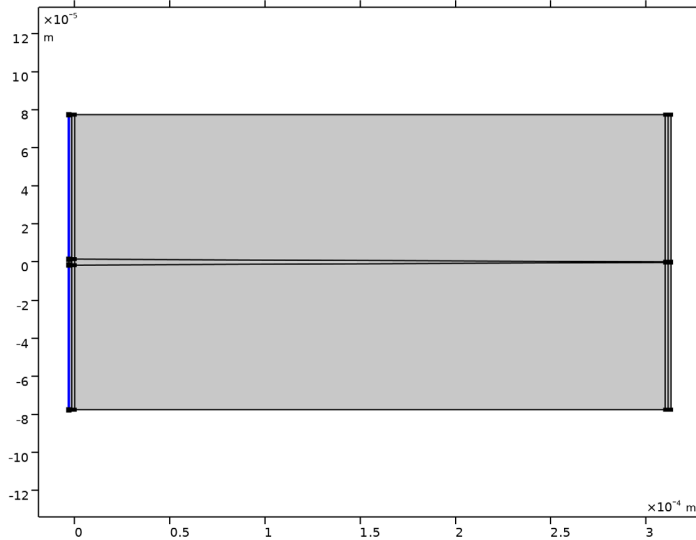

- 4 Locate the **Distribution** section. In the **Number of elements** text field, type 50.

#### *Distribution 2*

- 1 Right-click **Distribution 1** and choose **Duplicate**.
- 2 In the **Settings** window for **Distribution**, locate the **Boundary Selection** section.
- 3 From the **Selection** list, choose **Port 1 core (Input PML)**. This is the leftmost boundary adjacent to the core domain.

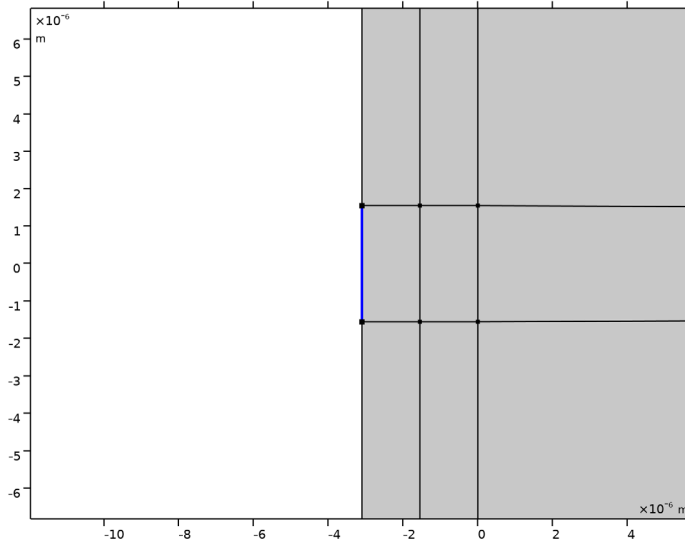

- 4 Locate the **Distribution** section. In the **Number of elements** text field, type 10.

#### *Mapped 1*

- 1 In the **Mesh** toolbar, click  **Mapped**.
- 2 In the **Settings** window for **Mapped**, click to expand the **Reduce Element Skewness** section.
- 3 Select the **Adjust edge mesh** checkbox. This makes sure the PML mesh, especially on the input side, is not skewed.

#### *Distribution 1*

- 1 Right-click **Mapped 1** and choose **Distribution**.
- 2 In the **Settings** window for **Distribution**, locate the **Boundary Selection** section.

- 3** From the **Selection** list, choose **Straight Waveguide Transverse Perimeter**. The selected entities are the top and bottom boundaries adjacent to the straight (nontapered) waveguide domains.

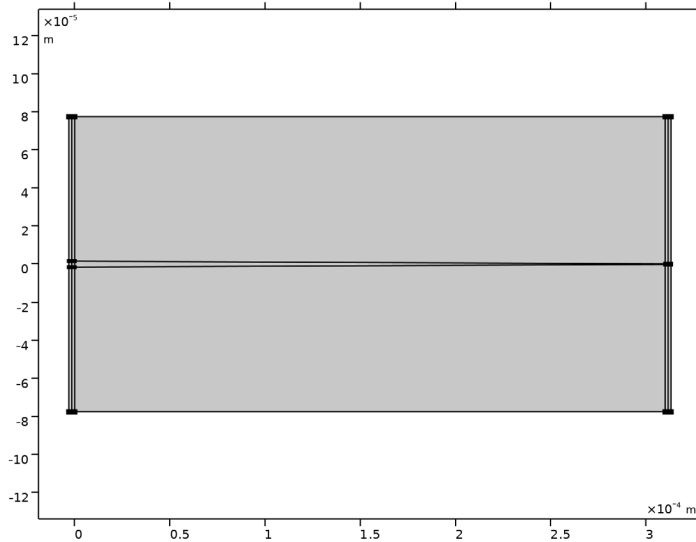

- 4** Locate the **Distribution** section. In the **Number of elements** text field, type 10.

*Distribution 2*

- 1** Right-click **Distribution 1** and choose **Duplicate**.
- 2** In the **Settings** window for **Distribution**, locate the **Boundary Selection** section.

**3** From the **Selection** list, choose **Transverse perimeter (Tapered Waveguide)**.

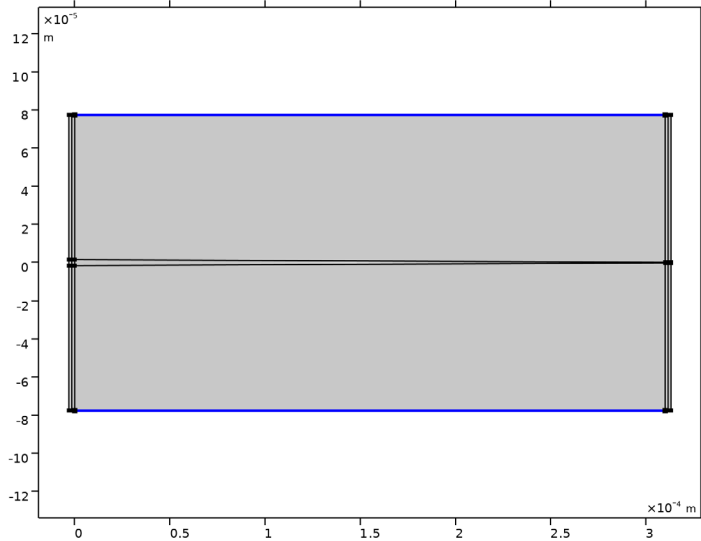

**4** Locate the **Distribution** section. In the **Number of elements** text field, type  $\max(10, \text{round}(n_{\text{taper}}/20))$ .

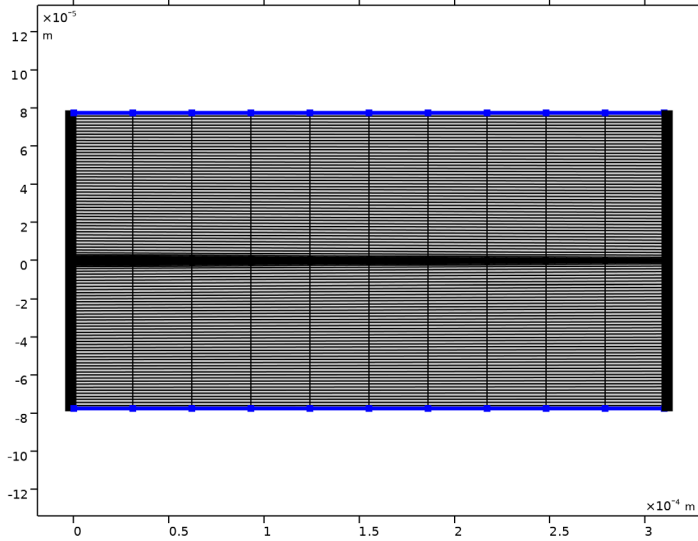

The expression above will allow for a few more layers in the propagation direction for the longest taper lengths.

5 Click  **Build All**.



## STUDY 1

### Parametric Sweep

- 1 In the **Study** toolbar, click  **Parametric Sweep**.
- 2 In the **Settings** window for **Parametric Sweep**, locate the **Study Settings** section.
- 3 Click  **Add**.
- 4 In the table, enter the following settings:

| Parameter name                               | Parameter value list | Parameter unit |
|--|----------------------|----------------|
| n_taper (Taper length in vacuum wavelengths) |                      |                |

- 5 Click  **Range**.
- 6 In the **Range** dialog, type -1 in the **Start** text field.
- 7 In the **Step** text field, type 0.25.
- 8 In the **Stop** text field, type 4.
- 9 From the **Function to apply to all values** list, choose **exp10(x) – Exponential function (base 10)**.

**10** Click **Replace**.

This will create a sweep of the taper length from a tenth of a wavelength to 10 000 wavelengths.

*Step 2: Boundary Mode Analysis*

**1** In the **Study** toolbar, click  **More Study Steps** and choose **Other > Boundary Mode Analysis**.

**2** In the **Settings** window for **Boundary Mode Analysis**, locate the **Study Settings** section.

**3** In the **Mode analysis frequency** text field, type  $f_0$ .

**4** In the **Search for modes around shift** text field, type  $n_{\text{core}}$ .

*Step 3: Boundary Mode Analysis 1*

**1** Right-click **Study 1 > Step 2: Boundary Mode Analysis** and choose **Duplicate**.

**2** In the **Settings** window for **Boundary Mode Analysis**, locate the **Study Settings** section.

**3** In the **Port name** text field, type 2.

*Step 1: Wavelength Domain*

**1** In the **Model Builder** window, under **Study 1** right-click **Step 1: Wavelength Domain** and choose **Move Down**. Repeat this operation once more. You can also move the **Step 1: Wavelength Domain** node down to the last position in the list by selecting it and clicking **Ctrl+Down** twice.

**2** In the **Settings** window for **Wavelength Domain**, locate the **Study Settings** section.

**3** In the **Wavelengths** text field, type  $1\lambda_0$ .

**4** In the **Study** toolbar, click  **Compute**.

## RESULTS

*Electric Field (ewbe)*

1 Click the  **Zoom Extents** button in the **Graphics** toolbar.

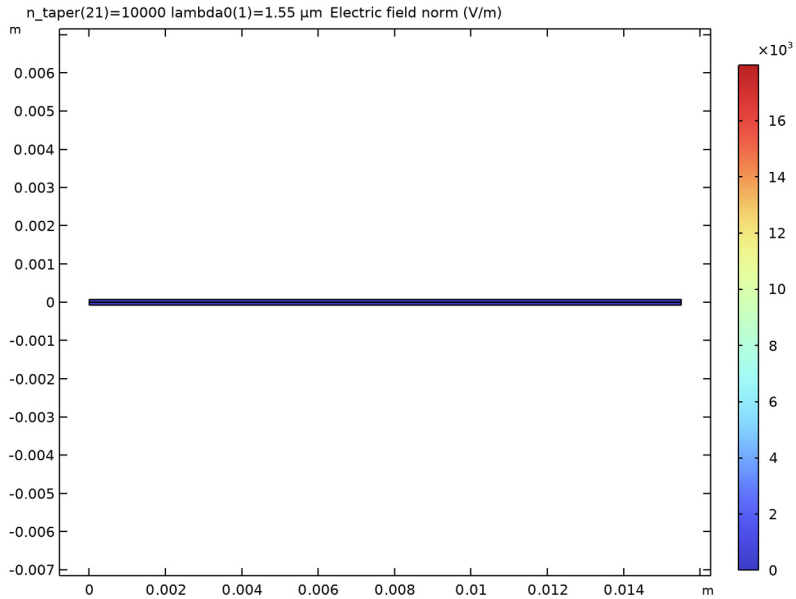

The waveguide structure is very long and narrow. To make it easier to inspect the result, first remove the PML domains from the plot and then update the view settings.

- 2 In the **Settings** window for **2D Plot Group**, click to expand the **Selection** section.
- 3 From the **Geometric entity level** list, choose **Domain**.

4 From the **Selection** list, choose **Non-PML**.

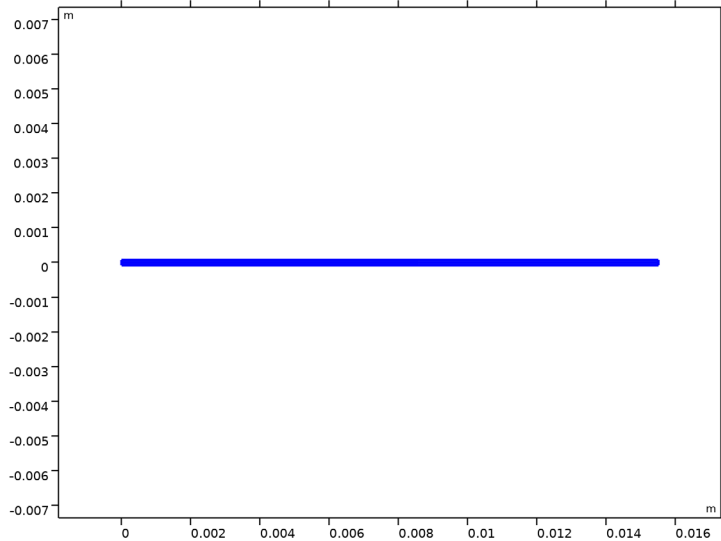

5 Select the **Apply to dataset edges** checkbox.

#### *Height Expression 1*

- 1 In the **Model Builder** window, expand the **Electric Field (ewbe)** node.
- 2 Right-click **Electric Field** and choose **Height Expression**.
- 3 In the **Settings** window for **Height Expression**, click to expand the **View** section.
- 4 Click  **Go to Source**.

#### *Camera*

- 1 In the **Model Builder** window, expand the **View 3D 4** node, then click **Camera**.
- 2 In the **Settings** window for **Camera**, locate the **Camera** section.
- 3 From the **View scale** list, choose **Automatic**.
- 4 From the **Automatic** list, choose **Anisotropic**.
- 5 In the **z weight** text field, type 0.2.
- 6 Select the **Automatic update** checkbox.
- 7 Click  **Update**.

#### *Electric Field (ewbe)*

- 1 Click the  **Zoom Extents** button in the **Graphics** toolbar.

2 In the **Model Builder** window, under **Results** click **Electric Field (ewbe)**.

$n_{\text{taper}}(21)=10000$   $\lambda_{\text{bda}0}(1)=1.55 \mu\text{m}$  Electric field norm (V/m)

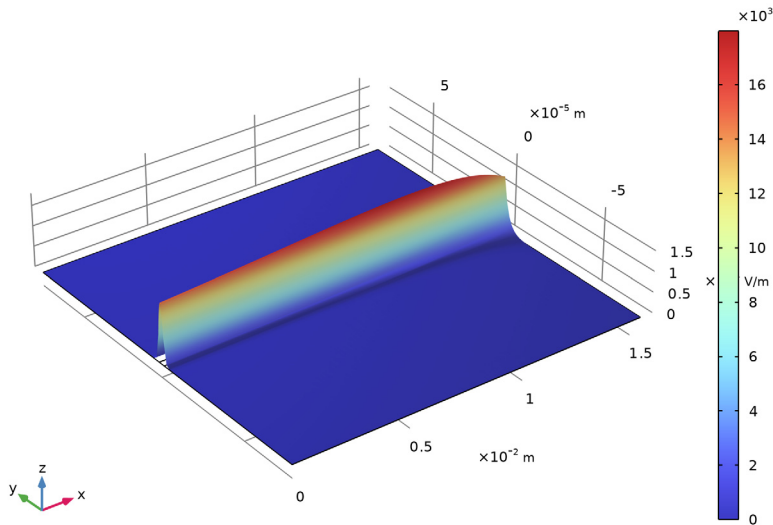

To scan through the results for the shorter taper lengths, just repeatedly click the **Plot Previous** button in the **Settings** window for **2D Plot Group**.



*Transmittance (ewbe)*

Edit this plot to only display the transmittance, as that is the most relevant property to inspect.

- 1 In the **Model Builder** window, under **Results** click **Reflectance, Transmittance, and Absorptance (ewbe)**.
- 2 In the **Settings** window for **ID Plot Group**, type **Transmittance (ewbe)** in the **Label** text field.
- 3 Locate the **Plot Settings** section. In the **y-axis label** text field, type **Transmittance**.
- 4 Locate the **Axis** section. Select the **x-axis log scale** checkbox.
- 5 Locate the **Legend** section. Clear the **Show legends** checkbox.

*Global 1*

- 1 In the **Model Builder** window, expand the **Transmittance (ewbe)** node, then click **Global 1**.
- 2 In the **Settings** window for **Global**, locate the **y-Axis Data** section.
- 3 In the table, click to select the cell at row number 1 and column number 1.

- 4 Click  **Delete**.
- 5 In the table, click to select the cell at row number 2 and column number 1.
- 6 Click  **Delete**. Repeat this click once, so only the transmittance row remains in the table.
- 7 In the **Transmittance (ewbe)** toolbar, click  **Plot**.

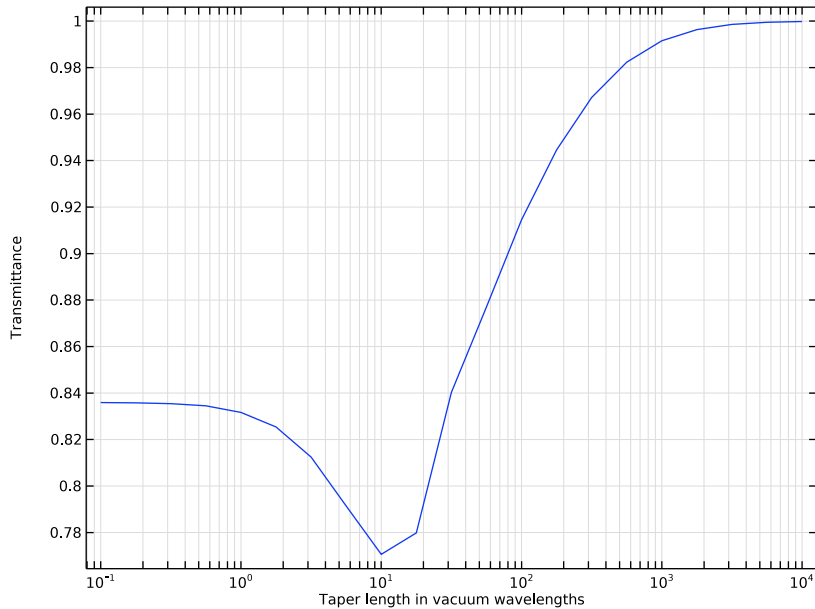

The transmittance is not dependent of the taper length for very short taper lengths. For very long tapers, the adiabatic limit is reached where the field remains in the lowest order mode even though the waveguide width changes. In this regime, the transmission is asymptotically approaching one.

#### *Electric Mode Field, Port 1 (ewbe)*

Finally, inspect the mode fields for the input and output ports.

- 1 In the **Model Builder** window, under **Results** click **Electric Mode Field, Port 1 (ewbe)**.
- 2 In the **Settings** window for **ID Plot Group**, locate the **Data** section.
- 3 From the **Parameter selection (n\_taper)** list, choose **First** to just plot one of the curves since they are all the same.

### Line Graph 1

- 1 In the **Model Builder** window, expand the **Electric Mode Field, Port 1 (ewbe)** node, then click **Line Graph 1**.
- 2 In the **Settings** window for **Line Graph**, locate the **x-Axis Data** section.
- 3 From the **Parameter** list, choose **Expression**.
- 4 In the **Expression** text field, type  $y$ .
- 5 In the **Electric Mode Field, Port 1 (ewbe)** toolbar, click  **Plot**.

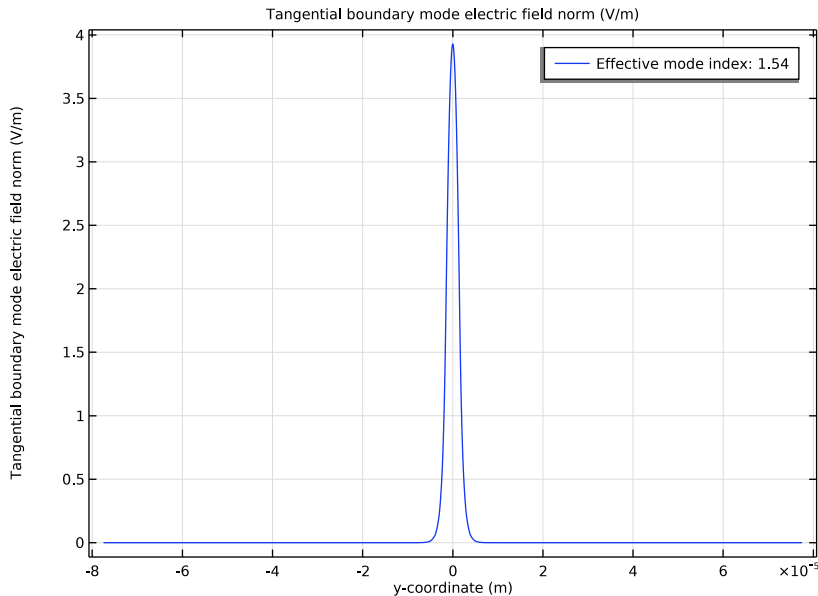

### Electric Mode Field, Port 2 (ewbe)

- 1 In the **Model Builder** window, under **Results** click **Electric Mode Field, Port 2 (ewbe)**.
- 2 In the **Settings** window for **ID Plot Group**, locate the **Data** section.
- 3 From the **Parameter selection (n\_taper)** list, choose **First**.

### Line Graph 1

- 1 In the **Model Builder** window, expand the **Electric Mode Field, Port 2 (ewbe)** node, then click **Line Graph 1**.
- 2 In the **Settings** window for **Line Graph**, locate the **x-Axis Data** section.
- 3 From the **Parameter** list, choose **Expression**.
- 4 In the **Expression** text field, type  $y$ .

5 In the **Electric Mode Field, Port 2 (ewbe)** toolbar, click  **Plot**.

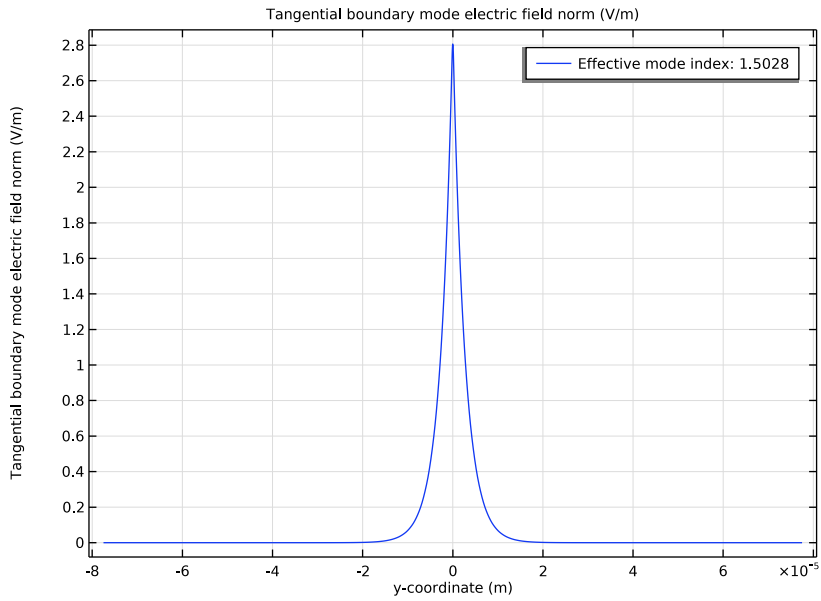

The effective index for this mode is just slightly larger than the cladding refractive index. From the plot it is clear that the mode at the output port is very loosely coupled to the core region.