



Model created in COMSOL Multiphysics 6.4

Mach-Zehnder Modulator

Introduction

Optical modulators are used for electrically controlling the output amplitude or the phase of the light wave passing through the device. To reduce the device size and the driving voltage, waveguide-based modulators are used for communication applications.

To control the optical properties with an external electric signal, the electro-optic effect, or Pockels effect, is used, where the birefringence of the crystal changes proportionally to the applied electric field. A refractive index change results in a change of the phase of the wave passing through the crystal. If you combine two waves with different phase change, you can interferometrically get an amplitude modulation.

The device in [Figure 1](#) is a Mach-Zehnder modulator. The input wave is launched into a directional coupler. The power of the input is split equally into the two output waveguides of the first directional coupler. Those two waveguides form the two arms of a Mach-Zehnder interferometer. On one of the arms, you can apply an electric field to modify the refractive index in the material and, thus, modify the phase for the wave propagating through that arm. The two waves are then combined into another 50/50 directional coupler. By changing the applied voltage you can continuously control the amount of light exiting from the two output waveguides.

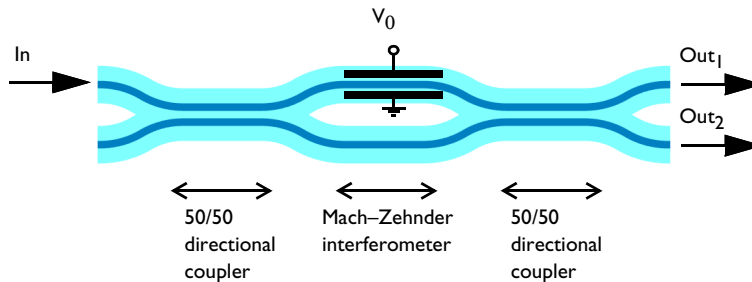

Figure 1: Schematic drawing of the Mach-Zehnder modulator.

A common material for fabricating waveguide modulators is lithium niobate, LiNbO_3 . Lithium niobate is a ferroelectric crystal that exhibits uniaxial birefringence. Waveguide structures can be fabricated by either indiffusion of Ti into the core regions or by annealed proton exchange, where lithium ions are exchanged with protons from an acid bath.

Model Definition

This application shows how the Electromagnetic Waves, Beam Envelopes interface can be combined with the Electrostatics interface to perform simulations of the properties of an optical waveguide modulator. The model is implemented in a 2D geometry, but could be extended to a full 3D simulation.

The Electromagnetic Waves, Beam Envelopes interface is formulated assuming that the electric field is defined as the product of a slowly varying envelope function and a rapidly varying phase function

$$\mathbf{E} = \mathbf{E}_1 \exp(-j\mathbf{k} \cdot \mathbf{r})$$

where \mathbf{E}_1 is the envelope function, \mathbf{k} is a wave vector and \mathbf{r} is the position. If \mathbf{k} is properly selected for the problem, the envelope function \mathbf{E}_1 has a spatial variation occurring on a length scale much larger than the wavelength. A good assumption, for this application, is that the wave is well approximated in the straight domains using the wave vector for the incident mode, β . However, in the waveguide bends the wave vector can be written as

$$\beta_2 = \beta(\cos \alpha \mathbf{x} + \sin \alpha \mathbf{y})$$

where $\beta = k_0 n_{\text{eff}}$ is the propagation constant for the mode, k_0 is the vacuum wave number, n_{eff} is the effective index of the waveguide mode, α is the angle from the x -axis, and \mathbf{x} and \mathbf{y} are the unit vectors in the x and y directions, respectively.

The wave vector difference is thus

$$\beta_2 - \beta = \beta((\cos \alpha - 1)\mathbf{x} + \sin \alpha \mathbf{y})$$

It is the wave vector difference that determines the phase variation for the envelope field. Thus, you must make sure that the phase variation is well resolved by the mesh. For instance,

$$(\beta_2 - \beta) \cdot \Delta \mathbf{r} \leq 2\pi/N$$

where N is a suitably large number, for instance 6. From the relations above, you get that the maximum mesh element sizes in the x and y directions should be

$$h_{x, \max} = \frac{\lambda}{N n_{\text{eff}}(1 - \cos \alpha)}$$

and

$$h_{y, \max} = \frac{\lambda}{Nn_{\text{eff}}\sin\alpha}$$

Results and Discussion

The first part of the application is to define a minimum bend radius that provides low loss. [Figure 2](#) shows the power transmission for an S-shaped bend. As seen, a bend radius of 2.5 mm gives a transmission of approximately 95% of the power. Accept the 5% loss and fix the bend radius to be 2.5 mm.

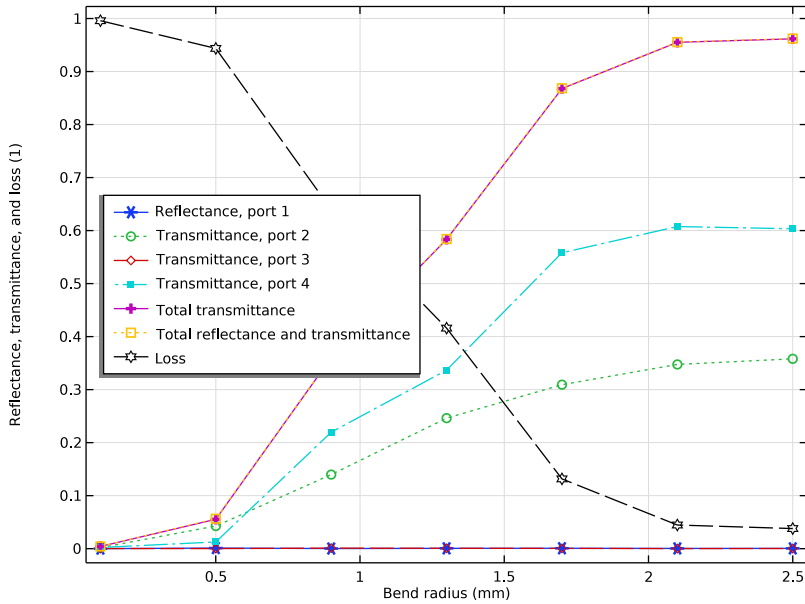

Figure 2: The transmission through an S-bent waveguide versus the radius of curvature for the bend.

Figure 3 shows the electric field norm for the wave propagating in the S-shaped bend, for a bend radius of 2.5 mm. As seen, the wave follows the waveguide in the bend, as expected.

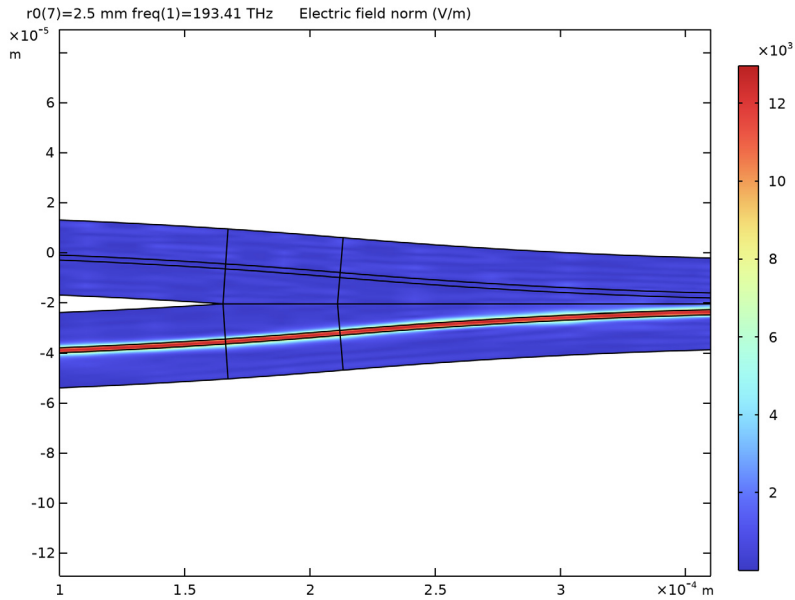

Figure 3: The electric field norm for the wave in the S-bent waveguide for a radius of curvature of 2.5 mm.

You want the directional coupler structures to operate as 50/50 couplers. That is, half of the incident power should exit from each of the two output arms. To find the coupler length where this condition is met, monitor the power difference in the two arms of the Mach–Zehnder interferometer and sweep the length of the directional coupler. Figure 4

shows the result of the parameter sweep. A coupler length of 380 μm gives zero power difference between the two arms. That is, the power is the same in the two arms.

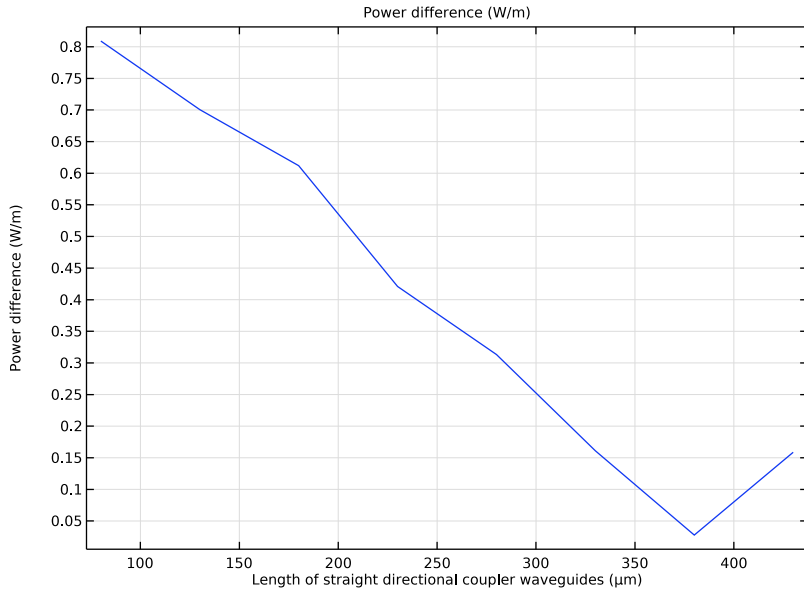

Figure 4: The absolute value of the power difference between the two waveguide arms in the Mach-Zehnder interferometer versus the length of the directional coupler.

Figure 5 shows that the electric field norms for the two arms indeed seem to be the same.

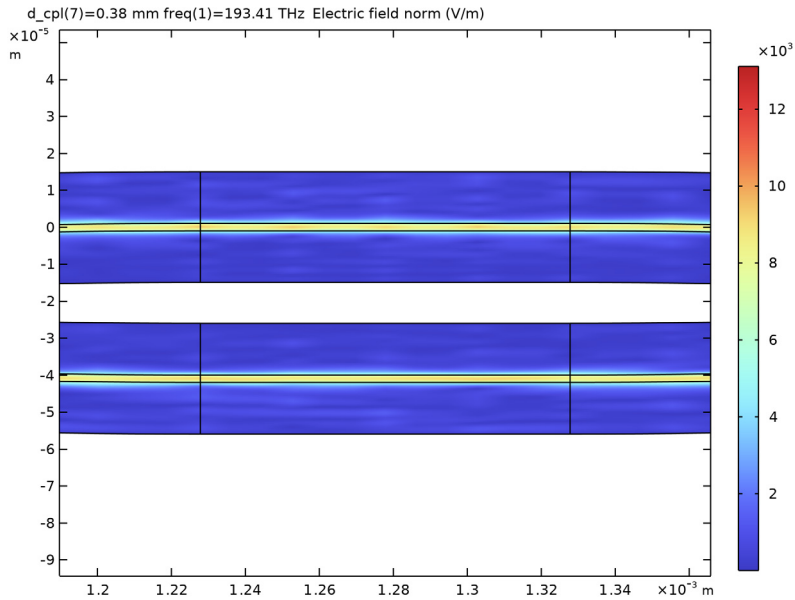

Figure 5: The electric field norm in the two waveguide arms of the Mach-Zehnder interferometer. As shown, the fields are almost the same for a directional coupler length of $380 \mu\text{m}$.

Finally, a voltage is applied across the waveguide in one of the arms. The voltage modifies the refractive index in the arm and, thus, there is a phase difference between the wave propagating through the two Mach-Zehnder interferometer arms. As expected, Figure 6 shows that the wave can be switched between the two output waveguides by tuning the applied voltage. Thus, if all input and output ports are connected to other waveguides or

fibers, you can use the device as a spatial switch. However, if only one input port and one output port are active, the device operates as an amplitude modulator.

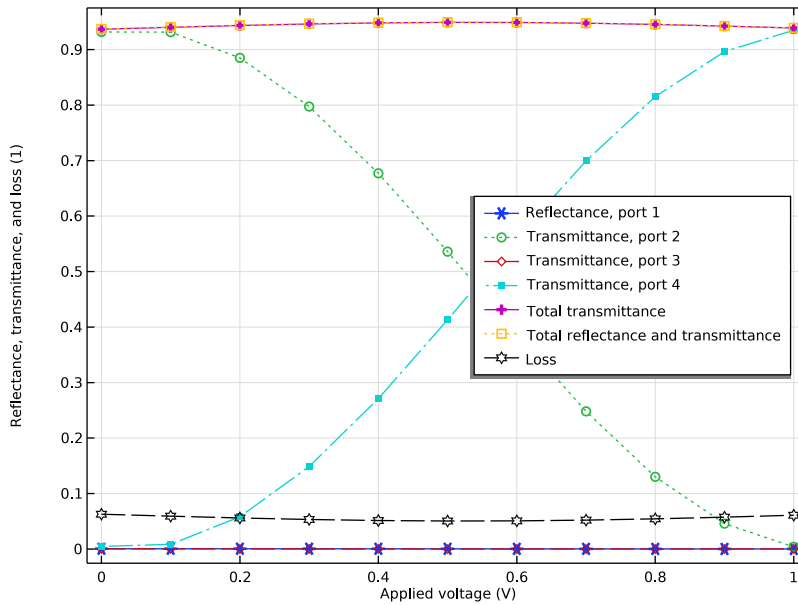

Figure 6: The transmission to the upper (port 2) and the lower (port 4) output waveguide versus the applied voltage, V_0 .

Notes About the COMSOL Implementation

The geometry is built using the Wave Optics Module part library, by loading special parts for straight waveguides and directional couplers.

Application Library path: Wave_Optics_Module/Modulators_and_Switches/
mach_zehnder_modulator

Modeling Instructions



First add the physics interface and the study sequence.

From the **File** menu, choose **New**.

NEW

In the **New** window, click  **Model Wizard**.

MODEL WIZARD

- 1 In the **Model Wizard** window, click  **2D**.
- 2 In the **Select Physics** tree, select **Optics > Wave Optics > Electromagnetic Waves, Beam Envelopes (ewbe)**.
- 3 Click **Add**.
- 4 Click  **Study**.
- 5 In the **Select Study** tree, select **Preset Studies for Selected Physics Interfaces > Boundary Mode Analysis**.
- 6 Click  **Done**.

GLOBAL DEFINITIONS



First load some parameters from file. The parameters are used when defining the physics and the mesh.

General Parameters

- 1 In the **Model Builder** window, under **Global Definitions** click **Parameters I**.
- 2 In the **Settings** window for **Parameters**, type General Parameters in the **Label** text field.
- 3 Locate the **Parameters** section. Click  **Load from File**.
- 4 Browse to the model's Application Libraries folder and double-click the file `mach_zehnder_modulator_parameters.txt`.

Geometry Parameters

Also load the geometry parameters from file. The parameters define the sizes and locations for the geometric objects.

- 1 In the **Home** toolbar, click  **Parameters** and choose **Add > Parameters**.
- 2 In the **Settings** window for **Parameters**, type Geometry Parameters in the **Label** text field.
- 3 Locate the **Parameters** section. Click  **Load from File**.

- 4 Browse to the model's Application Libraries folder and double-click the file `mach_zehnder_modulator_geometry_parameters.txt`.



The length of the Mach-Zehnder arms has purposely been set to a small value, to make it easier to build the geometry. You will later change the length to a realistic value.

In a later study, you will optimize the radius of curvature for the S-bends in the directional couplers, to find a value that is a good compromise between insertion loss and device size.

The geometry is built using parts from the Wave Optics Module part library.

First, add a directional coupler part.

PART LIBRARIES

- 1 In the **Home** toolbar, click  **Windows** and choose **Part Libraries**.
- 2 In the **Part Libraries** window, select **Wave Optics Module** > **Slab Waveguides** > **slab_waveguide_s_bend_directional_coupler** in the tree.
- 3 Click  **Add to Geometry**.

GEOMETRY I

Slab Waveguide S-Bend Directional Coupler I (pi1)

- 1 In the **Model Builder** window, under **Component 1 (comp1)** > **Geometry 1** click **Slab Waveguide S-Bend Directional Coupler I (pi1)**.
- 2 In the **Settings** window for **Part Instance**, locate the **Input Parameters** section.
- 3 In the table, enter the following settings:

Name	Expression	Value	Description
core_width	w	2E-6 m	Core width
cladding_width	w_tot	3E-5 m	Cladding width
port_core_separation	d_pcc	4.1E-5 m	Port core separation
coupler_core_separation	d_cc	5E-6 m	Core separation in coupler region
coupler_length	d_cp1	9E-5 m	Coupler length
element_length	d_dc	2.5584E-4 m	Element length

- 4 Locate the **Position and Orientation of Output** section. In the **Rotation angle** text field, type -90.
- 5 Click  **Build All Objects**.

6 Click the  **Zoom Extents** button in the **Graphics** toolbar.

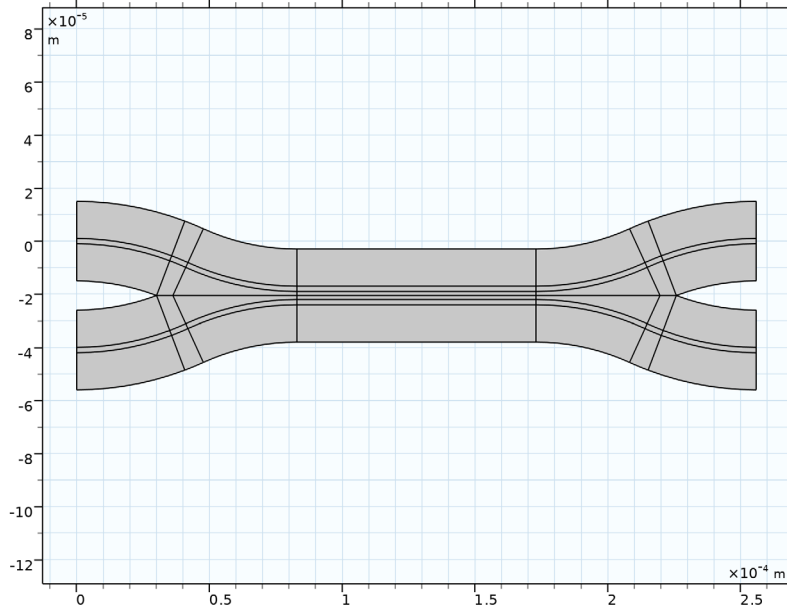

The part contains predefined selections that can be used for assigning selections to boundary conditions, materials and mesh features. Add cumulative selections for the core and the cladding domain selections.

7 Click to expand the **Domain Selections** section. Click **New Cumulative Selection**.

8 In the **New Cumulative Selection** dialog, type **Core** in the **Name** text field.

9 Click **OK**.

10 In the **Settings** window for **Part Instance**, locate the **Domain Selections** section.

11 Click **New Cumulative Selection**.

12 In the **New Cumulative Selection** dialog, type **Cladding** in the **Name** text field.

13 Click **OK**.

14 In the **Settings** window for **Part Instance**, locate the **Domain Selections** section.

15 In the table, enter the following settings:

Name	Keep	Physics	Contribute to
Core		√	Core
Cladding		√	Cladding

Add a new cumulative selection for all exterior boundaries, except the port boundaries.

16 Click to expand the **Boundary Selections** section. Click **New Cumulative Selection**.

17 In the **New Cumulative Selection** dialog, type Transverse Perimeter in the **Name** text field.

18 Click **OK**.

19 In the **Settings** window for **Part Instance**, locate the **Boundary Selections** section.

20 In the table, enter the following settings:

Name	Keep	Physics	Contribute to
Transverse perimeter		√	Transverse Perimeter

PART LIBRARIES

Next, add a straight waveguide part.

1 In the **Geometry** toolbar, click  **Part Libraries**.

2 In the **Part Libraries** window, select **Wave Optics Module > Slab Waveguides > slab_waveguide_straight** in the tree.

3 Click  **Add to Geometry**.

GEOMETRY I



Slab Waveguide Straight I (pi2)

1 In the **Model Builder** window, under **Component I (comp1) > Geometry I** click **Slab Waveguide Straight I (pi2)**.

2 In the **Settings** window for **Part Instance**, locate the **Input Parameters** section.

3 In the table, enter the following settings:

Name	Expression	Value	Description
core_width	w	2E-6 m	Core width
cladding_width	w_tot	3E-5 m	Cladding width
element_length	d0	3.1E-6 m	Element length

- 4 Locate the **Position and Orientation of Output** section. In the **x-displacement** text field, type -d0.
- 5 In the **Rotation angle** text field, type -90.
- 6 Click  **Build All Objects**.
- 7 Click the  **Zoom Extents** button in the **Graphics** toolbar.

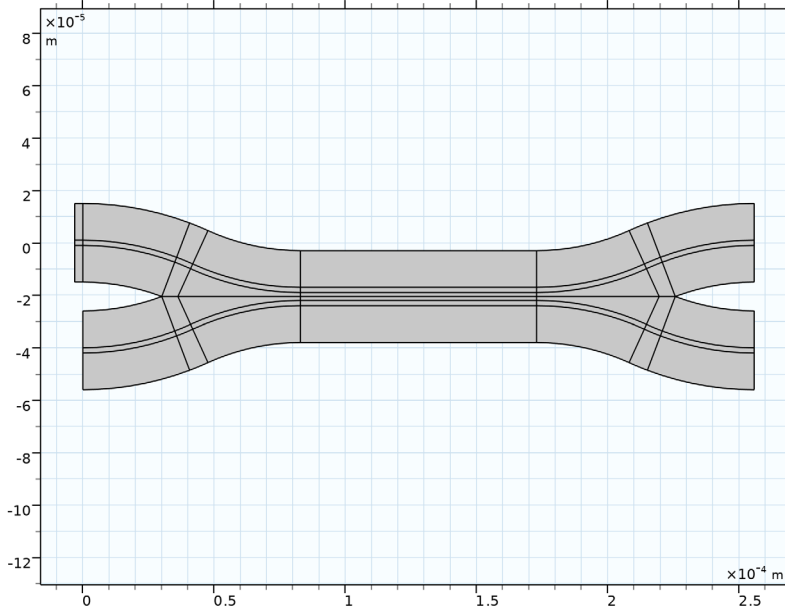

Again, assign selections from the part to the cumulative core, cladding, and transverse perimeter selections.



- 8 Locate the **Domain Selections** section. In the table, enter the following settings:

Name	Keep	Physics	Contribute to
Core		√	Core
Cladding		√	Cladding

- 9 Locate the **Boundary Selections** section. In the table, enter the following settings:

Name	Keep	Physics	Contribute to
Transverse perimeter		√	Transverse Perimeter

Slab Waveguide Straight 2 (pi3)

- 1 Right-click **Component 1 (comp1)** > **Geometry 1** > **Slab Waveguide Straight 1 (pi2)** and choose **Duplicate**.
- 2 In the **Settings** window for **Part Instance**, locate the **Position and Orientation of Output** section.
- 3 In the **y-displacement** text field, type `-d_pcc`.
- 4 Click  **Build All Objects**.
- 5 Click the  **Zoom Extents** button in the **Graphics** toolbar.

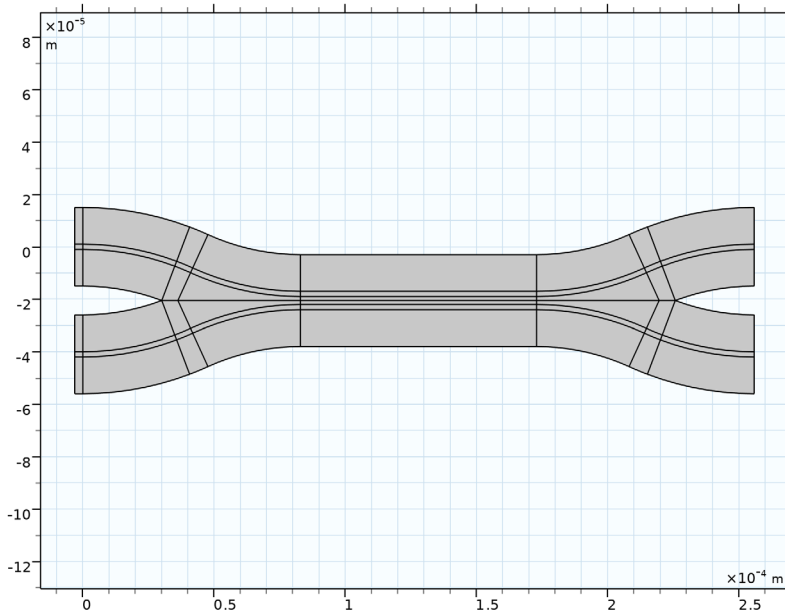

Slab Waveguide Straight 3 (pi4)

- 1 Right-click **Slab Waveguide Straight 1 (pi2)** and choose **Duplicate**.
- 2 In the **Settings** window for **Part Instance**, locate the **Input Parameters** section.
- 3 In the table, enter the following settings:

Name	Expression	Value	Description
element_length	d_mz	1E-4 m	Element length

- 4 Locate the **Position and Orientation of Output** section. In the **x-displacement** text field, type `d_dc`.
- 5 Click  **Build All Objects**.

6 Click the  **Zoom Extents** button in the **Graphics** toolbar.

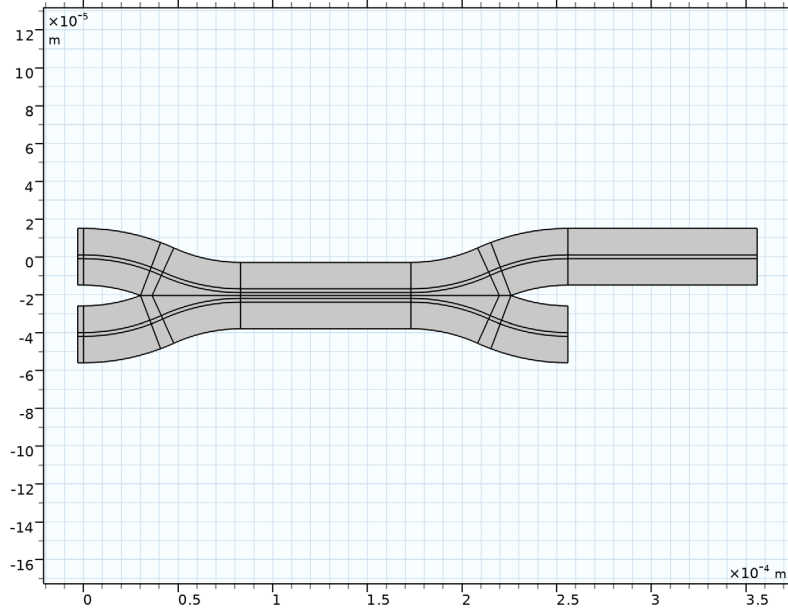

Slab Waveguide Straight 4 (pi5)

- 1 Right-click **Slab Waveguide Straight 3 (pi4)** and choose **Duplicate**.
- 2 In the **Settings** window for **Part Instance**, locate the **Position and Orientation of Output** section.
- 3 In the **y-displacement** text field, type `-d_pcc`.
- 4 Click  **Build All Objects**.

5 Click the  **Zoom Extents** button in the **Graphics** toolbar.

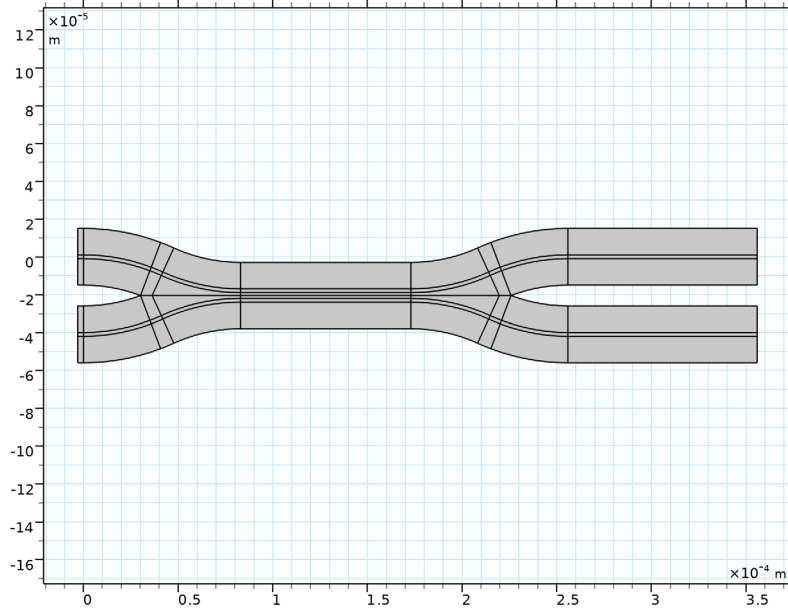

Slab Waveguide S-Bend Directional Coupler 2 (pi6)

- 1 In the **Model Builder** window, under **Component 1 (comp1)** > **Geometry 1** right-click **Slab Waveguide S-Bend Directional Coupler 1 (pi1)** and choose **Duplicate**.
- 2 In the **Settings** window for **Part Instance**, locate the **Position and Orientation of Output** section.
- 3 In the **x-displacement** text field, type $d_{dc}+d_{mz}$.
- 4 Click  **Build All Objects**.

- 5 Click the  **Zoom Extents** button in the **Graphics** toolbar.

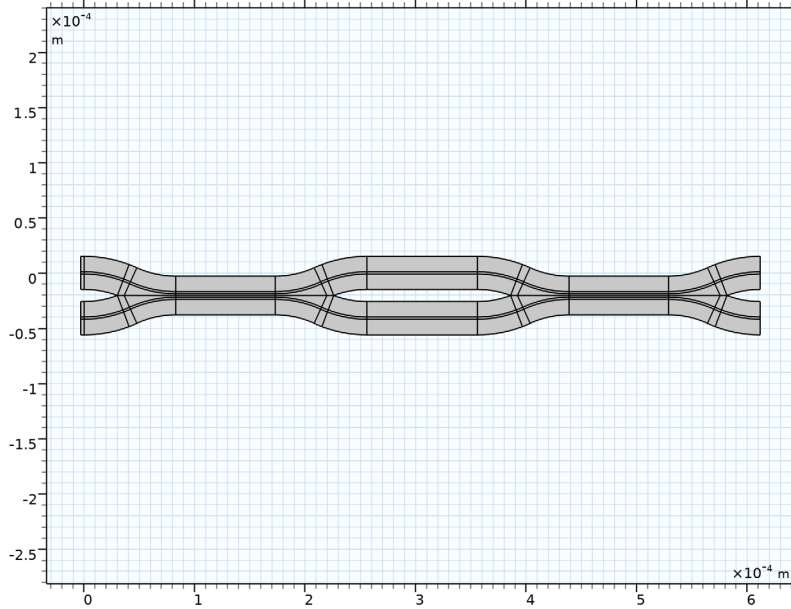

Slab Waveguide Straight 5 (pi7)

- 1 In the **Model Builder** window, under **Component 1 (comp1) > Geometry 1** right-click **Slab Waveguide Straight 1 (pi2)** and choose **Duplicate**.
- 2 In the **Settings** window for **Part Instance**, locate the **Position and Orientation of Output** section.
- 3 In the **x-displacement** text field, type $2*d_{dc}+d_{mz}$.
- 4 Click  **Build All Objects**.

5 Click the  **Zoom Extents** button in the **Graphics** toolbar.

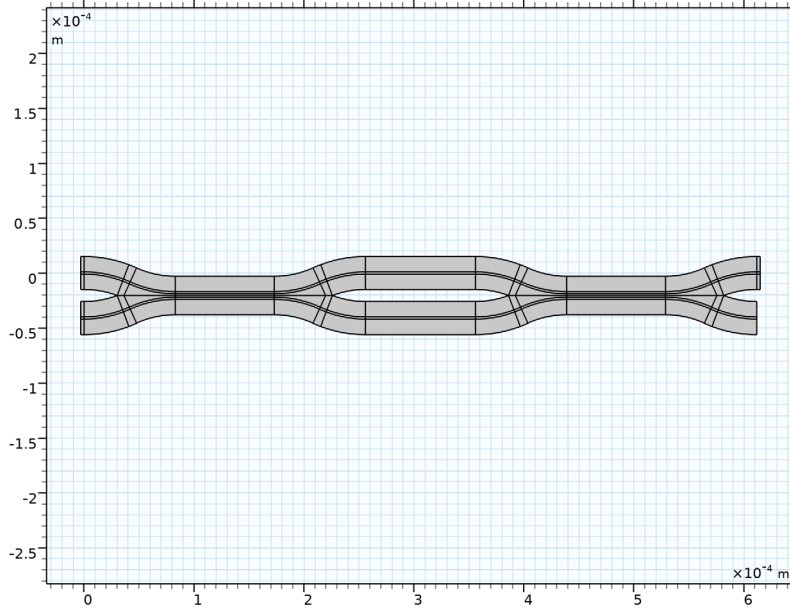

Slab Waveguide Straight 6 (pi8)

- 1 Right-click **Slab Waveguide Straight 5 (pi7)** and choose **Duplicate**.
- 2 In the **Settings** window for **Part Instance**, locate the **Position and Orientation of Output** section.
- 3 In the **y-displacement** text field, type `-d_pcc`.
- 4 Click  **Build All Objects**.

5 Click the  **Zoom Extents** button in the **Graphics** toolbar.

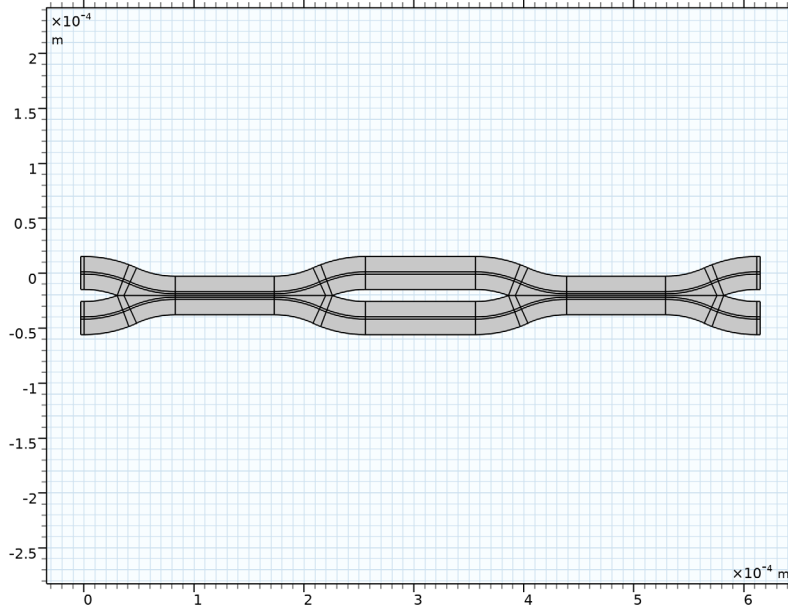

Slab Waveguide Straight 2 (pi3)

Now, add selections for the port boundaries.

- 1 In the **Model Builder** window, click **Slab Waveguide Straight 2 (pi3)**.
- 2 In the **Settings** window for **Part Instance**, locate the **Boundary Selections** section.
- 3 Click **New Cumulative Selection**.
- 4 In the **New Cumulative Selection** dialog, type Port 1 in the **Name** text field.
- 5 Click **OK**.
- 6 In the **Settings** window for **Part Instance**, locate the **Boundary Selections** section.
- 7 In the table, enter the following settings:

Name	Keep	Physics	Contribute to
Port 1		√	Port 1

Slab Waveguide Straight 5 (pi7)

- 1 In the **Model Builder** window, click **Slab Waveguide Straight 5 (pi7)**.
- 2 In the **Settings** window for **Part Instance**, locate the **Boundary Selections** section.
- 3 Click **New Cumulative Selection**.

- 4 In the **New Cumulative Selection** dialog, type Port 2 in the **Name** text field.
- 5 Click **OK**.
- 6 In the **Settings** window for **Part Instance**, locate the **Boundary Selections** section.
- 7 In the table, enter the following settings:

Name	Keep	Physics	Contribute to
Port 2		√	Port 2

Slab Waveguide Straight 1 (pi2)

- 1 In the **Model Builder** window, click **Slab Waveguide Straight 1 (pi2)**.
- 2 In the **Settings** window for **Part Instance**, locate the **Boundary Selections** section.
- 3 Click **New Cumulative Selection**.
- 4 In the **New Cumulative Selection** dialog, type Port 3 in the **Name** text field.
- 5 Click **OK**.
- 6 In the **Settings** window for **Part Instance**, locate the **Boundary Selections** section.
- 7 In the table, enter the following settings:

Name	Keep	Physics	Contribute to
Port 1		√	Port 3

Slab Waveguide Straight 6 (pi8)

- 1 In the **Model Builder** window, click **Slab Waveguide Straight 6 (pi8)**.
- 2 In the **Settings** window for **Part Instance**, locate the **Boundary Selections** section.
- 3 Click **New Cumulative Selection**.
- 4 In the **New Cumulative Selection** dialog, type Port 4 in the **Name** text field.
- 5 Click **OK**.
- 6 In the **Settings** window for **Part Instance**, locate the **Boundary Selections** section.
- 7 In the table, enter the following settings:

Name	Keep	Physics	Contribute to
Port 2		√	Port 4

Slab Waveguide Straight 3 (pi4)

Add two selections that later will be used by integration operators.

- 1 In the **Model Builder** window, click **Slab Waveguide Straight 3 (pi4)**.
- 2 In the **Settings** window for **Part Instance**, locate the **Boundary Selections** section.

- 3 Click **New Cumulative Selection**.
- 4 In the **New Cumulative Selection** dialog, type End of Upper Mach-Zehnder Waveguide in the **Name** text field.
- 5 Click **OK**.
- 6 In the **Settings** window for **Part Instance**, locate the **Boundary Selections** section.
- 7 In the table, enter the following settings:

Name	Keep	Physics	Contribute to
Port 2		√	End of Upper Mach-Zehnder Waveguide

Slab Waveguide Straight 4 (pi5)

- 1 In the **Model Builder** window, click **Slab Waveguide Straight 4 (pi5)**.
- 2 In the **Settings** window for **Part Instance**, locate the **Boundary Selections** section.
- 3 Click **New Cumulative Selection**.
- 4 In the **New Cumulative Selection** dialog, type End of Lower Mach-Zehnder Waveguide in the **Name** text field.
- 5 Click **OK**.
- 6 In the **Settings** window for **Part Instance**, locate the **Boundary Selections** section.
- 7 In the table, enter the following settings:

Name	Keep	Physics	Contribute to
Port 2		√	End of Lower Mach-Zehnder Waveguide

Edge Mesh

- 1 In the **Geometry** toolbar, click  **Selections** and choose **Union Selection**.
- 2 In the **Settings** window for **Union Selection**, type Edge Mesh in the **Label** text field. This selection will be used later when defining the selection for an edge mesh feature.
- 3 Locate the **Geometric Entity Level** section. From the **Level** list, choose **Boundary**.
- 4 Locate the **Input Entities** section. Click **+ Add**.
- 5 In the **Add** dialog, in the **Selections to add** list, choose **Port 1** and **Port 3**.
- 6 Click **OK**.

MATERIALS

Define the materials for the waveguide structure.

Cladding

- 1 In the **Model Builder** window, under **Component 1 (comp1)** right-click **Materials** and choose **Blank Material**.
- 2 In the **Settings** window for **Material**, type Cladding in the **Label** text field.
- 3 Locate the **Material Contents** section. In the table, enter the following settings:

Property	Variable	Value	Unit	Property group
Refractive index, real part	n_{iso} ; $n_{ii} = n_{iso}$, $n_{ij} = 0$	n_{clad}	1	Refractive index

Core

- 1 Right-click **Materials** and choose **Blank Material**.
- 2 In the **Settings** window for **Material**, type Core in the **Label** text field.
- 3 Locate the **Geometric Entity Selection** section. From the **Selection** list, choose **Core**.
- 4 Locate the **Material Contents** section. In the table, enter the following settings:

Property	Variable	Value	Unit	Property group
Refractive index, real part	n_{iso} ; $n_{ii} = n_{iso}$, $n_{ij} = 0$	n_{core}	1	Refractive index

ELECTROMAGNETIC WAVES, BEAM ENVELOPES (EWBE)

Set up the interface for unidirectional propagation, using the wave number calculated in the boundary mode analysis.

- 1 In the **Model Builder** window, under **Component 1 (comp1)** click **Electromagnetic Waves, Beam Envelopes (ewbe)**.
- 2 In the **Settings** window for **Electromagnetic Waves, Beam Envelopes**, locate the **Components** section.
- 3 From the **Electric field components solved for** list, choose **Out-of-plane vector**.
- 4 Locate the **Wave Vectors** section. From the **Number of directions** list, choose **Unidirectional**.
- 5 Specify the \mathbf{k}_1 vector as

$ewbe.beta_1$	x
0	y

Port 1

Now define the input and the output ports, using the previously defined selections.

- 1 In the **Physics** toolbar, click  **Boundaries** and choose **Port**.
- 2 In the **Settings** window for **Port**, locate the **Boundary Selection** section.
- 3 From the **Selection** list, choose **Port 1**.
- 4 Locate the **Port Properties** section. From the **Type of port** list, choose **Numeric**.
For the first port, wave excitation is **On** by default.

Port 2

- 1 In the **Physics** toolbar, click  **Boundaries** and choose **Port**.
- 2 In the **Settings** window for **Port**, locate the **Boundary Selection** section.
- 3 From the **Selection** list, choose **Port 2**.
- 4 Locate the **Port Properties** section. From the **Type of port** list, choose **Numeric**.

Port 3

- 1 In the **Physics** toolbar, click  **Boundaries** and choose **Port**.
- 2 In the **Settings** window for **Port**, locate the **Boundary Selection** section.
- 3 From the **Selection** list, choose **Port 3**.
- 4 Locate the **Port Properties** section. From the **Type of port** list, choose **Numeric**.

Port 4

- 1 In the **Physics** toolbar, click  **Boundaries** and choose **Port**.
- 2 In the **Settings** window for **Port**, locate the **Boundary Selection** section.
- 3 From the **Selection** list, choose **Port 4**.
- 4 Locate the **Port Properties** section. From the **Type of port** list, choose **Numeric**.

Scattering Boundary Condition 1

Use the scattering boundary condition to absorb some of the light that is not guided by the waveguide. The scattering boundary condition is only absorbing light propagating close to the normal direction to the boundary, so it will not absorb unguided light propagating with large angles of incidence.

- 1 In the **Physics** toolbar, click  **Boundaries** and choose **Scattering Boundary Condition**.
- 2 In the **Settings** window for **Scattering Boundary Condition**, locate the **Boundary Selection** section.
- 3 From the **Selection** list, choose **Transverse Perimeter**.

MESH 1

Define a mesh on the edge and then map it over the whole domain.

- 1 In the **Model Builder** window, under **Component 1 (comp1)** click **Mesh 1**.
- 2 In the **Settings** window for **Mesh**, locate the **Physics-Controlled Mesh** section.
- 3 In the table, clear the **Use** checkbox for **Electromagnetic Waves, Beam Envelopes (ewbe)**.
- 4 Locate the **Sequence Type** section. From the list, choose **User-controlled mesh**.

Free Triangular 1

In the **Model Builder** window, under **Component 1 (comp1) > Mesh 1** right-click **Free Triangular 1** and choose **Delete**. Click **Yes** to confirm.

Edge 1

- 1 In the **Mesh** toolbar, click  **More Generators** and choose **Edge**.
- 2 In the **Settings** window for **Edge**, locate the **Boundary Selection** section.
- 3 From the **Selection** list, choose **Edge Mesh**.

Size 1

- 1 Right-click **Edge 1** and choose **Size**.
- 2 In the **Settings** window for **Size**, locate the **Element Size** section.
- 3 Click the **Custom** button.
- 4 Locate the **Element Size Parameters** section.
- 5 Select the **Maximum element size** checkbox. In the associated text field, type hy .

Size 2

- 1 In the **Model Builder** window, right-click **Edge 1** and choose **Size**.
- 2 In the **Settings** window for **Size**, locate the **Geometric Entity Selection** section.
- 3 Click  **Clear Selection**.
- 4 Select Boundaries 3 and 10 only. Those correspond to port boundaries adjacent to the cores of the waveguides.
- 5 Locate the **Element Size** section. Click the **Custom** button.
- 6 Locate the **Element Size Parameters** section.
- 7 Select the **Maximum element size** checkbox. In the associated text field, type $\min(hy, w/4)$.

Mapped 1

- 1 In the **Mesh** toolbar, click  **Mapped**.
- 2 In the **Settings** window for **Mapped**, click to expand the **Reduce Element Skewness** section.
- 3 Select the **Adjust edge mesh** checkbox.

Size 1

- 1 Right-click **Mapped 1** and choose **Size**.
- 2 In the **Settings** window for **Size**, locate the **Element Size** section.
- 3 Click the **Custom** button.
- 4 Locate the **Element Size Parameters** section.
- 5 Select the **Maximum element size** checkbox. In the associated text field, type hx .
- 6 Click  **Build All**.

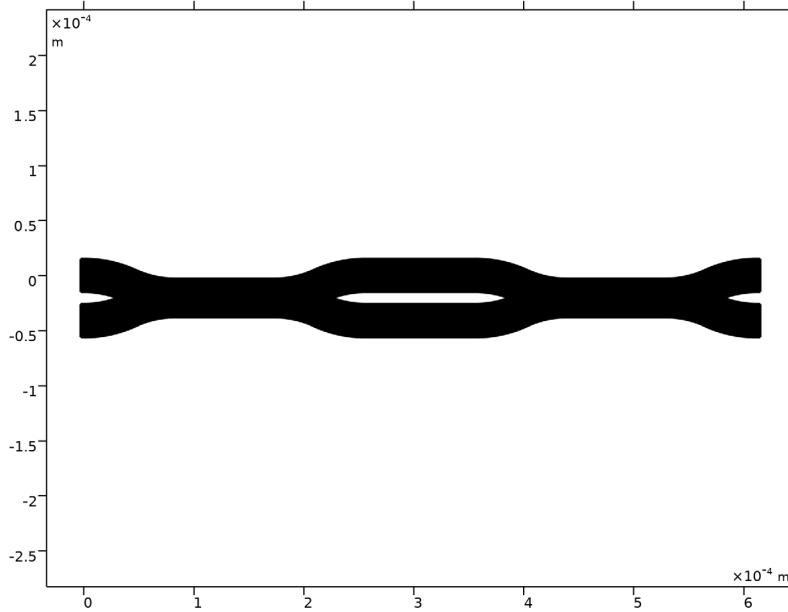

STUDY 1

Step 1: Boundary Mode Analysis

Now define the boundary mode analysis study steps for the numeric ports and the frequency domain study for finding the domain solution.

- 1 In the **Model Builder** window, under **Study 1** click **Step 1: Boundary Mode Analysis**.
- 2 In the **Settings** window for **Boundary Mode Analysis**, locate the **Study Settings** section.
- 3 In the **Mode analysis frequency** text field, type $f0$.
- 4 Select the **Search for modes around shift** checkbox. In the associated text field, type n_{core} .

Step 3: Boundary Mode Analysis 1

- 1 Right-click **Study 1** > **Step 1: Boundary Mode Analysis** and choose **Duplicate**.
- 2 In the **Settings** window for **Boundary Mode Analysis**, locate the **Study Settings** section.
- 3 In the **Port name** text field, type 2.

Step 4: Boundary Mode Analysis 2

- 1 Right-click **Step 3: Boundary Mode Analysis 1** and choose **Duplicate**.
- 2 In the **Settings** window for **Boundary Mode Analysis**, locate the **Study Settings** section.
- 3 In the **Port name** text field, type 3.

Step 5: Boundary Mode Analysis 3

- 1 Right-click **Step 4: Boundary Mode Analysis 2** and choose **Duplicate**.
- 2 In the **Settings** window for **Boundary Mode Analysis**, locate the **Study Settings** section.
- 3 In the **Port name** text field, type 4.

Step 2: Frequency Domain

- 1 In the **Model Builder** window, click **Step 2: Frequency Domain**.
- 2 In the **Settings** window for **Frequency Domain**, locate the **Study Settings** section.
- 3 In the **Frequencies** text field, type f0.
- 4 Right-click **Study 1** > **Step 2: Frequency Domain** and choose **Move Down** three times, or simply drag and drop the frequency domain study step to the last position.
- 5 In the **Study** toolbar, click  **Compute**.

RESULTS

Plots of the mode fields are automatically generated, when numeric ports are used. Inspect the mode field for the first port.

Electric Mode Field, Port 1 (ewbe)

In the **Model Builder** window, under **Results** click **Electric Mode Field, Port 1 (ewbe)**.

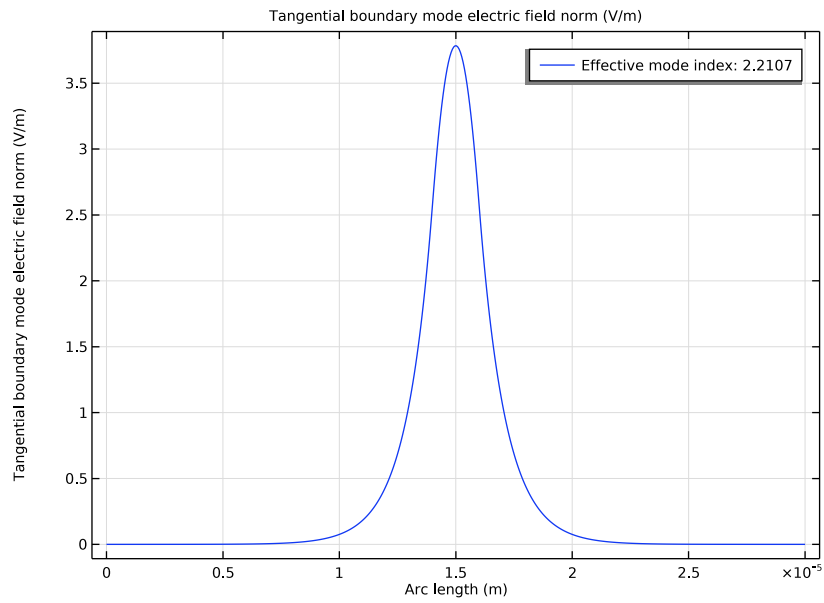

Electric Field (ewbe)

I In the **Model Builder** window, click **Electric Field (ewbe)**.

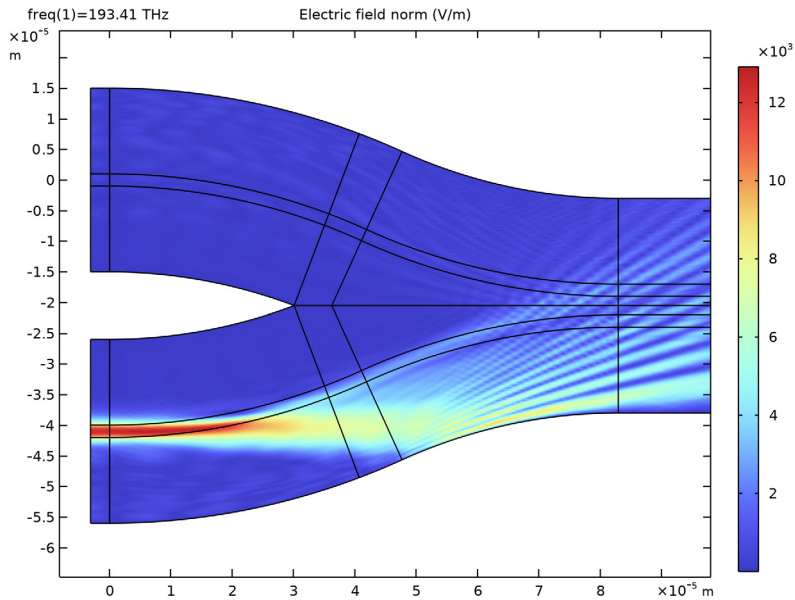

2 Zoom in on a part of the waveguide bend.



As seen from the result graph, the wave is not bound to the core when the bend radius is so small. To make the wave follow the waveguide core, the bend radius must be increased. Thus, make a parametric sweep of the bend radius to find the smallest radius that gives a sufficient transmission.

STUDY 1

Parametric Sweep

- 1 In the **Study** toolbar, click  **Parametric Sweep**.
- 2 In the **Settings** window for **Parametric Sweep**, locate the **Study Settings** section.
- 3 Click **+ Add**.
- 4 From the list in the **Parameter name** column, choose **r0 (Bend radius)**.
- 5 Click  **Range**.
- 6 In the **Range** dialog, type 0.1 [mm] in the **Start** text field.
- 7 In the **Step** text field, type 0.4 [mm].
- 8 In the **Stop** text field, type 2.5 [mm].
- 9 Click **Replace**.
- 10 In the **Settings** window for **Parametric Sweep**, locate the **Study Settings** section.

11 In the table, enter the following settings:

Parameter name	Parameter value list	Parameter unit
r0 (Bend radius)	range(0.1[mm],0.4[mm],2.5[mm])	mm

12 In the **Study** toolbar, click  **Compute**.

RESULTS

Reflectance, Transmittance, and Loss (ewbe)

Replace the absorptance variable with a variable that calculates the outcoupling loss through the **Scattering Boundary Condition 1** boundaries, and change the y-axis label and the plot legend accordingly.

- 1 In the **Model Builder** window, under **Results** click **Reflectance, Transmittance, and Absorptance (ewbe)**.
- 2 In the **Settings** window for **ID Plot Group**, type Reflectance, Transmittance, and Loss (ewbe) in the **Label** text field.
- 3 Locate the **Plot Settings** section. In the **y-axis label** text field, type Reflectance, transmittance, and loss (1).

Global 1

- 1 In the **Model Builder** window, expand the **Reflectance, Transmittance, and Loss (ewbe)** node, then click **Global 1**.
- 2 In the **Settings** window for **Global**, locate the **y-Axis Data** section.
- 3 In the table, enter the following settings:

Expression	Unit	Description
ewbe.sctr1.etaOut	1	Loss

Add markers and use different line types, to make it easier to distinguish the different curves.

- 4 Click to expand the **Coloring and Style** section. Find the **Line style** subsection. From the **Line** list, choose **Cycle**.
- 5 Find the **Line markers** subsection. From the **Marker** list, choose **Cycle**.

Reflectance, Transmittance, and Loss (ewbe)

- 1 In the **Model Builder** window, click **Reflectance, Transmittance, and Loss (ewbe)**.
- 2 In the **Settings** window for **ID Plot Group**, locate the **Legend** section.

- 3 From the **Position** list, choose **Middle left**. Your graph should look the same as the graph in [Figure 2](#). A loss of approximately 5% seems reasonable, which you get for a bend radius of 2.5 mm.

Electric Field (ewbe) 1

- 1 In the **Model Builder** window, click **Electric Field (ewbe) 1**.
- 2 Zoom in on a part of the waveguide bend.
- 3 In the **Electric Field (ewbe) 1** toolbar, click  **Plot**. Compare your graph to [Figure 3](#). As you see, for a 2.5 mm bend radius, the wave is bound to the waveguide core. Thus, now set the bend radius parameter to 2.5 mm.

GLOBAL DEFINITIONS

Geometry Parameters



- 1 In the **Model Builder** window, under **Global Definitions** click **Geometry Parameters**.
- 2 In the **Settings** window for **Parameters**, locate the **Parameters** section.
- 3 In the table, enter the following settings:

Name	Expression	Value	Description
r0	2.5[mm]	0.0025 m	Bend radius

DEFINITIONS

Now make sure that the directional coupler splits power of the incoming wave equally much into its output ports. To do this, compare the power in the two waveguide arms of the Mach–Zehnder interferometer.

Integration 1 (intop1)

- 1 In the **Definitions** toolbar, click  **Nonlocal Couplings** and choose **Integration**.
- 2 In the **Settings** window for **Integration**, locate the **Source Selection** section.
- 3 From the **Geometric entity level** list, choose **Boundary**.
- 4 From the **Selection** list, choose **End of Upper Mach-Zehnder Waveguide**.
- 5 Click  **Zoom to Selection**.

Integration 2 (intop2)

- 1 Right-click **Integration 1 (intop1)** and choose **Duplicate**.
- 2 In the **Settings** window for **Integration**, locate the **Source Selection** section.
- 3 From the **Selection** list, choose **End of Lower Mach-Zehnder Waveguide**.
- 4 Click  **Zoom to Selection**.

Variables I



- 1 In the **Definitions** toolbar, click  **Local Variables**.
- 2 In the **Settings** window for **Variables**, locate the **Variables** section.
- 3 In the table, enter the following settings:

Name	Expression	Unit	Description
P1	intop1(ewbe.nPoav)	W/m	Power in upper waveguide
P2	intop2(ewbe.nPoav)	W/m	Power in lower waveguide

STUDY I

Parametric Sweep

Modify the parametric sweep for a sweep of the directional coupler length.

- 1 In the **Model Builder** window, under **Study I** click **Parametric Sweep**.
- 2 In the **Settings** window for **Parametric Sweep**, locate the **Study Settings** section.
- 3 From the list in the **Parameter name** column, choose **d_cpl (Length of straight directional coupler waveguides)**.
- 4 Click  **Range**.
- 5 In the **Range** dialog, type 80[um] in the **Start** text field.
- 6 In the **Step** text field, type 50[um].
- 7 In the **Stop** text field, type 430[um].
- 8 Click **Replace**.
- 9 In the **Study** toolbar, click  **Compute**.

RESULTS

First, inspect the results for the transmittances and the loss.

Global I

- 1 In the **Model Builder** window, under **Results > Reflectance, Transmittance, and Loss (ewbe)** click **Global I**.
- 2 In the **Settings** window for **Global**, locate the **x-Axis Data** section.
- 3 In the **Expression** text field, type d_cp1.
- 4 From the **Unit** list, choose **µm**.

Reflectance, Transmittance, and Loss (ewbe)

- 1 In the **Model Builder** window, click **Reflectance, Transmittance, and Loss (ewbe)**.

- 2 In the **Settings** window for **ID Plot Group**, locate the **Legend** section.
- 3 From the **Position** list, choose **Middle right**.
- 4 In the **Reflectance, Transmittance, and Loss (ewbe)** toolbar, click  **Plot**.

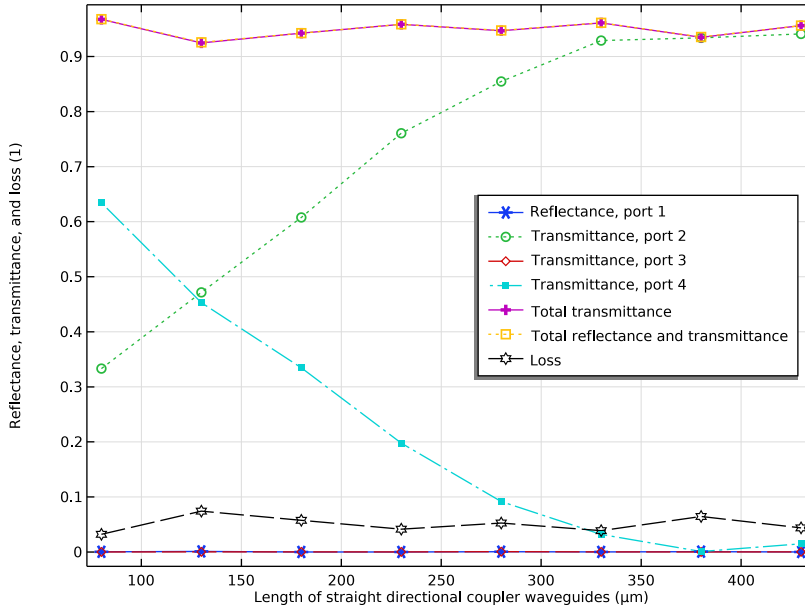

As this plot does not answer the question whether the powers in the upper and lower waveguides are equal, create a new ID plot.

Power Difference

- 1 In the **Results** toolbar, click  **ID Plot Group**.
- 2 In the **Settings** window for **ID Plot Group**, type Power Difference in the **Label** text field.
- 3 Locate the **Data** section. From the **Dataset** list, choose **Study 1/ Parametric Solutions 1 (sol6)**.

Global 1

- 1 Right-click **Power Difference** and choose **Global**.
- 2 In the **Settings** window for **Global**, locate the **y-Axis Data** section.
- 3 In the table, enter the following settings:



Expression	Unit	Description
abs(P2-P1)	W/m	Power difference

- 4 Locate the **x-Axis Data** section. From the **Axis source data** list, choose **Outer solutions**.
- 5 From the **Parameter** list, choose **Expression**.
- 6 In the **Expression** text field, type `d_cp1`.
- 7 From the **Unit** list, choose **μm**.

Power Difference

- 1 In the **Model Builder** window, click **Power Difference**.
- 2 In the **Settings** window for **ID Plot Group**, locate the **Legend** section.
- 3 Clear the **Show legends** checkbox.
- 4 In the **Power Difference** toolbar, click  **Plot**. Your graph should now look like [Figure 4](#).

Electric Field (ewbe) I

- 1 In the **Model Builder** window, click **Electric Field (ewbe) I**.
- 2 In the **Electric Field (ewbe) I** toolbar, click  **Plot**.
- 3 Click the  **Zoom Extents** button in the **Graphics** toolbar.
- 4 Click the  **Zoom In** button in the **Graphics** toolbar four times. Your plot should now look like [Figure 5](#).

GLOBAL DEFINITIONS

As shown in [Figure 4](#) and [Figure 5](#), the power in the two waveguides is almost the same when the directional coupler waveguides are 380 μm long. Thus, set the parameter `d_cp1` to 380 μm.

Geometry Parameters

- 1 In the **Model Builder** window, under **Global Definitions** click **Geometry Parameters**.
- 2 In the **Settings** window for **Parameters**, locate the **Parameters** section.
- 3 In the table, enter the following settings:

Name	Expression	Value	Description
<code>d_cp1</code>	<code>380[um]</code>	<code>3.8E-4 m</code>	Length of directional coupler waveguides

The final geometry parameter to fix is the Mach-Zehnder waveguide length. Set it to 2 cm.



4 In the table, enter the following settings:

Name	Expression	Value	Description
d_mz	2[cm]	0.02 m	Length of Mach-Zehnder waveguides

COMPONENT 1 (COMP1)

Finally, add an Electrostatics user interface to apply an electric field across the waveguide in one of the arms of the interferometer.

ADD PHYSICS

- 1 In the **Home** toolbar, click  **Add Physics** to open the **Add Physics** window.
- 2 Go to the **Add Physics** window.
- 3 In the tree, select **AC/DC** > **Electric Fields and Currents** > **Electrostatics (es)**.
- 4 Click the **Add to Component 1** button in the window toolbar.
- 5 In the **Home** toolbar, click  **Add Physics** to close the **Add Physics** window.

GEOMETRY 1

Add two lines for the terminals - one for the ground and one for the applied voltage.

Polygon 1 (pol1)

- 1 In the **Geometry** toolbar, click  **Polygon**.
- 2 In the **Settings** window for **Polygon**, locate the **Coordinates** section.
- 3 In the table, enter the following settings:

x (m)	y (m)
d_dc	-w
d_dc+d_mz	-w

Polygon 2 (pol2)

- 1 Right-click **Polygon 1 (pol1)** and choose **Duplicate**.
- 2 In the **Settings** window for **Polygon**, locate the **Coordinates** section.
- 3 In the table, enter the following settings:

x (m)	y (m)
d_dc	w
d_dc+d_mz	w

- 4 Click  **Build All Objects**.

5 Zoom in on one end of the polygon.

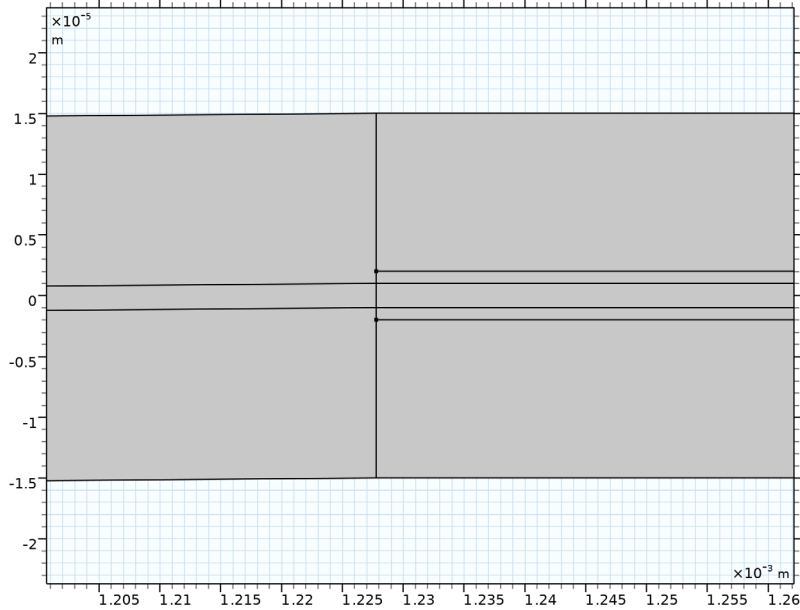

ELECTROSTATICS (ES)

Now, add a voltage terminal and a ground.

Charge Conservation in Solids I

- 1 In the **Physics** toolbar, click  **Domains** and choose **Charge Conservation in Solids**.
- 2 In the **Settings** window for **Charge Conservation in Solids**, locate the **Domain Selection** section.
- 3 From the **Selection** list, choose **All domains**.

Electric Potential I

- 1 In the **Physics** toolbar, click  **Boundaries** and choose **Electric Potential**.

2 Select Boundary 84 only.

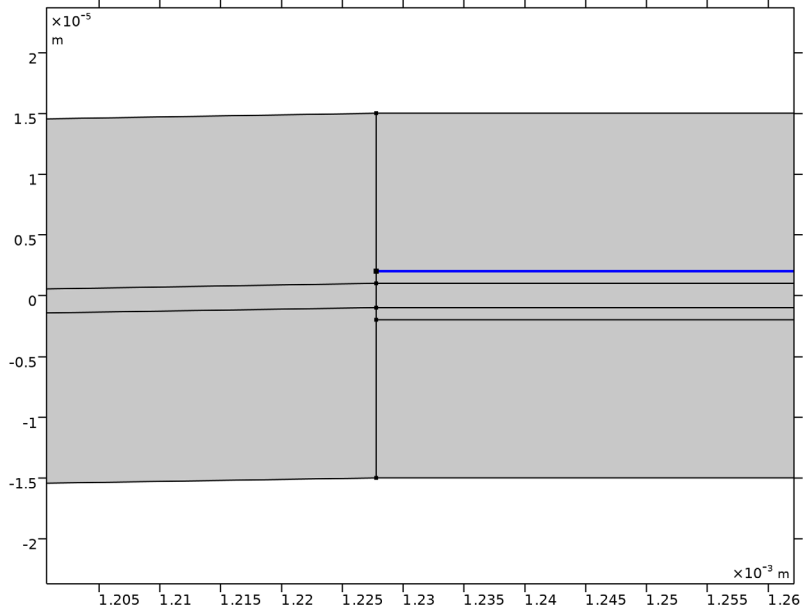

3 In the **Settings** window for **Electric Potential**, locate the **Electric Potential** section.

4 In the V_0 text field, type V_0 .

Ground 1

1 In the **Physics** toolbar, click  **Boundaries** and choose **Ground**.

2 Select Boundary 78 only.

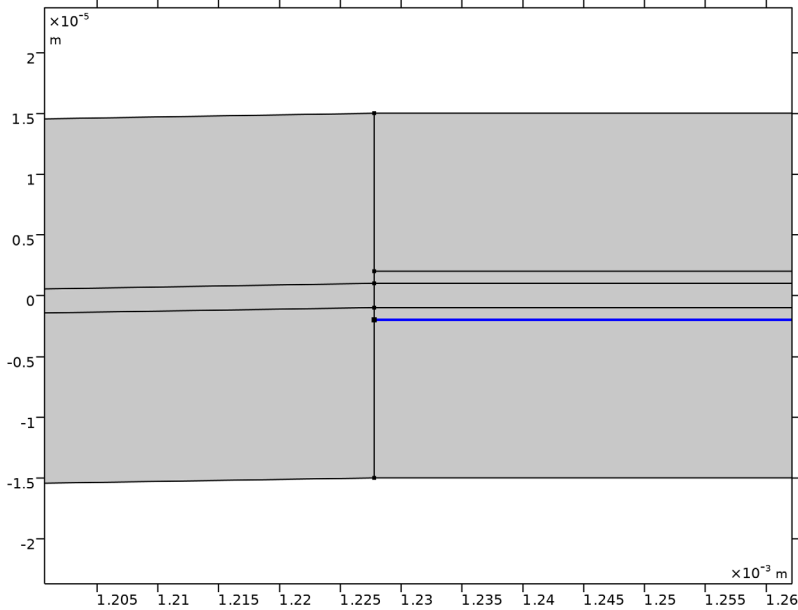

MATERIALS

Cladding (mat1)

- 1 In the **Model Builder** window, under **Component 1 (comp1) > Materials** click **Cladding (mat1)**.
- 2 In the **Settings** window for **Material**, locate the **Material Contents** section.
- 3 Click to select row number 3 in the table.
- 4 Click  **Break Synchronization**.
- 5 Click to select row number 1 in the table.
- 6 Right-click the **Relative permittivity** row and choose **Edit**.
- 7 In the **Relative permittivity** dialog, choose **Isotropic** from the list.
- 8 In the text field, type `epsr`.
- 9 Click **OK**.

Core (mat2)

- 1 In the **Model Builder** window, click **Core (mat2)**.
- 2 In the **Settings** window for **Material**, locate the **Material Contents** section.

- 3 Click to select row number 3 in the table.
- 4 Click  **Break Synchronization**.
- 5 Click to select row number 1 in the table.
- 6 Right-click the **Relative permittivity** row and choose **Edit**.
- 7 In the **Relative permittivity** dialog, choose **Isotropic** from the list.
- 8 In the text field, type ϵ_{psr} .
- 9 Click **OK**.

Cladding (mat1)

Also make sure that the refractive index is changed by the applied static electric field.

- 1 In the **Model Builder** window, click **Cladding (mat1)**.
- 2 In the **Settings** window for **Material**, locate the **Material Contents** section.
- 3 In the table, enter the following settings:

Property	Variable	Value	Unit	Property group
Refractive index, real part	$n_{iso}; n_{ij} = 0$	$n_{clad} - 0.5 * n_{clad}^3 * r_{13} * \epsilon_s \cdot E_y$	1	Refractive index

Core (mat2)

- 1 In the **Model Builder** window, click **Core (mat2)**.
- 2 In the **Settings** window for **Material**, locate the **Material Contents** section.
- 3 In the table, enter the following settings:

Property	Variable	Value	Unit	Property group
Refractive index, real part	$n_{iso}; n_{ij} = 0$	$n_{core} - 0.5 * n_{core}^3 * r_{13} * \epsilon_s \cdot E_y$	1	Refractive index

STUDY 1

Parametric Sweep

- 1 In the **Model Builder** window, under **Study 1** click **Parametric Sweep**.
- 2 In the **Settings** window for **Parametric Sweep**, locate the **Study Settings** section.
- 3 From the list in the **Parameter name** column, choose **V0 (Applied voltage)**.
- 4 Click  **Range**.
- 5 In the **Range** dialog, type 0[V] in the **Start** text field.

- 6 In the **Step** text field, type 0.1 [V].
- 7 In the **Stop** text field, type 1 [V].
- 8 Click **Replace**.

Step 6: Stationary

- 1 In the **Study** toolbar, click  **Stationary**.
- 2 Right-click **Study 1** > **Step 6: Stationary** and choose **Move Up**.

Step 6: Frequency Domain

- 1 In the **Model Builder** window, click **Step 6: Frequency Domain**.
- 2 In the **Settings** window for **Frequency Domain**, locate the **Physics and Variables Selection** section.
- 3 In the **Solve for** column of the table, under **Component 1 (comp1)**, clear the checkbox for **Electrostatics (es)**.
- 4 In the **Study** toolbar, click  **Compute**.

RESULTS

Global 1

- 1 In the **Model Builder** window, under **Results** > **Reflectance, Transmittance, and Loss (ewbe)** click **Global 1**.
- 2 In the **Settings** window for **Global**, locate the **x-Axis Data** section.
- 3 In the **Expression** text field, type $V0$.
- 4 In the **Reflectance, Transmittance, and Loss (ewbe)** toolbar, click  **Plot**. Compare your graph with [Figure 6](#).