



Model created in COMSOL Multiphysics 6.4

# Hexagonal Grating

## Introduction

---

A hexagonal grating is an infinite structure that is periodic with hexagonal (or rhomboid unit) cells. [Figure 1](#) shows the hexagonal domain used for this model. The reflecting perfectly conducting surface consists of regularly spaced protruding hemispheres.

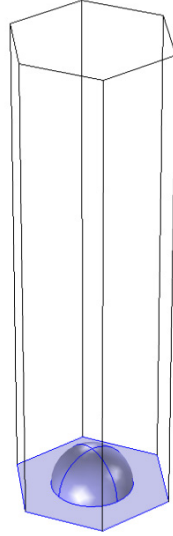

*Figure 1: The hexagonal domain, used for computing the diffraction from the hexagonal grating.*

As shown in [Figure 2](#), for a hexagonal cell of side length  $a$ , the corresponding unit cell is a rhomboid with side length  $\sqrt{3}a$ . In [Figure 2](#), the side vectors for the hexagonal cell starts from the point  $P$  and are denoted  $\mathbf{a}_1$  and  $\mathbf{a}_2$ . The angle between  $\mathbf{a}_1$  and  $\mathbf{a}_2$  is 120 degrees. Similarly, for the rhomboid unit cell, the primitive vectors are denoted  $\mathbf{u}_1$

and  $\mathbf{u}_2$  and starts from the hexagon center point  $Q$ . The angle between the two primitive vectors is also 120 degrees.

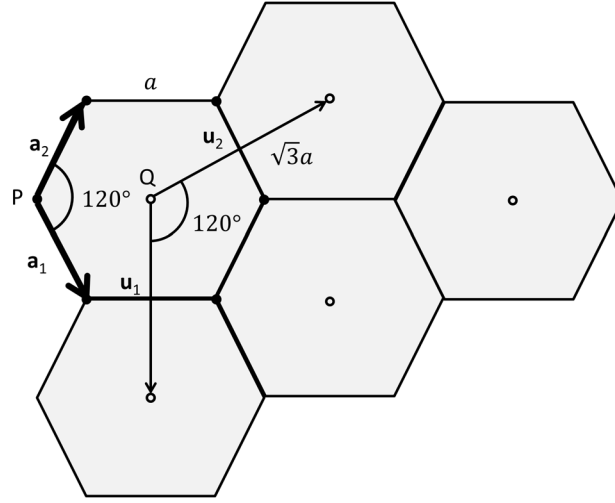

Figure 2: Schematic showing the hexagonal cells with side length  $a$  and side vectors  $\mathbf{a}_1$  and  $\mathbf{a}_2$ . The primitive cells are defined by the primitive vectors  $\mathbf{u}_1$  and  $\mathbf{u}_2$ .

If the incident plane wave have a wave vector defined by

$$\mathbf{k} = \mathbf{k}_{||} + \mathbf{k}_{\perp}, \quad (1)$$

where  $\mathbf{k}_{||}$  is the wave vector component parallel to the periodic boundary and  $\mathbf{k}_{\perp}$  is the component orthogonal to the periodic boundary, the in-plane wave vector component for diffraction order  $mn$  is given by

$$\mathbf{k}_{||mn} = \mathbf{k}_{||} + m\mathbf{G}_1 + n\mathbf{G}_2, \quad (2)$$

where the reciprocal lattice vectors  $\mathbf{G}_1$  and  $\mathbf{G}_2$  are defined from the primitive vectors  $\mathbf{u}_1$  and  $\mathbf{u}_2$  as

$$\mathbf{G}_1 = 2\pi \frac{\mathbf{u}_2 \times \mathbf{n}}{\mathbf{u}_1 \cdot (\mathbf{u}_2 \times \mathbf{n})} \quad (3)$$

and

$$\mathbf{G}_2 = 2\pi \frac{\mathbf{n} \times \mathbf{u}_1}{\mathbf{u}_2 \cdot (\mathbf{n} \times \mathbf{u}_1)}, \quad (4)$$

where  $\mathbf{n}$  is the normal vector (length 1) to the periodic boundary.

Since the out-of-plane wave vector component for mode  $mn$  is defined by

$$k_{\perp mn} = \sqrt{k^2 - k_{\parallel mn}^2}, \quad (5)$$

it is clear that for propagating modes, where the out-of-plane wave vector component above must be real, the length of the in-plane wave vector component must be smaller than the material wave number  $k$ . Figure 3 shows that it is only the modes inside the circle with radius  $k$  that will be propagating. In the example shown in Figure 3, there are five modes that will be propagating, in this case the modes  $m = n = 0$  (the reflected wave),  $m = -1, n = 0$ ,  $m = 0, n = -1$ ,  $m = -1, n = -1$ , and  $m = -2, n = -1$ . All other modes will be evanescent and damped out.

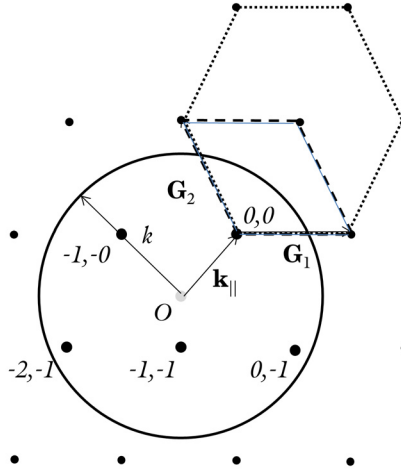

Figure 3: The reciprocal lattice, showing the reciprocal lattice vectors  $\mathbf{G}_1$  and  $\mathbf{G}_2$ , the in-plane wave vector component  $\mathbf{k}_{\parallel}$ , and the circle with radius  $k$  (the material wave number) enclosing the propagating mode points (larger dots). The dotted hexagon indicates that also the reciprocal lattice is a hexagonal point lattice. The dashed rhomboid indicates the unit cell spanned by the reciprocal lattice vectors.

## *Model Definition*

---

In this model, the unit cell is small compared to the wavelength, so there will only be two modes that are propagating, the modes  $m = 0, n = -1$  and  $m = -1, n = -1$ . For wavelengths longer than approximately  $1.01 \mu\text{m}$  (the critical wavelength), the mode  $m = 0, n = -1$  will be evanescent.

First a wavelength sweep will be made for an incident field having the polarization perpendicular to the plane of incidence (spanned by the wave vector for the incident wave and the normal to the periodic boundary) (so called s-polarization). Thereafter another wavelength sweep is made, but now with the polarization in the plane of incidence (p-polarization).

## *Results and Discussion*

---

Figure 4 shows the electric field norm and the propagation directions for the incident, the reflected and the diffracted waves. Notice that the diffracted waves come in pairs (both have the same mode numbers), one wave having the polarization in the plane-of-diffraction and the other wave have orthogonal polarization to the plane-of-diffraction. The plane-of-diffraction is spanned by the wave vector for the diffracted wave and the normal to the periodic boundary. The wavelength is close the critical wavelength for the

$m = 0, n = -1$  mode. This is evident from the plot, as the wave vector for that mode (the yellow arrows) is almost parallel to the periodic boundary.

lambda0(12)=1.01 μm Multislice: Electric field norm (V/m) Arrow Surface: Incident wave (red) Arrow Surface: Reflected wave (blue) Arrow Surface: Mode  $m = -1, n = -1$  (green) Arrow Surface: Mode  $m = 0, n = -1$  (yellow)

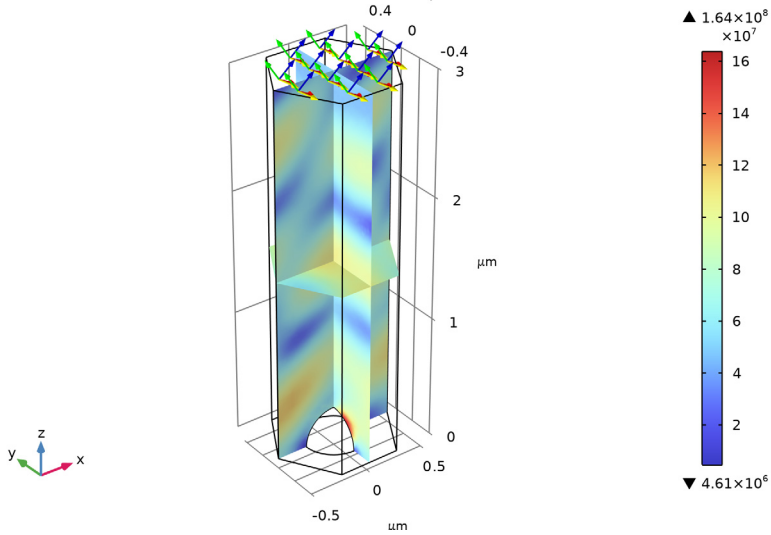

Figure 4: The electric field norm and the propagation directions for the incident wave (red arrows), the reflected wave (blue arrows) and the two diffraction orders (green and yellow arrows). The wavelength is 1.01 μm, which is close to the critical wavelength for the mode  $m = 0, n = -1$ , and the polarization of the incident wave is perpendicular to the plane of incidence.

Figure 5 shows the reflectance (for mode  $m = n = 0$ ) and the diffraction efficiencies for the diffracted waves. Notice that both the reflectance and the diffraction efficiency for the in-

plane-polarized  $m = -1, n = -1$  mode show resonances (peaks or dips) close to the critical wavelength for the  $m = 0, n = -1$  modes.

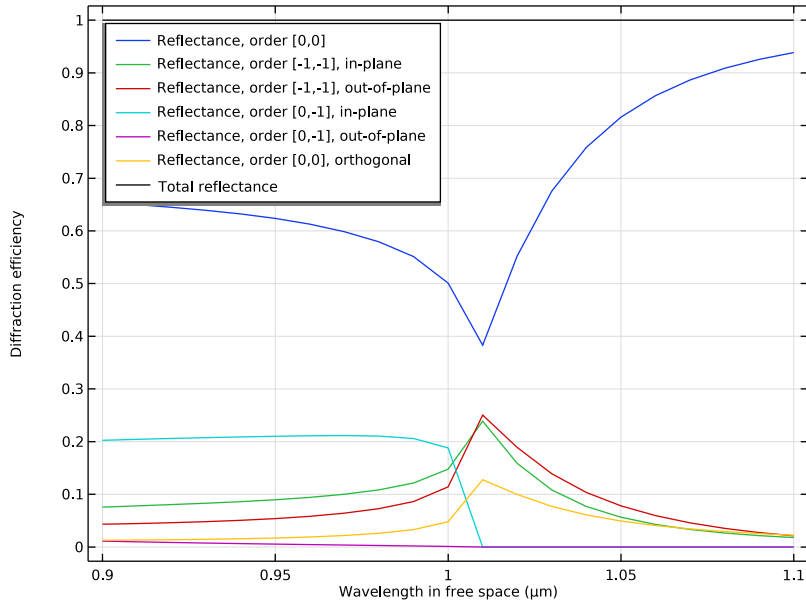

Figure 5: Diffraction efficiencies for the reflected wave and the diffracted waves. The polarization of the incident wave is perpendicular to the plane of incidence.

Figure 6 and Figure 7 show polarization plots for the same case as Figure 4 and Figure 5. It is clear that even though the polarization for the incident wave (the dotted horizontal line) is linear, the polarization for the reflected diffraction orders are elliptical. The size of the polarization ellipses indicates the diffraction efficiency. So, the zeroth diffraction order is the strongest and the  $m = -1, n = -1$  order is the weakest one. The blue solid line indicates the area in the  $m$ - $n$ -plane where there can be diffraction orders for propagating waves. As there does not exist any other mode numbers in this area, this is a verification

that the automatically added diffraction orders are the correct ones to include in the simulation.

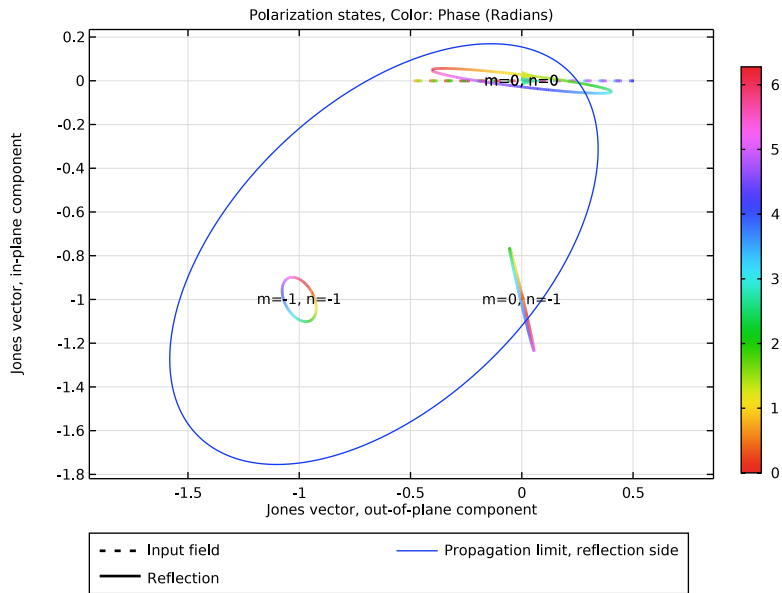

Figure 6: Polarization plot showing the polarization ellipses for the three diffraction orders that are not evanescent at the first wavelength,  $0.9 \mu\text{m}$ . The linearly polarized input field is indicated by the dotted line. The solid blue line encircles the area in which there can be diffraction orders representing propagating plane waves.

In Figure 7, at a slightly longer wavelength than in Figure 6, the  $m = 0, n = -1$  mode is evanescent. Thereby there is no polarization ellipse for that mode and the mode number (coordinate) appears outside of the solid blue line.

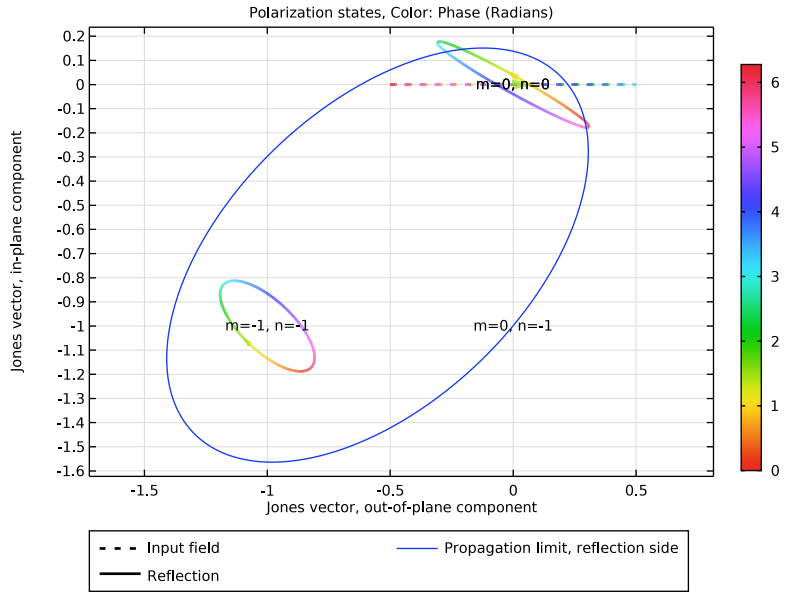

Figure 7: Polarization plot for the same case as Figure 6, but at a wavelength of  $1.01 \mu\text{m}$  where only two diffraction orders are propagating.

Figure 8 shows a similar plot as Figure 4, but here the polarization of the incident wave is parallel to the plane of incidence.

$\lambda_0(12) = 1.01 \mu\text{m}$  Multislice: Electric field norm (V/m) Arrow Surface: Incident wave (red) Arrow Surface: Reflected wave (blue) Arrow Surface: Mode  $m = -1, n = -1$  (green) Arrow Surface: Mode  $m = 0, n = -1$  (yellow)

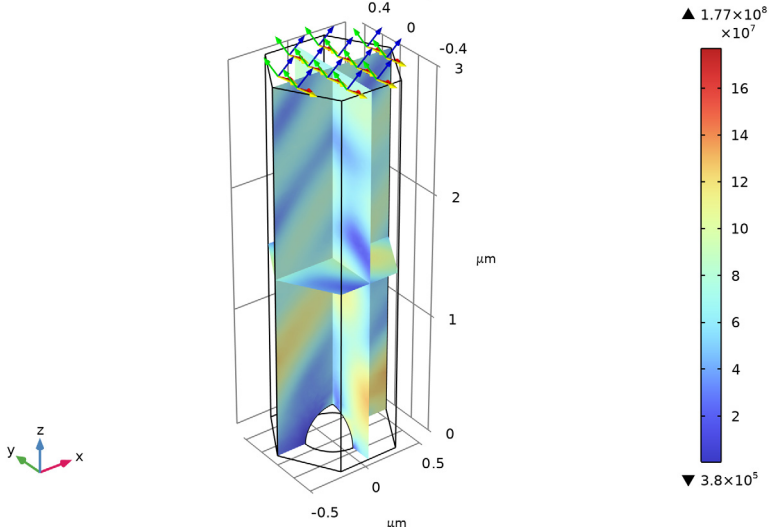

Figure 8: Similar plot as in Figure 4, but here the polarization of the incident wave is parallel to the plane of incidence.

Figure 9 shows that for p-polarization both the reflected wave and the two  $m = -1, n = -1$  modes show resonances close to the critical wavelength for the  $m = 0, n = -1$  mode.

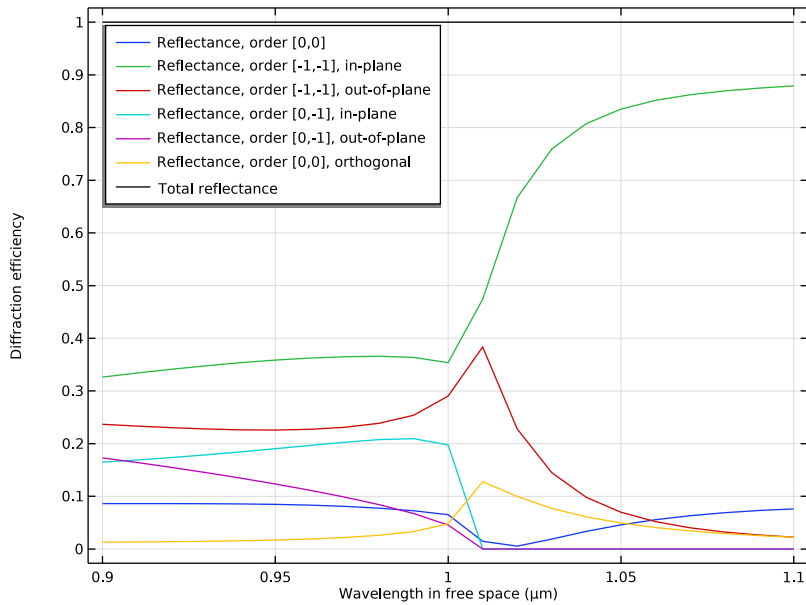

Figure 9: Similar plot as in Figure 5, but here the polarization of the incident wave is parallel to the plane of incidence.

### Notes About the COMSOL Implementation

To define the periodic unit cell, a Periodic Structure node is added. This node automatically adds and configures its subnodes — the periodic port and the three Floquet periodic conditions.

**Application Library path:** Wave\_Optics\_Module/Gratings\_and\_Metamaterials/hexagonal\_grating



### Modeling Instructions

From the **File** menu, choose **New**.

## NEW

In the **New** window, click  **Model Wizard**.

## MODEL WIZARD

- 1 In the **Model Wizard** window, click  **3D**.
- 2 In the **Select Physics** tree, select **Optics > Wave Optics > Electromagnetic Waves, Frequency Domain (ewfd)**.
- 3 Click **Add**.
- 4 Click  **Study**.
- 5 In the **Select Study** tree, select **Preset Studies for Selected Physics Interfaces > Wavelength Domain**.
- 6 Click  **Done**.

## GLOBAL DEFINITIONS

First add some parameters that defines the geometry and the incident electric field.

### *Parameters I*

- 1 In the **Model Builder** window, under **Global Definitions** click **Parameters I**.
- 2 In the **Settings** window for **Parameters**, locate the **Parameters** section.
- 3 In the table, enter the following settings:

Name	Expression	Value	Description
lda0	1 [um]	1E-6 m	Wavelength
a	lda0/2	5E-7 m	Hexagon side length
h0	3*lda0	3E-6 m	Air height
a1	a/2	2.5E-7 m	Sphere radius
theta	pi/3	1.0472	Elevation angle
phi	12[deg]	0.20944 rad	Azimuth angle

Notice that the azimuth angle  $\phi$  above measures the angle for the wave vector of the incident wave from the  $x$ -axis.

## STUDY I

### *Step 1: Wavelength Domain*

- 1 In the **Model Builder** window, under **Study I** click **Step 1: Wavelength Domain**.
- 2 In the **Settings** window for **Wavelength Domain**, locate the **Study Settings** section.

- 3 Click  **Range**.
- 4 In the **Range** dialog, type 0.9[um] in the **Start** text field.
- 5 In the **Step** text field, type 0.01[um].
- 6 In the **Stop** text field, type 1.1[um].
- 7 Click **Replace**.

### GEOMETRY I

- 1 In the **Model Builder** window, under **Component 1 (comp1)** click **Geometry 1**.
- 2 In the **Settings** window for **Geometry**, locate the **Units** section.
- 3 From the **Length unit** list, choose  $\mu\text{m}$ .

The geometry consists of an extruded hexagon, with a semisphere removed from it at the bottom.

*Work Plane 1 (wp1)*

- 1 In the **Geometry** toolbar, click  **Work Plane**.
- 2 In the **Settings** window for **Work Plane**, click  **Go to Plane Geometry**.

*Work Plane 1 (wp1) > Plane Geometry*

In the **Model Builder** window, click **Plane Geometry**.

*Work Plane 1 (wp1) > Polygon 1 (pol1)*

- 1 In the **Work Plane** toolbar, click  **Polygon**.
- 2 In the **Settings** window for **Polygon**, locate the **Coordinates** section.
- 3 In the table, enter the following settings:

xw ( $\mu\text{m}$ )	yw ( $\mu\text{m}$ )
a	0
a/2	$\text{sqrt}(3)/2*a$
-a/2	$\text{sqrt}(3)/2*a$
-a	0
-a/2	$-\text{sqrt}(3)/2*a$
a/2	$-\text{sqrt}(3)/2*a$

*Extrude 1 (ext1)*

- 1 In the **Model Builder** window, right-click **Geometry 1** and choose **Extrude**.
- 2 In the **Settings** window for **Extrude**, locate the **Distances** section.

3 In the table, enter the following settings:

---

**Distances ( $\mu\text{m}$ )**

---





h0

---

*Sphere 1 (sph1)*



- 1 In the **Geometry** toolbar, click  **Sphere**.
- 2 In the **Settings** window for **Sphere**, locate the **Size** section.
- 3 In the **Radius** text field, type a1.

*Difference 1 (dif1)*

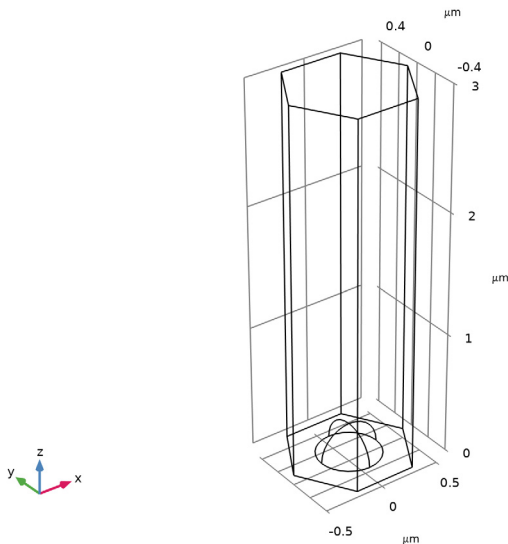
- 1 In the **Geometry** toolbar, click  **Booleans and Partitions** and choose **Difference**.
- 2 Select the object **ext1** only.
- 3 In the **Settings** window for **Difference**, locate the **Difference** section.
- 4 Click to select the  **Activate Selection** toggle button for **Objects to subtract**.
- 5 Select the object **sph1** only.
- 6 Click  **Build All Objects**.
- 7 Click the  **Go to Default View** button in the **Graphics** toolbar.
- 8 Click the  **Wireframe Rendering** button in the **Graphics** toolbar.



## ADD MATERIAL

- 1 In the **Materials** toolbar, click  **Add Material** to open the **Add Material** window.
- 2 Go to the **Add Material** window.
- 3 In the tree, select **Built-in > Air**.
- 4 Click the **Add to Component** button in the window toolbar.
- 5 In the **Materials** toolbar, click  **Add Material** to close the **Add Material** window.

## ELECTROMAGNETIC WAVES, FREQUENCY DOMAIN (EWFD)

### *Periodic Structure I*

- 1 In the **Physics** toolbar, click  **Domains** and choose **Periodic Structure**.
- 2 In the **Settings** window for **Periodic Structure**, locate the **Port Handling** section.
- 3 Clear the **Add listener port** checkbox, as the bottom boundary should use the default **Perfect Electric Conductor I** node.
- 4 Locate the **Port Mode Settings** section. In the  $\alpha_1$  text field, type theta.
- 5 In the  $\alpha_2$  text field, type phi, as this angle is measured from the **Reference Direction** subnode of the **Periodic Structure**.
- 6 In the **Model Builder** window, click **Periodic Structure I**.
- 7 Locate the **Port Handling** section. From the **Diffraction order specification** list, choose **From current parameters**, as no angle sweep will be done in this example model.
- 8 Click **Add Diffraction Orders**.

## MESH 1

In the **Model Builder** window, under **Component 1 (comp1)** right-click **Mesh 1** and choose **Build All**.

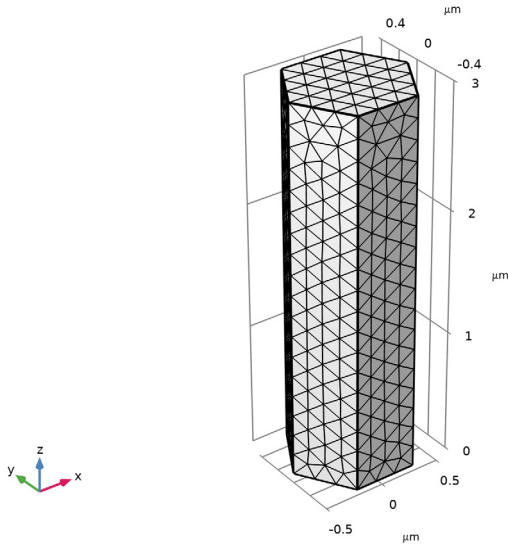

## STUDY 1

In the **Study** toolbar, click  **Compute**.

## RESULTS

Add Arrow Surface plots showing the wave vector directions for the incident field, the reflected field and the diffracted fields. Notice that the diffracted fields come in pairs, where each pair have the same wave vector. Thus, only two wave vectors for the diffraction orders need to be added in this case.

### *Arrow Surface 1*

- 1 Right-click **Electric Field (ewfd)** and choose **Arrow Surface**.
- 2 In the **Settings** window for **Arrow Surface**, click **Replace Expression** in the upper-right corner of the **Expression** section. From the menu, choose **Component 1 (comp1) > Electromagnetic Waves, Frequency Domain > Ports > Wave vectors > ewfd.klnxz\_1,..., ewfd.klnxz\_1 - Incident wave vector**.
- 3 Locate the **Expression** section.
- 4 Select the **Description** checkbox. In the associated text field, type Incident wave (red).

- 5 Locate the **Arrow Positioning** section. In the **Number of arrows** text field, type 12.
- 6 Locate the **Coloring and Style** section.
- 7 Select the **Scale factor** checkbox. In the associated text field, type  $3e-8$ .

#### *Selection 1*

- 1 Right-click **Arrow Surface 1** and choose **Selection**.
- 2 Select Boundary 4 only, to select only the port boundary.

#### *Arrow Surface 2*

- 1 In the **Model Builder** window, under **Results > Electric Field (ewfd)** right-click **Arrow Surface 1** and choose **Duplicate**.
- 2 In the **Settings** window for **Arrow Surface**, click **Replace Expression** in the upper-right corner of the **Expression** section. From the menu, choose **Component 1 (comp1) > Electromagnetic Waves, Frequency Domain > Ports > Wave vectors > ewfd.kModex\_1,..., ewfd.kModex\_1 - Port mode wave vector, port 1**.
- 3 Locate the **Coloring and Style** section. From the **Color** list, choose **Blue**.
- 4 Locate the **Expression** section. In the **Description** text field, type Reflected wave (blue).

#### *Arrow Surface 3*

- 1 Right-click **Arrow Surface 2** and choose **Duplicate**.
- 2 In the **Settings** window for **Arrow Surface**, click **Replace Expression** in the upper-right corner of the **Expression** section. From the menu, choose **Component 1 (comp1) > Electromagnetic Waves, Frequency Domain > Ports > Wave vectors > ewfd.kModex\_3,..., ewfd.kModex\_3 - Port mode wave vector, port 3**.
- 3 Locate the **Coloring and Style** section. From the **Color** list, choose **Green**.
- 4 Locate the **Expression** section. In the **Description** text field, type Mode  $m = -1$ ,  $n = -1$  (green).



#### *Arrow Surface 4*

- 1 Right-click **Arrow Surface 3** and choose **Duplicate**.
- 2 In the **Settings** window for **Arrow Surface**, click **Replace Expression** in the upper-right corner of the **Expression** section. From the menu, choose **Component 1 (comp1) > Electromagnetic Waves, Frequency Domain > Ports > Wave vectors > ewfd.kModex\_5,..., ewfd.kModex\_5 - Port mode wave vector, port 5**.
- 3 Locate the **Coloring and Style** section. From the **Color** list, choose **Yellow**.

- 4 Locate the **Expression** section. In the **Description** text field, type Mode  $m = 0$ ,  $n = -1$  (yellow).

*Electric Field (ewfd)*

Select the wavelength closest to the critical wavelength for the mode  $m = 0$ ,  $n = -1$ .

- 1 In the **Model Builder** window, click **Electric Field (ewfd)**.
- 2 In the **Settings** window for **3D Plot Group**, locate the **Data** section.
- 3 From the **Parameter value (lambda0 (μm))** list, choose **1.01**.
- 4 In the **Electric Field (ewfd)** toolbar, click  **Plot**.
- 5 Click the  **Zoom Extents** button in the **Graphics** toolbar.

lambda0(12)=1.01 μm Multislice: Electric field norm (V/m) Arrow Surface: Incident wave (red) Arrow Surface: Reflected wave (blue) Arrow Surface: Mode  $m = -1$ ,  $n = -1$  (green) Arrow Surface: Mode  $m = 0$ ,  $n = -1$  (yellow)

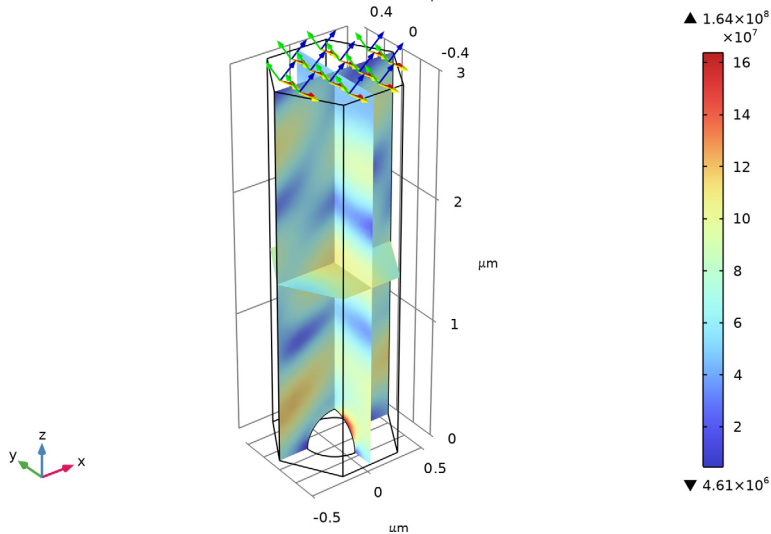

Your plot should look the same as [Figure 4](#).

*Reflectance (ewfd)*

The reflectance and the diffraction efficiencies for the diffracted waves are plotted by default.

- 1 In the **Model Builder** window, click **Reflectance (ewfd)**.
- 2 In the **Settings** window for **ID Plot Group**, click to expand the **Title** section.
- 3 From the **Title type** list, choose **None**.

- 4 Locate the **Plot Settings** section. In the **y-axis label** text field, type **Diffraction efficiency**.
- 5 Locate the **Legend** section. From the **Position** list, choose **Upper left**.
- 6 In the **Reflectance (ewfd)** toolbar, click  **Plot**.

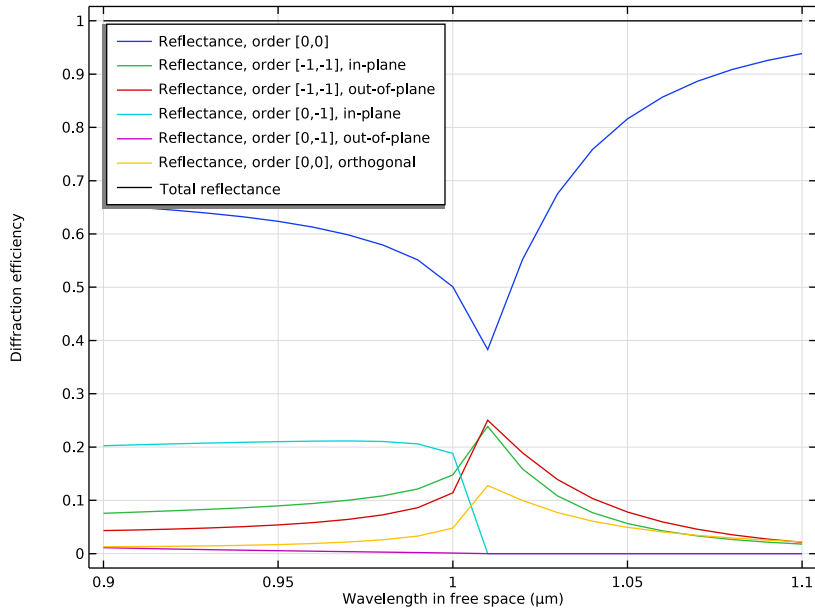

Your plot should look like [Figure 5](#).

#### *Polarization Plot (ewfd)*

- 1 In the **Model Builder** window, click **Polarization Plot (ewfd)**.
- 2 In the **Settings** window for **ID Plot Group**, locate the **Legend** section.
- 3 From the **Layout** list, choose **Outside graph axis area**.
- 4 From the **Position** list, choose **Bottom**.
- 5 In the **Number of rows** text field, type 2.

6 In the **Polarization Plot (ewfd)** toolbar, click  **Plot**.

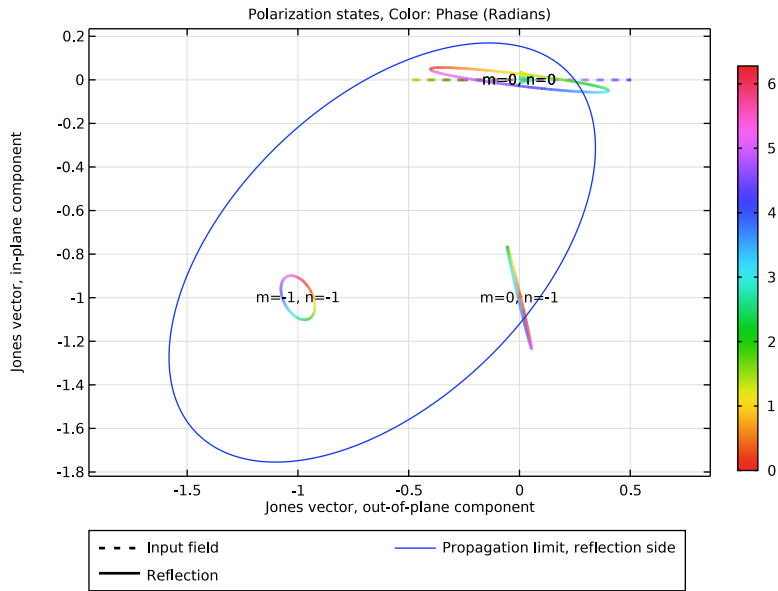

The polarization plot shows that all three modes are elliptically polarized, but with different orientations for the polarization ellipse.

7 Locate the **Data** section. In the **Parameter values (lambda0 (μm))** list box, select **1.01**.

8 In the **Polarization Plot (ewfd)** toolbar, click  **Plot**.

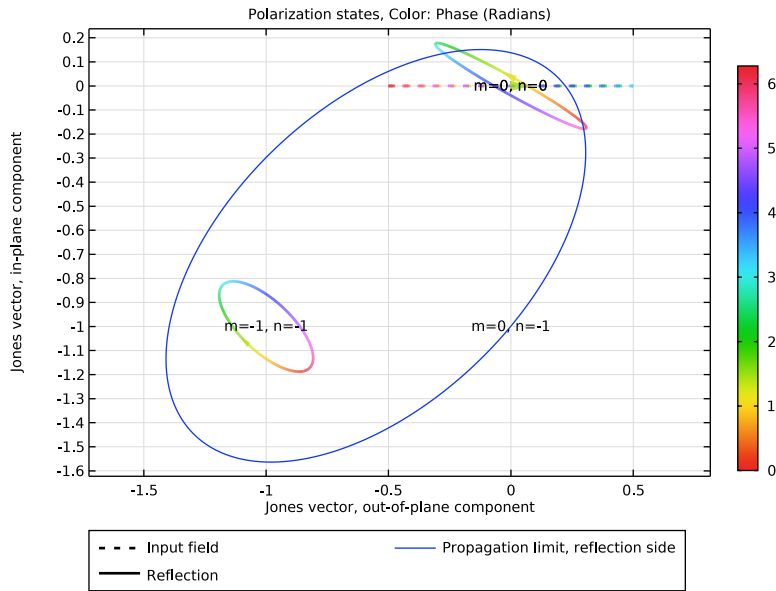

At this wavelength, mode  $m = 0, n = -1$  is evanescent, so there is no polarization ellipse for that mode.

To really understand the polarization direction, you can also plot the Jones base vectors. First create a view zoomed in on the port boundary and then use the view in the created plot.

- 9 Click the  **Show More Options** button in the **Model Builder** toolbar.
- 10 In the **Show More Options** dialog, select **Results > Views** in the tree.
- 11 In the tree, select the checkbox for the node **Results > Views**.
- 12 Click **OK**.

### View 3D 3

- 1 In the **Model Builder** window, under **Results** right-click **Views** and choose **View 3D**.
- 2 Click the **Zoom Box** button in the **Graphics** toolbar and then use the mouse to zoom in on the port boundary.

### Polarization Base Vectors

- 1 In the **Results** toolbar, click  **3D Plot Group**.

- 2 In the **Settings** window for **3D Plot Group**, type Polarization Base Vectors in the **Label** text field.
- 3 Click to expand the **Title** section. From the **Title type** list, choose **None**.
- 4 Locate the **Plot Settings** section. From the **View** list, choose **View 3D 3**.

#### *Out-of-Plane Base Vector*

- 1 Right-click **Polarization Base Vectors** and choose **Arrow Surface**.
- 2 In the **Settings** window for **Arrow Surface**, type Out-of-Plane Base Vector in the **Label** text field.
- 3 Click **Replace Expression** in the upper-right corner of the **Expression** section. From the menu, choose **Component 1 (comp1) > Electromagnetic Waves, Frequency Domain > Ports > Polarization state > Jones base vectors > ewfd.ejROOPx\_0\_0,...,ewfd.ejROOPz\_0\_0 - Jones base vector on reflection side, out-of-plane direction, order [0,0]**.
- 4 Locate the **Arrow Positioning** section. In the **Number of arrows** text field, type 1.

#### *In-Plane Base Vector*

- 1 Right-click **Out-of-Plane Base Vector** and choose **Duplicate**.
- 2 In the **Settings** window for **Arrow Surface**, type In-Plane Base Vector in the **Label** text field.
- 3 Click **Replace Expression** in the upper-right corner of the **Expression** section. From the menu, choose **Component 1 (comp1) > Electromagnetic Waves, Frequency Domain > Ports > Polarization state > Jones base vectors > ewfd.ejRIPx\_0\_0,...,ewfd.ejRIPz\_0\_0 - Jones base vector on reflection side, in-plane direction, order [0,0]**.
- 4 Locate the **Coloring and Style** section. From the **Color** list, choose **Green**.
- 5 Click to expand the **Inherit Style** section. From the **Plot** list, choose **Out-of-Plane Base Vector**.
- 6 Clear the **Color** checkbox.

#### *Normalized Mode Wave Vector*

- 1 Right-click **In-Plane Base Vector** and choose **Duplicate**.
- 2 In the **Settings** window for **Arrow Surface**, type Normalized Mode Wave Vector in the **Label** text field.
- 3 Locate the **Expression** section. In the **X-component** text field, type  $ewfd.kModex_1/ewfd.k$ .
- 4 In the **Y-component** text field, type  $ewfd.kModey_1/ewfd.k$ .
- 5 In the **Z-component** text field, type  $ewfd.kModez_1/ewfd.k$ .

- 6 Locate the **Coloring and Style** section. From the **Color** list, choose **Blue**.

*Selection 1*

- 1 Right-click **Normalized Mode Wave Vector** and choose **Selection**, to only show the wave vector on the port boundary.
- 2 Select Boundary 4 only.

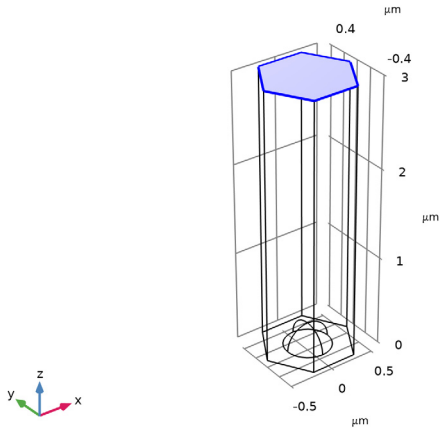

*Boundary Normal*

- 1 In the **Model Builder** window, right-click **Normalized Mode Wave Vector** and choose **Duplicate**.
- 2 In the **Settings** window for **Arrow Surface**, type Boundary Normal in the **Label** text field.
- 3 In the **Model Builder** window, click **Boundary Normal**.
- 4 Click **Replace Expression** in the upper-right corner of the **Expression** section. From the menu, choose **Component 1 (comp1) > Electromagnetic Waves, Frequency Domain > Geometry and mesh > ewfd.nx,ewfd.ny,ewfd.nz - Normal vector**.
- 5 Locate the **Coloring and Style** section. From the **Color** list, choose **Black**.
- 6 In the **Polarization Base Vectors** toolbar, click  **Plot**.

7 Zoom-in and move the plot, to make the vectors appear as in the picture below.

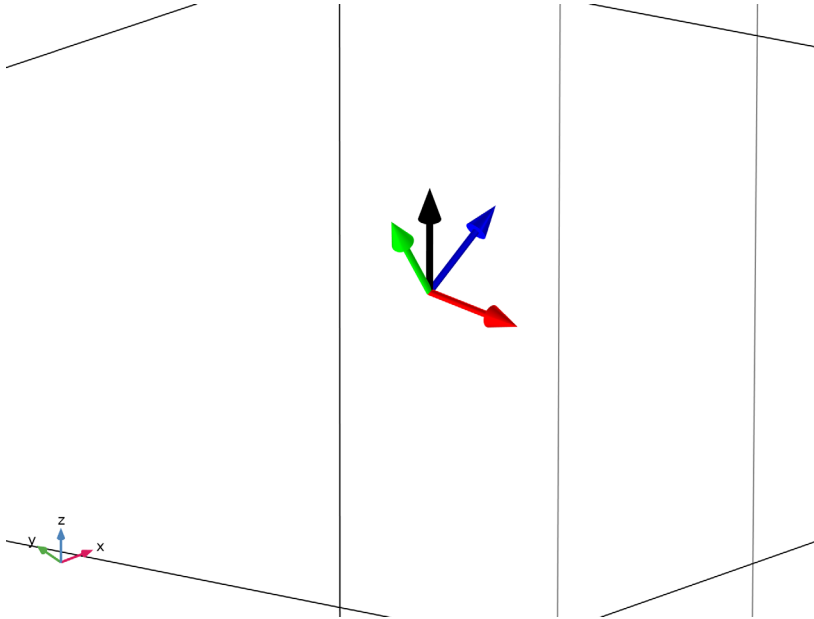

As shown, the out-of-plane base vector (red) is orthogonal to the plane spanned by the port normal (black) and the mode's wave vector (blue). The in-plane base vector (green) is parallel to the plane spanned by the port normal and the mode's wave vector.

#### *Out-of-Plane Base Vector*

Change the arrow expressions to visualize the behavior for mode  $m = -1, n = -1$  to demonstrate that the base vectors are different for the different modes.

- 1 In the **Model Builder** window, click **Out-of-Plane Base Vector**.
- 2 In the **Settings** window for **Arrow Surface**, locate the **Expression** section.
- 3 In the **X-component** text field, type `ewfd.eJR00Px_n1_n1`.
- 4 In the **Y-component** text field, type `ewfd.eJR00Py_n1_n1`.
- 5 In the **Z-component** text field, type `ewfd.eJR00Pz_n1_n1`.

Here, the variable suffix  $n1\_n1$  represents the mode number  $m = -1, n = -1$ .

#### *In-Plane Base Vector*

- 1 In the **Model Builder** window, click **In-Plane Base Vector**.
- 2 In the **Settings** window for **Arrow Surface**, locate the **Expression** section.
- 3 In the **X-component** text field, type `ewfd.eJRIPx_n1_n1`.

- 4 In the **Y-component** text field, type `ewfd.eJRIPy_n1_n1`.
- 5 In the **Z-component** text field, type `ewfd.eJRIPz_n1_n1`.

*Normalized Mode Wave Vector*

- 1 In the **Model Builder** window, click **Normalized Mode Wave Vector**.
- 2 In the **Settings** window for **Arrow Surface**, locate the **Expression** section.
- 3 In the **X-component** text field, type `ewfd.kModex_3/ewfd.k`.
- 4 In the **Y-component** text field, type `ewfd.kModey_3/ewfd.k`.
- 5 In the **Z-component** text field, type `ewfd.kModez_3/ewfd.k`.

Here, the variable suffix is the port name, not the mode number.

- 6 In the **Polarization Base Vectors** toolbar, click  **Plot**.

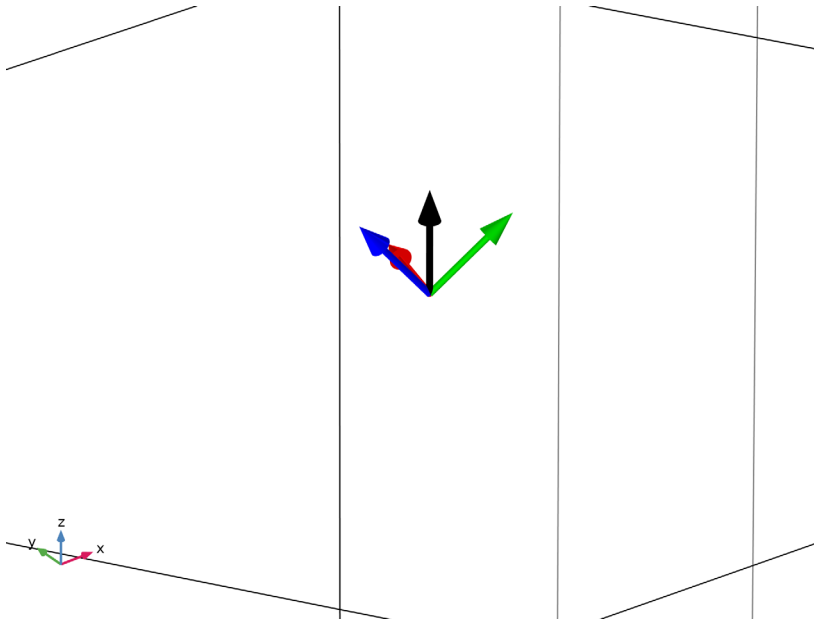

As shown, the wave vector and the polarization vectors are different for this mode, compared to the vectors for the zero order mode.

## **ELECTROMAGNETIC WAVES, FREQUENCY DOMAIN (EWF D)**

### *Periodic Structure 1*

Now, repeat the simulation for an incoming wave with p-polarization (the electric field polarized in the plane of incidence).

- 1 In the **Model Builder** window, under **Component 1 (comp1) > Electromagnetic Waves, Frequency Domain (ewfd)** click **Periodic Structure 1**.
- 2 In the **Settings** window for **Periodic Structure**, locate the **Port Mode Settings** section.
- 3 From the list, choose **P**.
- 4 In the **Home** toolbar, click **Compute**.

## RESULTS

### *Electric Field (ewfd)*

- 1 Click the  **Zoom Extents** button in the **Graphics** toolbar, and verify that your plot look the same as [Figure 8](#).

lambda0(12)=1.01  $\mu\text{m}$  Multislice: Electric field norm (V/m) Arrow Surface: Incident wave (red) Arrow Surface: Reflected wave (blue) Arrow Surface: Mode m = -1, n = -1 (green) Arrow Surface: Mode m = 0, n = -1 (yellow)

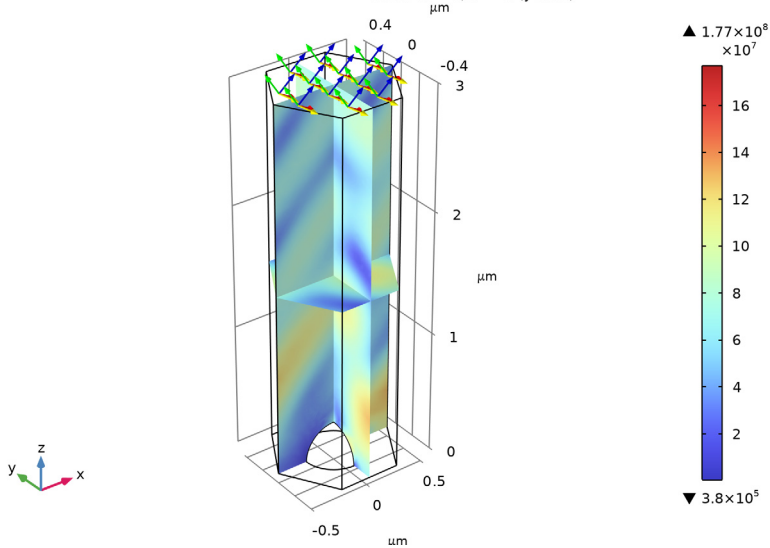

### *Reflectance (ewfd)*

- 1 In the **Model Builder** window, click **Reflectance (ewfd)**.

2 In the **Reflectance (ewfd)** toolbar, click  **Plot**, and verify that your plot look the same as [Figure 9](#).

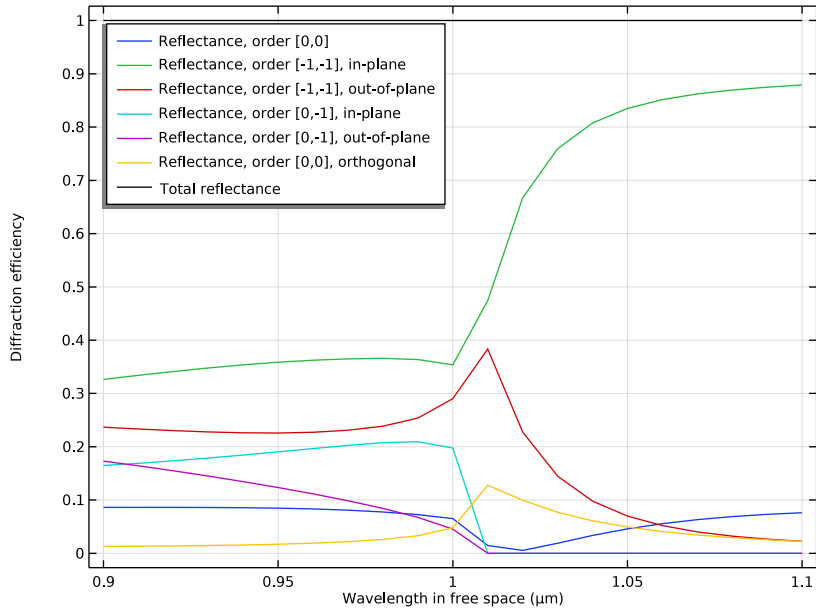

### *Polarization Plot (ewfd)*

Finally, take a look at the polarization states when the input wave is p-polarized.

1 In the **Model Builder** window, click **Polarization Plot (ewfd)**.

2 In the **Settings** window for **ID Plot Group**, click **Plot First**.

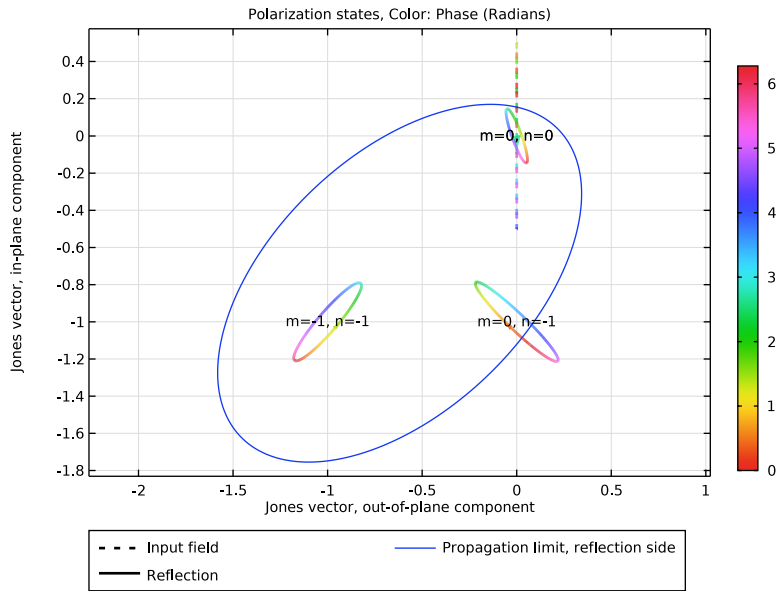

Also in this case, the polarization is elliptical for the different modes.

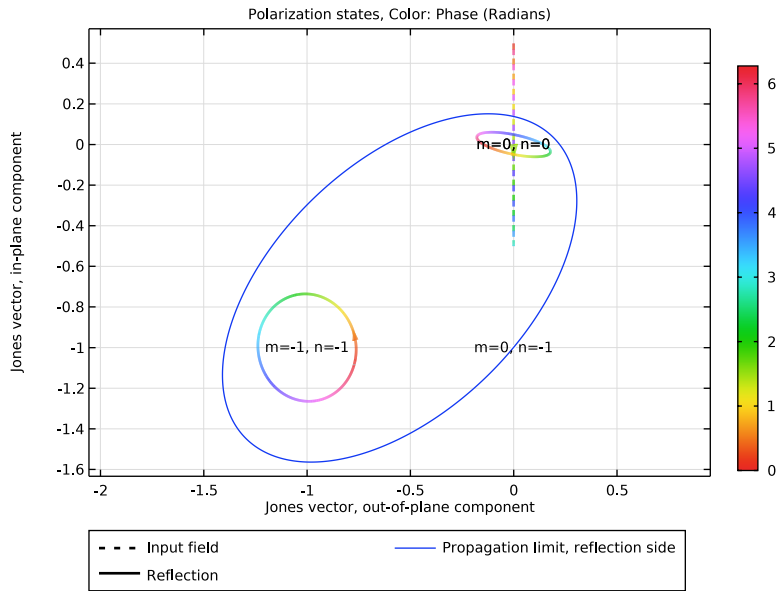

3 Locate the **Data** section. In the **Parameter values ( $\lambda_0$  ( $\mu\text{m}$ ))** list box, select **1.01**.

4 In the **Polarization Plot (ewfd)** toolbar, click  **Plot**.



At this wavelength, close the resonance, the polarization for the  $m = 0, n = 0$  mode switches to almost out-of-plane polarization, whereas the  $m = -1, n = -1$  mode has almost circular polarization. The relative magnitude of the Jones vector elements is also reflected in the diffraction efficiency plot above.

#### Preferred Units I

- 1 In the **Results** toolbar, click  **Configurations** and choose **Preferred Units**.
- 2 In the **Settings** window for **Preferred Units**, locate the **Units** section.
- 3 Click  **Add Physical Quantity**.
- 4 In the **Physical Quantity** dialog, type `plane` in the text field.
- 5 In the tree, select **General > Plane angle (rad)**.
- 6 Click **OK**.
- 7 In the **Settings** window for **Preferred Units**, locate the **Units** section.
- 8 In the table, enter the following settings:

Quantity	Unit	Preferred unit
Plane angle	rad	°

### *Diffraction Angles (ewfd)*

- 1 In the **Results** toolbar, click  **ID Plot Group**.
- 2 In the **Settings** window for **ID Plot Group**, type **Diffraction Angles (ewfd)** in the **Label** text field.

### *Global 1*

- 1 Right-click **Diffraction Angles (ewfd)** and choose **Global**.
- 2 In the **Settings** window for **Global**, click **Replace Expression** in the upper-right corner of the **y-Axis Data** section. From the menu, choose **Component 1 (comp1) > Electromagnetic Waves, Frequency Domain > Ports > Elevation angle, by order > All expressions in this group**.
- 3 Locate the **x-Axis Data** section. From the **Parameter** list, choose **Expression**.
- 4 In the **Expression** text field, type `ewfd.lambd0`.
- 5 Click to expand the **Legends** section. Find the **Include** subsection. Clear the **Solution** checkbox.

### *Global 2*

- 1 Right-click **Global 1** and choose **Duplicate**.
- 2 In the **Settings** window for **Global**, click **Replace Expression** in the upper-right corner of the **y-Axis Data** section. From the menu, choose **Component 1 (comp1) > Electromagnetic Waves, Frequency Domain > Ports > Azimuth angle, by order > All expressions in this group**.
- 3 Click to expand the **Coloring and Style** section. Find the **Line style** subsection. From the **Line** list, choose **None**.
- 4 From the **Color** list, choose **Cycle (reset)**.
- 5 Find the **Line markers** subsection. From the **Marker** list, choose **Cycle**.
- 6 In the **Diffraction Angles (ewfd)** toolbar, click  **Plot**.

### *Diffraction Angles (ewfd)*

- 1 In the **Model Builder** window, click **Diffraction Angles (ewfd)**.
- 2 In the **Settings** window for **ID Plot Group**, click to expand the **Title** section.
- 3 From the **Title type** list, choose **None**.
- 4 Locate the **Plot Settings** section.
- 5 Select the **y-axis label** checkbox. In the associated text field, type **Diffraction angles (degrees)**.
- 6 Locate the **Legend** section. From the **Layout** list, choose **Outside graph axis area**.

- 7 From the **Position** list, choose **Bottom**.
- 8 In the **Number of rows** text field, type 3.
- 9 In the **Diffraction Angles (ewfd)** toolbar, click  **Plot**.

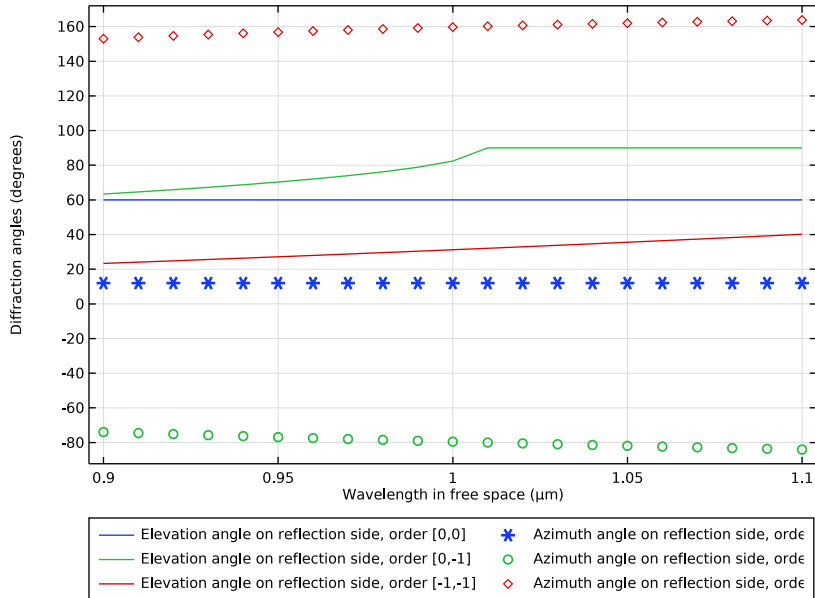

Notice that the wavelength dependence for the elevation and azimuth angles is very small for  $m = n = 0$ , whereas there is some wavelength dependence for the higher-order modes.