



Model created in COMSOL Multiphysics 6.4

# Dam Breaking on a Column, Shallow Water Equations

## Introduction

---

Wave impact problems are important in engineering of structures, for example in locations where tsunamis are probable. Predicting the forces of waves acting on objects can be crucial for offshore structures and structures placed near water. If the structure is subjected to high waves, flooding must also be accounted for. One of the simplest, but widely used, systems of equations used to model this kind of problem are the shallow water equations.

This transient model solves the shallow water equations to model the impact of a water wave on a column. A body of water with a height of 0.3 m is initially contained behind a gate. At the start of the simulation, the gate is suddenly released and the body of water forms a wave moving toward the structure. After impacting, the water continues its forward movement until it is reflected from the wall of the tank and impinges the second time on the other side of the column. The pressure force on the column is computed and can be compared with the experimental results available in [Ref. 1](#), and with the results obtained using the Two-Phase Flow, Level Set interface in the *Dam Breaking on a Column, Level Set* example in the CFD Module Application Library.

## Model Definition

---

The geometry and initial configuration of the experiment is depicted in [Figure 1](#). A 1.60 m long, 0.61 m wide, and 0.60 m high tank was used. A 0.40 m long, 0.61 m wide, and 0.30 m high volume of water is initially contained behind a gate which is instantly released at the start of the simulation. A tall solid column with 0.12 m wide square base is placed inside the tank 0.50 m downstream of the wall and 0.25 m from one of the sidewalls. The experimental facility did not allow for a complete drainage of the tank so a thin layer of water of approximately 0.01 m is also accounted for.

Using the Shallow Water Equations, Time Explicit physics interface, the problem is solved in a 2D domain. The bottom of the tank is defined entering an expression for the bottom height in the Domain Properties feature. The lateral walls are modeled with the Wall feature. The initial height of the water is defined using the Initial Values feature. In this model the column is represented using the Wall feature. More complicated objects that could be flooded with water should be modeled entering an expression for the bottom height  $h_b$  instead.

The physics interface provides variables to compute the pressure force acting on boundaries. In the shallow water equations the pressure is assumed to be hydrostatic

$$p = \rho g(h + h_b - z)$$

The pressure force per unit length on a boundary can be obtained integrating along  $h$ :

$$\mathbf{F}_p = \int_0^h \rho g z \mathbf{n} dz = \rho g \frac{h^2}{2} \mathbf{n}$$

The components of the vector  $\mathbf{F}_p$  can be accessed in 2D using the variables  $swe.Fpx$  and  $swe.Fpy$ . Note that these variables represent a force per unit length, the total force on a boundary is obtained integrating over the whole boundary.

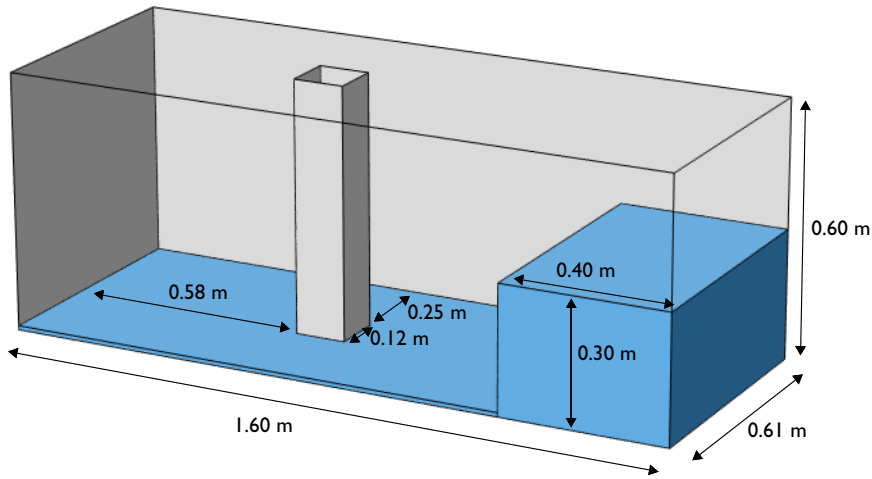

*Figure 1: Geometry and initial water configuration.*

### *Results and Discussion*

[Figure 2](#) shows the position of the free surface at various times. After the release of the gate, the body of water collapses due to gravity and forms a wave moving toward the column. After impacting on the structure the wave front is torn so that its central part rides up the column's upstream face. The sides of the wave rejoin in the wake downstream the structure and are reflected by the downstream wall of the tank. The wave is weakened after the reflection and impinges again on the column from the downstream side. The wave continues toward the upstream wall where it is reflected once more, but it is gradually decaying.

The net  $y$ -component of the pressure force acting on the column is plotted in [Figure 3](#). The computed force captures the impact of the water on the front and back parts of the

structure with maxima at  $t = 0.3$  s and  $t = 1.4$  s, respectively. Compared with the measured forces reported in Ref. 1, the agreement is good. The maximum and minimum values of the force are over predicted, but the trend of the force can be successfully captured using a simplified model as the shallow water equations.

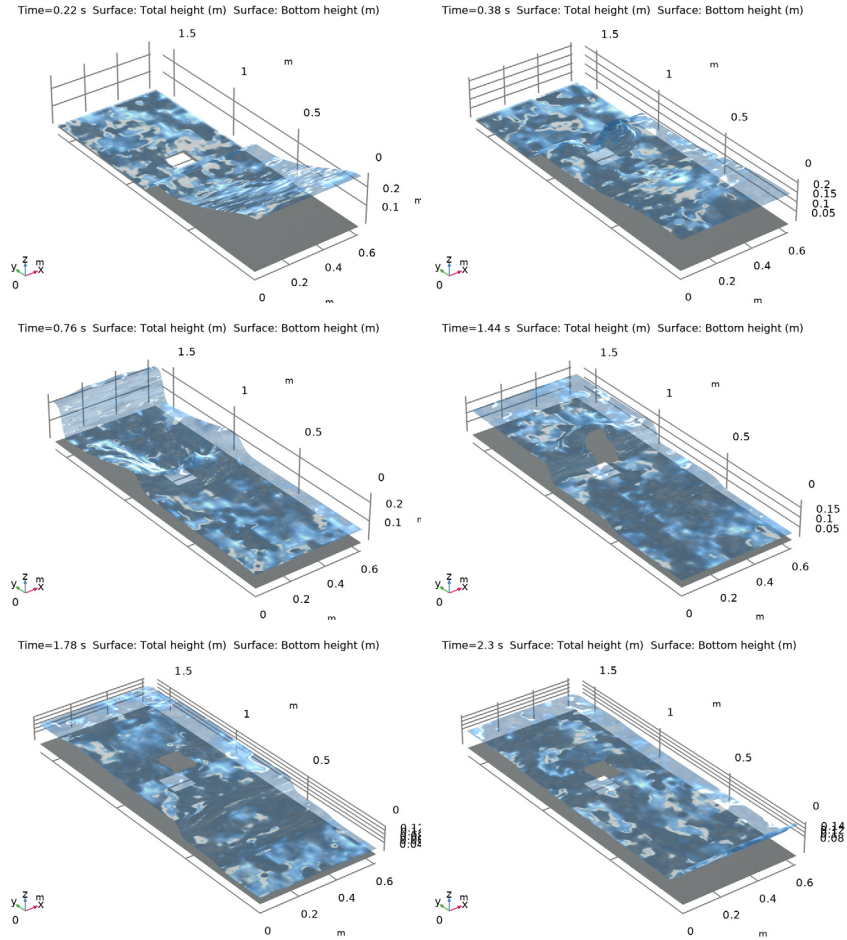

Figure 2: Water free surface at  $t = 0.22$  s,  $0.38$  s,  $0.76$  s,  $1.44$  s,  $1.78$  s, and  $2.30$  s.

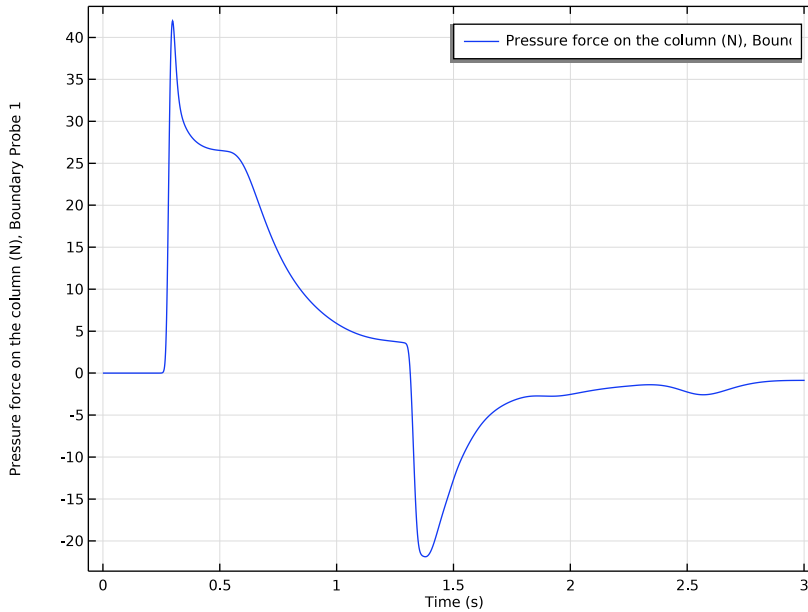

Figure 3: Force in the  $y$  direction acting on the structure.

### References

1. P.E. Raad and R. Bidoac, “The three-dimensional Eulerian-Lagrangian marker and micro cell method for the simulation of free surface flows,” *J. Comput. Phys.*, vol. 203, pp. 668–699, 2005.

---

**Application Library path:** Subsurface\_Flow\_Module/Fluid\_Flow/  
dam\_break\_column\_sw

---



### Modeling Instructions

From the **File** menu, choose **New**.

#### NEW

In the **New** window, click  **Model Wizard**.

## MODEL WIZARD

- 1 In the **Model Wizard** window, click  **2D**.
- 2 In the **Select Physics** tree, select **Fluid Flow > Shallow Water Equations > Shallow Water Equations, Time Explicit (swe)**.
- 3 Click **Add**.
- 4 Click  **Study**.
- 5 In the **Select Study** tree, select **Preset Studies for Selected Physics Interfaces > Time Dependent**.
- 6 Click  **Done**.

## GEOMETRY I

### *Rectangle 1 (r1)*



- 1 In the **Geometry** toolbar, click  **Rectangle**.
- 2 In the **Settings** window for **Rectangle**, locate the **Size and Shape** section.
- 3 In the **Width** text field, type 0.61.
- 4 In the **Height** text field, type 1.6.
- 5 Click to expand the **Layers** section. In the table, enter the following settings:

Layer name	Thickness (m)
Layer 1	0.4

### *Square 1 (sq1)*

- 1 In the **Geometry** toolbar, click  **Square**.
- 2 In the **Settings** window for **Square**, locate the **Size** section.
- 3 In the **Side length** text field, type 0.12.
- 4 Locate the **Position** section. In the **x** text field, type 0.24.
- 5 In the **y** text field, type 0.9.

### *Difference 1 (dif1)*

- 1 In the **Geometry** toolbar, click  **Booleans and Partitions** and choose **Difference**.
- 2 Select the object **r1** only.
- 3 In the **Settings** window for **Difference**, locate the **Difference** section.
- 4 Click to select the  **Activate Selection** toggle button for **Objects to subtract**.
- 5 Select the object **sq1** only.
- 6 Click  **Build All Objects**.

## SHALLOW WATER EQUATIONS, TIME EXPLICIT (SWE)

### Initial Values 1

- 1 In the **Model Builder** window, under **Component 1 (comp1) > Shallow Water Equations, Time Explicit (swe)** click **Initial Values 1**.
- 2 In the **Settings** window for **Initial Values**, locate the **Initial Values** section.
- 3 In the  $h$  text field, type 0.01.



### Initial Values 2

- 1 In the **Physics** toolbar, click  **Domains** and choose **Initial Values**.
- 2 Select Domain 1 only.
- 3 In the **Settings** window for **Initial Values**, locate the **Initial Values** section.
- 4 In the  $h$  text field, type 0.3.

## DEFINITIONS

Add a Boundary Probe to compute the pressure force acting on the column.

### Boundary Probe 1 (bnd1)

- 1 In the **Definitions** toolbar, click  **Probes** and choose **Boundary Probe**.
- 2 In the **Settings** window for **Boundary Probe**, type  $F_p$  in the **Variable name** text field.
- 3 Locate the **Probe Type** section. From the **Type** list, choose **Integral**.
- 4 Locate the **Source Selection** section. From the **Selection** list, choose **Manual**.
- 5 Click  **Clear Selection**.
- 6 Select Boundaries 7 and 8 only.
- 7 Locate the **Expression** section. In the **Expression** text field, type  $swe.F_{py}$ .
- 8 Select the **Description** checkbox. In the associated text field, type Pressure force on the column.

## MESH 1

- 1 In the **Model Builder** window, under **Component 1 (comp1)** click **Mesh 1**.
- 2 In the **Settings** window for **Mesh**, locate the **Physics-Controlled Mesh** section.
- 3 From the **Element size** list, choose **Finer**.
- 4 Click  **Build All**.

## STUDY I

### *Step 2: Time Dependent*

- 1 In the **Model Builder** window, under **Study I** click **Step 2: Time Dependent**.
- 2 In the **Settings** window for **Time Dependent**, locate the **Study Settings** section.
- 3 In the **Output times** text field, type range (0,0.01,3).
- 4 In the **Study** toolbar, click  **Get Initial Value**.

## RESULTS

### *Total Height (swe)*

In the **Model Builder** window, expand the **Total Height (swe)** node.

### *Height Expression 1*

- 1 In the **Model Builder** window, expand the **Results > Total Height (swe) > Total Height** node, then click **Height Expression 1**.
- 2 In the **Settings** window for **Height Expression**, locate the **Axis** section.
- 3 Select the **Scale factor** checkbox.

## STUDY I

In the **Study** toolbar, click  **Compute**.

## RESULTS

### *Total Height (swe)*

- 1 In the **Settings** window for **2D Plot Group**, locate the **Data** section.
- 2 From the **Time (s)** list, choose **0.38**.
- 3 In the **Total Height (swe)** toolbar, click  **Plot**.