



Model created in COMSOL Multiphysics 6.4

Viscoelastic Structural Damper

Introduction

The example studies a forced response of a typical viscoelastic damper. Damping elements involving layers of viscoelastic materials are often used for reduction of seismic and wind induced vibrations in buildings and other tall structures. The common feature is that the frequency of the forced vibrations is low.

Model Definition

The geometry of the viscoelastic damper is shown in [Figure 1](#) (from [Ref. 1](#)). The damper consists of two layers of viscoelastic material confined between mounting elements made of steel.

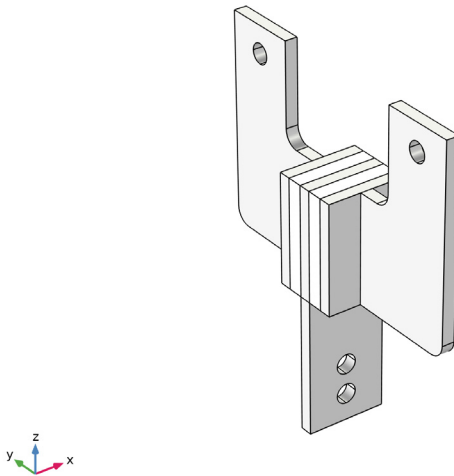
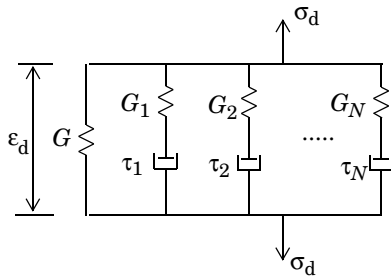

Figure 1: Viscoelastic damping element.

The viscoelastic layers are modeled with the generalized Maxwell model available in COMSOL Multiphysics. The generalized Maxwell model represents the viscoelastic material as a series of branches, each with a spring-dashpot pair.



Eighteen viscoelastic branches guarantee accurate representation of the material behavior for a wide range of excitation frequencies, when the damper is subjected to forced vibration. The values of the shear moduli and relaxation times for each branch are available in Ref. 1. They are summarized in the following table:

TABLE 1: MODEL DATA FOR THE VISCOELASTIC DAMPER MODEL.

Property	Value	Description
G	58.6 kPa	Long time shear modulus
ρ	1.06 g/cm ³	Density
G_1	13.3 MPa	Shear modulus, branch 1
τ_1	10 ⁻⁷ s	Relaxation time, branch 1
G_2	286 MPa	Shear modulus, branch 2
τ_2	10 ⁻⁶ s	Relaxation time, branch 2
G_3	291 MPa	Shear modulus, branch 3
τ_3	3.16·10 ⁻⁶ s	Relaxation time, branch 3
G_4	212 MPa	Shear modulus, branch 4
τ_4	10 ⁻⁵ s	Relaxation time, branch 4
G_5	112 MPa	Shear modulus, branch 5
τ_5	3.16·10 ⁻⁵ s	Relaxation time, branch 5
G_6	61.6 MPa	Shear modulus, branch 6
τ_6	10 ⁻⁴ s	Relaxation time, branch 6
G_7	29.8 MPa	Shear modulus, branch 7
τ_7	3.16·10 ⁻⁴ s	Relaxation time, branch 7
G_8	16.1 MPa	Shear modulus, branch 8
τ_8	10 ⁻³ s	Relaxation time, branch 8
G_9	7.83 MPa	Shear modulus, branch 9
τ_9	3.16·10 ⁻³ s	Relaxation time, branch 9
G_{10}	4.15 MPa	Shear modulus, branch 10
τ_{10}	10 ⁻² s	Relaxation time, branch 10
G_{11}	2.03 MPa	Shear modulus, branch 11
τ_{11}	3.16·10 ⁻² s	Relaxation time, branch 11
G_{12}	1.11 MPa	Shear modulus, branch 12
τ_{12}	0.1 s	Relaxation time, branch 12
G_{13}	0.491 MPa	Shear modulus, branch 13

TABLE 1: MODEL DATA FOR THE VISCOELASTIC DAMPER MODEL.

Property	Value	Description
τ_{13}	0.316 s	Relaxation time, branch 13
G_{14}	0.326 MPa	Shear modulus branch 14
τ_{14}	1 s	Relaxation time branch 14
G_{15}	$8.25 \cdot 10^{-2}$ MPa	Shear modulus branch 15
τ_{15}	3.16 s	Relaxation time branch 15
G_{16}	0.126 MPa	Shear modulus branch 16
τ_{16}	10 s	Relaxation time branch 16
G_{17}	$3.73 \cdot 10^{-2}$ MPa	Shear modulus branch 17
τ_{17}	100 s	Relaxation time branch 17
G_{18}	$1.18 \cdot 10^{-2}$ MPa	Shear modulus branch 18
τ_{18}	1000 s	Relaxation time branch 18

One of the mounting elements is fixed; the other two are loaded with periodic forces with frequencies in the range 0–5 Hz.

The time-domain representation of the forced solution is computed using the fast Fourier transform (FFT).

Results and Discussion

The harmonic response at 3 Hz is shown in [Figure 2](#).

In the frequency domain, the viscoelastic properties of the material appear as the storage modulus and loss modulus. The computed variation of the viscoelastic moduli with frequency is shown in [Figure 3](#). The result is in very good agreement with the experimental data (Figure 7 in [Ref. 2](#))

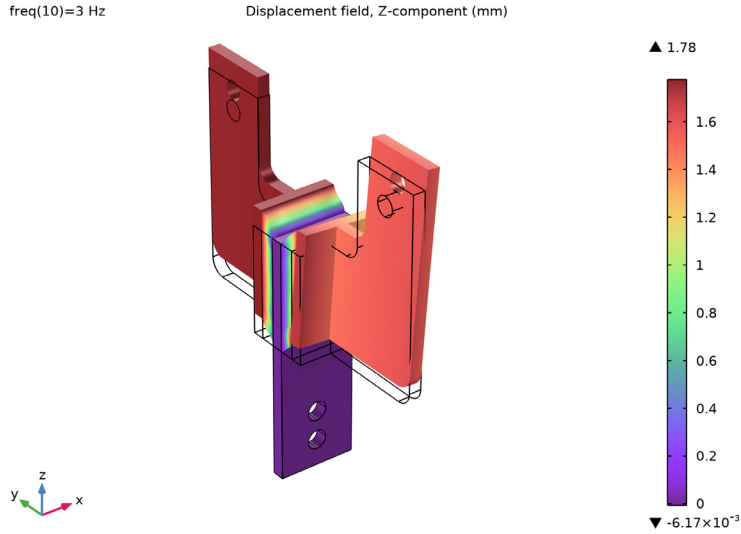

Figure 2: Vertical displacement of the damper, harmonic response.

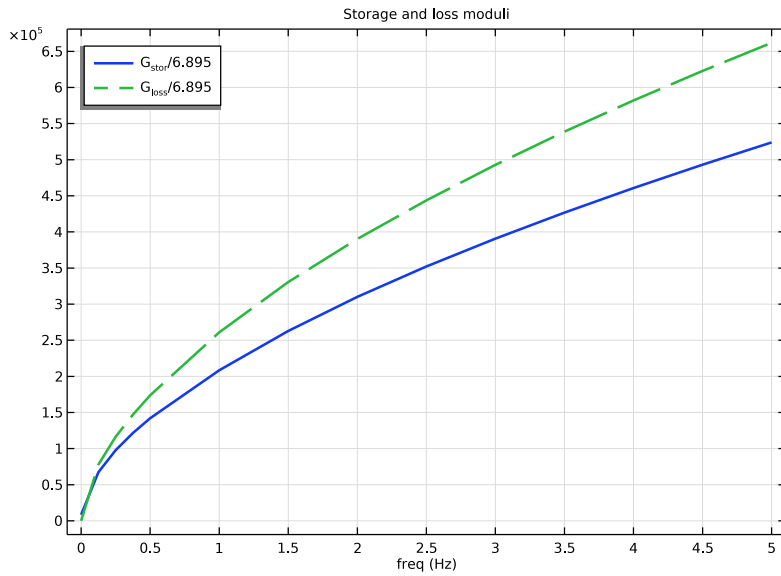

Figure 3: Viscoelastic storage modulus (solid line) and loss modulus (dashed line). Both quantities are normalized by 6.895 to simplify the comparison with Ref. 2.

The time-domain solution obtained from an FFT for the case of an excitation frequency of 3 Hz is shown in [Figure 4](#).

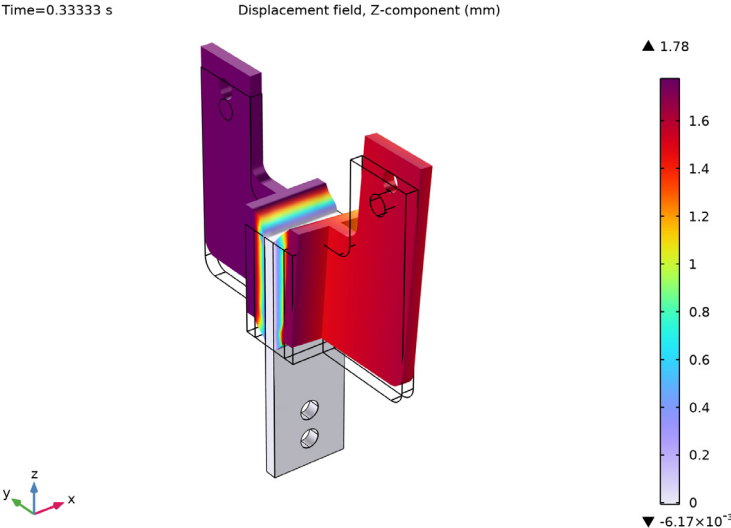

Figure 4: Displacement of the damper after 1/3 second of forced vibrations.

Finally, the total vertical force versus vertical displacement for one of the mounting holes is shown in [Figure 5](#).

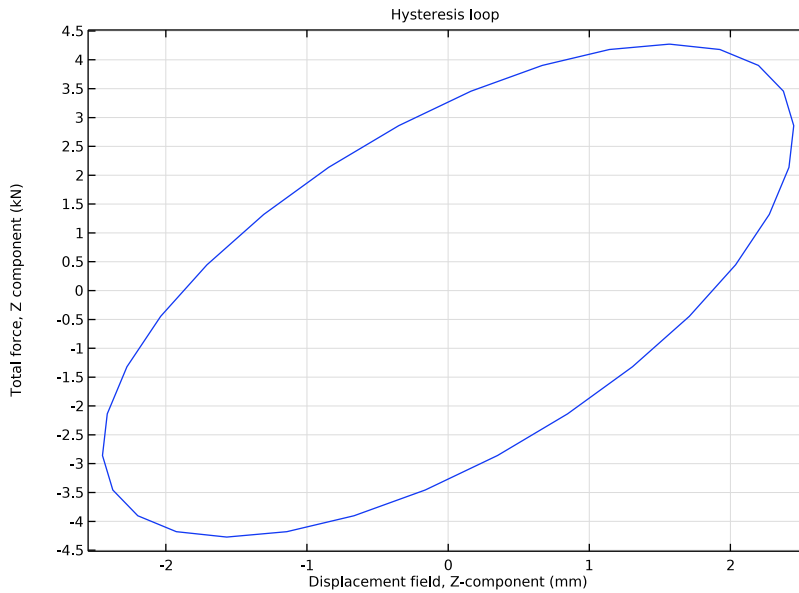

Figure 5: Hysteresis loop for an excitation frequency of 3 Hz over the time interval of 1/3 s.

Notes About the COMSOL Implementation

You create this model in 3D and use the Solid Mechanics interface with a **Linear Elastic Material** and then add the **Viscoelasticity** node to the domains representing the viscoelastic layers.

References

1. S.W. Park “Analytical Modeling of Viscoelastic Dampers for Structural and Vibration Control,” *Int. J. Solids and Structures*, vol. 38, pp. 694–701, 2001.
2. K.L. Shen and T.T. Soong, “Modeling of Viscoelastic Dampers for Structural Applications,” *J. Eng. Mech.*, vol. 121, pp. 694–701, 1995.

Application Library path: Structural_Mechanics_Module/
Dynamics_and_Vibration/viscoelastic_damper_frequency



Modeling Instructions

From the **File** menu, choose **New**.

NEW



In the **New** window, click  **Model Wizard**.

MODEL WIZARD

- 1 In the **Model Wizard** window, click  **3D**.
- 2 In the **Select Physics** tree, select **Structural Mechanics > Solid Mechanics (solid)**.
- 3 Click **Add**.
- 4 Click  **Study**.
- 5 In the **Select Study** tree, select **General Studies > Frequency Domain**.
- 6 Click  **Done**.

GEOMETRY I

Import the predefined geometry from a file.

- 1 In the **Geometry** toolbar, click **Insert Sequence** and choose **Insert Sequence**.
- 2 Browse to the model's Application Libraries folder and double-click the file `viscoelastic_damper_geom_sequence.mph`.
- 3 Click the  **Zoom Extents** button in the **Graphics** toolbar.
- 4 Click the  **Show Grid** button in the **Graphics** toolbar.

The imported geometry should look similar to that shown in [Figure 1](#).



SOLID MECHANICS (SOLID)

Linear Elastic Material 2

- 1 In the **Physics** toolbar, click  **Domains** and choose **Linear Elastic Material**.
- 2 In the **Settings** window for **Linear Elastic Material**, locate the **Linear Elastic Material** section.
- 3 From the **Specify** list, choose **Bulk modulus and shear modulus**.

- 4 From the **Use mixed formulation** list, choose **Pressure formulation**.
- 5 Select Domains 2 and 5 only.

Viscoelasticity I

- 1 In the **Physics** toolbar, click  **Attributes** and choose **Viscoelasticity**.
Since there are 18 branches in this material model, the data has been collected in a text file which you can load.
- 2 In the **Settings** window for **Viscoelasticity**, locate the **Viscoelasticity Model** section.
- 3 Click to select the first row in the table.
- 4 Click  **Delete**.
- 5 Click  **Load from File**.
- 6 Browse to the model's Application Libraries folder and double-click the file `viscoelastic_damper_viscoelastic_data.txt`.

ADD MATERIAL

- 1 In the **Home** toolbar, click  **Add Material** to open the **Add Material** window.
- 2 Go to the **Add Material** window.
- 3 In the tree, select **Built-in > Steel AISI 4340**.
- 4 Click the **Add to Component** button in the window toolbar.



MATERIALS

Viscoelastic

- 1 In the **Model Builder** window, under **Component 1 (comp1)** right-click **Materials** and choose **Blank Material**.
- 2 In the **Settings** window for **Material**, type **Viscoelastic** in the **Label** text field.
- 3 Select Domains 2 and 5 only.
- 4 Locate the **Material Contents** section. In the table, enter the following settings:

Property	Variable	Value	Unit	Property group
Bulk modulus	K	4e8	N/m ²	Bulk modulus and shear modulus
Shear modulus	G	5.86e4	N/m ²	Bulk modulus and shear modulus
Density	rho	1060	kg/m ³	Basic

- 5 In the **Materials** toolbar, click  **Add Material** to close the **Add Material** window.

- 6 In the **Settings** window for **Materials**, in the **Graphics** window toolbar, click  next to  **Colors**, then choose **Show Material Color and Texture**.

SOLID MECHANICS (SOLID)

Fixed Constraint I

- 1 In the **Physics** toolbar, click  **Boundaries** and choose **Fixed Constraint**.
- 2 In the **Settings** window for **Fixed Constraint**, locate the **Boundary Selection** section.
- 3 From the **Selection** list, choose **Bottom Holes**.

Prescribed Displacement I

- 1 In the **Physics** toolbar, click  **Boundaries** and choose **Prescribed Displacement**.
- 2 In the **Settings** window for **Prescribed Displacement**, locate the **Boundary Selection** section.
- 3 From the **Selection** list, choose **Right Hole**.
- 4 Locate the **Prescribed Displacement** section. From the **Displacement in x direction** list, choose **Prescribed**.
- 5 From the **Displacement in y direction** list, choose **Prescribed**.

Boundary Load I

- 1 In the **Physics** toolbar, click  **Boundaries** and choose **Boundary Load**.
- 2 In the **Settings** window for **Boundary Load**, locate the **Boundary Selection** section.
- 3 From the **Selection** list, choose **Right Hole**.
- 4 Locate the **Force** section. Specify the \mathbf{f}_A vector as

0	x
0	y
8.5 [MPa]	z

Phase I

- 1 In the **Physics** toolbar, click  **Attributes** and choose **Phase**.
- 2 In the **Settings** window for **Phase**, locate the **Load Phase** section.
- 3 Specify the ϕ vector as

0	x
0	y
pi/2	z

Prescribed Displacement 2

- 1 In the **Physics** toolbar, click  **Boundaries** and choose **Prescribed Displacement**.
- 2 In the **Settings** window for **Prescribed Displacement**, locate the **Boundary Selection** section.
- 3 From the **Selection** list, choose **Left Hole**.
- 4 Locate the **Prescribed Displacement** section. From the **Displacement in y direction** list, choose **Prescribed**.

Boundary Load 2

- 1 In the **Physics** toolbar, click  **Boundaries** and choose **Boundary Load**.
- 2 In the **Settings** window for **Boundary Load**, locate the **Boundary Selection** section.
- 3 From the **Selection** list, choose **Left Hole**.
- 4 Locate the **Force** section. Specify the \mathbf{f}_A vector as

0.5 [MPa]	x
0	y
8.5 [MPa]	z

MESH 1

Free Quad 1

- 1 In the **Mesh** toolbar, click  **More Generators** and choose **Free Quad**.
- 2 Select Boundary 30 only.

Size 1

- 1 Right-click **Free Quad 1** and choose **Size**.
- 2 In the **Settings** window for **Size**, locate the **Element Size** section.
- 3 From the **Predefined** list, choose **Finer**.

Distribution 1

- 1 In the **Model Builder** window, right-click **Free Quad 1** and choose **Distribution**.
- 2 Select Edge 65 only.

Swept 1

- 1 In the **Mesh** toolbar, click  **Swept**.
- 2 In the **Settings** window for **Swept**, locate the **Domain Selection** section.
- 3 From the **Geometric entity level** list, choose **Domain**.

4 Select Domain 7 only.

Distribution 1

- 1 Right-click **Swept 1** and choose **Distribution**.
- 2 In the **Settings** window for **Distribution**, locate the **Distribution** section.
- 3 In the **Number of elements** text field, type 2.

Free Quad 2

- 1 In the **Mesh** toolbar, click  **More Generators** and choose **Free Quad**.
- 2 Select Boundaries 2 and 61 only.

Size 1

- 1 Right-click **Free Quad 2** and choose **Size**.
- 2 In the **Settings** window for **Size**, locate the **Element Size** section.
- 3 From the **Predefined** list, choose **Fine**.

Swept 2

- 1 In the **Mesh** toolbar, click  **Swept**.
- 2 In the **Settings** window for **Swept**, locate the **Domain Selection** section.
- 3 From the **Geometric entity level** list, choose **Domain**.
- 4 Select Domains 1, 2, and 4 only.

Distribution 1

- 1 Right-click **Swept 2** and choose **Distribution**.
- 2 In the **Settings** window for **Distribution**, locate the **Distribution** section.
- 3 In the **Number of elements** text field, type 2.

Copy Domain 1

- 1 In the **Model Builder** window, right-click **Mesh 1** and choose **Copying Operations > Copy Domain**.
- 2 Select Domains 1, 2, and 7 only.
- 3 In the **Settings** window for **Copy Domain**, locate the **Destination Domains** section.
- 4 Click to select the  **Activate Selection** toggle button.
- 5 Select Domains 5, 6, and 8 only.

Free Quad 3

- 1 In the **Mesh** toolbar, click  **More Generators** and choose **Free Quad**.
- 2 Select Boundary 10 only.

Swept 3

- 1 In the **Mesh** toolbar, click  **Swept**.
- 2 In the **Settings** window for **Swept**, click  **Build All**.

The complete mesh should look similar to that shown in the figure below.

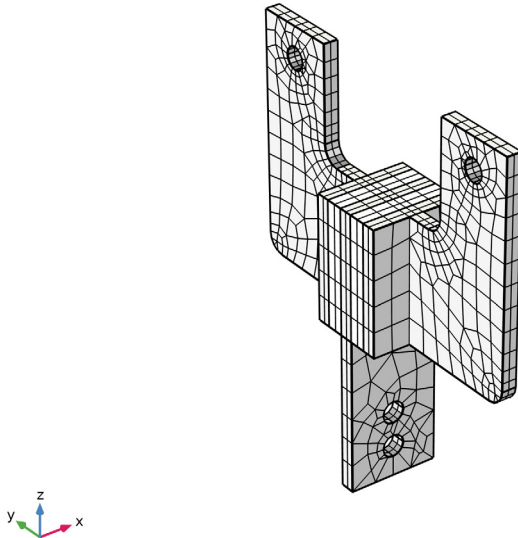

STUDY I

Step 1: Frequency Domain

- 1 In the **Model Builder** window, under **Study I** click **Step 1: Frequency Domain**.
- 2 In the **Settings** window for **Frequency Domain**, locate the **Study Settings** section.
- 3 In the **Frequencies** text field, type range (0,0.125,0.5) range (1,0.5,5).

Solution 1 (sol1)

In the **Study** toolbar, click  **Show Default Solver**.

RESULTS

Before computing the solution, set up a displacement plot that will be displayed and updated after every frequency response computation.

Displacement, Frequency Domain

- 1 In the **Results** toolbar, click  **3D Plot Group**.

- 2 In the **Settings** window for **3D Plot Group**, type **Displacement**, **Frequency Domain** in the **Label** text field.

Surface 1

- 1 Right-click **Displacement, Frequency Domain** and choose **Surface**.
- 2 In the **Settings** window for **Surface**, click **Replace Expression** in the upper-right corner of the **Expression** section. From the menu, choose **Component 1 (comp1) > Solid Mechanics > Displacement > Displacement field - m > w - Displacement field, Z-component**.
- 3 Locate the **Expression** section. From the **Unit** list, choose **mm**.
- 4 Locate the **Coloring and Style** section. From the **Color table** list, choose **SpectrumLight**.

Deformation 1

Right-click **Surface 1** and choose **Deformation**.

STUDY 1

Step 1: Frequency Domain

- 1 In the **Settings** window for **Frequency Domain**, click to expand the **Results While Solving** section.
- 2 Select the **Plot** checkbox.

Solution 1 (sol1)

In the **Model Builder** window, under **Study 1 > Solver Configurations** right-click **Solution 1 (sol1)** and choose **Run**.

RESULTS

Displacement, Frequency Domain

- 1 In the **Settings** window for **3D Plot Group**, locate the **Data** section.
- 2 From the **Parameter value (freq (Hz))** list, choose **3**.
- 3 Locate the **Color Legend** section. Select the **Show maximum and minimum values** checkbox.
- 4 In the **Displacement, Frequency Domain** toolbar, click  **Plot**.

The computed solution should closely resemble that shown in [Figure 2](#).

To plot the storage and loss moduli, follow these steps:

Cut Point 3D 1

- 1 In the **Results** toolbar, click  **Cut Point 3D**.
- 2 In the **Settings** window for **Cut Point 3D**, locate the **Point Data** section.

- 3 In the **X** text field, type 0.
- 4 In the **Z** text field, type 0.
- 5 In the **Y** text field, type -10.

Storage and Loss Moduli

- 1 In the **Results** toolbar, click  **ID Plot Group**.
- 2 In the **Settings** window for **ID Plot Group**, type Storage and Loss Moduli in the **Label** text field.
- 3 Locate the **Data** section. From the **Dataset** list, choose **Cut Point 3D I**.
- 4 Click to expand the **Title** section. From the **Title type** list, choose **Manual**.
- 5 In the **Title** text area, type Storage and loss moduli.
- 6 Locate the **Legend** section. From the **Position** list, choose **Upper left**.

Point Graph 1

- 1 Right-click **Storage and Loss Moduli** and choose **Point Graph**.
- 2 In the **Settings** window for **Point Graph**, locate the **y-Axis Data** section.
- 3 In the **Expression** text field, type $\text{solid.Gstor}/6.895$.
- 4 Click to expand the **Coloring and Style** section. From the **Width** list, choose **2**.
- 5 Click to expand the **Legends** section. Select the **Show legends** checkbox.
- 6 From the **Legends** list, choose **Manual**.
- 7 In the table, enter the following settings:

Legends
$\text{G}_{\text{stor}}/6.895$

Point Graph 2

- 1 In the **Model Builder** window, right-click **Storage and Loss Moduli** and choose **Point Graph**.
- 2 In the **Settings** window for **Point Graph**, locate the **y-Axis Data** section.
- 3 In the **Expression** text field, type $\text{solid.Gloss}/6.895$.
- 4 Click to expand the **Coloring and Style** section. Find the **Line style** subsection. From the **Line** list, choose **Dashed**.
- 5 From the **Width** list, choose **2**.
- 6 Locate the **Legends** section. Select the **Show legends** checkbox.
- 7 From the **Legends** list, choose **Manual**.

8 In the table, enter the following settings:



Legends

$G_{loss}/6.895$

9 In the **Storage and Loss Moduli** toolbar, click  **Plot**.

Add a new study to compute, using FFT, the solution representation in time domain for the excitation frequency of 3 Hz.

ADD STUDY

- 1 In the **Home** toolbar, click  **Add Study** to open the **Add Study** window.
- 2 Go to the **Add Study** window.
- 3 Find the **Studies** subsection. In the **Select Study** tree, select **Empty Study**.
- 4 Right-click and choose **Add Study**.
- 5 In the **Home** toolbar, click  **Add Study** to close the **Add Study** window.

STUDY 2

Step 1: Frequency to Time FFT

- 1 In the **Study** toolbar, click  **More Study Steps** and choose **Time Dependent > Frequency to Time FFT**.
- 2 In the **Settings** window for **Frequency to Time FFT**, locate the **Study Settings** section.
- 3 From the **Input study** list, choose **Study 1, Frequency Domain**.
- 4 In the **Times** text field, type $\text{range}(0, 1/(3*30), 1/3)$.
- 5 Select the **Use window function** checkbox.
- 6 From the **Window function** list, choose **Rectangular**.
- 7 In the **Window start** text field, type 2.9.
- 8 In the **Window end** text field, type 3.1.
- 9 From the **Scaling** list, choose **Discrete Fourier transform**.

DEFINITIONS

Set up a variable to compute the time domain equivalent of the total force applied to one of the mounting holes.

Variables 1

- 1 In the **Definitions** toolbar, click  **Local Variables**.
- 2 In the **Settings** window for **Variables**, locate the **Variables** section.

3 In the table, enter the following settings:

Name	Expression	Unit	Description
Fz1	$8.5[\text{MPa}] \cdot \cos(2 \cdot \pi \cdot t \cdot 3[\text{Hz}]) \cdot \pi \cdot 16[\text{mm}] \cdot 10[\text{mm}]$	N	Total force, Z component

4 In the **Home** toolbar, click  **Compute**.

RESULTS

Displacement, Time Domain

1 In the **Settings** window for **3D Plot Group**, locate the **Data** section.

2 From the **Time (s)** list, choose **0.33333**.

The default plot will show the stress at the last time moment. Change it to visualize the vertical displacement as shown in [Figure 4](#).

3 In the **Label** text field, type **Displacement, Time Domain**.

4 Locate the **Color Legend** section. Select the **Show maximum and minimum values** checkbox.

Volume 1

1 In the **Model Builder** window, expand the **Displacement, Time Domain** node, then click **Volume 1**.

2 In the **Settings** window for **Volume**, click **Replace Expression** in the upper-right corner of the **Expression** section. From the menu, choose **Component 1 (comp1) > Solid Mechanics > Displacement > Displacement field - m > w - Displacement field, Z-component**.

3 Locate the **Expression** section. From the **Unit** list, choose **mm**.

4 In the **Displacement, Time Domain** toolbar, click  **Plot**.

Hysteresis Loop

1 In the **Home** toolbar, click  **Add Plot Group** and choose **ID Plot Group**.

Plot the total vertical force versus vertical displacement for one of the mounting holes, [Figure 5](#).



2 In the **Settings** window for **ID Plot Group**, type **Hysteresis Loop** in the **Label** text field.

3 Locate the **Data** section. From the **Dataset** list, choose **Study 2/Solution 2 (sol2)**.

Point Graph 1

1 Right-click **Hysteresis Loop** and choose **Point Graph**.

2 In the **Settings** window for **Point Graph**, locate the **Selection** section.

- 3 Click to select the  **Activate Selection** toggle button.
- 4 Select Point 25 only.
- 5 Locate the **y-Axis Data** section. In the **Expression** text field, type Fz1.
- 6 From the **Unit** list, choose **kN**.
- 7 Locate the **x-Axis Data** section. From the **Parameter** list, choose **Expression**.
- 8 In the **Expression** text field, type w.
- 9 From the **Unit** list, choose **mm**.
- 10 Click to expand the **Title** section. From the **Title type** list, choose **Manual**.
- 11 In the **Title** text area, type Hysteresis loop.
- 12 In the **Hysteresis Loop** toolbar, click  **Plot**.