



Model created in COMSOL Multiphysics 6.4

# Eigenfrequency Analysis of a Free Cylinder

## *Introduction*

---

In the following example you compute the eigenfrequencies of a free circular pipe using four different approaches:

- An axisymmetric model using the Solid Mechanics interface.
- An axisymmetric model using the Shell interface.
- A sector of a 3D model using cyclic symmetry in the Solid Mechanics interface.
- A sector of a 3D model using cyclic symmetry in the Shell interface.

The example is taken from NAFEMS *Free Vibration Benchmarks* (Ref. 1). The eigenfrequencies are compared with the values given in the benchmark report.

As an extension, you will also compute eigenfrequencies with twisting deformation.

## *Model Definition*

---

The model is NAFEMS Test No 41, “Free Cylinder” described on page 41 in NAFEMS *Free Vibration Benchmarks*, vol. 3 (Ref. 1). The Benchmark tests the capability to handle rigid body modes and eigenfrequencies.

The cylinder is 10 m tall with an inner radius of 1.8 m and a thickness of 0.4 m.

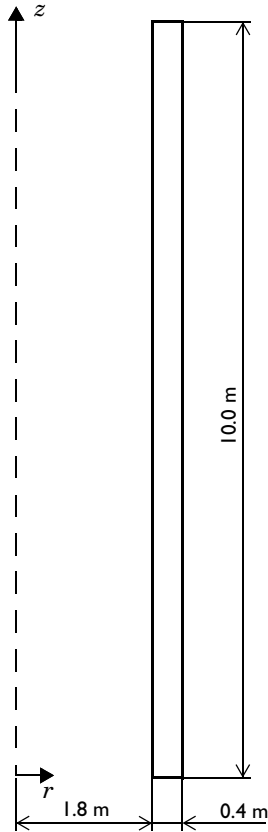

*Figure 1: Model geometry in the  $rz$ -plane.*

In the axisymmetric solid model, the geometry consists of this rectangle.

In the axisymmetric shell interface, the mesh is placed on the line representing the inner boundary of the cylinder, and an offset property is used in order to account for the fact that the shell model should represent the midsurface.

In the 3D solid model, the rectangle is swept around the axis of revolution, so that a  $15^\circ$  sector is formed. As long as  $360^\circ$  is an exact multiple of the sector angle, any angle could have been used.

#### **MATERIAL**

The material is isotropic linear elastic with  $E = 2.0 \cdot 10^{11}$  Pa,  $\nu = 0.3$ , and  $\rho = 8000$  kg/m<sup>3</sup>.

## LOADS

In an eigenfrequency analysis loads are not needed.

## CONSTRAINTS

In the axisymmetric models, no constraints are applied because the cylinder is free. In the 3D model, cyclic symmetry constraints are applied to the cuts in the azimuthal direction.

## Results

---

For structural mechanics, there are two possible interpretations of axisymmetry. The most common one is that there are no displacements out of the  $RZ$ -plane. Another interpretation, which also allows twisting motion, is that all derivatives of the displacements with respect to the azimuthal coordinate is zero. Such an extension is available when using the Solid Mechanics interface.

The original NAFEMS example does not contain out-of-plane displacements, in which case there is one rigid body mode. The rigid body mode with an eigenvalue close to zero is found in all physics interfaces. The corresponding shape is a pure axial rigid body translation without any radial displacement. The eigenfrequencies are in close agreement with the target values from the NAFEMS Free Vibration Benchmarks (Ref. 1); see below.

EIGENFREQUENCY	SOLID MECHANICS, AXISYMMETRY	SHELL, AXISYMMETRY	SOLID MECHANICS, 3D	SHELL, 3D	TARGET (Ref. 1)
$f_2$	243.50	243.64	243.50	243.64	243.53
$f_3$	377.39	378.16	377.39	378.17	377.41
$f_4$	394.21	394.11	394.22	394.11	394.11
$f_5$	397.84	397.36	397.84	397.37	397.72
$f_6$	405.36	407.43	405.36	407.46	405.28

The analytical solution for twisting vibration of a free cylindrical pipe is

$$f_n = \frac{n}{2L} \sqrt{\frac{G}{\rho}} \quad (1)$$

Here,  $G$  is the shear modulus,

$$G = \frac{E}{2(1 + \nu)} \quad (2)$$

In this case, there is one more rigid body mode: pure rotation around the axis of revolution. The computed nontrivial eigenfrequencies have a very good agreement with the analytical solution:

EIGENFREQUENCY	SOLID MECHANICS, AXISYMMETRY	SOLID MECHANICS, 3D	TARGET (ANALYTICAL)
$f_1$	155.04	155.04	155.04
$f_2$	310.09	310.09	310.09

Figure 2 shows the shape of the second eigenmode in the axisymmetric solid model. In Figure 3, the same plot is shown for the axisymmetric shell interface. In both cases, Revolution 2D datasets have been used for extending the axisymmetric model into 3D space.

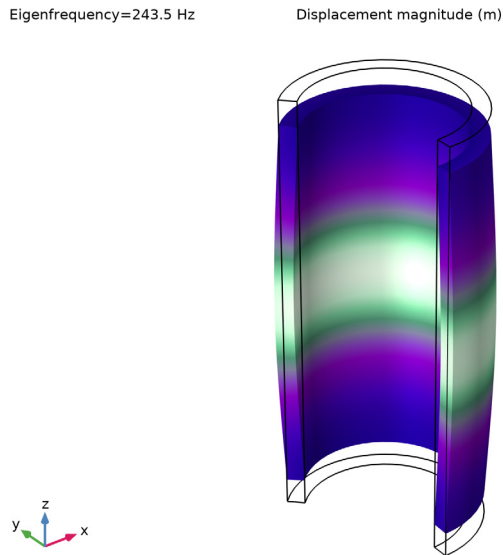
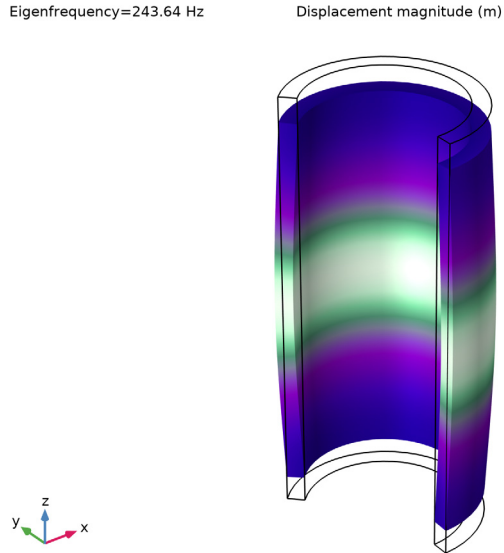

Figure 2: The second nonrigid eigenmode, computed using an axisymmetric solid mechanics interface.

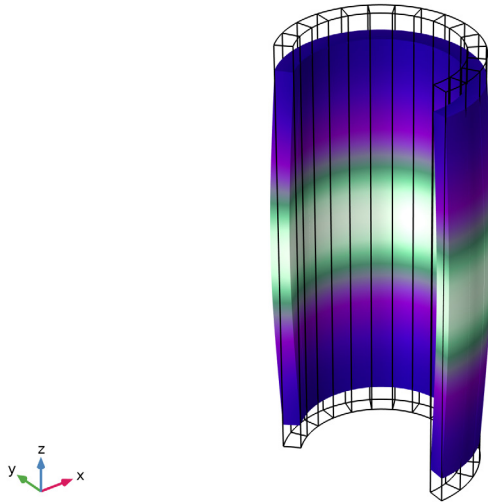

*Figure 3: The second nonrigid eigenmode, computed using an axisymmetric shell interface. Due to the offset property, the shell is modeled at the true midsurface, even though the mesh is at the inner boundary of the cylinder.*

In [Figure 4](#) and [Figure 5](#), two eigenmodes from the 3D solid model are shown. A Sector 3D dataset has been used for expanding the results from the original 15° sector.

Eigenfrequency=243.5 Hz

Displacement magnitude (m)



*Figure 4: The second nonrigid eigenmode, computed using a 3D solid mechanics interface with cyclic symmetry boundary conditions.*

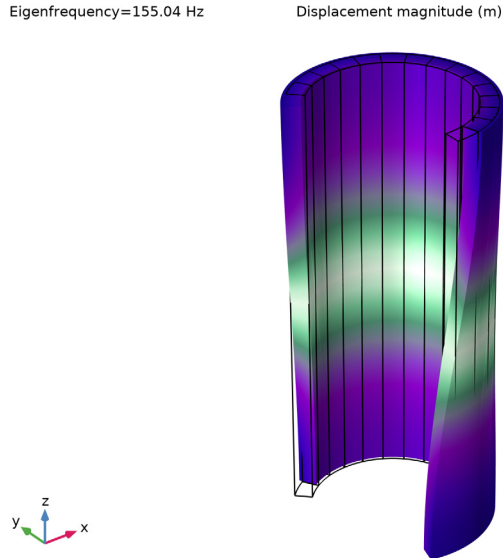

*Figure 5: The first nonrigid eigenmode, computed using a 3D solid mechanics interface with cyclic symmetry boundary conditions.*

### *Notes About the COMSOL Implementation*

---

In the 3D model, you could have used ordinary **Symmetry** boundary conditions instead of the **Periodic Condition**. The effect would have been that only the in-plane modes were computed.

In a real pipe, there are however also other eigenmodes, which are not axially symmetric. You can find such modes by using azimuthal mode numbers other than zero in the settings for the cyclic symmetry condition (3D) and Solid Mechanics interface settings (2D axisymmetry). Such modes can be visualized by setting the azimuthal mode number to the corresponding value in the **Advanced** section in the settings for the **Revolution 2D** and **Sector 3D** datasets.

### *Reference*

---

I. F. Abassian, D.J. Dawswell, and N.C. Knowles, *Free Vibration Benchmarks*, NAFEMS, Glasgow, 1987.

---

**Application Library path:** Structural\_Mechanics\_Module/  
Verification\_Examples/free\_cylinder

---

### *Modeling Instructions*



---

From the **File** menu, choose **New**.

#### **NEW**

In the **New** window, click  **Model Wizard**.

#### **MODEL WIZARD**

- 1 In the **Model Wizard** window, click  **2D Axisymmetric**.
- 2 In the **Select Physics** tree, select **Structural Mechanics > Solid Mechanics (solid)**.
- 3 Click **Add**.
- 4 Click  **Study**.
- 5 In the **Select Study** tree, select **General Studies > Eigenfrequency**.
- 6 Click  **Done**.

#### **GLOBAL DEFINITIONS**

##### *Parameters 1*



- 1 In the **Model Builder** window, under **Global Definitions** click **Parameters 1**.
- 2 In the **Settings** window for **Parameters**, locate the **Parameters** section.
- 3 In the table, enter the following settings:

Name	Expression	Value	Description
height	10[m]	10 m	Height of cylinder
thic	0.4[m]	0.4 m	Thickness of cylinder
r_in	1.8[m]	1.8 m	Inner radius
theta	15[deg]	0.2618 rad	Sector angle

#### **GEOMETRY 1**

##### *Rectangle 1 (r1)*

- 1 In the **Geometry** toolbar, click  **Rectangle**.

- 2 In the **Settings** window for **Rectangle**, locate the **Size and Shape** section.
- 3 In the **Width** text field, type `thic`.
- 4 In the **Height** text field, type `height`.
- 5 Locate the **Position** section. In the **r** text field, type `r_in`.
- 6 Click  **Build All Objects**.
- 7 Click the  **Zoom Extents** button in the **Graphics** toolbar.

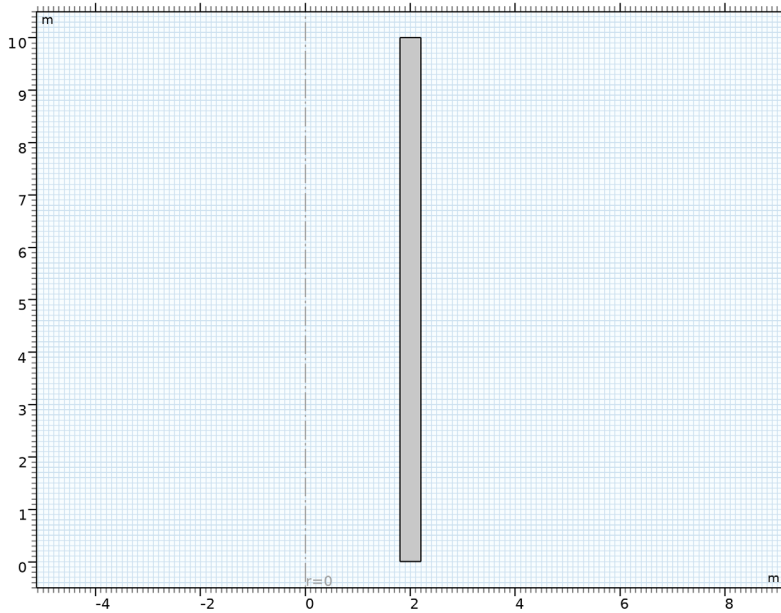

## GLOBAL DEFINITIONS

In this example, the same material data will be referenced from several physics interfaces, so it is convenient to define a global material.

### *Material 1 (mat1)*

- 1 In the **Model Builder** window, under **Global Definitions** right-click **Materials** and choose **Blank Material**.
- 2 In the **Settings** window for **Material**, click to expand the **Material Properties** section.
- 3 In the **Material properties** tree, select **Basic Properties > Density**.
- 4 Click  **Add to Material**.
- 5 In the **Material properties** tree, select **Solid Mechanics > Linear Elastic Material > Young's Modulus and Poisson's Ratio**.

6 Click  **Add to Material**.

7 Locate the **Material Contents** section. In the table, enter the following settings:

Property	Variable	Value	Unit	Property group
Density	rho	8000	kg/m <sup>3</sup>	Basic
Young's modulus	E	2e11	Pa	Young's modulus and Poisson's ratio
Poisson's ratio	nu	0.3	I	Young's modulus and Poisson's ratio

## MATERIALS

### *Material Link 1 (matlnk1)*

In the **Model Builder** window, under **Component 1 (comp1)** right-click **Materials** and choose **More Materials > Material Link**.

## MESH 1

### *Mapped 1*

In the **Mesh** toolbar, click  **Mapped**.

### *Distribution 1*

1 In the **Model Builder** window, right-click **Mapped 1** and choose **Distribution**.

2 In the **Settings** window for **Distribution**, locate the **Distribution** section.

3 In the **Number of elements** text field, type 20.

4 Select Boundary 1 only.

### *Distribution 2*

1 In the **Model Builder** window, right-click **Mapped 1** and choose **Distribution**.

2 In the **Settings** window for **Distribution**, locate the **Distribution** section.

3 In the **Number of elements** text field, type 2.

4 Select Boundary 2 only.

5 Click  **Build All**.

## STUDY 1, 2D AXISYMMETRIC SOLID

1 In the **Model Builder** window, click **Study 1**.

2 In the **Settings** window for **Study**, type Study 1, 2D Axisymmetric Solid in the **Label** text field.



3 In the **Study** toolbar, click  **Compute**.

## RESULTS

*Mode Shape (solid)*

Visualize an eigenmode in 3D.



*Mode Shape, 3D (solid)*

- 1 In the **Model Builder** window, click **Mode Shape, 3D (solid)**.
- 2 In the **Settings** window for **3D Plot Group**, locate the **Data** section.
- 3 From the **Eigenfrequency (Hz)** list, choose **243.5**.
- 4 Click the  **Show Grid** button in the **Graphics** toolbar.
- 5 In the **Mode Shape, 3D (solid)** toolbar, click  **Plot**.
- 6 Click the  **Zoom Extents** button in the **Graphics** toolbar.

## COMPONENT 1 (COMP1)

Add a 2D axisymmetry **Shell** interface with the same data, and compute the eigenfrequencies.

## ADD PHYSICS

- 1 In the **Home** toolbar, click  **Add Physics** to open the **Add Physics** window.
- 2 Go to the **Add Physics** window.
- 3 In the tree, select **Structural Mechanics > Shell (shell)**.
- 4 Click the **Add to Component 1** button in the window toolbar.
- 5 In the **Home** toolbar, click  **Add Physics** to close the **Add Physics** window.

## SHELL (SHELL)

Select Boundary 1 only.

*Thickness and Offset 1*

Since the inner boundary of the cylinder is used as geometry for the shell interface, and shell normal is pointing inward, set top surface of shell on the boundary.



- 1 In the **Model Builder** window, under **Component 1 (comp1) > Shell (shell)** click **Thickness and Offset 1**.
- 2 In the **Settings** window for **Thickness and Offset**, locate the **Thickness and Offset** section.
- 3 In the  $d_0$  text field, type `thic`.
- 4 From the **Position** list, choose **Top surface on boundary**.

## MATERIALS

### *Material Link 2 (matlnk2)*

- 1 In the **Model Builder** window, under **Component 1 (comp1)** right-click **Materials** and choose **More Materials > Material Link**.
- 2 In the **Settings** window for **Material Link**, locate the **Geometric Entity Selection** section.
- 3 From the **Geometric entity level** list, choose **Boundary**.
- 4 Select Boundary 1 only.

## ADD STUDY



- 1 In the **Home** toolbar, click  **Add Study** to open the **Add Study** window.
- 2 Go to the **Add Study** window.
- 3 Find the **Studies** subsection. In the **Select Study** tree, select **General Studies > Eigenfrequency**.
- 4 Find the **Physics interfaces in study** subsection. In the table, clear the **Solve** checkbox for **Solid Mechanics (solid)**.
- 5 Click the **Add Study** button in the window toolbar.
- 6 In the **Home** toolbar, click  **Add Study** to close the **Add Study** window.

## STUDY 2, 2D AXISYMMETRIC SHELL

- 1 In the **Settings** window for **Study**, type Study 2, 2D Axisymmetric Shell in the **Label** text field.
- 2 In the **Study** toolbar, click  **Compute**.

## RESULTS

### *Mode Shape, 3D (shell)*

- 1 In the **Model Builder** window, under **Results** click **Mode Shape, 3D (shell)**.
- 2 In the **Settings** window for **3D Plot Group**, locate the **Data** section.
- 3 From the **Eigenfrequency (Hz)** list, choose **243.64**.
- 4 Click the  **Show Grid** button in the **Graphics** toolbar.
- 5 In the **Mode Shape, 3D (shell)** toolbar, click  **Plot**.

## ROOT

Now, add a 3D solid sector with cyclic symmetry boundary conditions and compute the eigenfrequencies.

## ADD COMPONENT

In the **Model Builder** window, right-click the root node and choose **Add Component > 3D**.

## GEOMETRY 2

*Work Plane 1 (wp1)*

- 1 In the **Geometry** toolbar, click  **Work Plane**.
- 2 In the **Settings** window for **Work Plane**, locate the **Plane Definition** section.
- 3 From the **Plane** list, choose **xz-plane**.

## GEOMETRY 1

*Rectangle 1 (r1)*

In the **Model Builder** window, under **Component 1 (comp1) > Geometry 1** right-click **Rectangle 1 (r1)** and choose **Copy**.

## GEOMETRY 2

*Work Plane 1 (wp1) > Plane Geometry*

In the **Model Builder** window, under **Component 2 (comp2) > Geometry 2 > Work Plane 1 (wp1)** click **Plane Geometry**.



*Work Plane 1 (wp1) > Rectangle 1 (r1)*

Right-click **Plane Geometry** and choose **Paste Rectangle**.

*Revolve 1 (rev1)*



- 1 In the **Model Builder** window, under **Component 2 (comp2) > Geometry 2** right-click **Work Plane 1 (wp1)** and choose **Revolve**.
- 2 In the **Settings** window for **Revolve**, locate the **Revolution Angles** section.
- 3 Click the **Angles** button.
- 4 In the **End angle** text field, type theta.
- 5 Click  **Build All Objects**.

## ADD PHYSICS

- 1 In the **Home** toolbar, click  **Add Physics** to open the **Add Physics** window.
- 2 Go to the **Add Physics** window.
- 3 In the tree, select **Structural Mechanics > Solid Mechanics (solid)**.
- 4 Click the **Add to Component 2** button in the window toolbar.
- 5 In the **Home** toolbar, click  **Add Physics** to close the **Add Physics** window.

## SOLID MECHANICS 2 (SOLID2)

### *Periodic Condition 1*

- 1 In the **Physics** toolbar, click  **Boundaries** and choose **Periodic Condition**.
- 2 Select Boundaries 2 and 5 only.
- 3 In the **Settings** window for **Periodic Condition**, locate the **Periodicity Settings** section.
- 4 From the **Type of periodicity** list, choose **Cyclic symmetry**.
- 5 Right-click **Periodic Condition 1** and choose **Manual Destination Selection**.
- 6 Locate the **Destination Selection** section. Click to select the  **Activate Selection** toggle button.
- 7 Select Boundary 2 only.

## MESH 2

### *Mapped 1*

- 1 In the **Mesh** toolbar, click  **More Generators** and choose **Mapped**.
- 2 Select Boundary 3 only.

### *Distribution 1*

- 1 Right-click **Mapped 1** and choose **Distribution**.
- 2 In the **Settings** window for **Distribution**, locate the **Distribution** section.
- 3 In the **Number of elements** text field, type 2.
- 4 Select Edges 2 and 7 only.

### *Mapped 1*

In the **Model Builder** window, right-click **Mapped 1** and choose **Build Selected**.

### *Swept 1*

In the **Mesh** toolbar, click  **Swept**.

### *Distribution 1*



- 1 Right-click **Swept 1** and choose **Distribution**.
- 2 In the **Settings** window for **Distribution**, locate the **Distribution** section.
- 3 In the **Number of elements** text field, type 20.
- 4 Click  **Build All**.

## MATERIALS

### *Material Link 3 (matlnk3)*

In the **Model Builder** window, under **Component 2 (comp2)** right-click **Materials** and choose **More Materials > Material Link**.

## ADD STUDY

- 1 In the **Home** toolbar, click  **Add Study** to open the **Add Study** window.
- 2 Go to the **Add Study** window.
- 3 Find the **Studies** subsection. In the **Select Study** tree, select **General Studies > Eigenfrequency**.
- 4 Find the **Physics interfaces in study** subsection. In the table, clear the **Solve** checkboxes for **Solid Mechanics (solid)** and **Shell (shell)**.
- 5 Click the **Add Study** button in the window toolbar.
- 6 In the **Home** toolbar, click  **Add Study** to close the **Add Study** window.

## STUDY 3, 3D SOLID SECTOR

In the **Settings** window for **Study**, type Study 3, 3D Solid Sector in the **Label** text field.

### *Step 1: Eigenfrequency*



- 1 In the **Model Builder** window, under **Study 3, 3D Solid Sector** click **Step 1: Eigenfrequency**.
- 2 In the **Settings** window for **Eigenfrequency**, locate the **Study Settings** section.
- 3 Select the **Desired number of eigenfrequencies** checkbox. In the associated text field, type 10.
- 4 In the **Model Builder** window, collapse the **Study 3, 3D Solid Sector** node.
- 5 In the **Study** toolbar, click  **Compute**.

## RESULTS

### *Sector 3D*

- 1 In the **Model Builder** window, expand the **Results > Datasets** node, then click **Sector 3D**.
- 2 In the **Settings** window for **Sector 3D**, locate the **Symmetry** section.
- 3 From the **Sectors to include** list, choose **Manual**.
- 4 In the **Start sector** text field, type 18.
- 5 In the **Number of sectors to include** text field, type 15.

### *Mode Shape, Full Geometry (solid2)*

- 1 In the **Model Builder** window, under **Results** click **Mode Shape, Full Geometry (solid2)**.
- 2 In the **Settings** window for **3D Plot Group**, locate the **Data** section.
- 3 From the **Eigenfrequency (Hz)** list, choose **243.5**.
- 4 In the **Mode Shape, Full Geometry (solid2)** toolbar, click  **Plot**.
- 5 Click the  **Show Grid** button in the **Graphics** toolbar.



Also twisting modes can be displayed.

- 6 From the **Eigenfrequency (Hz)** list, choose **155.04**.
- 7 In the **Mode Shape, Full Geometry (solid2)** toolbar, click  **Plot**.

### **COMPONENT 2 (COMP2)**

Add a 3D **Shell** interface with cyclic symmetry and same data, and compute the eigenfrequencies.

#### **ADD PHYSICS**

- 1 In the **Home** toolbar, click  **Add Physics** to open the **Add Physics** window.
- 2 Go to the **Add Physics** window.
- 3 In the tree, select **Structural Mechanics > Shell (shell)**.
- 4 Click the **Add to Component 2** button in the window toolbar.
- 5 In the **Home** toolbar, click  **Add Physics** to close the **Add Physics** window.

### **SHELL 2 (SHELL2)**

- 1 In the **Settings** window for **Shell**, locate the **Boundary Selection** section.
- 2 Click  **Clear Selection**.
- 3 Select Boundary 1 only.

#### *Linear Elastic Material 1*

In the **Model Builder** window, collapse the **Component 2 (comp2) > Shell 2 (shell2) > Linear Elastic Material 1** node.

#### *Thickness and Offset 1*

- 1 In the **Model Builder** window, click **Thickness and Offset 1**.
- 2 In the **Settings** window for **Thickness and Offset**, locate the **Thickness and Offset** section.
- 3 In the  $d_0$  text field, type `thic`.

4 From the **Position** list, choose **Top surface on boundary**.

To enforce cyclic symmetry boundary conditions in shell interface a cylindrical coordinate system is needed to get proper orientation of the source.

## DEFINITIONS (COMP2)

*Cylindrical System 3 (sys3)*

In the **Definitions** toolbar, click  **Coordinate Systems** and choose **Cylindrical System**.

## SHELL 2 (SHELL2)

*Periodic Condition 1*

1 In the **Physics** toolbar, click  **Edges** and choose **Periodic Condition**.

2 Select Edges 1 and 6 only.

3 In the **Settings** window for **Periodic Condition**, locate the **Periodicity Settings** section.

4 From the **Type of periodicity** list, choose **Cyclic symmetry**.

5 In the  $\theta_S$  text field, type theta.

6 Right-click **Periodic Condition 1** and choose **Manual Destination Selection**.

7 Locate the **Destination Selection** section. Click to select the  **Activate Selection** toggle button.

8 Select Edge 1 only.

9 Click to expand the **Orientation of Source** section. From the **Transform to intermediate map** list, choose **Cylindrical System 3 (sys3)**.

10 Click to expand the **Orientation of Destination** section. From the **Transform to intermediate map** list, choose **Cylindrical System 3 (sys3)**.

## MATERIALS

*Material Link 4 (matlnk4)*

1 In the **Model Builder** window, under **Component 2 (comp2)** right-click **Materials** and choose **More Materials > Material Link**.

2 In the **Settings** window for **Material Link**, locate the **Geometric Entity Selection** section.

3 From the **Geometric entity level** list, choose **Boundary**.

4 Select Boundary 1 only.

## ADD STUDY

1 In the **Home** toolbar, click  **Add Study** to open the **Add Study** window.

- 2 Go to the **Add Study** window.
- 3 Find the **Studies** subsection. In the **Select Study** tree, select **General Studies > Eigenfrequency**.
- 4 Find the **Physics interfaces in study** subsection. In the table, clear the **Solve** checkboxes for **Solid Mechanics (solid)**, **Shell (shell)**, and **Solid Mechanics 2 (solid2)**.
- 5 Click the **Add Study** button in the window toolbar.
- 6 In the **Home** toolbar, click  **Add Study** to close the **Add Study** window.

#### **STUDY 4, 3D SHELL SECTOR**

In the **Settings** window for **Study**, type Study 4, 3D Shell Sector in the **Label** text field.

##### *Step 1: Eigenfrequency*



- 1 In the **Model Builder** window, under **Study 4, 3D Shell Sector** click **Step 1: Eigenfrequency**.
- 2 In the **Settings** window for **Eigenfrequency**, locate the **Study Settings** section.
- 3 Select the **Desired number of eigenfrequencies** checkbox. In the associated text field, type 10.
- 4 In the **Model Builder** window, collapse the **Study 4, 3D Shell Sector** node.
- 5 In the **Study** toolbar, click  **Compute**.

#### **RESULTS**

##### *Sector 3D 2*

- 1 In the **Model Builder** window, under **Results > Datasets** click **Sector 3D 2**.
- 2 In the **Settings** window for **Sector 3D**, locate the **Symmetry** section.
- 3 From the **Sectors to include** list, choose **Manual**.
- 4 In the **Start sector** text field, type 18.
- 5 In the **Number of sectors to include** text field, type 15.

##### *Mode Shape, Full Geometry (shell2)*

- 1 In the **Model Builder** window, under **Results** click **Mode Shape, Full Geometry (shell2)**.
- 2 In the **Settings** window for **3D Plot Group**, locate the **Data** section.
- 3 From the **Eigenfrequency (Hz)** list, choose **243.64**.
- 4 In the **Mode Shape, Full Geometry (shell2)** toolbar, click  **Plot**.
- 5 Click the  **Show Grid** button in the **Graphics** toolbar.  
Also twisting modes can be displayed.
- 6 From the **Eigenfrequency (Hz)** list, choose **155.81**.

7 In the **Mode Shape, Full Geometry (shell2)** toolbar, click  **Plot**.

### **SOLID MECHANICS (SOLID)**

The twisting modes can also be computed using the axisymmetric **Solid Mechanics** and **Shell** interfaces. To do that, use circumferential mode extension.

- 1 In the **Model Builder** window, under **Component 1 (comp1)** click **Solid Mechanics (solid)**.
- 2 In the **Settings** window for **Solid Mechanics**, locate the **Axial Symmetry Approximation** section.
- 3 Find the **Time-harmonic** subsection. Select the **Circumferential mode extension** checkbox.

### **STUDY 1, 2D AXISYMMETRIC SOLID**



#### *Step 1: Eigenfrequency*

- 1 In the **Model Builder** window, under **Study 1, 2D Axisymmetric Solid** click **Step 1: Eigenfrequency**.
- 2 In the **Settings** window for **Eigenfrequency**, locate the **Physics and Variables Selection** section.
- 3 In the **Solve for** column of the table, under **Component 1 (comp1)**, clear the checkbox for **Shell (shell)**.
- 4 In the **Solve for** column of the table, under **Component 2 (comp2)**, clear the checkboxes for **Solid Mechanics 2 (solid2)** and **Shell 2 (shell2)**.
- 5 Locate the **Study Settings** section.
- 6 Select the **Desired number of eigenfrequencies** checkbox. In the associated text field, type 10.
- 7 In the **Study** toolbar, click  **Compute**.

### **RESULTS**

#### *Mode Shape, 3D (solid)*

Display the first twist mode.

- 1 In the **Model Builder** window, under **Results** click **Mode Shape, 3D (solid)**.
- 2 In the **Settings** window for **3D Plot Group**, locate the **Data** section.
- 3 From the **Eigenfrequency (Hz)** list, choose **155.04**.
- 4 In the **Mode Shape, 3D (solid)** toolbar, click  **Plot**.
- 5 From the **Eigenfrequency (Hz)** list, choose **243.5**.
- 6 In the **Mode Shape, 3D (solid)** toolbar, click  **Plot**.

## SHELL (SHELL)

- 1 In the **Model Builder** window, under **Component 1 (comp1)** click **Shell (shell)**.
- 2 In the **Settings** window for **Shell**, locate the **Axial Symmetry Approximation** section.
- 3 Find the **Time-harmonic** subsection. Select the **Circumferential mode extension** checkbox.

## STUDY 2, 2D AXISYMMETRIC SHELL



### *Step 1: Eigenfrequency*

- 1 In the **Model Builder** window, under **Study 2, 2D Axisymmetric Shell** click **Step 1: Eigenfrequency**.
- 2 In the **Settings** window for **Eigenfrequency**, locate the **Physics and Variables Selection** section.
- 3 In the **Solve for** column of the table, under **Component 2 (comp2)**, clear the checkboxes for **Solid Mechanics 2 (solid2)** and **Shell 2 (shell2)**.
- 4 Locate the **Study Settings** section.
- 5 Select the **Desired number of eigenfrequencies** checkbox. In the associated text field, type 10.
- 6 In the **Study** toolbar, click  **Compute**.

## RESULTS

### *Mode Shape, 3D (shell)*

Display the first twist mode.

- 1 In the **Model Builder** window, under **Results** click **Mode Shape, 3D (shell)**.
- 2 In the **Settings** window for **3D Plot Group**, locate the **Data** section.
- 3 From the **Eigenfrequency (Hz)** list, choose **155.81**.
- 4 In the **Mode Shape, 3D (shell)** toolbar, click  **Plot**.
- 5 From the **Eigenfrequency (Hz)** list, choose **243.64**.
- 6 In the **Mode Shape, 3D (shell)** toolbar, click  **Plot**.

## STUDY 3, 3D SOLID SECTOR

### *Step 1: Eigenfrequency*

- 1 In the **Model Builder** window, expand the **Study 3, 3D Solid Sector** node, then click **Step 1: Eigenfrequency**.
- 2 In the **Settings** window for **Eigenfrequency**, locate the **Physics and Variables Selection** section.

- 3 In the **Solve for** column of the table, under **Component 2 (comp2)**, clear the checkbox for **Shell 2 (shell2)**.