



Model created in COMSOL Multiphysics 6.4

# Bracket – Topology Optimization

## *Introduction*

---

Topology optimization in a structural mechanics context can answer the question: Given that you know the loads on the structure, which distribution of the available material maximizes stiffness? Or, conversely, how much material is necessary to obtain a predefined stiffness, and how should it be distributed? Such investigations typically occur during the concept design stages.

The conflicting goals of stiffness maximization and mass minimization lead to a continuum of possible optimal solutions, depending on how you balance the goals against each other.

This topology optimization example demonstrates how to use a penalization method (SIMP) to obtain an optimal distribution of a fixed amount of material such that stiffness is maximized. Changing the amount of material available leads to a different solution that is also Pareto optimal, representing a different balance between the conflicting objectives.

The various examples based on a bracket geometry form a suite of tutorials which summarizes the fundamentals when modeling structural mechanics problems in COMSOL Multiphysics and the Structural Mechanics Module. This example also requires the Optimization Module.

## *Model Definition*

---

The model shows how to determine the optimal material distribution in a bracket geometry. The bracket is symmetric about the plane  $x = 0$  and is made of a linear elastic material, structural steel.

It is optimized in two load configurations: First a single load case, which gives rise to an asymmetric design with two poorly connected halves. In a second analysis, two load cases are used, but this actually corresponds to four load cases, because symmetry is imposed. This results in a design with a stronger connection between the two halves.

The original geometry, which can be considered as the design space, is imported as a geometry sequence ([Figure 1](#)).

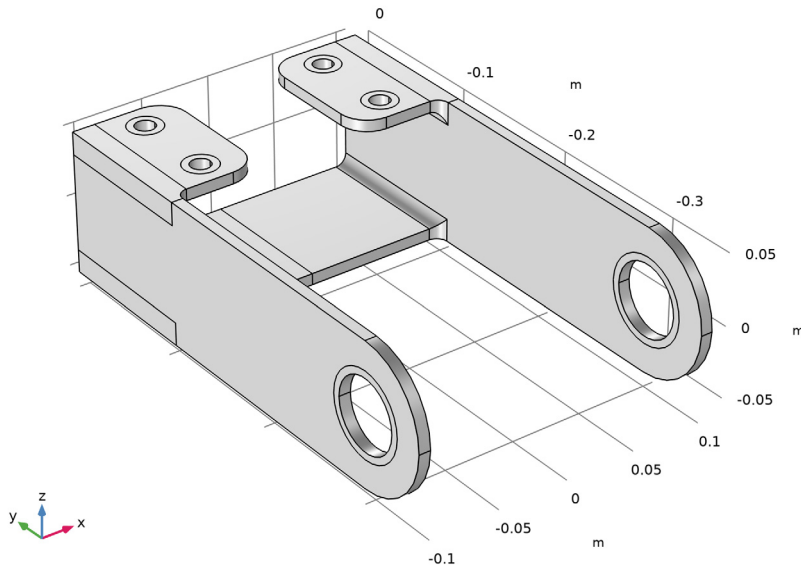

*Figure 1: The computational domain of the bracket is partitioned, so that the circles around the holes can be excluded from the design space.*

The optimality criterion is defined by the objective function, which is chosen to be the total strain energy in this example. Note that the strain energy exactly balances the work done by the applied load, so minimizing the strain energy minimizes the displacement induced at the points where loads are applied, effectively minimizing the compliance of the structure — maximizing its stiffness. The other, conflicting, objective is minimization of total mass, which is implemented as an upper bound on the mass of the optimized structure.

To regularize the problem we introduce a minimum length scale via a filter radius in a Helmholtz filter. See the *Topology Optimization of an MBB Beam* example in the Optimization Module Application Library for illustrations of this process. Ideally, the topology of the resulting designs should be mesh independent and for designs with moderate complexity this can be achieved. If the optimal design is very complex, other designs with slightly different topologies perform only marginally worse, so the optimization problem has many local minima, and it is likely that a slightly suboptimal design is identified. To reduce the probability of this happening, the model is solved using continuation in the SIMP exponent and the projection slope, that is, a sequence of

optimization problems are solved. One optimization result is thus used as the initial guess of the next. This is achieved by combining a **Parametric Sweep** and an **Optimization** study step.

## Results

---

The result of the optimization with one load case is shown in [Figure 2](#).

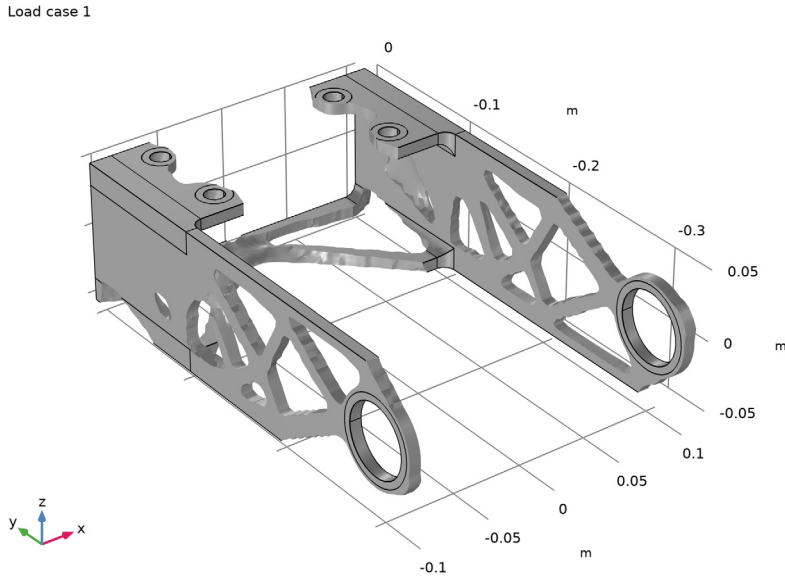

*Figure 2: A filtered volume plot, colored with the displacement magnitude. Only a single load case is considered, so the design becomes asymmetric and the two halves are poorly connected.*

When two cases are considered and symmetry is imposed, the optimization instead results in the design displayed in [Figure 3](#).

Load case 2

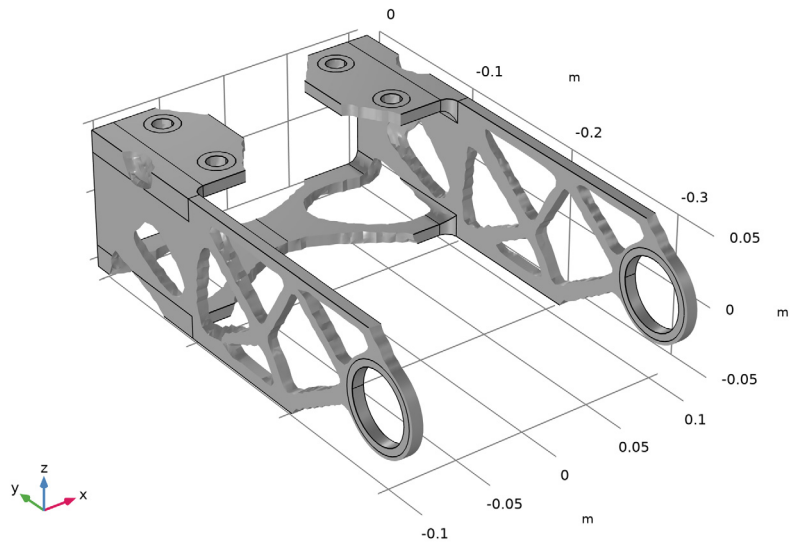

*Figure 3: When two cases are considered and symmetry is imposed, the connection between the two halves is stronger when compared to the single load case.*

The following plot shows the displacement field for the optimized solution after the geometry has been transferred to another component via a **Filter** dataset.

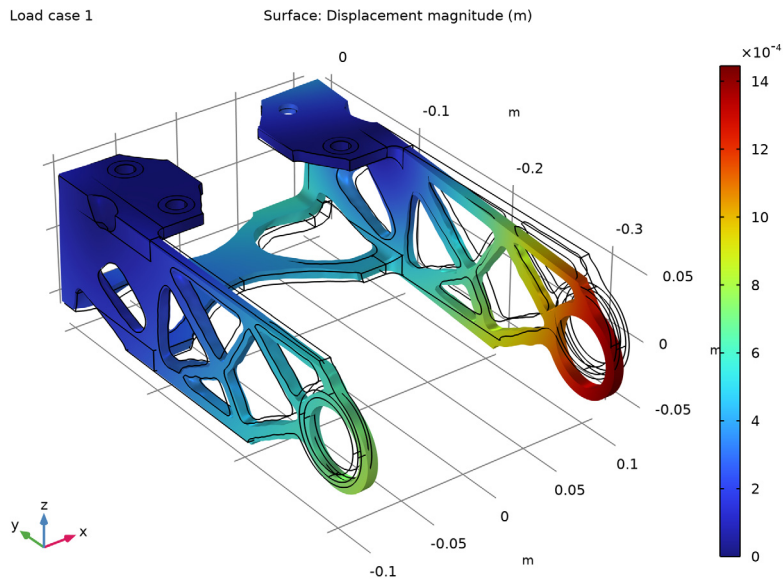

*Figure 4: The displacement field for the optimized design after it has been transferred to another component using a Filter dataset, a mesh part, and an Import geometry feature. The hole furthest away from the camera is unconstrained for Load case 1.*

### Notes About the COMSOL Implementation

---

This example demonstrates a strategy based on using the MMA solver with a limited number of iterations. The filtered variable is solved on a finer mesh to get a smooth design for postprocessing.

Continuation is used in the SIMP exponent as well as the projection slope. This is achieved with a **Parametric Sweep**, where the option **Reuse solution from previous step** has been enabled.

This model demonstrates how to export all domains together. This simplifies the import, but the curved boundaries will be described with flat triangles, so the hole geometry will be affected in this process, which might affect a contact analysis.

The control variable field, Helmholtz filter and SIMP penalization are defined through the use of a **Density Model** feature, while the design free restricted is restricted using the **Mirror Symmetry** feature. A Solid Mechanics interface represents the structural properties of the

bracket, while the objective and the constraints are defined directly in the **Topology Optimization** study step. The elastic strain energy density is a predefined variable, `solid.Ws`, available to use as the objective function for the optimization problem.

In this example the solver settings are changed slightly from their default values, in order to speed up the solution:

- Since the solid mechanics problem is linear, it is enough to use one pass through the segregated solver, so it is set to terminate after one iteration, rather than on a tolerance.
- When the constraints are changed, the structure of the stiffness matrix will change. For this reason, the caching of sparsity patterns is switched off.
- The GMRES solver is used rather than the MUMPS solver, because it is faster.

Finally, it is worth noting that the problem of finding a stiff design can be quite different from finding a design that does not fail, and it is generally advised to use shape or parameter optimization to ensure that the design is free of excessive stress concentrations.

## References

---

1. B.S. Lazarov and O. Sigmund, “Filters in topology optimization based on Helmholtz-type differential equations,” *International Journal for Numerical Methods in Engineering*, vol. 86, pp. 765–781, 2011.
2. F. Wang, B.S. Lazarov, and O. Sigmund, “On projection methods, convergence and robust formulations in topology optimization,” *Structural and Multidisciplinary Optimization*, vol. 43, pp. 767–784, 2011.
3. M.P. Bendsøe, “Optimal shape design as a material distribution problem,” *Structural Optimization*, vol. 1, pp. 193–202, 1989.

---

**Application Library path:** `Structural_Mechanics_Module/Tutorials/bracket_topology_optimization_stl`

---

## Modeling Instructions



---

From the **File** menu, choose **New**.

### NEW

In the **New** window, click  **Model Wizard**.

## MODEL WIZARD

- 1 In the **Model Wizard** window, click  **3D**.
- 2 In the **Select Physics** tree, select **Structural Mechanics > Solid Mechanics (solid)**.
- 3 Click **Add**.
- 4 Click  **Study**.
- 5 In the **Select Study** tree, select **Preset Studies for Selected Physics Interfaces > Optimization > Topology Optimization, Stationary**.
- 6 Click  **Done**.



## GLOBAL DEFINITIONS

### *Parameters I*

- 1 In the **Model Builder** window, under **Global Definitions** click **Parameters I**.
- 2 In the **Settings** window for **Parameters**, locate the **Parameters** section.
- 3 Click  **Load from File**.
- 4 Browse to the model's Application Libraries folder and double-click the file `bracket_topology_optimization_stl_parameters.txt`.

## GEOMETRY I

Create the geometry. To simplify this step, insert a prepared geometry sequence.

- 1 In the **Geometry** toolbar, click **Insert Sequence** and choose **Insert Sequence**.
- 2 Browse to the model's Application Libraries folder and double-click the file `bracket_topology_optimization_stl_geom_sequence.mph`.
- 3 In the **Geometry** toolbar, click  **Build All**.
- 4 Click the  **Zoom Extents** button in the **Graphics** toolbar.

5 In the **Model Builder** window, under **Component 1 (comp1)** click **Geometry 1**.

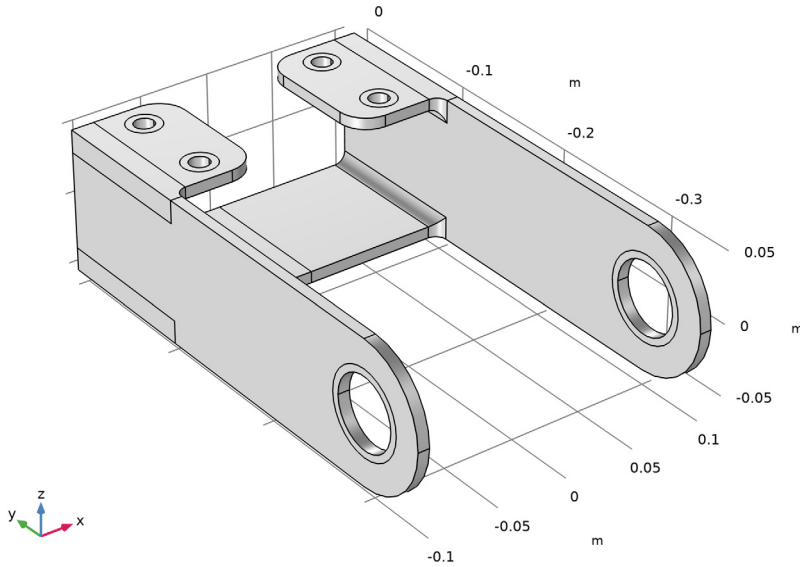

The geometry should now look like that in [Figure 1](#).

6 In the **Model Builder** window, collapse the **Geometry 1** node.

### GLOBAL DEFINITIONS

Add a new parameter group and a function for imposing the forces on the two large holes. The forces correspond to a torque on the bracket.

1 In the **Model Builder** window, under **Global Definitions** click **Parameters 1**.

2 In the **Settings** window for **Parameters**, type Geometrical Parameters in the **Label** text field.

#### Parameters 2

1 In the **Home** toolbar, click **P<sub>i</sub> Parameters** and choose **Add > Parameters**.

2 In the **Settings** window for **Parameters**, locate the **Parameters** section.

3 In the table, enter the following settings:

Name	Expression	Value	Description
Lmin	5[mm]	0.005 m	Filter radius
meshsz	Lmin	0.005 m	Mesh size

Name	Expression	Value	Description
meshsz2	Lmin/2	0.0025 m	Fine mesh size
P0	2.5[MPa]	2.5E6 Pa	Peak load intensity

## DEFINITIONS



### *Analytic 1 (an1)*

- 1 In the **Definitions** toolbar, click  **Analytic**.
- 2 In the **Settings** window for **Analytic**, type load in the **Function name** text field.
- 3 Locate the **Definition** section. In the **Expression** text field, type  $F \cdot \cos(\text{atan2}(py, \text{abs}(px)))$ .
- 4 In the **Arguments** text field, type  $F, px, py$ .
- 5 Locate the **Units** section. In the table, enter the following settings:

Argument	Unit
F	Pa
px	m
py	m

- 6 In the **Function** text field, type Pa.

## ADD MATERIAL

- 1 In the **Materials** toolbar, click  **Add Material** to open the **Add Material** window.
- 2 Go to the **Add Material** window.
- 3 In the tree, select **Built-in > Structural steel**.
- 4 Right-click and choose **Add to Global Materials**.
- 5 In the **Materials** toolbar, click  **Add Material** to close the **Add Material** window.

## MATERIALS

### *Topology Link 1 (toplnk1)*

- 1 In the **Settings** window for **Topology Link**, locate the **Link Settings** section.
- 2 From the **Material** list, choose **Structural steel (mat1)**.



## SOLID MECHANICS (SOLID)

### *Fixed Constraint 1*



- 1 In the **Physics** toolbar, click  **Boundaries** and choose **Fixed Constraint**.

- 2 In the **Settings** window for **Fixed Constraint**, locate the **Boundary Selection** section.
- 3 From the **Selection** list, choose **Constraint 1**.
- 4 In the **Physics** toolbar, click  **Constraint Group** and choose **New Constraint Group**.



#### *Fixed Constraint 2*

- 1 In the **Physics** toolbar, click  **Boundaries** and choose **Fixed Constraint**.
- 2 In the **Settings** window for **Fixed Constraint**, locate the **Boundary Selection** section.
- 3 From the **Selection** list, choose **Constraint 2**.
- 4 In the **Physics** toolbar, click  **Constraint Group** and choose **New Constraint Group**.

#### *Fixed Constraint 3*

- 1 In the **Physics** toolbar, click  **Boundaries** and choose **Fixed Constraint**.
- 2 In the **Settings** window for **Fixed Constraint**, locate the **Boundary Selection** section.
- 3 From the **Selection** list, choose **Constraint 3**.
- 4 In the **Physics** toolbar, click  **Constraint Group** and choose **New Constraint Group**.

#### *Fixed Constraint 4*

- 1 In the **Physics** toolbar, click  **Boundaries** and choose **Fixed Constraint**.
- 2 In the **Settings** window for **Fixed Constraint**, locate the **Boundary Selection** section.
- 3 From the **Selection** list, choose **Constraint 4**.
- 4 In the **Physics** toolbar, click  **Constraint Group** and choose **New Constraint Group**.

#### *Boundary Load 1*

- 1 In the **Physics** toolbar, click  **Boundaries** and choose **Boundary Load**.
- 2 In the **Settings** window for **Boundary Load**, locate the **Boundary Selection** section.
- 3 From the **Selection** list, choose **Load 1**.
- 4 Locate the **Coordinate System Selection** section. From the **Coordinate system** list, choose **Boundary System 1 (sys1)**.
- 5 Locate the **Force** section. Specify the  $\mathbf{f}_A$  vector as

0	t1
0	t2
load (-P0, Y-YC, Z)	n

- 6 In the **Physics** toolbar, click  **Load Group** and choose **New Load Group**.

## MESH I

Mesh one side of the domain using swept and tetrahedral meshes.

### *Free Triangular I*

- 1 In the **Mesh** toolbar, click  **More Generators** and choose **Free Triangular**.
- 2 Select Boundaries 1, 4, 33, 37, 43, and 47 only.

### *Size*

- 1 In the **Model Builder** window, click **Size**.
- 2 In the **Settings** window for **Size**, locate the **Element Size** section.
- 3 Click the **Custom** button.
- 4 Locate the **Element Size Parameters** section. In the **Maximum element size** text field, type meshsz.
- 5 In the **Minimum element size** text field, type meshsz/2.

### *Swept I*

- 1 In the **Mesh** toolbar, click  **Swept**.
- 2 In the **Settings** window for **Swept**, locate the **Domain Selection** section.
- 3 From the **Geometric entity level** list, choose **Domain**.
- 4 From the **Selection** list, choose **Swept Domains**.

### *Free Tetrahedral I*

- 1 In the **Mesh** toolbar, click  **Free Tetrahedral**.
- 2 In the **Settings** window for **Free Tetrahedral**, locate the **Domain Selection** section.
- 3 From the **Geometric entity level** list, choose **Domain**.
- 4 From the **Selection** list, choose **Free Tetrahedral Domains**.

Copy the mesh from one side to the other.

### *Copy Domain I*

- 1 In the **Model Builder** window, right-click **Mesh I** and choose **Copying Operations** > **Copy Domain**.
- 2 In the **Settings** window for **Copy Domain**, locate the **Source Domains** section.
- 3 From the **Selection** list, choose **Source Domain**.
- 4 Locate the **Destination Domains** section. From the **Selection** list, choose **Destination Domain**.

## GLOBAL DEFINITIONS

### Parameters 2

- 1 In the **Model Builder** window, under **Global Definitions** click **Parameters 2**.
- 2 In the **Settings** window for **Parameters**, locate the **Parameters** section.
- 3 In the table, enter the following settings:

Name	Expression	Value	Description
Vfrac	0.5	0.5	Volume fraction
simpP	1	1	SIMP exponent
proj_beta	1	1	Projection slope

The characteristic strain energy is taken as double the computed value to compensate for the fact that half of the material will be removed.

Set up the density topology feature and let it control Young's modulus.

## TOPOLOGY OPTIMIZATION

### Density Model 1 (dtopol)

- 1 In the **Model Builder** window, under **Component 1 (comp1) > Topology Optimization** click **Density Model 1 (dtopol)**.
- 2 In the **Settings** window for **Density Model**, locate the **Geometric Entity Selection** section.
- 3 From the **Selection** list, choose **Design Space Domains**.
- 4 Locate the **Filtering** section. From the  $R_{\min}$  list, choose **User defined**.
- 5 In the text field, type  $L_{\min}$ .  
The filter radius must be larger or equal to the mesh size.
- 6 Locate the **Projection** section. From the **Projection type** list, choose **Hyperbolic tangent projection**.
- 7 In the  $\beta$  text field, type proj\_beta.
- 8 Locate the **Interpolation** section. From the  $p_{\text{SIMP}}$  list, choose **User defined**.
- 9 In the text field, type simpP.
- 10 Locate the **Control Variable Discretization** section. From the **Element order** list, choose **Constant**.
- 11 Locate the **Control Variable Initial Value** section. In the  $\theta_0$  text field, type Vfrac.

### Prescribed Material 1

- 1 In the **Topology Optimization** toolbar, click  **Prescribed Material**.

- 2 In the **Settings** window for **Prescribed Material**, locate the **Geometric Entity Selection** section.
- 3 From the **Selection** list, choose **Domains Outside Design Space**.

#### *Prescribed Material Boundary I*

- 1 In the **Topology Optimization** toolbar, click  **Prescribed Material Boundary**.
- 2 In the **Settings** window for **Prescribed Material Boundary**, locate the **Geometric Entity Selection** section.
- 3 From the **Selection** list, choose **Material Boundaries**.



#### *Mirror Symmetry I*

- 1 In the **Topology Optimization** toolbar, click  **Mirror Symmetry**.
- 2 In the **Settings** window for **Mirror Symmetry**, locate the **Geometric Entity Selection** section.
- 3 From the **Selection** list, choose **Mirror Domain**.

### **STUDY I**

#### *Step I: Stationary*

Disable the imposed symmetry in this initial study.

- 1 In the **Model Builder** window, under **Study I** click **Step I: Stationary**.
- 2 In the **Settings** window for **Stationary**, locate the **Physics and Variables Selection** section.
- 3 Select the **Modify model configuration for study step** checkbox.
- 4 In the tree, select **Component I (comp1) > Topology Optimization > Mirror Symmetry I**.
- 5 Click  **Disable**.
- 6 Click to expand the **Study Extensions** section. Select the **Define load cases** checkbox.
- 7 Click  **Add**.
- 8 In the table, enter the following settings:

Load case	lg1	Weight	cg1	cg2	cg3	cg4
Load case 1	√	1.0	√	√	√	√

#### *Topology Optimization*

- 1 In the **Model Builder** window, click **Topology Optimization**.
- 2 In the **Settings** window for **Topology Optimization**, locate the **Optimization Solver** section.

3 In the **Maximum number of iterations** text field, type 50.

4 Locate the **Constraints** section. In the table, enter the following settings:

Expression	Lower bound	Upper bound
comp1.dtopo1.theta_avg		Vfrac

5 In the **Model Builder** window, click **Study 1**.

6 In the **Settings** window for **Study**, type Study 1: One Load Case, No Symmetry in the **Label** text field.

7 In the **Study** toolbar, click  **Get Initial Value**.

Use the plot to show the design during the optimization.

8 In the **Model Builder** window, click **Topology Optimization**.

9 In the **Settings** window for **Topology Optimization**, click to expand the **Output** section.

10 Select the **Plot** checkbox.

11 From the **Plot group** list, choose **Threshold**.

In general it is best to scale the objective function with the initial value, but in this case the scale is close enough to 1 that it is unnecessary.

12 In the **Model Builder** window, click **Study 1: One Load Case, No Symmetry**.

13 In the **Settings** window for **Study**, locate the **Study Settings** section.

14 Clear the **Generate default plots** checkbox.

### *Parametric Sweep*

1 In the **Study** toolbar, click  **Parametric Sweep**.

2 In the **Settings** window for **Parametric Sweep**, locate the **Study Settings** section.

3 Click  **Add** twice.

4 In the table, enter the following settings:

Parameter name	Parameter value list	Parameter unit
simpP (SIMP exponent)	1 2 3 4	
proj_beta (Projection slope)	2 4 6 8	

5 Click to expand the **Advanced Settings** section. Select the **Reuse solution from previous step** checkbox.

6 In the **Study** toolbar, click  **Compute**.

## RESULTS



### *One Load Case*

- 1 In the **Model Builder** window, under **Results** click **Topology Optimization**.
- 2 In the **Settings** window for **Group**, type One Load Case in the **Label** text field.

### *Stress (solid)*

- 1 In the **Model Builder** window, expand the **One Load Case** node, then click **Stress (solid)**.
- 2 Drag and drop above **One Load Case > Output material volume factor**.

### *Threshold*

- 1 In the **Model Builder** window, click **Threshold**.
- 2 In the **Threshold** toolbar, click  **Plot**.
- 3 Click the  **Zoom Extents** button in the **Graphics** toolbar.



The resulting design is asymmetric due to the load and the two halves are poorly connected. If one of the bolts breaks, significant stiffness will be lost. Add a second load case together with a study using two load groups and four constraints giving a total of four load cases. Run the optimization again to see what effect this has on the optimal design.

## SOLID MECHANICS (SOLID)

### *Boundary Load 2*

- 1 In the **Model Builder** window, under **Component 1 (comp1) > Solid Mechanics (solid)** right-click **Boundary Load 1** and choose **Duplicate**.
- 2 In the **Settings** window for **Boundary Load**, locate the **Boundary Selection** section.
- 3 From the **Selection** list, choose **Load 2**.
- 4 In the **Physics** toolbar, click  **Load Group** and choose **New Load Group**.

## ADD STUDY

- 1 In the **Home** toolbar, click  **Add Study** to open the **Add Study** window.
- 2 Go to the **Add Study** window.
- 3 Find the **Studies** subsection. In the **Select Study** tree, select **General Studies > Stationary**.
- 4 Click the **Add Study** button in the window toolbar.
- 5 In the **Home** toolbar, click  **Add Study** to close the **Add Study** window.

## STUDY 2

### Step 1: Stationary

We are effectively solving for four load cases, but it is sufficient to consider two load cases due to the use of the **Mirror Symmetry** feature in the **Topology Optimization** interface.

- 1 In the **Settings** window for **Stationary**, locate the **Study Extensions** section.
- 2 Select the **Define load cases** checkbox.
- 3 Click **+ Add** twice.
- 4 In the table, enter the following settings:

Load case	lg1	Weight	lg2	Weight	cg1	cg2	cg3	cg4
Load case 1	√	1.0		1.0		√	√	√
Load case 2		1.0	√	1.0	√		√	√

- 5 In the **Model Builder** window, click **Study 2**.
- 6 In the **Settings** window for **Study**, type **Study 2: Two Load Cases** in the **Label** text field.
- 7 In the **Study** toolbar, click **= Compute**.

## STUDY 1: ONE LOAD CASE, NO SYMMETRY

### Parametric Sweep, Topology Optimization

Right-click and choose **Copy**.

## STUDY 2: TWO LOAD CASES

In the **Model Builder** window, right-click **Study 2: Two Load Cases** and choose **Paste Multiple Items**.

### Topology Optimization

- 1 In the **Settings** window for **Topology Optimization**, locate the **Objective Function** section.
- 2 In the table, enter the following settings:

Expression	Description
comp1.solid.Ws_tot/4	

- 3 Locate the **Output** section. From the **Plot group** list, choose **Threshold 1**.
- 4 In the **Model Builder** window, click **Study 2: Two Load Cases**.

5 In the **Settings** window for **Study**, locate the **Study Settings** section.

6 Clear the **Generate default plots** checkbox.

The default direct solver works, but the computational time can be decreased by using the iterative solver and avoiding reuse of the sparsity pattern. Finally, the log becomes cleaner if the solver is not allowed to change the order of the load cases.

#### *Solution 7 (sol7)*

1 In the **Model Builder** window, right-click **Solver Configurations** and choose **Reset Solver to Default**.

2 Expand the **Solution 7 (sol7)** node.

3 In the **Model Builder** window, expand the **Study 2: Two Load Cases > Solver Configurations > Solution 7 (sol7) > Optimization Solver 1 > Stationary Solver 1 > Segregated 1** node, then click **Maximum Material Length Scale**.

4 In the **Settings** window for **Segregated Step**, locate the **General** section.

5 From the **Linear solver** list, choose **Suggested Iterative Solver (GMRES with SA AMG) (solid)**.

6 In the **Model Builder** window, click **Segregated 1**.

7 In the **Settings** window for **Segregated**, locate the **General** section.

8 From the **Termination technique** list, choose **Iterations** to reduce the computational time.

9 In the **Model Builder** window, click **Advanced**.

10 In the **Settings** window for **Advanced**, click to expand the **Assembly Settings** section.

11 Clear the **Reuse sparsity pattern** checkbox.

12 In the **Model Builder** window, click **Parametric**.

13 In the **Settings** window for **Parametric**, locate the **General** section.

14 From the **Parameter value run order** list, choose **As specified**.

15 In the **Study** toolbar, click  **Compute**.

## **RESULTS**

### *Two Load Cases*

1 In the **Model Builder** window, under **Results** click **Topology Optimization**.

2 In the **Settings** window for **Group**, type Two Load Cases in the **Label** text field.

### *Stress (solid) 1*

- 1 In the **Model Builder** window, expand the **Two Load Cases** node, then click **Stress (solid) 1**.
- 2 Drag and drop above **Two Load Cases** > **Output material volume factor 1**.

### *Threshold 1*

- 1 In the **Model Builder** window, click **Threshold 1**.
- 2 In the **Threshold 1** toolbar, click  **Plot**.

Now the design is symmetric and the two halves are better connected.

- 3 Click the  **Zoom Extents** button in the **Graphics** toolbar.

Add a finer mesh and solve for the filtered material volume factor.

## **MESH 1**



In the **Model Builder** window, under **Component 1 (comp1)** right-click **Mesh 1** and choose **Duplicate**.

## **MESH 2**

### *Size*

- 1 In the **Model Builder** window, expand the **Mesh 2** node, then click **Size**.
- 2 In the **Settings** window for **Size**, locate the **Element Size Parameters** section.
- 3 In the **Maximum element size** text field, type  $\text{meshsz}/2$ .
- 4 In the **Minimum element size** text field, type  $\text{meshsz}/4$ .
- 5 Click  **Build All**.

## **ADD STUDY**

- 1 In the **Home** toolbar, click  **Add Study** to open the **Add Study** window.
- 2 Go to the **Add Study** window.
- 3 Find the **Studies** subsection. In the **Select Study** tree, select **General Studies** > **Stationary**.
- 4 Find the **Physics interfaces in study** subsection. In the table, clear the **Solve** checkbox for **Solid Mechanics (solid)**.
- 5 Click the **Add Study** button in the window toolbar.
- 6 In the **Home** toolbar, click  **Add Study** to close the **Add Study** window.

### STUDY 3: SMOOTH DESIGN (MESH2)

In the **Settings** window for **Study**, type Study 3: Smooth Design (mesh2) in the **Label** text field.

#### *Solution 13 (sol13)*

In the **Study** toolbar, click  **Show Default Solver**.

#### *Step 1: Stationary*

- 1 In the **Model Builder** window, under **Study 3: Smooth Design (mesh2)** click **Step 1: Stationary**.
- 2 In the **Settings** window for **Stationary**, click to expand the **Values of Dependent Variables** section.
- 3 Find the **Initial values of variables solved for** subsection. From the **Settings** list, choose **User controlled**.
- 4 From the **Method** list, choose **Solution**.
- 5 From the **Study** list, choose **Study 2: Two Load Cases, Stationary**.
- 6 In the **Study** toolbar, click  **Compute**.

### RESULTS

#### *Filter 2*

- 1 In the **Model Builder** window, expand the **Results > Datasets** node.
- 2 Right-click **Results > Datasets > Filter 2** and choose **Create Mesh-Based Geometry**.

### MESH-BASED GEOMETRY I

#### *Remesh Faces 1*

- 1 In the **Mesh** toolbar, click  **More Generators** and choose **Remesh Faces**.
- 2 In the **Settings** window for **Remesh Faces**, locate the **Boundary Selection** section.
- 3 From the **Selection** list, choose **All boundaries**.

#### *Size*

- 1 In the **Model Builder** window, expand the **Remesh Faces 1** node, then click **Size**.
- 2 In the **Settings** window for **Size**, click to expand the **Element Size Parameters** section.
- 3 In the **Maximum element size** text field, type meshsz.
- 4 In the **Minimum element size** text field, type meshsz/2.
- 5 In the **Curvature factor** text field, type 1.
- 6 In the **Resolution of narrow regions** text field, type 0.

7 Click  **Build All**.

## MATERIALS

### *Material Link 1 (matlnk1)*

In the **Model Builder** window, under **Component 2 (comp2)** right-click **Materials** and choose **More Materials > Material Link**.

## SOLID MECHANICS (SOLID)

Copy/paste the physics from the first component and fix the selections.

1 In the **Model Builder** window, under **Component 1 (comp1)** right-click **Solid Mechanics (solid)** and choose **Copy**.

## SOLID MECHANICS (SOLID2)

1 In the **Model Builder** window, right-click **Component 2 (comp2)** and choose **Paste Solid Mechanics**.

2 In the **Messages from Paste** dialog, click **OK**.

You can use second-order displacements now that you have an explicit geometry representation.

3 In the **Settings** window for **Solid Mechanics**, click to expand the **Discretization** section.

4 From the **Displacement field** list, choose **Quadratic serendipity**.

### *Fixed Constraint 1*

1 In the **Model Builder** window, expand the **Solid Mechanics (solid2)** node, then click **Fixed Constraint 1**.

2 In the **Settings** window for **Fixed Constraint**, locate the **Boundary Selection** section.

3 From the **Selection** list, choose **Constraint 1**.

### *Fixed Constraint 2*

1 In the **Model Builder** window, click **Fixed Constraint 2**.

2 In the **Settings** window for **Fixed Constraint**, locate the **Boundary Selection** section.

3 From the **Selection** list, choose **Constraint 2**.

### *Fixed Constraint 3*

1 In the **Model Builder** window, click **Fixed Constraint 3**.

2 In the **Settings** window for **Fixed Constraint**, locate the **Boundary Selection** section.

3 From the **Selection** list, choose **Constraint 3**.

#### Fixed Constraint 4

- 1 In the **Model Builder** window, click **Fixed Constraint 4**.
- 2 In the **Settings** window for **Fixed Constraint**, locate the **Boundary Selection** section.
- 3 From the **Selection** list, choose **Constraint 4**.

#### Boundary Load 1

- 1 In the **Model Builder** window, click **Boundary Load 1**.
- 2 In the **Settings** window for **Boundary Load**, locate the **Boundary Selection** section.
- 3 From the **Selection** list, choose **Load 1**.
- 4 Locate the **Force** section. Specify the  $\mathbf{f}_A$  vector as

0	x
0	y
comp1.load(-P0,Y-YC,Z)	z

#### Boundary Load 2

- 1 In the **Model Builder** window, click **Boundary Load 2**.
- 2 In the **Settings** window for **Boundary Load**, locate the **Boundary Selection** section.
- 3 From the **Selection** list, choose **Load 2**.
- 4 Locate the **Force** section. Specify the  $\mathbf{f}_A$  vector as

0	x
0	y
comp1.load(-P0,Y-YC,Z)	z

#### COMPONENT 1: OPTIMIZATION

- 1 In the **Model Builder** window, click **Component 1 (comp1)**.
- 2 In the **Settings** window for **Component**, type Component 1: Optimization in the **Label** text field.

#### COMPONENT 2: VERIFICATION

- 1 In the **Model Builder** window, click **Component 2 (comp2)**.
- 2 In the **Settings** window for **Component**, type Component 2: Verification in the **Label** text field.

## MESH 3



### *Free Tetrahedral 1*

In the **Mesh** toolbar, click  **Free Tetrahedral**.

### *Size*

- 1 In the **Model Builder** window, expand the **Free Tetrahedral 1** node, then click **Component 2: Verification (comp2) > Mesh 3 > Size**.
- 2 In the **Settings** window for **Size**, locate the **Element Size** section.
- 3 From the **Predefined** list, choose **Extremely fine**.
- 4 Click  **Build All**.

## ADD STUDY

- 1 In the **Home** toolbar, click  **Add Study** to open the **Add Study** window.
- 2 Go to the **Add Study** window.
- 3 Find the **Physics interfaces in study** subsection. In the table, clear the **Solve** checkbox for **Solid Mechanics (solid)**.  
The filtered material volume factor is always solved for, but this takes less time on the coarse mesh.
- 4 Find the **Studies** subsection. In the **Select Study** tree, select **Empty Study**.
- 5 Click the **Add Study** button in the window toolbar.
- 6 In the **Home** toolbar, click  **Add Study** to close the **Add Study** window.

## STUDY 4: VERIFICATION

- 1 In the **Settings** window for **Study**, type Study 4: Verification in the **Label** text field.
- 2 Locate the **Study Settings** section. Clear the **Generate default plots** checkbox.

## STUDY 1: ONE LOAD CASE, NO SYMMETRY

### *Step 1: Stationary*

- 1 In the **Model Builder** window, under **Study 1: One Load Case, No Symmetry** click **Step 1: Stationary**.
- 2 In the **Settings** window for **Stationary**, locate the **Physics and Variables Selection** section.
- 3 In the tree, select **Component 2: Verification (comp2) > Solid Mechanics (solid2)**.
- 4 Click  **Disable in Solvers**.

### STUDY 3: SMOOTH DESIGN (MESH2)

- 1 In the **Model Builder** window, under **Study 3: Smooth Design (mesh2)** click **Step 1: Stationary**.
- 2 In the **Settings** window for **Stationary**, locate the **Physics and Variables Selection** section.
- 3 In the **Solve for** column of the table, under **Component 2: Verification (comp2)**, clear the checkbox for **Solid Mechanics (solid2)**.

### STUDY 2: TWO LOAD CASES

- 1 In the **Model Builder** window, under **Study 2: Two Load Cases** click **Step 1: Stationary**.
- 2 In the **Settings** window for **Stationary**, locate the **Physics and Variables Selection** section.
- 3 In the **Solve for** column of the table, under **Component 2: Verification (comp2)**, clear the checkbox for **Solid Mechanics (solid2)**.
- 4 Right-click **Study 2: Two Load Cases > Step 1: Stationary** and choose **Copy**.

### STUDY 4: VERIFICATION

In the **Model Builder** window, right-click **Study 4: Verification** and choose **Paste Stationary**.

- 1 In the **Settings** window for **Stationary**, locate the **Physics and Variables Selection** section.
- 2 In the **Solve for** column of the table, under **Component 2: Verification (comp2)**, select the checkbox for **Solid Mechanics (solid2)**.
- 3 In the **Solve for** column of the table, under **Component 1: Optimization (comp1)**, clear the checkbox for **Topology Optimization**.
- 4 In the **Study** toolbar, click  **Compute**.

Add a new 3D plot group to plot the displacement.

### RESULTS

#### *Topology Optimization*

In the **Model Builder** window, under **Results** right-click **Topology Optimization** and choose **Delete**.



#### *Displacement (solid2)*

- 1 In the **Results** toolbar, click  **3D Plot Group**.
- 2 In the **Settings** window for **3D Plot Group**, type **Displacement (solid2)** in the **Label** text field.
- 3 Locate the **Data** section. From the **Dataset** list, choose **Study 4: Verification/ Solution 14 (7) (sol14)**.

### *Surface 1*

Right-click **Displacement (solid2)** and choose **Surface**.

### *Deformation 1*

- 1 In the **Model Builder** window, right-click **Surface 1** and choose **Deformation**.
- 2 Click the  **Zoom Extents** button in the **Graphics** toolbar.
- 3 In the **Displacement (solid2)** toolbar, click  **Plot**.

## *Geometry Modeling Instructions*

---

If you want to create the geometry yourself, follow these steps.

### **GLOBAL DEFINITIONS**

#### *Parameters 1*

- 1 In the **Model Builder** window, under **Global Definitions** click **Parameters 1**.
- 2 In the **Settings** window for **Parameters**, locate the **Parameters** section.
- 3 Click  **Load from File**.
- 4 Browse to the model's Application Libraries folder and double-click the file `bracket_topology_optimization_stl_parameters.txt`.



### **ADD COMPONENT**

In the **Home** toolbar, click  **Add Component** and choose **3D**.

### **GEOMETRY 1**

Create the geometry. To simplify this step, import a prepared geometry.

#### *Import 1 (imp1)*

- 1 In the **Geometry** toolbar, click  **Import**.
- 2 In the **Settings** window for **Import**, locate the **Source** section.
- 3 From the **Source** list, choose **COMSOL Multiphysics file**.
- 4 Click  **Browse**.
- 5 Browse to the model's Application Libraries folder and double-click the file `bracket.mphbin`.
- 6 Click  **null**.

#### *Cylinder 1 (cyl1)*

- 1 In the **Geometry** toolbar, click  **Cylinder**.

- 2 In the **Settings** window for **Cylinder**, locate the **Size and Shape** section.
- 3 In the **Radius** text field, type  $D2/2+Da/2$ .
- 4 Locate the **Position** section. In the **x** text field, type  $-W/2$ .
- 5 In the **y** text field, type  $YC$ .
- 6 Locate the **Axis** section. From the **Axis type** list, choose **x-axis**.
- 7 Locate the **Selections of Resulting Entities** section. Select the **Resulting objects selection** checkbox.

#### *Cylinder 2 (cyl2)*

- 1 In the **Geometry** toolbar, click  **Cylinder**.
- 2 In the **Settings** window for **Cylinder**, locate the **Size and Shape** section.
- 3 In the **Radius** text field, type  $D1/2+Da/2$ .
- 4 Locate the **Position** section. In the **x** text field, type  $W/2-X1$ .
- 5 In the **y** text field, type  $-Y1$ .
- 6 Locate the **Selections of Resulting Entities** section. Select the **Resulting objects selection** checkbox.

#### *Move 1 (mov1)*

- 1 In the **Geometry** toolbar, click  **Transforms** and choose **Move**.
- 2 In the **Settings** window for **Move**, locate the **Input** section.
- 3 From the **Input objects** list, choose **Cylinder 2**.
- 4 Locate the **Displacement** section. In the **y** text field, type  $-DY1$ .
- 5 Locate the **Input** section. Select the **Keep input objects** checkbox.

#### *Block 1 (blk1)*

- 1 In the **Geometry** toolbar, click  **Block**.
- 2 In the **Settings** window for **Block**, locate the **Size and Shape** section.
- 3 In the **Width** text field, type  $r\text{fillet}+\text{thickness}$ .
- 4 In the **Depth** text field, type  $L1+r\text{fillet}$ .
- 5 In the **Height** text field, type  $r\text{fillet}+\text{thickness}$ .
- 6 Locate the **Position** section. In the **x** text field, type  $W/2-r\text{fillet}-\text{thickness}$ .
- 7 In the **y** text field, type  $-L1-r\text{fillet}$ .
- 8 In the **z** text field, type  $H/2-r\text{fillet}-\text{thickness}$ .

### *Mirror 1 (mir1)*

- 1 In the **Geometry** toolbar, click  **Transforms** and choose **Mirror**.
- 2 Select the object **blk1** only.
- 3 In the **Settings** window for **Mirror**, locate the **Input** section.
- 4 Select the **Keep input objects** checkbox.

### *Mirror 2 (mir2)*



- 1 In the **Geometry** toolbar, click  **Transforms** and choose **Mirror**.
- 2 Select the objects **blk1**, **cyl2**, **mir1**, and **mov1** only.
- 3 In the **Settings** window for **Mirror**, locate the **Normal Vector to Plane of Reflection** section.
- 4 In the **x** text field, type 1.
- 5 In the **z** text field, type 0.
- 6 Locate the **Input** section. Select the **Keep input objects** checkbox.

Add a big block to introduce a symmetry boundary in the geometry. The geometry can still be viewed by hiding the boundaries of the big block.

### *Block 2 (blk2)*

- 1 In the **Geometry** toolbar, click  **Block**.
- 2 In the **Settings** window for **Block**, locate the **Position** section.
- 3 In the **y** text field, type -1.
- 4 In the **z** text field, type  $-H/2$ .

### *Partition Objects 1 (par1)*

- 1 In the **Geometry** toolbar, click  **Booleans and Partitions** and choose **Partition Objects**.
- 2 Select the object **imp1** only.
- 3 In the **Settings** window for **Partition Objects**, locate the **Partition Objects** section.
- 4 Click to select the  **Activate Selection** toggle button for **Tool objects**.
- 5 Select the objects **blk1**, **blk2**, **cyl1**, **cyl2**, **mir1**, **mir2(1)**, **mir2(2)**, **mir2(3)**, **mir2(4)**, and **mov1** only.
- 6 Locate the **Selections of Resulting Entities** section. Select the **Resulting objects selection** checkbox.

### *Constraint 1*

- 1 In the **Geometry** toolbar, click  **Selections** and choose **Cylinder Selection**.
- 2 In the **Settings** window for **Cylinder Selection**, type Constraint 1 in the **Label** text field.

- 3 Locate the **Geometric Entity Level** section. From the **Level** list, choose **Boundary**.
- 4 Locate the **Size and Shape** section. In the **Outer radius** text field, type  $D1/2*1.01$ .
- 5 Locate the **Position** section. In the **x** text field, type  $W/2-X1$ .
- 6 In the **y** text field, type  $-Y1$ .
- 7 Locate the **Output Entities** section. From the **Include entity if** list, choose **Entity inside cylinder**.

*Constraint 2*

- 1 Right-click **Constraint 1** and choose **Duplicate**.
- 2 In the **Settings** window for **Cylinder Selection**, type Constraint 2 in the **Label** text field.
- 3 Locate the **Position** section. In the **y** text field, type  $-Y1-DY1$ .

*Constraint 3*

- 1 Right-click **Constraint 2** and choose **Duplicate**.
- 2 In the **Settings** window for **Cylinder Selection**, type Constraint 3 in the **Label** text field.
- 3 Locate the **Position** section. In the **x** text field, type  $-W/2+X1$ .

*Constraint 4*

- 1 Right-click **Constraint 3** and choose **Duplicate**.
- 2 In the **Settings** window for **Cylinder Selection**, type Constraint 4 in the **Label** text field.
- 3 Locate the **Position** section. In the **y** text field, type  $-Y1$ .

*Load 1a*

- 1 In the **Geometry** toolbar, click  **Selections** and choose **Cylinder Selection**.
- 2 In the **Settings** window for **Cylinder Selection**, type Load 1a in the **Label** text field.
- 3 Locate the **Geometric Entity Level** section. From the **Level** list, choose **Boundary**.
- 4 Locate the **Size and Shape** section. In the **Outer radius** text field, type  $D2/2*1.01$ .
- 5 In the **Bottom distance** text field, type 0.
- 6 In the **Start angle** text field, type 90.
- 7 In the **End angle** text field, type 270.
- 8 Locate the **Position** section. In the **y** text field, type  $YC$ .
- 9 Locate the **Axis** section. From the **Axis type** list, choose **x-axis**.
- 10 Locate the **Output Entities** section. From the **Include entity if** list, choose **Entity inside cylinder**.

#### *Load 1b*

- 1 Right-click **Load 1a** and choose **Duplicate**.
- 2 In the **Settings** window for **Cylinder Selection**, type Load 1b in the **Label** text field.
- 3 Locate the **Size and Shape** section. In the **Start angle** text field, type -90.
- 4 In the **End angle** text field, type 90.



#### *Load 2a*

- 1 Right-click **Load 1b** and choose **Duplicate**.
- 2 In the **Settings** window for **Cylinder Selection**, type Load 2a in the **Label** text field.
- 3 Locate the **Size and Shape** section. In the **Top distance** text field, type 0.
- 4 In the **Bottom distance** text field, type -Inf.



#### *Load 2b*

- 1 Right-click **Load 2a** and choose **Duplicate**.
- 2 In the **Settings** window for **Cylinder Selection**, type Load 2b in the **Label** text field.
- 3 Locate the **Size and Shape** section. In the **Start angle** text field, type 90.
- 4 In the **End angle** text field, type 270.

#### *Load 1*

- 1 In the **Geometry** toolbar, click  **Selections** and choose **Union Selection**.
- 2 In the **Settings** window for **Union Selection**, type Load 1 in the **Label** text field.
- 3 Locate the **Geometric Entity Level** section. From the **Level** list, choose **Boundary**.
- 4 Locate the **Input Entities** section. Click  **Add**.
- 5 In the **Add** dialog, in the **Selections to add** list, choose **Load 1a** and **Load 2a**.
- 6 Click **OK**.

#### *Load 2*

- 1 In the **Geometry** toolbar, click  **Selections** and choose **Union Selection**.
- 2 In the **Settings** window for **Union Selection**, type Load 2 in the **Label** text field.
- 3 Locate the **Geometric Entity Level** section. From the **Level** list, choose **Boundary**.
- 4 Locate the **Input Entities** section. Click  **Add**.
- 5 In the **Add** dialog, in the **Selections to add** list, choose **Load 1b** and **Load 2b**.
- 6 Click **OK**.

#### *Domains Outside Design Space*

- 1 In the **Geometry** toolbar, click  **Selections** and choose **Adjacent Selection**.

- 2 In the **Settings** window for **Adjacent Selection**, type Domains Outside Design Space in the **Label** text field.
- 3 Locate the **Input Entities** section. From the **Geometric entity level** list, choose **Boundary**.
- 4 Locate the **Output Entities** section. From the **Geometric entity level** list, choose **Adjacent domains**.
- 5 Locate the **Input Entities** section. Click **+ Add**.
- 6 In the **Add** dialog, in the **Input selections** list, choose **Constraint 1**, **Constraint 2**, **Constraint 3**, and **Constraint 4**.
- 7 Click **OK**.

#### *Design Space Domains*

- 1 In the **Geometry** toolbar, click  **Selections** and choose **Difference Selection**.
- 2 In the **Settings** window for **Difference Selection**, type Design Space Domains in the **Label** text field.
- 3 Locate the **Input Entities** section. Click the **+ Add** button for **Selections to add**.
- 4 In the **Add** dialog, select **Partition Objects 1** in the **Selections to add** list.
- 5 Click **OK**.
- 6 In the **Settings** window for **Difference Selection**, locate the **Input Entities** section.
- 7 Click the **+ Add** button for **Selections to subtract**.
- 8 In the **Add** dialog, in the **Selections to subtract** list, choose **Cylinder 1** and **Cylinder 2**.
- 9 Click **OK**.

#### *Material Boundaries*

- 1 In the **Geometry** toolbar, click  **Selections** and choose **Cylinder Selection**.
- 2 In the **Settings** window for **Cylinder Selection**, type Material Boundaries in the **Label** text field.
- 3 Locate the **Geometric Entity Level** section. From the **Level** list, choose **Boundary**.
- 4 Locate the **Size and Shape** section. In the **Outer radius** text field, type  $Da+D2/2*1.01$ .
- 5 Locate the **Position** section. In the **y** text field, type  $YC$ .
- 6 Locate the **Axis** section. From the **Axis type** list, choose **x-axis**.
- 7 Locate the **Output Entities** section. From the **Include entity if** list, choose **Entity inside cylinder**.

#### *Source Domain*

- 1 In the **Geometry** toolbar, click  **Selections** and choose **Box Selection**.

- 2 In the **Settings** window for **Box Selection**, type Source Domain in the **Label** text field.
- 3 Locate the **Box Limits** section. In the **x maximum** text field, type eps.
- 4 Locate the **Output Entities** section. From the **Include entity if** list, choose **Entity inside box**.

#### *Destination Domain*

- 1 In the **Geometry** toolbar, click  **Selections** and choose **Box Selection**.
- 2 In the **Settings** window for **Box Selection**, type Destination Domain in the **Label** text field.
- 3 Locate the **Box Limits** section. In the **x minimum** text field, type -eps.
- 4 Locate the **Output Entities** section. From the **Include entity if** list, choose **Entity inside box**.

#### *Free Tetrahedral Domains*

- 1 In the **Geometry** toolbar, click  **Selections** and choose **Box Selection**.
- 2 In the **Settings** window for **Box Selection**, type Free Tetrahedral Domains in the **Label** text field.
- 3 Locate the **Box Limits** section. In the **x minimum** text field, type  $-W/2+thickness+rfillet*0.4$ .
- 4 In the **x maximum** text field, type  $-W/2+thickness+rfillet*0.6$ .

#### *Swept Domains*

- 1 In the **Geometry** toolbar, click  **Selections** and choose **Difference Selection**.
- 2 In the **Settings** window for **Difference Selection**, type Swept Domains in the **Label** text field.
- 3 Locate the **Input Entities** section. Click the **+ Add** button for **Selections to add**.
- 4 In the **Add** dialog, select **Source Domain** in the **Selections to add** list.
- 5 Click **OK**.
- 6 In the **Settings** window for **Difference Selection**, locate the **Input Entities** section.
- 7 Click the **+ Add** button for **Selections to subtract**.
- 8 In the **Add** dialog, select **Free Tetrahedral Domains** in the **Selections to subtract** list.
- 9 Click **OK**.



*Design Space Domains (difsel1), Destination Domain (boxsel2), Domains Outside Design Space (adjsel1), Free Tetrahedral Domains (boxsel3), Material Boundaries (cylsel9), Source Domain (boxsel1), Swept Domains (difsel2)*

- 1 In the **Model Builder** window, under **Component 1 (comp1) > Geometry 1**, Ctrl-click to select **Domains Outside Design Space (adjsel1)**, **Design Space Domains (difsel1)**, **Material Boundaries (cylsel9)**, **Source Domain (boxsel1)**, **Destination Domain (boxsel2)**, **Free Tetrahedral Domains (boxsel3)**, and **Swept Domains (difsel2)**.
- 2 Right-click and choose **Group**.

#### *Meshing*

- 1 In the **Settings** window for **Group**, type Meshing in the **Label** text field.
- 2 In the **Home** toolbar, click  **Build All**.

#### *Mirror Domain*

- 1 In the **Geometry** toolbar, click  **Selections** and choose **Box Selection**.
- 2 In the **Settings** window for **Box Selection**, type Mirror Domain in the **Label** text field.
- 3 Locate the **Box Limits** section. In the **x minimum** text field, type 0.001\*W.
- 4 In the **y minimum** text field, type -L/2.
- 5 Click the  **Zoom Extents** button in the **Graphics** toolbar.  
The model geometry is now complete.