



Model created in COMSOL Multiphysics 6.4

Bipolar Transistor



This model shows how to set up a simple NPN bipolar transistor simulation. For this particular model, the current voltage characteristics in the static common-emitter configuration are computed and the common emitter current gain is determined.

Introduction

The invention of the Bipolar Transistor at Bell labs in the late 1940s was arguably the most significant technological development of the 20th century. Bipolar transistors were the workhorses of the first integrated circuits and consequently have had an enormous impact on the modern world. Although bipolar transistors have largely been replaced by field-effect devices in modern integrated circuits, they are still important, particularly in high-frequency applications.

The bipolar transistor is basically a three-terminal device whose resistance between two terminals is controlled by the third. In this example, we are going to show the static characteristics of a NPN bipolar transistor in common-emitter mode — that is, when the base and collector voltages are measured relative to the grounded emitter. [Figure 1](#) shows the biasing configuration of a NPN transistor in this configuration.

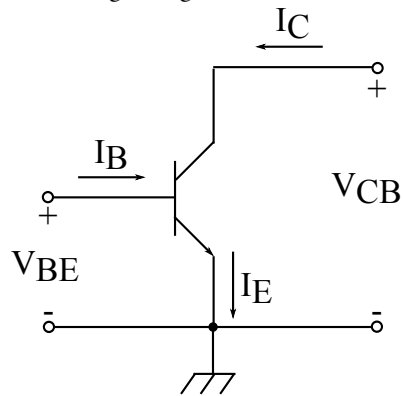

Figure 1: A NPN transistor in common-emitter configuration.

In the common-emitter mode, the base terminal of the transistor serves as the input, the collector is the output, and the emitter is common to both (in our case grounded). NPN transistors in common-emitter configuration give an inverted output and can have a high gain which is a strong function of the base current.

The model presented here shows how to perform a detailed characterization of a bipolar transistor in the common-emitter configuration.

Model Definition

The structure is half of the cross section of a simplified NPN bipolar transistor; see [Figure 2](#). The model uses the following dimensions: an emitter contact length of $1.2/2 \mu\text{m}$, a base contact length of $0.3 \mu\text{m}$ separated from the emitter contact by $0.35 \mu\text{m}$, and a collector contact length of $2.5/2 \mu\text{m}$. The total depth of the transistor is $1 \mu\text{m}$ with a width of $2.5/2 \mu\text{m}$. The modeled doping profile is shown in [Figure 2](#). As is typical of the profile used in silicon bipolar transistors, it consists of four regions (n^+ , p , n , and n^+) described in detail in [Modeling Instructions](#).

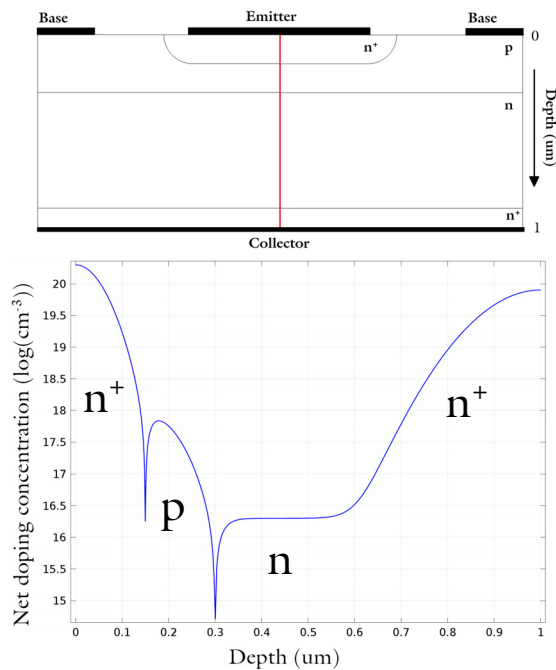

Figure 2: Top: The cross-section of the modeled transistor. The differently doped regions are labeled. The red line shows the axis of symmetry used to simplify the model geometry. Bottom: A line graph, taken along the axis of symmetry, showing the doping concentration. The labeled regions (n^+ , n , p) correspond with those in the geometry cross-section.

This model uses several studies to characterize the DC response of the bipolar transistor current output under both voltage and current driven configurations. First, a study sweeps the collector voltage from zero bias condition in order to give good initial conditions for the second study that sweeps the base voltage. This allows the currents at all three

terminals to be plotted as a function of V_{BE} and demonstrates that the simulation conserves current. This study is also used to create a Gummel plot, which shows the current at the collector and base contacts as a function of the base voltage. The same data is then used to calculate the current gain, defined as the ratio of the collector and base currents (I_C/I_E), as a function of the collector current. The current gain curve is an important characteristic for current regulation and power control applications, as it is used to calculate the expected collector output for a given base input.

The remaining studies are used to calculate the collector current as a function of the collector voltage for two different values for the base current. This is achieved using two studies that sweep the collector voltage, one with a fixed base current of $I_B = 2 \mu\text{A}$ and one with a fixed base current of $I_B = 10 \mu\text{A}$. These simulations are current driven because they are performed with a set base current applied. When solving current driven problems in COMSOL it is often necessary to provide good initial condition. In this model, the corresponding solution from the second study is used as the initial condition for the collector voltage sweeps.

Results and Discussion

Figure 3 displays the current at each terminal as a function of the base-emitter voltage (V_{BE}) for a fixed collector-emitter voltage ($V_{CE} = 0.5 \text{ V}$). Note that the figure shows the terminal currents using the software's sign convention: outward current from the semiconductor material is positive and inward current is negative. The figure also shows that the current is conserved. This can be seen as the difference between the emitter and collector currents, represented as magenta circles, matches the base current, shown in green. Thus the current is conserved, as

$$I_B = -I_E - I_C$$

Figure 4 shows the Gummel plot for the modeled bipolar transistor. The Gummel plot shows the magnitude of the collector and base currents, plotted on a logarithmic scale, as a function of the base voltage.

Figure 5 shows current gain, defined as I_C/I_B , as a function of the collector current at a fixed collector voltage of $V_{CE} = 0.5 \text{ V}$.

Figure 6 shows the collector current as a function of collector voltage for two different values of base current. This figure shows how a small base current can be used to control a larger collector current by changing the resistance between the emitter and collector terminals.

Figure 7 shows the voltage and carrier current densities throughout the device. With $V_{CE} = 1.5 \text{ V}$ the device is in the forward-active regime. In this regime the emitter–base junction is forward biased and the base–collector junction is reverse biased. Electrons are injected from the emitter into the base through the forward biased junction. These electrons then diffuse through the p-type base region as minority carriers. Those that make it to the reverse biased base–collector junction are swept toward the collector terminal by the junction electric field. The thickness of the base region must be small enough to allow the electrons to diffuse through with high probability. Holes can travel easily from the base to the emitter regions through the forward biased emitter–base junction, but they cannot traverse the reverse biased base–collector junction. Hence the hole current flows between the emitter and base terminals without entering the lower n-doped region, and the electron current flows between the emitter and collector terminals.

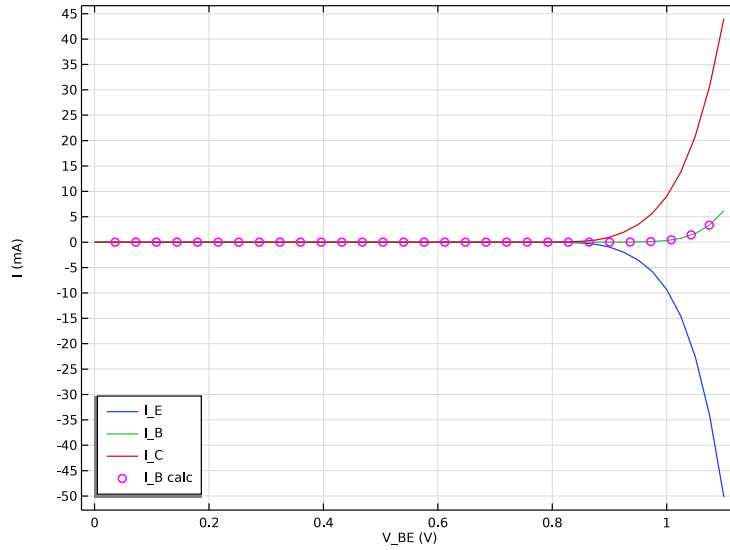

Figure 3: Terminal currents as a function of the base-emitter voltage (V_{BE}) for a fixed collector-emitter voltage ($V_{CE} = 0.5 \text{ V}$).

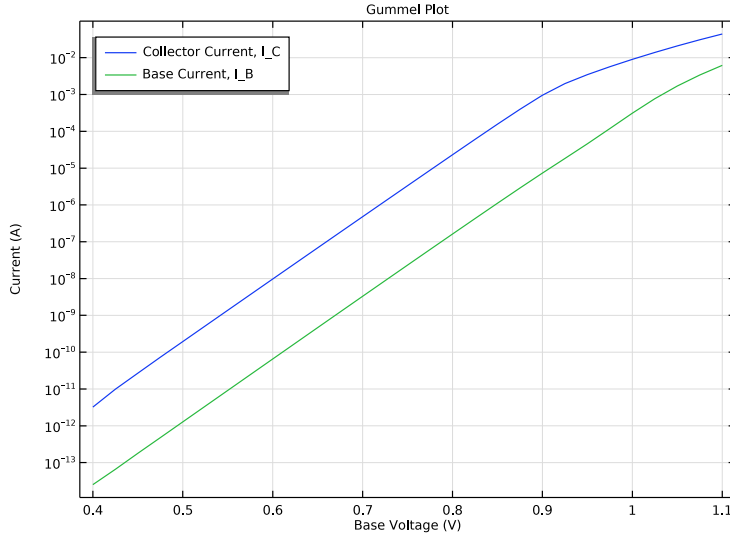

Figure 4: Gummel plot showing the magnitude of the collector and base current as a function of the base voltage.

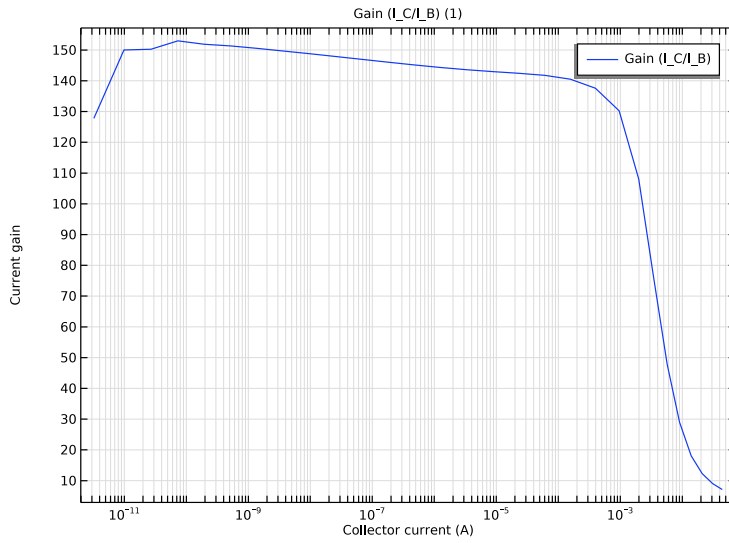

Figure 5: Current gain as a function of collector current for a fixed base voltage of $V_{CE}=0.5$ V.

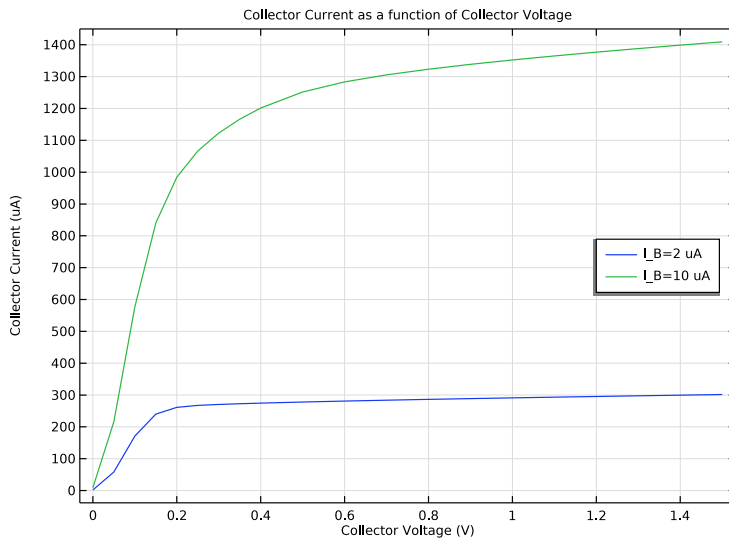

Figure 6: Plot of collector current vs. collector voltage for $I_B = 2 \mu A$ and $I_B = 10 \mu A$. Note that varying the base current controls the resistance between the emitter and collector.

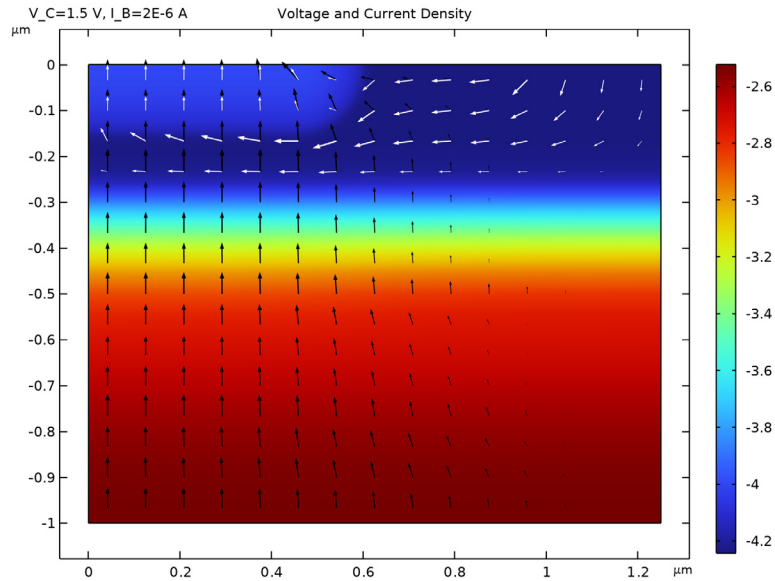



Figure 7: Voltage and current density for $I_B = 2 \mu\text{A}$ and $V_{CE} = 1.5 \text{ V}$. The color shows the voltage and the arrows show the current density for electrons (black) and holes (white). Note that the hole current flows from the base to the emitter and does not enter the lower n-doped region, whilst the electron current flows between the collector and emitter. This current pattern is due to the two p-n junctions which form the device. The electric field is largest around the junctions, as can be seen by the rapid change in voltage between the differently doped regions.

Application Library path: Semiconductor_Module/Transistors/
bipolar_transistor

Modeling Instructions



From the **File** menu, choose **New**.

NEW

In the **New** window, click  **Model Wizard**.

MODEL WIZARD

1 In the **Model Wizard** window, click  **2D**.

- 2 In the **Select Physics** tree, select **Semiconductor > Semiconductor (semi)**.
- 3 Click **Add**.
- 4 Click  **Study**.
- 5 In the **Select Study** tree, select **General Studies > Stationary**.
- 6 Click  **Done**.

GLOBAL DEFINITIONS

Parameters 1

- 1 In the **Model Builder** window, under **Global Definitions** click **Parameters 1**.
- 2 In the **Settings** window for **Parameters**, locate the **Parameters** section.
- 3 Click  **Load from File**.
- 4 Browse to the model's Application Libraries folder and double-click the file `bipolar_transistor_parameters.txt`.

GEOMETRY 1

- 1 In the **Model Builder** window, under **Component 1 (comp1)** click **Geometry 1**.
- 2 In the **Settings** window for **Geometry**, locate the **Units** section.
- 3 From the **Length unit** list, choose μm .

Rectangle 1 (r1)

- 1 In the **Geometry** toolbar, click  **Rectangle**.
- 2 In the **Settings** window for **Rectangle**, locate the **Size and Shape** section.
- 3 In the **Width** text field, type $w_{\text{BJT}}/2$.
- 4 In the **Height** text field, type d_{BJT} .
- 5 Locate the **Position** section. In the **y** text field, type $-d_{\text{BJT}}$.

Define the emitter ohmic contact.

Point 1 (pt1)

- 1 In the **Geometry** toolbar, click  **Point**.
- 2 In the **Settings** window for **Point**, locate the **Point** section.
- 3 In the **x** text field, type w_{cE} .

Define the base ohmic contact.



Point 2 (pt2)

- 1 In the **Geometry** toolbar, click  **Point**.

- 2 In the **Settings** window for **Point**, locate the **Point** section.
- 3 In the **x** text field, type $w_{BJT}/2 - w_{cB}$.
- 4 Click  **Build All Objects**.

Load the semiconductor material properties for silicon.

ADD MATERIAL

- 1 In the **Materials** toolbar, click  **Add Material** to open the **Add Material** window.
- 2 Go to the **Add Material** window.
- 3 In the tree, select **Semiconductors** > **Si - Silicon**.
- 4 Click the **Add to Component** button in the window toolbar.
- 5 In the **Materials** toolbar, click  **Add Material** to close the **Add Material** window.

SEMICONDUCTOR (SEMI)

- 1 In the **Settings** window for **Semiconductor**, locate the **Thickness** section.
- 2 In the d text field, type l_{BJT} .
- 3 Click to expand the **Discretization** section. From the **Formulation** list, choose **Finite element, log formulation (linear shape function)**.

Semiconductor Material Model 1

- 1 In the **Model Builder** window, under **Component 1 (comp1)** > **Semiconductor (semi)** click **Semiconductor Material Model 1**.
- 2 In the **Settings** window for **Semiconductor Material Model**, locate the **Model Input** section.
- 3 In the T text field, type T_0 .

Add the doping profiles. First the epitaxial layer background doping.

Analytic Doping Model 1

- 1 In the **Physics** toolbar, click  **Domains** and choose **Analytic Doping Model**.
- 2 In the **Settings** window for **Analytic Doping Model**, locate the **Domain Selection** section.
- 3 From the **Selection** list, choose **All domains**.
- 4 Locate the **Impurity** section. From the **Impurity type** list, choose **Donor doping (n-type)**.
- 5 In the N_{D0} text field, type N_{epi} .

Analytic Doping Model 2

- 1 In the **Physics** toolbar, click  **Domains** and choose **Analytic Doping Model**.
- 2 In the **Settings** window for **Analytic Doping Model**, locate the **Domain Selection** section.

- 3 From the **Selection** list, choose **All domains**.
- 4 Locate the **Distribution** section. From the list, choose **Box**.
- 5 Locate the **Uniform Region** section. Specify the r_0 vector as

0 [um]	X
-d_E	Y

- 6 In the W text field, type $w_{BJT}/2$.
- 7 In the D text field, type d_E .
- 8 Locate the **Impurity** section. In the N_{A0} text field, type $N_B + N_{epi}$.
- 9 Locate the **Profile** section. In the d_j text field, type d_E .
- 10 From the N_b list, choose **Donor concentration (semi/adm1)**.

Here you can plot the preview of the doping profile for the selected feature.

- 11 Click the **Plot Doping Profile for Selected** button in the window toolbar.

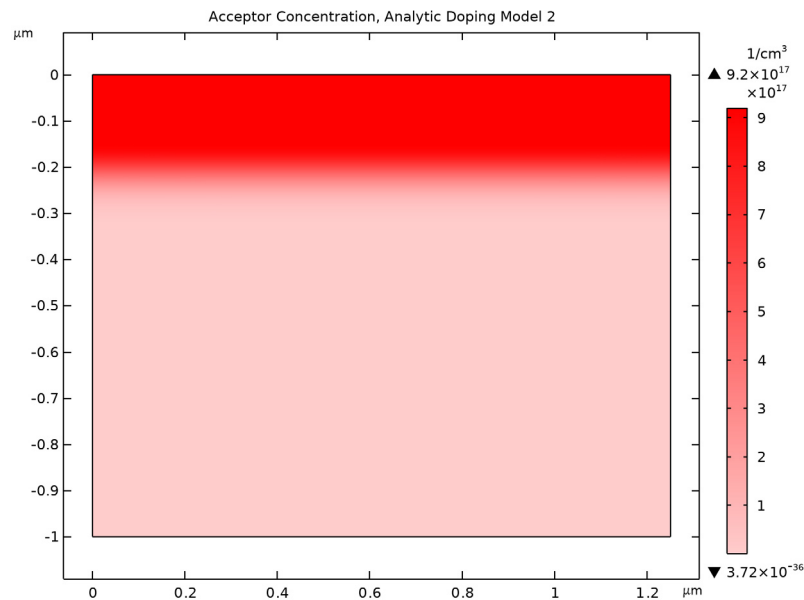

Analytic Doping Model 3

- 1 In the **Physics** toolbar, click **Domains** and choose **Analytic Doping Model**.
- 2 In the **Settings** window for **Analytic Doping Model**, locate the **Domain Selection** section.
- 3 From the **Selection** list, choose **All domains**.

- 4 Locate the **Distribution** section. From the list, choose **Box**.
- 5 Locate the **Uniform Region** section. In the W text field, type $w_E/2 - d_E$.
- 6 Locate the **Impurity** section. From the **Impurity type** list, choose **Donor doping (n-type)**.
- 7 In the N_{D0} text field, type $N_E + N_B$.
- 8 Locate the **Profile** section. In the d_j text field, type d_E .
- 9 In the N_b text field, type N_B .

Analytic Doping Model 4

- 1 In the **Physics** toolbar, click  **Domains** and choose **Analytic Doping Model**.
- 2 In the **Settings** window for **Analytic Doping Model**, locate the **Domain Selection** section.
- 3 From the **Selection** list, choose **All domains**.
- 4 Locate the **Distribution** section. From the list, choose **Box**.
- 5 Locate the **Uniform Region** section. Specify the r_0 vector as

0 [um]	X
$-d_{BJT} - d_C$	Y

- 6 In the W text field, type $w_{BJT}/2$.
- 7 In the D text field, type d_C .
- 8 Locate the **Impurity** section. From the **Impurity type** list, choose **Donor doping (n-type)**.
- 9 In the N_{D0} text field, type N_C .
- 10 Locate the **Profile** section. In the d_j text field, type $1.3 * d_C$.
- 11 From the N_b list, choose **Donor concentration (semi/adm1)**.

Here you can plot the preview of the doping profile for all the features.

12 Click the **Plot Net Doping Profile for All** button in the window toolbar.

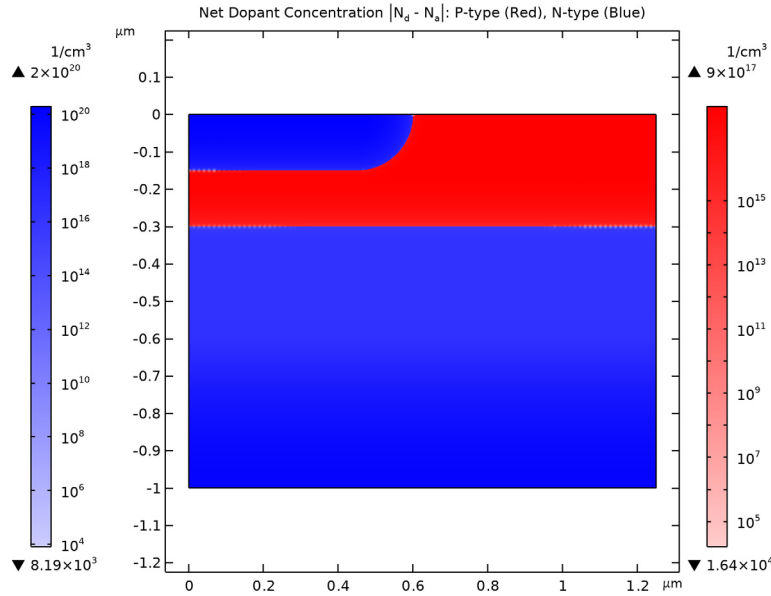

Trap-Assisted Recombination I

- 1 In the **Physics** toolbar, click  **Domains** and choose **Trap-Assisted Recombination**.
- 2 In the **Settings** window for **Trap-Assisted Recombination**, locate the **Domain Selection** section.
- 3 From the **Selection** list, choose **All domains**.

Emitter Voltage

- 1 In the **Physics** toolbar, click  **Boundaries** and choose **Metal Contact**.
- 2 Select Boundary 3 only.
- 3 In the **Settings** window for **Metal Contact**, locate the **Terminal** section.
- 4 In the V_0 text field, type V_E .
- 5 In the **Label** text field, type Emitter Voltage.

Base Voltage

- 1 In the **Physics** toolbar, click  **Boundaries** and choose **Metal Contact**.
- 2 Select Boundary 5 only.
- 3 In the **Settings** window for **Metal Contact**, locate the **Terminal** section.
- 4 In the V_0 text field, type V_B .

5 In the **Label** text field, type Base Voltage.

Collector Voltage

1 In the **Physics** toolbar, click  **Boundaries** and choose **Metal Contact**.

2 Select Boundary 2 only.

3 In the **Settings** window for **Metal Contact**, locate the **Terminal** section.

4 In the V_0 text field, type V_C .

5 In the **Label** text field, type Collector Voltage.

Add an additional boundary condition that specifies the current for the base contact. Depending on the requirements of each study, either the voltage or the current boundary condition will be disabled.

Base Current

1 In the **Model Builder** window, right-click **Base Voltage** and choose **Duplicate**.

2 In the **Settings** window for **Metal Contact**, type Base Current in the **Label** text field.

3 Locate the **Terminal** section. From the **Terminal type** list, choose **Current**.

4 In the I_0 text field, type I_B .

MESH 1

1 In the **Model Builder** window, under **Component 1 (comp1)** click **Mesh 1**.

2 In the **Settings** window for **Mesh**, locate the **Sequence Type** section.

3 From the list, choose **User-controlled mesh**.

Size 1

In the **Model Builder** window, under **Component 1 (comp1)** > **Mesh 1** right-click **Size 1** and choose **Delete**.

Free Triangular 1

Right-click **Free Triangular 1** and choose **Delete**.

Edge 1

1 In the **Mesh** toolbar, click  **More Generators** and choose **Edge**.

2 Select Boundaries 3–5 only.

Distribution 1

1 Right-click **Edge 1** and choose **Distribution**.

2 In the **Settings** window for **Distribution**, locate the **Distribution** section.

3 From the **Distribution type** list, choose **Predefined**.

- 4 In the **Number of elements** text field, type 40.
- 5 In the **Element ratio** text field, type 5.
- 6 Select the **Symmetric distribution** checkbox.

Copy Edge 1

- 1 In the **Model Builder** window, right-click **Mesh 1** and choose **Copying Operations > Copy Edge**.
- 2 Select Boundaries 3–5 only.
- 3 In the **Settings** window for **Copy Edge**, locate the **Destination Boundaries** section.
- 4 Click to select the  **Activate Selection** toggle button.
- 5 Select Boundary 2 only.

Mapped 1

In the **Mesh** toolbar, click  **Mapped**.

Distribution 1

- 1 Right-click **Mapped 1** and choose **Distribution**.
- 2 Select Boundaries 1 and 6 only.
- 3 In the **Settings** window for **Distribution**, locate the **Distribution** section.
- 4 From the **Distribution type** list, choose **Predefined**.
- 5 In the **Number of elements** text field, type 100.
- 6 In the **Element ratio** text field, type 100.
- 7 From the **Growth rate** list, choose **Exponential**.
- 8 Select the **Symmetric distribution** checkbox.

9 Click  **Build All**.

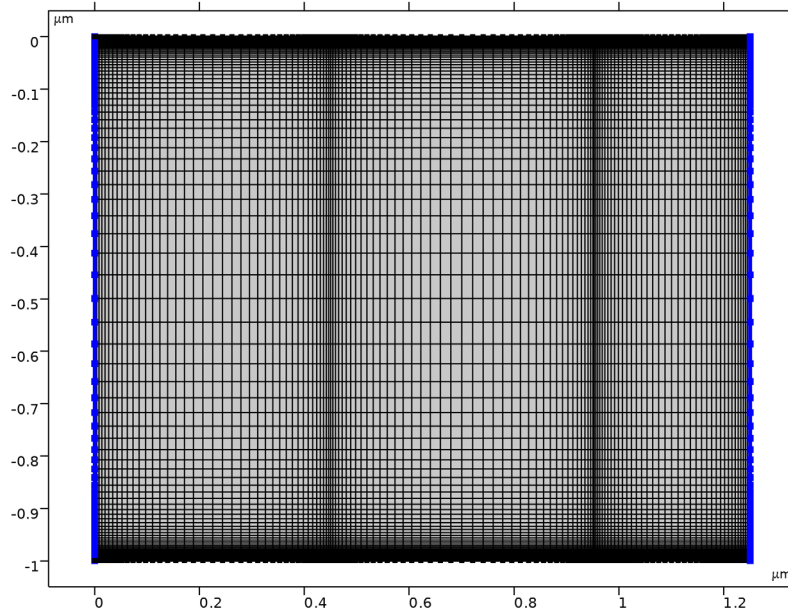

First, perform a Stationary Study to sweep the collector voltage. The solution will be used as initial values by the next study.

V_C SWEEP, V_B=0 V, V_E=0 V

- 1 In the **Model Builder** window, click **Study I**.
- 2 In the **Settings** window for **Study**, type V_C Sweep, V_B=0 V, V_E=0 V in the **Label** text field.
- 3 Locate the **Study Settings** section. Clear the **Generate default plots** checkbox.

Step 1: Stationary

- 1 In the **Model Builder** window, under **V_C Sweep, V_B=0 V, V_E=0 V** click **Step 1: Stationary**.
- 2 In the **Settings** window for **Stationary**, locate the **Physics and Variables Selection** section.
- 3 Select the **Modify model configuration for study step** checkbox.
- 4 In the tree, select **Component 1 (comp1) > Semiconductor (semi) > Base Current**.
- 5 Right-click and choose **Disable**.
- 6 Click to expand the **Study Extensions** section. Select the **Auxiliary sweep** checkbox.
- 7 From the **Sweep type** list, choose **All combinations**.

8 Click  **Add**.

9 In the table, enter the following settings:

Parameter name	Parameter value list	Parameter unit
V_B (Applied voltage: base)	0	V

10 Click  **Add**.

11 In the table, enter the following settings:

Parameter name	Parameter value list	Parameter unit
V_E (Applied voltage: emitter)	0	V

12 Click  **Add**.



13 In the table, enter the following settings:

Parameter name	Parameter value list	Parameter unit
V_C (Applied voltage: collector)	range (0,0.1,0.5)	V

14 In the **Study** toolbar, click  **Compute**.

Next, add a Stationary Study to perform a sweep of the base voltage.

ADD STUDY

- 1 In the **Study** toolbar, click  **Add Study** to open the **Add Study** window.
- 2 Go to the **Add Study** window.
- 3 Find the **Studies** subsection. In the **Select Study** tree, select **General Studies > Stationary**.
- 4 Click the **Add Study** button in the window toolbar.
- 5 In the **Study** toolbar, click  **Add Study** to close the **Add Study** window.

V_B SWEEP, V_C=0.5 V, V_E=0 V

- 1 In the **Settings** window for **Study**, type V_B Sweep, V_C=0.5 V, V_E=0 V in the **Label** text field.
- 2 Locate the **Study Settings** section. Clear the **Generate default plots** checkbox.

Define the sweep for the full base voltage (V_B) study.

- 1 In the **Model Builder** window, under **V_B Sweep, V_C=0.5 V, V_E=0 V** click **Step 1: Stationary**.
- 2 In the **Settings** window for **Stationary**, locate the **Physics and Variables Selection** section.

- 3 Select the **Modify model configuration for study step** checkbox.
- 4 In the tree, select **Component 1 (comp1) > Semiconductor (semi) > Base Current**.
- 5 Right-click and choose **Disable**.
- 6 Click to expand the **Values of Dependent Variables** section. Find the **Initial values of variables solved for** subsection. From the **Settings** list, choose **User controlled**.
- 7 From the **Method** list, choose **Solution**.
- 8 From the **Study** list, choose **V_C Sweep, V_B=0 V, V_E=0 V, Stationary**.
- 9 From the **Parameter value (V_C (V), V_B (V), V_E (V))** list, choose **Last**.
- 10 Locate the **Study Extensions** section. Select the **Auxiliary sweep** checkbox.
- 11 Click **+ Add**.
- 12 In the table, enter the following settings:

Parameter name	Parameter value list	Parameter unit
V_B (Applied voltage: base)	range(0, 0.025, 1.1)	V

- 13 In the **Study** toolbar, click **= Compute**.

Plot the current at each terminal as a function of the base voltage (V_B). Note that currents which flow from the contact into the semiconductor have positive sign and those which flow from the semiconductor into a contact have negative sign.

RESULTS

I_E, I_B and I_C as a function of V_BE

- 1 In the **Results** toolbar, click **~ ID Plot Group**.
- 2 In the **Settings** window for **ID Plot Group**, type I_E, I_B and I_C as a function of V_BE in the **Label** text field.
- 3 Locate the **Data** section. From the **Dataset** list, choose **V_B Sweep, V_C=0.5 V, V_E=0 V / Solution 2 (sol2)**.

Global I

- 1 Right-click **I_E, I_B and I_C as a function of V_BE** and choose **Global**.
- 2 In the **Settings** window for **Global**, click **Replace Expression** in the upper-right corner of the **y-Axis Data** section. From the menu, choose **Component 1 (comp1) > Semiconductor > Terminals > semi.I0_I - Terminal current - A**.

- 3 Click **Add Expression** in the upper-right corner of the **y-Axis Data** section. From the menu, choose **Component I (compl) > Semiconductor > Terminals > semi.IO_2 - Terminal current - A**.
- 4 Click **Add Expression** in the upper-right corner of the **y-Axis Data** section. From the menu, choose **Component I (compl) > Semiconductor > Terminals > semi.IO_3 - Terminal current - A**.
- 5 Locate the **y-Axis Data** section. In the table, enter the following settings:

Expression	Unit	Description
semi.IO_1	mA	I_E
semi.IO_2	mA	I_B
semi.IO_3	mA	I_C

- 6 In the **I_E, I_B and I_C as a function of V_BE** toolbar, click  **Plot**.

The current is conserved. To see this, add a plot of $I_B = -(I_E + I_C)$ to the graph, which, due to the software sign convention, corresponds with emitter current being equal to the sum of the base and collector currents.

Global 2

- 1 In the **Model Builder** window, right-click **I_E, I_B and I_C as a function of V_BE** and choose **Global**.
- 2 In the **Settings** window for **Global**, locate the **y-Axis Data** section.
- 3 In the table, enter the following settings:

Expression	Unit	Description
-(semi.IO_1+semi.IO_3)	mA	I_B calc

- 4 Click to expand the **Coloring and Style** section. Find the **Line style** subsection. From the **Line** list, choose **None**.
- 5 From the **Color** list, choose **Magenta**.
- 6 Find the **Line markers** subsection. From the **Marker** list, choose **Circle**.
- 7 From the **Positioning** list, choose **Interpolated**.
- 8 In the **Number** text field, type 30.

I_E, I_B and I_C as a function of V_BE

- 1 In the **Model Builder** window, click **I_E, I_B and I_C as a function of V_BE**.
- 2 In the **Settings** window for **ID Plot Group**, click to expand the **Title** section.
- 3 From the **Title type** list, choose **None**.

- 4 Locate the **Plot Settings** section.
- 5 Select the **x-axis label** checkbox. In the associated text field, type V_{BE} (V).
- 6 Select the **y-axis label** checkbox. In the associated text field, type I (mA).
- 7 Locate the **Legend** section. From the **Position** list, choose **Lower left**.
- 8 In the **I_E , I_B and I_C as a function of V_{BE}** toolbar, click  **Plot**.

Plot the collector and base currents as a function of the base-emitter voltage. This kind of plot is known as a Gummel plot, and is useful in device characterization.

Gummel Plot, I_C and I_B as a function of V_{BE}

- 1 In the **Results** toolbar, click  **ID Plot Group**.
- 2 In the **Settings** window for **ID Plot Group**, type Gummel Plot, I_C and I_B as a function of V_{BE} in the **Label** text field.
- 3 Locate the **Data** section. From the **Dataset** list, choose **V_B Sweep, $V_C=0.5$ V, $V_E=0$ V / Solution 2 (sol2)**.

Global I

- 1 Right-click **Gummel Plot, I_C and I_B as a function of V_{BE}** and choose **Global**.
- 2 In the **Settings** window for **Global**, locate the **y-Axis Data** section.
- 3 In the table, enter the following settings:

Expression	Unit	Description
abs(semi.I0_3)	A	Collector Current, I_C
abs(semi.I0_2)	A	Base Current, I_B

Gummel Plot, I_C and I_B as a function of V_{BE}

- 1 In the **Model Builder** window, click **Gummel Plot, I_C and I_B as a function of V_{BE}** .
- 2 In the **Settings** window for **ID Plot Group**, locate the **Title** section.
- 3 From the **Title type** list, choose **Manual**.
- 4 In the **Title** text area, type Gummel Plot.
- 5 Locate the **Plot Settings** section.
- 6 Select the **x-axis label** checkbox. In the associated text field, type Base Voltage (V).
- 7 Select the **y-axis label** checkbox. In the associated text field, type Current (A).
- 8 Locate the **Legend** section. From the **Position** list, choose **Upper left**.
- 9 Click the  **y-Axis Log Scale** button in the **Graphics** toolbar.
Restrict the data range to exclude very small current values.

- 10 Locate the **Data** section. From the **Parameter selection (V_B)** list, choose **Manual**.
- 11 In the **Parameter indices (I-45)** text field, type range (17, 1, 45).
- 12 In the **Gummel Plot, I_C and I_B as a function of V_BE** toolbar, click  **Plot**.

Another useful characterization quantity is the DC current gain curve, which is the ratio of the collector to base current (I_C/I_B) as a function of collector current.

Current Gain

- 1 In the **Results** toolbar, click  **ID Plot Group**.
- 2 In the **Settings** window for **ID Plot Group**, type Current Gain in the **Label** text field.
- 3 Locate the **Data** section. From the **Dataset** list, choose **V_B Sweep, V_C=0.5 V, V_E=0 V / Solution 2 (sol2)**.
- 4 Locate the **Axis** section. Select the **x-axis log scale** checkbox.

Global I

- 1 Right-click **Current Gain** and choose **Global**.
- 2 In the **Settings** window for **Global**, locate the **y-Axis Data** section.
- 3 In the table, enter the following settings:

Expression	Unit	Description
<code>abs(semi.I0_3/semi.I0_2)</code>	1	Gain (I_C/I_B)

- 4 Locate the **x-Axis Data** section. From the **Parameter** list, choose **Expression**.
- 5 In the **Expression** text field, type `semi.I0_3`.

Current Gain

- 1 In the **Model Builder** window, click **Current Gain**.
- 2 In the **Settings** window for **ID Plot Group**, locate the **Plot Settings** section.
- 3 Select the **x-axis label** checkbox. In the associated text field, type Collector current (A).
- 4 Select the **y-axis label** checkbox. In the associated text field, type Current gain. Restrict the data range to exclude very small current values.
- 5 Locate the **Data** section. From the **Parameter selection (V_B)** list, choose **Manual**.
- 6 In the **Parameter indices (I-45)** text field, type range (17, 1, 45).
- 7 In the **Current Gain** toolbar, click  **Plot**.

The collector current as a function of the collector voltage can be controlled by applying a base current. In this way, the output characteristics of the device can be controlled by an

input current from, say, a sensing circuit. This effect can be seen by plotting the collector current as a function of the collector voltage for two different values of the base current.



As the required studies are current driven it is helpful to provide good initial values.

SEMICONDUCTOR (SEMI)

Base Current

- 1 In the **Model Builder** window, under **Component 1 (comp1) > Semiconductor (semi)** click **Base Current**.
- 2 In the **Settings** window for **Metal Contact**, locate the **Terminal** section.
- 3 In the V_{init} text field, type 0.8[V].

ADD STUDY

- 1 In the **Home** toolbar, click  **Add Study** to open the **Add Study** window.
- 2 Go to the **Add Study** window.
- 3 Find the **Studies** subsection. In the **Select Study** tree, select **General Studies > Stationary**.
- 4 Click the **Add Study** button in the window toolbar.
- 5 In the **Home** toolbar, click  **Add Study** to close the **Add Study** window.

V_C SWEEP, V_E=0 V, FOR I_B=2[UA]

- 1 In the **Settings** window for **Study**, type V_C Sweep, V_E=0 V, for I_B=2[uA] in the **Label** text field.
- 2 Locate the **Study Settings** section. Clear the **Generate default plots** checkbox.

Step 1: Stationary

- 1 In the **Model Builder** window, under **V_C Sweep, V_E=0 V, for I_B=2[uA]** click **Step 1: Stationary**.
- 2 In the **Settings** window for **Stationary**, locate the **Values of Dependent Variables** section.
- 3 Find the **Initial values of variables solved for** subsection. From the **Settings** list, choose **User controlled**.
- 4 From the **Method** list, choose **Solution**.
- 5 From the **Study** list, choose **V_B Sweep, V_C=0.5 V, V_E=0 V, Stationary**.
- 6 From the **Parameter value (V_B (V))** list, choose **0.85 V**.
- 7 Locate the **Study Extensions** section. Select the **Auxiliary sweep** checkbox.
- 8 From the **Sweep type** list, choose **All combinations**.
- 9 Click **+ Add**.

10 In the table, enter the following settings:

Parameter name	Parameter value list	Parameter unit
I_B (Inward applied current: base)	2 [uA]	A

11 Click  **Add**.

12 In the table, enter the following settings:



Parameter name	Parameter value list	Parameter unit
V_C (Applied voltage: collector)	range (0, 0.05, 0.4) range (0.5, 0.1, 1.5)	V

13 In the **Study** toolbar, click  **Compute**.

To investigate the effect that a larger base current has on the response of the collector current to the collector voltage sweep a similar study will be performed with a base current of 10 uA.

The study is the same as the previous one, but the base current (I_B) is set to a value of 10 uA instead of 2 uA.

ADD STUDY

- 1 In the **Study** toolbar, click  **Add Study** to open the **Add Study** window.
- 2 Go to the **Add Study** window.
- 3 Find the **Studies** subsection. In the **Select Study** tree, select **Empty Study**.
- 4 Click the **Add Study** button in the window toolbar.
- 5 In the **Study** toolbar, click  **Add Study** to close the **Add Study** window.

V_C SWEEP, V_E=0 V, FOR I_B=10 [UA]

- 1 In the **Settings** window for **Study**, locate the **Study Settings** section.
- 2 Clear the **Generate default plots** checkbox.
- 3 In the **Label** text field, type V_C Sweep, V_E=0 V, for I_B=10[uA].

V_C SWEEP, V_E=0 V, FOR I_B=2 [UA]

Right-click **Step 1: Stationary** and choose **Copy**.

V_C SWEEP, V_E=0 V, FOR I_B=10 [UA]

In the **Model Builder** window, right-click **V_C Sweep, V_E=0 V, for I_B=10[uA]** and choose **Paste Stationary**.

1 In the **Settings** window for **Stationary**, locate the **Study Extensions** section.

2 In the table, enter the following settings:

Parameter name	Parameter value list	Parameter unit
I_B (Inward applied current: base)	10 [uA]	A

3 In the **Study** toolbar, click  **Compute**.

Plotting both curves on the same graph allows for direct comparison.

RESULTS

Common-emitter output characteristics

1 In the **Results** toolbar, click  **ID Plot Group**.

2 In the **Settings** window for **ID Plot Group**, type Common-emitter output characteristics in the **Label** text field.

Global 1

1 Right-click **Common-emitter output characteristics** and choose **Global**.

2 In the **Settings** window for **Global**, locate the **Data** section.

3 From the **Dataset** list, choose **V_C Sweep, V_E=0 V, for I_B=2[uA]/Solution 3 (sol3)**.

4 Locate the **y-Axis Data** section. In the table, enter the following settings:

Expression	Unit	Description
abs(semi.I0_3)	uA	Collector Current I_B=2uA

5 Click to expand the **Legends** section. From the **Legends** list, choose **Manual**.

6 In the table, enter the following settings:

Legends
I_B=2 uA

Global 2

1 In the **Model Builder** window, right-click **Common-emitter output characteristics** and choose **Global**.

2 In the **Settings** window for **Global**, locate the **Data** section.

3 From the **Dataset** list, choose **V_C Sweep, V_E=0 V, for I_B=10[uA]/Solution 4 (sol4)**.

4 Locate the **y-Axis Data** section. In the table, enter the following settings:

Expression	Unit	Description
abs(semi.I0_3)	uA	Collector Current I _B =10 uA

5 Locate the **Legends** section. From the **Legends** list, choose **Manual**.

6 In the table, enter the following settings:

Legends
I _B =10 uA

Common-emitter output characteristics

- 1 In the **Model Builder** window, click **Common-emitter output characteristics**.
- 2 In the **Settings** window for **ID Plot Group**, locate the **Title** section.
- 3 From the **Title type** list, choose **Manual**.
- 4 In the **Title** text area, type Collector Current as a function of Collector Voltage.
- 5 Locate the **Plot Settings** section.
- 6 Select the **x-axis label** checkbox. In the associated text field, type Collector Voltage (V).
- 7 Select the **y-axis label** checkbox. In the associated text field, type Collector Current (uA).
- 8 Locate the **Legend** section. From the **Position** list, choose **Middle right**.
- 9 In the **Common-emitter output characteristics** toolbar, click  **Plot**.

Finally, the current density for each kind of carrier can be visualized using a 2D arrow plot.

Voltage & Current Density

- 1 In the **Results** toolbar, click  **2D Plot Group**.
- 2 In the **Settings** window for **2D Plot Group**, type Voltage & Current Density in the **Label** text field.
- 3 Locate the **Data** section. From the **Dataset** list, choose **V_C Sweep, V_E=0 V, for I_B=2[uA]/Solution 3 (sol3)**.

Surface I

- 1 Right-click **Voltage & Current Density** and choose **Surface**.
- 2 In the **Settings** window for **Surface**, locate the **Expression** section.
- 3 In the **Expression** text field, type V.

- 4 Click to expand the **Quality** section. From the **Evaluation settings** list, choose **Manual**.
- 5 From the **Resolution** list, choose **No refinement**.
- 6 From the **Smoothing** list, choose **Everywhere**.
- 7 In the **Voltage & Current Density** toolbar, click  **Plot**.



Arrow Surface 1

- 1 In the **Model Builder** window, right-click **Voltage & Current Density** and choose **Arrow Surface**.
- 2 In the **Settings** window for **Arrow Surface**, click **Replace Expression** in the upper-right corner of the **Expression** section. From the menu, choose **Component 1 (comp1) > Semiconductor > Currents and charge > Electron current > semi.JnX,semi.JnY - Electron current density**.
- 3 Locate the **Coloring and Style** section. From the **Arrow length** list, choose **Logarithmic**.
- 4 From the **Color** list, choose **Black**.

Arrow Surface 2

- 1 Right-click **Arrow Surface 1** and choose **Duplicate**.
- 2 In the **Settings** window for **Arrow Surface**, locate the **Expression** section.
- 3 In the **X-component** text field, type `semi.JpX`.
- 4 In the **Y-component** text field, type `semi.JpY`.
- 5 Locate the **Coloring and Style** section. From the **Color** list, choose **White**.

Voltage & Current Density

- 1 In the **Model Builder** window, click **Voltage & Current Density**.
- 2 In the **Settings** window for **2D Plot Group**, click to expand the **Title** section.
- 3 From the **Title type** list, choose **Manual**.
- 4 In the **Title** text area, type `Voltage and Current Density`.
- 5 In the **Voltage & Current Density** toolbar, click  **Plot**.
- 6 Click the  **Zoom Extents** button in the **Graphics** toolbar.

The value of V_C for which the final plot group is plotted can be changed in order to investigate the operation of the bipolar transistor. To do this, click on **Voltage and Current Density** in the Model Builder, locate the **Data** section of the 2D plot group panel and change the value of **Parameter value (V_C)**.

At $V_C = 0$ V the electron and hole currents flow in unison from the base contact to both the collector and emitter contacts. This is expected, as the device is being driven

by a base current. The net collector current is very small as the electron and hole currents are nearly balanced.

At $V_C = 1.5\text{ V}$ the device is operating in the saturation regime. The hole current flows mainly from the base to the emitter and the electron current flows mainly from the collector to the emitter. This results in a large net current at the collector contact.