



Model created in COMSOL Multiphysics 6.4

Modeling Vibration and Noise in a Gearbox: Bearing Version

Introduction

This example is an extension of the model *Modeling Vibration and Noise in a Gearbox* included in the Acoustics Module and Multibody Dynamics Module Application Libraries. In this version of the model, a detailed representation of the roller bearings is used instead of a hinge joint to connect the shafts with the housing. Due to the finite stiffness of the bearings, the vibration response of the system can be significantly different from that obtained using the rigid bearing assumption. An accurate prediction of the vibration and noise radiation from a dynamic system, like a gearbox, can help designers do the necessary design modifications at an early stage.

The noise in a gearbox can be generated due to various reasons. The first and foremost is the transmission of undesired lateral and axial forces on the bearings and housing due to the gear contact. The interaction of bearings with the housing while transmitting the forces can also lead to significant vibrations in the system.

A 5-speed synchromesh gearbox of a manual transmission vehicle is considered in this model. First, the gearbox vibration is computed using a time-dependent analysis for the specified engine speed and external load. The normal acceleration of the gearbox housing is converted to the frequency domain and used as a source of noise. Finally, an acoustic analysis is performed to obtain the sound pressure levels in the near, far, and exterior fields.

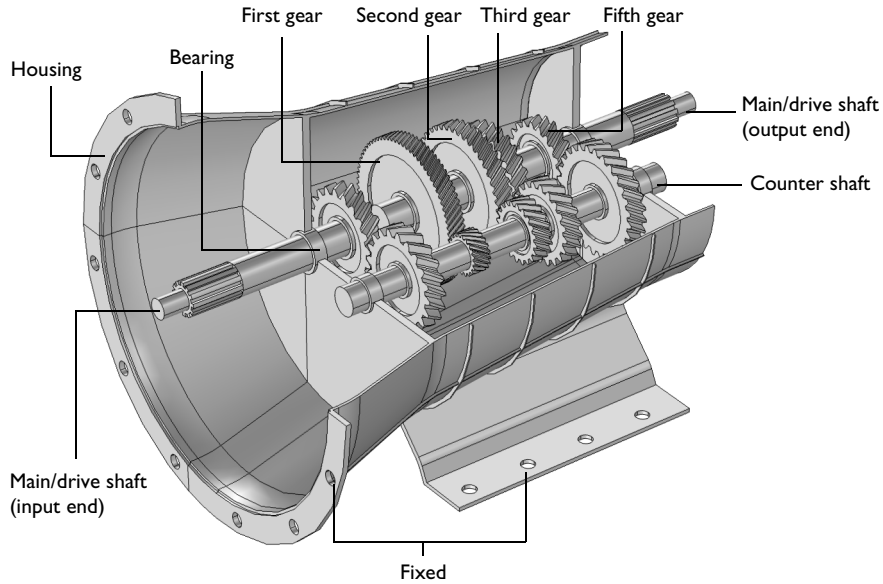

Figure 1: The modeled geometry of a 5-speed synchromesh gearbox of a manual transmission vehicle.

The geometry of a synchromesh gearbox is shown in [Figure 1](#). Only those parts of the gearbox which are relevant from a physics point of view are considered for the analysis.

A varying gear mesh stiffness and the interaction of the bearings with the shafts and housing produce vibrations in the whole gear box assembly. These vibrations are transmitted to the housing that further transmits the energy to the surrounding fluid, resulting in radiation of acoustic waves. In order to numerically simulate this entire phenomenon, the following analyses are performed:

- **Multibody Analysis.** The first step is to perform multibody analysis of a gearbox in order to compute the dynamics of the gears and the vibration of the housing. The multibody analysis is performed in the time domain at the specified engine speed and output torque.
- **Acoustics Analysis.** As a next step, a spherical domain enclosing the gearbox housing is created in order to perform an acoustics analysis to compute the sound pressure levels

outside the gearbox. The normal acceleration computed on the housing in the multibody analysis is used as a source of noise for the acoustic analysis.

PART I: MULTIBODY ANALYSIS

The gear arrangement in the synchromesh gearbox is shown below in [Figure 2](#).

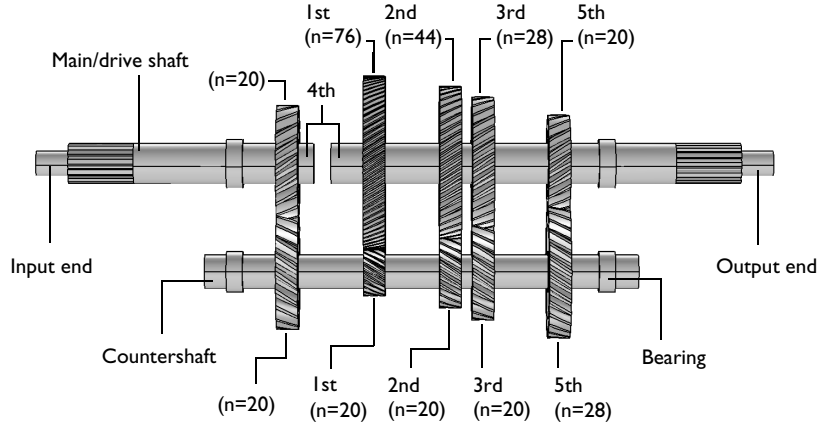

Figure 2: Gear arrangement in the 5-speed synchromesh gearbox. The synchronizing rings used to connect the gears with the main shaft are not physically modeled here.

The gearbox considered here has its main, or drive shaft, connected to the countershaft using helical gears. The multibody analysis is performed in the time domain for one full revolution of the drive shaft.

Gears

All gears are modeled as rigid bodies, however, the gear meshing is considered to be elastic. Information about the number of teeth in different gears and their connection is given in [Figure 2](#). Other gear properties are given in the table below:

TABLE 1: GEAR PROPERTIES.

Properties		
Pressure angle	α	25°
Helix angle	β	30°
Gear mesh stiffness	k_t	10^8 N/m

TABLE I: GEAR PROPERTIES.

Properties		
Contact ratio	c_r	1.25
Engaged gear	n	5

Gears mounted on the countershaft are fixed so that they all rotate with the shaft. In contrast, gears mounted on the drive shaft are, in general, free to rotate around its axis, but through synchronizing rings one of them can be engaged with the shaft. In this model, the synchronizing rings are not physically modeled. Instead, constraints are used to engage the gears with the drive shaft.

Shafts

Both shafts are modeled as rigid bodies. At the input end, the drive shaft is connected to the countershaft, and the countershaft is then connected to the drive shaft at the output end. Engaging the fourth gear is special — the input end of the drive shaft is directly connected to the output end of the same, thus bypassing the countershaft. In this case, the gear ratio is unity.

Housing

Both shafts are rested on the housing through roller bearings. The housing is modeled as a flexible body made of structural steel. It is mounted on the ground as well as connected to the engine at one of its ends.

Note: To reduce the computation time, linear elements are used for modeling the displacement of the housing. To get more accurate results, quadratic elements can be used.

Constraints and Loads

- The input end of the drive shaft, which is connected to the engine, is driven at a speed of 800 rpm.
- An external torque/load of 1000 Nm is applied at the output end of the drive shaft.

PART 2: ACOUSTICS ANALYSIS

Unidirectional Coupling

The coupling between the multibody/structural and acoustics physics can be considered as a unidirectional coupling if the exterior fluid is air (or any other light fluid). In this

model, vibrations in the housing affects the surrounding fluid, but the influence of the acoustic pressure is neglected when computing the structural vibrations.

Time to Frequency FFT

The acoustic response in the model is obtained in frequency domain. Therefore, the FFT solver is used to convert the accelerations of the housing obtained from the multibody analysis to the frequency domain.

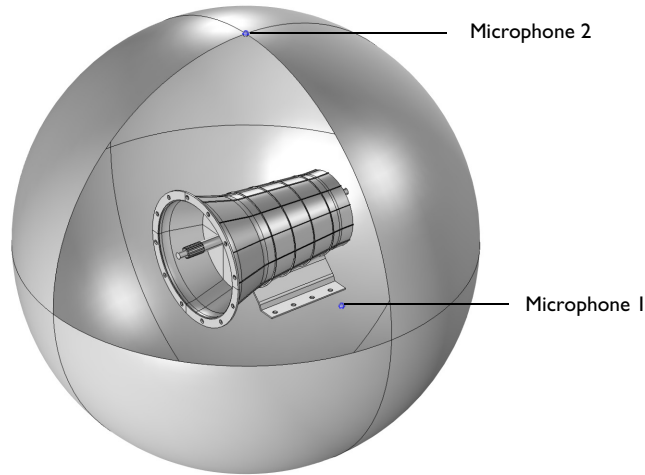

Figure 3: The air domain surrounding the gearbox used in the acoustics analysis. The two microphone locations are also shown.

Domain Equations

This model solves the problem in the frequency domain using the Pressure Acoustics, Frequency Domain interface. The model equation is a slightly modified version of the Helmholtz equation for the acoustic pressure p

$$\nabla \cdot \left(-\frac{\nabla p}{\rho} \right) - \frac{\omega^2 p}{c^2 \rho} = 0$$

where ρ is the density, c is the speed of sound, and ω is the angular frequency.

Note: To reduce the computation time, linear elements are used for the pressure field. To get more accurate results, quadratic elements can be used.

Boundary Conditions

The following boundary conditions are applied in the acoustic domain:

- Normal acceleration of the gearbox housing is applied on the interior boundaries of the acoustics domain.

$$-\mathbf{n} \cdot \left\langle -\frac{\nabla p}{\rho} \right\rangle = a_n$$

where a_n is the normal acceleration. The normal acceleration is applied only on those boundaries of the gearbox which are exposed to the air.

- A spherical wave radiation condition is applied on the exterior boundaries of the acoustic domain.
- A far-field calculation is added to the exterior boundaries of the acoustic domain to compute the sound pressure levels in the far field.

Model Parameters

The acoustic domain consists of air in the atmosphere. The following parameters are used in the model:

- The excitation frequency band is taken from 1000 Hz to 3000 Hz in the steps of 20 Hz
- The size of the enclosing sphere is 0.75 m

Frequency to Time FFT

After solving the acoustics problem for a range of frequencies, the results are transformed into the time domain using the FFT solver in order to visualize the transient wave propagation in the surroundings of the gearbox.

Sound Generation

The pressure data obtained at any location from the frequency domain acoustics analysis can be converted into a sound file with the help of a Model Method. This method requires the magnitude and phase of the pressure as a function of frequency to convert it into a sound file, which can be played by using any sound player.

Two microphones, as shown in [Figure 3](#), are added at the following locations:

- Microphone 1: Side of the gearbox (0, -0.5 m, 0)
- Microphone 2: Top of the gearbox (0, 0, 0.75 m)

These are the default locations defined in the **Parameters** node, but they can be changed as per the requirements.

Results and Discussion

A time domain multibody analysis is performed for one revolution of the main shaft. The von Mises stress distribution in the housing at a particular instant is shown in [Figure 4](#). The speed of different gears can also be seen in the figure.

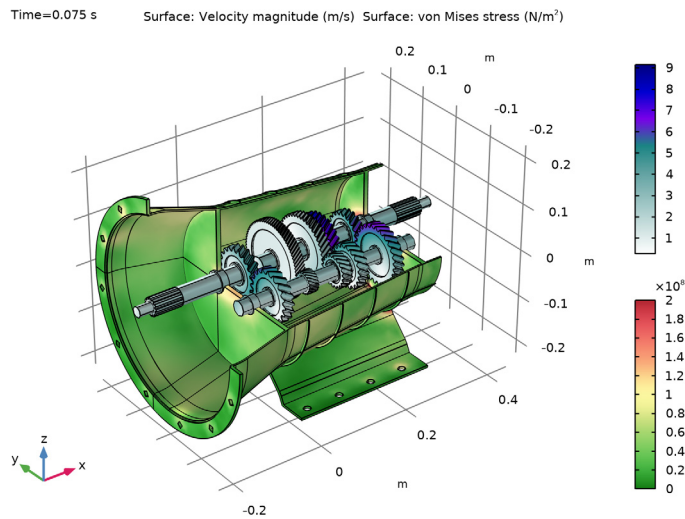

Figure 4: Distribution of von Mises stress in the housing at $t = 0.075$ s. The speed of different gears is also shown.

The gearbox vibrates under the influence of various forces during its operation. The normal acceleration of the housing, a measure of the noise radiation, is shown in [Figure 5](#). To understand the time variation of the acceleration we can choose any point on the housing surface. The time history of the normal acceleration at one of the points near the top of the gearbox is shown in [Figure 6](#). In this figure, the normal acceleration is plotted with the rotation of the main shaft.

In order to get a better understanding about the frequency content, we can transform these results to the frequency domain by using the FFT solver as shown in [Figure 7](#). It is clear from the plot that normal acceleration of the housing contains many frequencies. The frequency band in which the vibration of the housing is dominant is 1500 Hz to 3500 Hz.

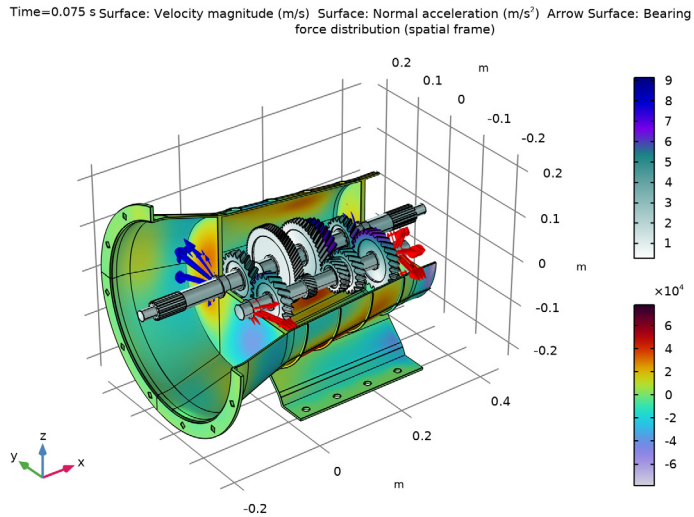

Figure 5: Normal acceleration of the housing at $t = 0.075$ s. The speed of the different gears is also shown. The arrows represent the force distribution in the bearings.

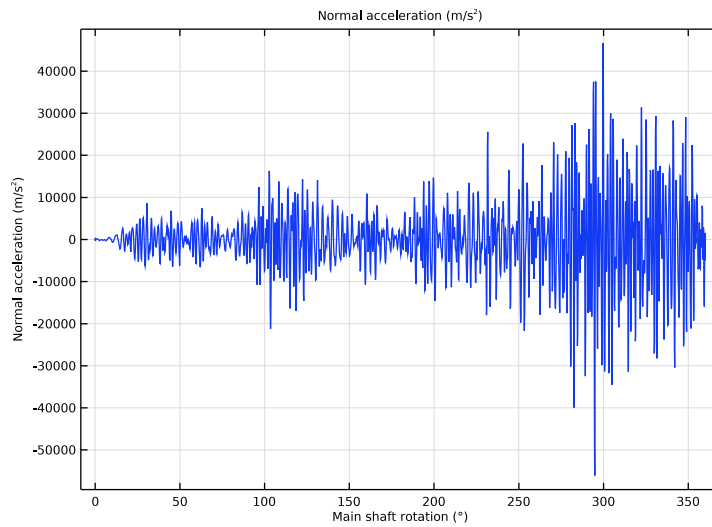

Figure 6: Time history of the normal acceleration at one of the points at the top of the gearbox.

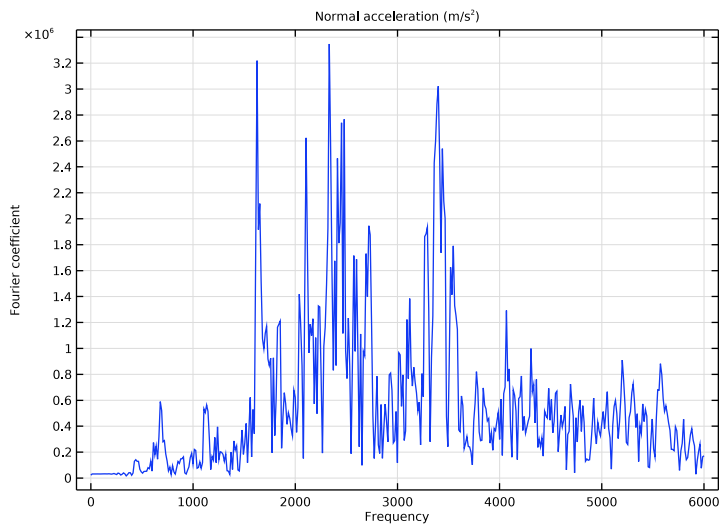

Figure 7: Frequency spectrum of the normal acceleration at one of the points at the top of the gearbox.

The sound pressure level in the near field and on the surface of the gearbox housing is shown in Figure 8 and Figure 9, respectively. The far-field sound pressure level in different planes can be seen in Figure 10, Figure 11, and Figure 12. The far-field plots of the sound pressure level give a clear idea about the directivity of the noise radiation at a particular frequency.

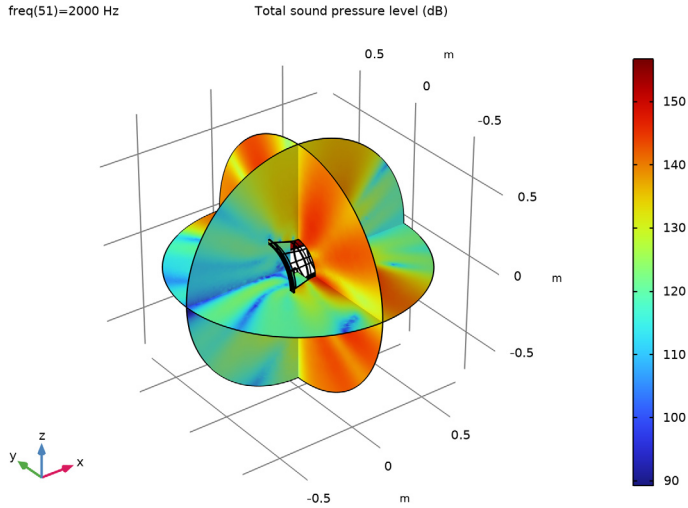

Figure 8: Sound pressure level outside the gearbox at 2000 Hz.

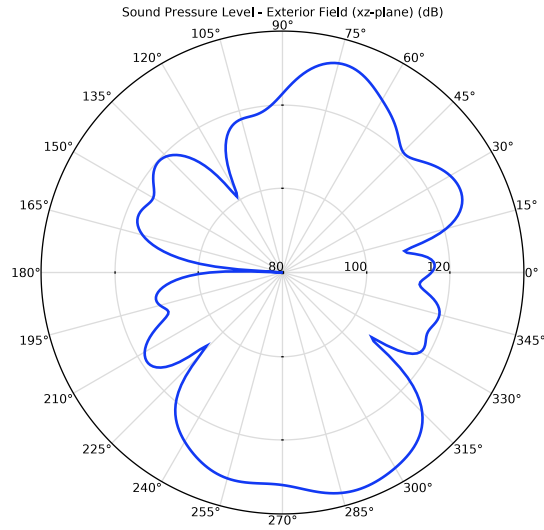

Figure 11: Far-field sound pressure level at a distance of 1m in the xz -plane at 2000 Hz.

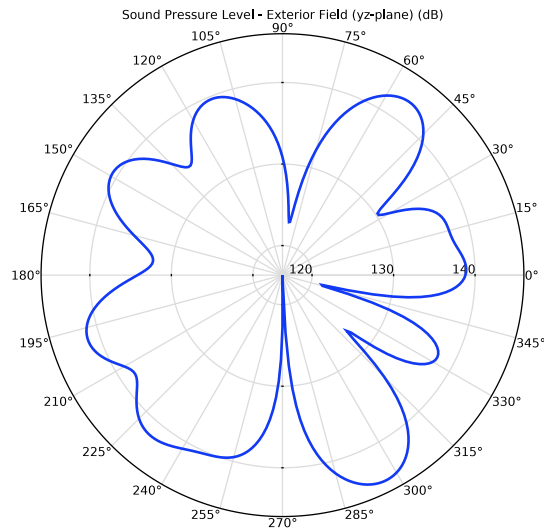

Figure 12: Far-field sound pressure level at a distance of 1m in the yz -plane at 2000 Hz.

The pressure magnitude as a function of frequency at two microphone locations is shown in Figure 13. At microphone 1, the pressure magnitude is higher than at microphone 2 as it is closer to the source of the noise.

In order to visualize the pressure wave propagation in the air outside the gearbox, the frequency domain pressure data can be converted back to the time domain. The pressure field at a particular instance in time is shown in Figure 14.

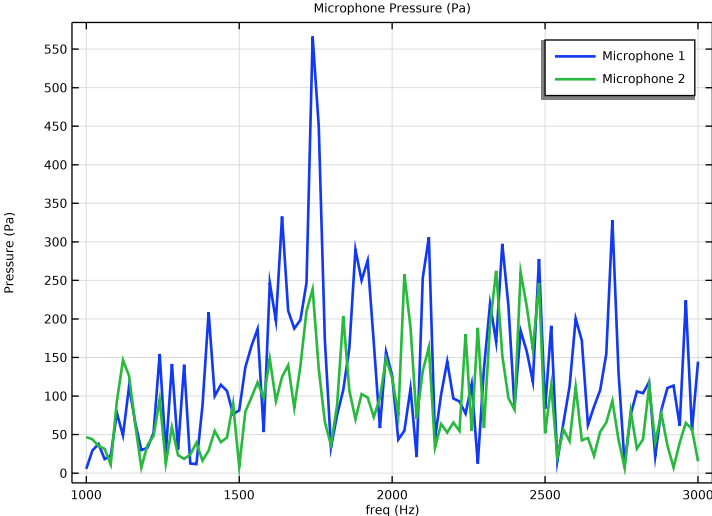

Figure 13: Frequency spectrum of the pressure magnitude at two microphone locations.

- The **Parameters** node under Results is used for defining the location of the microphones. This way, the microphone locations can be changed without updating the solution.
- A Model Method is used to write a code that converts the pressure data into a sound file that can be played to listen to the gearbox noise at different locations.

Note: Model methods can only be set up in the COMSOL Desktop environment on the Windows version of COMSOL Multiphysics.

Application Library path: Rotordynamics_Module/Automotive_and_Aerospace/gearbox_vibration_noise_bearing



Modeling Instructions

From the **File** menu, choose **New**.

NEW



In the **New** window, click  **Model Wizard**.

MODEL WIZARD

- 1 In the **Model Wizard** window, click  **3D**.
- 2 In the **Select Physics** tree, select **Structural Mechanics > Multibody Dynamics (mbd)**.
- 3 Click **Add**.
- 4 Click  **Study**.
- 5 In the **Select Study** tree, select **General Studies > Time Dependent**.
- 6 Click  **Done**.





GEOMETRY 1

Import 1 (imp1)

- 1 In the **Geometry** toolbar, click  **Import**.
- 2 In the **Settings** window for **Import**, locate the **Source** section.
- 3 Click  **Browse**.

- 4 Browse to the model's Application Libraries folder and double-click the file `gearbox_vibration_noise.mphbin`.

Form Union (fin)

- 1 In the **Model Builder** window, under **Component 1 (comp1)** > **Geometry 1** click **Form Union (fin)**.
- 2 In the **Settings** window for **Form Union/Assembly**, locate the **Form Union/Assembly** section.
- 3 From the **Action** list, choose **Form an assembly**.
- 4 Clear the **Create pairs** checkbox.
- 5 In the **Geometry** toolbar, click  **Build All**.
- 6 Click the  **Click and Hide** button in the **Graphics** toolbar.
- 7 In the **Graphics** window toolbar, click  next to  **Select Objects**, then choose **Select Domains**.

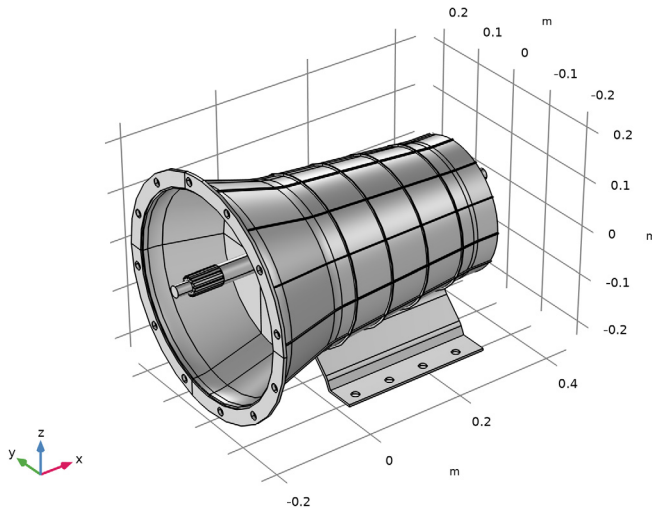

- 8 On the object **fin**, select Domain 4 only.
- 9 Click the  **Click and Hide** button in the **Graphics** toolbar.
Disable the analysis of the geometry as the remaining small geometric details can be kept.
- 10 In the **Model Builder** window, click **Geometry 1**.
- 11 In the **Settings** window for **Geometry**, locate the **Cleanup** section.
- 12 Clear the **Automatic detection of small details** checkbox.

13 In the **Geometry** toolbar, click  **Build All**.

GLOBAL DEFINITIONS

Parameters 1

- 1 In the **Model Builder** window, under **Global Definitions** click **Parameters 1**.
- 2 In the **Settings** window for **Parameters**, locate the **Parameters** section.
- 3 Click  **Load from File**.
- 4 Browse to the model's Application Libraries folder and double-click the file `gearbox_vibration_noise_bearing_parameters.txt`.

Bearing Parameters

- 1 In the **Home** toolbar, click  **Parameters** and choose **Add > Parameters**.
Now add parameters for the roller bearings.
- 2 In the **Settings** window for **Parameters**, type **Bearing Parameters** in the **Label** text field.
- 3 Locate the **Parameters** section. In the table, enter the following settings:

Name	Expression	Value	Description
N	20	20	Number of balls
ds	0.0375[m]	0.0375 m	Shaft diameter
db	$0.8 \cdot \pi \cdot ds / (N - \pi)$	0.0055906 m	Ball diameter
dp	ds+db	0.043091 m	Pitch diameter
r_out	0.53*db	0.002963 m	Outer race radius
r_in	0.53*db	0.002963 m	Inner race radius
phi0	25[deg]	0.43633 rad	Contact angle

DEFINITIONS

Add a step function to apply the loading torque and prescribe the input shaft rotation gradually.

GLOBAL DEFINITIONS

Step 1 (step1)

- 1 In the **Model Builder** window, expand the **Component 1 (comp1) > Definitions** node.
- 2 Right-click **Global Definitions** and choose **Functions > Step**.
- 3 In the **Settings** window for **Step**, locate the **Parameters** section.

- 4 In the **Location** text field, type T/40.
- 5 Click to expand the **Smoothing** section. In the **Size of transition zone** text field, type T/20.

DEFINITIONS



Variables 1

- 1 In the **Model Builder** window, under **Component 1 (comp1)** right-click **Definitions** and choose **Variables**.
- 2 In the **Settings** window for **Variables**, locate the **Variables** section.
- 3 In the table, enter the following settings:



Name	Expression	Unit	Description
an	$mbd.u_ttX*nX+mbd.u_ttY*nY+mbd.u_ttZ*nZ$	m/s ²	Normal acceleration
th	$(\omega*t)*step1(t)$	rad	Main shaft rotation

Foundation 1 (Counter Shaft)



Create some selections for later use.

- 1 In the **Definitions** toolbar, click  **Explicit**.
- 2 In the **Settings** window for **Explicit**, type Foundation 1 (Counter Shaft) in the **Label** text field.
- 3 Locate the **Input Entities** section. From the **Geometric entity level** list, choose **Boundary**.
- 4 Click  **Paste Selection**.
- 5 In the **Paste Selection** dialog, type 367-370 in the **Selection** text field.
- 6 Click **OK**.



Foundation 1 (Main Shaft)

- 1 Right-click **Foundation 1 (Counter Shaft)** and choose **Duplicate**.
- 2 In the **Settings** window for **Explicit**, type Foundation 1 (Main Shaft) in the **Label** text field.
- 3 Locate the **Input Entities** section. Click  **Clear Selection**.
- 4 Click  **Paste Selection**.
- 5 In the **Paste Selection** dialog, type 372-375, 377, 379-381 in the **Selection** text field.
- 6 Click **OK**.



Foundation 2 (Counter Shaft)

- 1 Right-click **Foundation 1 (Main Shaft)** and choose **Duplicate**.
- 2 In the **Settings** window for **Explicit**, type Foundation 2 (Counter Shaft) in the **Label** text field.
- 3 Locate the **Input Entities** section. Click  **Clear Selection**.
- 4 Click  **Paste Selection**.
- 5 In the **Paste Selection** dialog, type 818-821 in the **Selection** text field.
- 6 Click **OK**.

Foundation 2 (Main Shaft)

- 1 Right-click **Foundation 2 (Counter Shaft)** and choose **Duplicate**.
- 2 In the **Settings** window for **Explicit**, type Foundation 2 (Main Shaft) in the **Label** text field.
- 3 Locate the **Input Entities** section. Click  **Clear Selection**.
- 4 Click  **Paste Selection**.
- 5 In the **Paste Selection** dialog, type 824-826, 828, 830, 832-834 in the **Selection** text field.
- 6 Click **OK**.

Bolt Holes

- 1 Right-click **Foundation 2 (Main Shaft)** and choose **Duplicate**.
- 2 In the **Settings** window for **Explicit**, type Bolt Holes in the **Label** text field.
- 3 Locate the **Input Entities** section. Click  **Clear Selection**.
- 4 Click  **Paste Selection**.
- 5 In the **Paste Selection** dialog, type 184-190, 193-209, 214-217, 226-240, 242-246, 533-540, 602-613, 677-680, 683-690 in the **Selection** text field.
- 6 Click **OK**.

Housing

- 1 Right-click **Bolt Holes** and choose **Duplicate**.
- 2 In the **Settings** window for **Explicit**, type Housing in the **Label** text field.
- 3 Locate the **Input Entities** section. From the **Geometric entity level** list, choose **Domain**.
- 4 Click  **Paste Selection**.
- 5 In the **Paste Selection** dialog, type 1-8 in the **Selection** text field.
- 6 Click **OK**.

7 In the **Settings** window for **Explicit**, locate the **Output Entities** section.

8 From the **Output entities** list, choose **Adjacent boundaries**.

Add a **General Extrusion** operator to pick the acceleration of the structural domain in acoustics simulation.

General Extrusion 1 (genext1)

1 In the **Definitions** toolbar, click  **Nonlocal Couplings** and choose **General Extrusion**.

2 In the **Settings** window for **General Extrusion**, locate the **Source Selection** section.

3 From the **Geometric entity level** list, choose **Boundary**.

4 From the **Selection** list, choose **Housing**.

ADD MATERIAL

1 In the **Materials** toolbar, click  **Add Material** to open the **Add Material** window.

2 Go to the **Add Material** window.

3 In the tree, select **Built-in > Structural steel**.

4 Click the **Add to Component** button in the window toolbar.

5 In the **Materials** toolbar, click  **Add Material** to close the **Add Material** window.

MULTIBODY DYNAMICS (MBD)

To start with, define the gears mounted on the counter shaft.

Helical Gear: Fourth (Counter Shaft)

1 In the **Physics** toolbar, click  **Domains** and choose **Helical Gear**.

2 Select Domain 9 only.

3 In the **Settings** window for **Helical Gear**, type Helical Gear: Fourth (Counter Shaft) in the **Label** text field.

4 Locate the **Gear Properties** section. In the n text field, type $n4i$.

5 In the d_p text field, type $d4i$.

6 In the α text field, type α .

7 In the β text field, type β .

8 Locate the **Gear Axis** section. Specify the \mathbf{e}_g vector as

1	x
0	y
0	z

Helical Gears (Counter Shaft)

You can create the remaining helical gears mounted on the counter shaft by duplicating **Helical Gear: Fourth (Counter Shaft)** and resetting the information given in the table below:

Name	Domain	Number of teeth	Pitch diameter
Helical Gear: First (Counter Shaft)	11	n1i	d1i
Helical Gear: Second (Counter Shaft)	13	n2i	d2i
Helical Gear: Third (Counter Shaft)	15	n3i	d3i
Helical Gear: Fifth (Counter Shaft)	17	n5i	d5i

Rigid Material: Counter Shaft

- 1 In the **Physics** toolbar, click  **Domains** and choose **Rigid Material**.
- 2 In the **Settings** window for **Rigid Material**, type Rigid Material: Counter Shaft in the **Label** text field.
- 3 Select Domain 8 only.

Fixed Joint 1

- 1 In the **Physics** toolbar, click  **Global** and choose **Fixed Joint**.
- 2 In the **Settings** window for **Fixed Joint**, locate the **Attachment Selection** section.
- 3 From the **Source** list, choose **Rigid Material: Counter Shaft**.
- 4 From the **Destination** list, choose **Helical Gear: Fourth (Counter Shaft)**.

Fixed Joints

You can create the remaining fixed joints by duplicating **Fixed Joint 1** and resetting the information given in the table below:

Name	Destination
Fixed Joint 2	Helical Gear: First (Counter Shaft)
Fixed Joint 3	Helical Gear: Second (Counter Shaft)
Fixed Joint 4	Helical Gear: Third (Counter Shaft)
Fixed Joint 5	Helical Gear: Fifth (Counter Shaft)

Now define the gears mounted on the main shaft.

Helical Gear: Fourth (Main Shaft)

- 1 In the **Model Builder** window, right-click **Helical Gear: Fourth (Counter Shaft)** and choose **Duplicate**.
- 2 In the **Settings** window for **Helical Gear**, type Helical Gear: Fourth (Main Shaft) in the **Label** text field.
- 3 Locate the **Domain Selection** section. Click  **Clear Selection**.
- 4 Select Domain 10 only.
- 5 Locate the **Gear Properties** section. In the n text field, type n40.
- 6 In the d_p text field, type d40.
- 7 In the β text field, type -beta.

Helical Gears (Main Shaft)

You can create the remaining helical gears mounted on the main shaft by duplicating **Helical Gear: Fourth (Main Shaft)** and resetting the information given in the table below:

Name	Domain	Number of teeth	Pitch diameter
Helical Gear: First (Main Shaft)	12	n10	d10
Helical Gear: Second (Main Shaft)	14	n20	d20
Helical Gear: Third (Main Shaft)	16	n30	d30
Helical Gear: Fifth (Main Shaft)	18	n50	d50

Rigid Material: Main Input Shaft

- 1 In the **Physics** toolbar, click  **Domains** and choose **Rigid Material**.
- 2 In the **Settings** window for **Rigid Material**, type Rigid Material: Main Input Shaft in the **Label** text field.
- 3 Select Domain 1 only.

Rigid Material: Main Output Shaft

- 1 Right-click **Rigid Material: Main Input Shaft** and choose **Duplicate**.
- 2 In the **Settings** window for **Rigid Material**, type Rigid Material: Main Output Shaft in the **Label** text field.
- 3 Locate the **Domain Selection** section. Click  **Clear Selection**.
- 4 Select Domain 2 only.

Add a **Prescribed Displacement/Rotation** node on the **Rigid Material: Main Input Shaft** to specify the input shaft rotation.

Rigid Material: Main Input Shaft

In the **Model Builder** window, click **Rigid Material: Main Input Shaft**.

Prescribed Displacement/Rotation 1

- 1 In the **Physics** toolbar, click  **Attributes** and choose **Prescribed Displacement/Rotation**.
- 2 In the **Settings** window for **Prescribed Displacement/Rotation**, locate the **Prescribed Rotation** section.
- 3 From the **By** list, choose **Prescribed rotation**.
- 4 Specify the Ω vector as

1	x
0	y
0	z

- 5 In the ϕ_0 text field, type π .

Add an **Applied Moment** node on the **Rigid Material: Main Output Shaft** to apply the loading torque.

Rigid Material: Main Output Shaft

In the **Model Builder** window, under **Component 1 (comp1) > Multibody Dynamics (mbd)** click **Rigid Material: Main Output Shaft**.

Applied Moment 1

- 1 In the **Physics** toolbar, click  **Attributes** and choose **Applied Moment**.
- 2 In the **Settings** window for **Applied Moment**, locate the **Applied Moment** section.
- 3 Specify the **M** vector as

$-T_{\text{ext}} \cdot \text{step1}(t)$	x
0	y
0	z

Fixed Joint 6

- 1 In the **Model Builder** window, under **Component 1 (comp1) > Multibody Dynamics (mbd)** right-click **Fixed Joint 5** and choose **Duplicate**.
- 2 In the **Settings** window for **Fixed Joint**, locate the **Attachment Selection** section.
- 3 From the **Source** list, choose **Rigid Material: Main Input Shaft**.

4 From the **Destination** list, choose **Helical Gear: Fourth (Main Shaft)**.

Hinge Joint 1

- 1 In the **Physics** toolbar, click  **Global** and choose **Hinge Joint**.
- 2 In the **Settings** window for **Hinge Joint**, locate the **Attachment Selection** section.
- 3 From the **Source** list, choose **Rigid Material: Main Output Shaft**.
- 4 From the **Destination** list, choose **Helical Gear: First (Main Shaft)**.

Prescribed Motion 1

- 1 In the **Physics** toolbar, click  **Attributes** and choose **Prescribed Motion**.
- 2 In the **Settings** window for **Prescribed Motion**, locate the **Prescribed Rotational Motion** section.
- 3 From the **Activation condition** list, choose **Conditionally active**.
- 4 In the $i_{\theta p}$ text field, type $n!=1$.

Hinge Joints

You can create the remaining hinge joints by duplicating **Hinge Joint 1** and resetting the information given in the table below:

Name	Destination	Deactivating indicator expression
Hinge Joint 2	Helical Gear: Second (Main Shaft)	$n!=2$
Hinge Joint 3	Helical Gear: Third (Main Shaft)	$n!=3$
Hinge Joint 4	Helical Gear: Fifth (Main Shaft)	$n!=5$
Hinge Joint 5	Rigid Material: Main Input Shaft	$n!=4$

Hinge Joint 5

- 1 In the **Model Builder** window, under **Component 1 (comp1) > Multibody Dynamics (mbd)** click **Hinge Joint 5**.
- 2 In the **Settings** window for **Hinge Joint**, locate the **Center of Joint** section.
- 3 From the **Entity level** list, choose **Point**.

Center of Joint: Point 1

- 1 In the **Model Builder** window, click **Center of Joint: Point 1**.
- 2 In the **Settings** window for **Center of Joint: Point**, locate the **Point Selection** section.

- 3 Click  **Paste Selection**.
- 4 In the **Paste Selection** dialog, type 151 - 152 in the **Selection** text field.
- 5 Click **OK**.

After defining all the gears, now define the gear connections.

Gear Pair: Fourth

- 1 In the **Physics** toolbar, click  **Global** and choose **Gear Pair**.
- 2 In the **Settings** window for **Gear Pair**, type Gear Pair: Fourth in the **Label** text field.
- 3 Locate the **Gear Selection** section. From the **Wheel** list, choose **Helical Gear: Fourth (Main Shaft)**.
- 4 From the **Pinion** list, choose **Helical Gear: Fourth (Counter Shaft)**.
- 5 Locate the **Gear Pair Properties** section. Select the **Include gear elasticity** checkbox.

Gear Elasticity I

- 1 In the **Model Builder** window, click **Gear Elasticity I**.
- 2 In the **Settings** window for **Gear Elasticity**, locate the **Mesh Stiffness** section.
- 3 In the $k_{t,wh}$ text field, type kt.
- 4 In the $k_{t,pn}$ text field, type kt.
- 5 From the **Contact ratio in mesh cycle** list, choose **Varying**.
- 6 In the ζ text field, type 0.8.

Gear Pairs

You can create the remaining gear pairs by duplicating **Gear Pair: Fourth** and resetting the information given in the table below:

Name	Wheel	Pinion	Obtained by rotation of tangent in
Gear Pair: First	Helical Gear: First (Counter Shaft)	Helical Gear: First (Main Shaft)	Counterclockwise direction
Gear Pair: Second	Helical Gear: Second (Counter Shaft)	Helical Gear: Second (Main Shaft)	Counterclockwise direction

Name	Wheel	Pinion	Obtained by rotation of tangent in
Gear Pair: Third	Helical Gear: Third (Counter Shaft)	Helical Gear: Third (Main Shaft)	Counterclockwise direction
Gear Pair: Fifth	Helical Gear: Fifth (Counter Shaft)	Helical Gear: Fifth (Main Shaft)	Counterclockwise direction

Now define the connection between the shafts and the housing.

Attachment: Bearing 1 (Counter Shaft)



- 1 In the **Physics** toolbar, click  **Boundaries** and choose **Attachment**.
- 2 In the **Settings** window for **Attachment**, type Attachment: Bearing 1 (Counter Shaft) in the **Label** text field.
- 3 Locate the **Boundary Selection** section. From the **Selection** list, choose **Foundation 1 (Counter Shaft)**.

Attachments

You can create the remaining attachments by duplicating **Attachment: Bearing 1 (Counter Shaft)** and resetting the information given in the table below:

Name	Boundary Selection
Attachment: Bearing 1 (Main Shaft)	Explicit 2
Attachment: Bearing 2 (Counter Shaft)	Explicit 3
Attachment: Bearing 2 (Main Shaft)	Explicit 4

Bearing 1 (Counter Shaft)

- 1 In the **Physics** toolbar, click  **Boundaries** and choose **Radial Roller Bearing**.
- 2 In the **Settings** window for **Radial Roller Bearing**, type Bearing 1 (Counter Shaft) in the **Label** text field.
- 3 Locate the **Boundary Selection** section. Click  **Paste Selection**.
- 4 In the **Paste Selection** dialog, type 878-881 in the **Selection** text field.
- 5 Click **OK**.
- 6 In the **Settings** window for **Radial Roller Bearing**, locate the **Bearing Orientation** section.
- 7 From the **Local y direction** list, choose **User defined**.

- 8 Locate the **Geometric Properties** section. From the **Bearing type** list, choose **Angular contact ball bearing**.
- 9 In the N_b text field, type N.
- 10 In the d_b text field, type db.
- 11 In the d_p text field, type dp.
- 12 In the r_{in} text field, type r_in.
- 13 In the r_{out} text field, type r_out.
- 14 In the ϕ_0 text field, type phi0.
- 15 Locate the **Foundation Properties** section. From the list, choose **Attachment: Bearing 1 (Counter Shaft)**.

Roller bearings

You can create the remaining roller bearings by duplicating **Bearing 1 (Counter Shaft)** and resetting the information given in the table below:

Name	Selection	Contact angle	Foundation
Bearing 1 (Main Shaft)	76-79	-phi0	Attachment: Bearing 1 (Main Shaft)
Bearing 2 (Main Shaft)	100-103	phi0	Attachment: Bearing 2 (Main Shaft)
Bearing 2 (Counter Shaft)	896-899	-phi0	Attachment: Bearing 2 (Counter Shaft)

Fixed Constraint 1

- 1 In the **Physics** toolbar, click  **Boundaries** and choose **Fixed Constraint**.
- 2 In the **Settings** window for **Fixed Constraint**, locate the **Boundary Selection** section.
- 3 From the **Selection** list, choose **Bolt Holes**.

MESH 1

- 1 In the **Model Builder** window, under **Component 1 (comp1)** click **Mesh 1**.
- 2 In the **Settings** window for **Mesh**, locate the **Physics-Controlled Mesh** section.
- 3 From the **Element size** list, choose **Extra coarse**.
- 4 Click  **Build All**.

STUDY: MULTIBODY ANALYSIS

- 1 In the **Settings** window for **Study**, type Study: Multibody Analysis in the **Label** text field.

2 Locate the **Study Settings** section. Clear the **Generate default plots** checkbox.

Step 1: Time Dependent

1 In the **Model Builder** window, under **Study: Multibody Analysis** click **Step 1: Time Dependent**.

2 In the **Settings** window for **Time Dependent**, locate the **Study Settings** section.

3 In the **Output times** text field, type range (0, T/2000, T).

Solution 1 (sol1)

1 In the **Study** toolbar, click  **Show Default Solver**.

Change the scaling of axial rotation to 1 and tilting rotation to 0.01 for all the bearings.

2 In the **Model Builder** window, expand the **Solution 1 (sol1)** node.

3 In the **Model Builder** window, expand the **Study: Multibody Analysis > Solver Configurations > Solution 1 (sol1) > Dependent Variables 1** node, then click **Axial Rotation of Rotor (comp1.mbd.rrb1.th)**.

4 In the **Settings** window for **State**, locate the **Scaling** section.

5 In the **Scale** text field, type 1.

6 In the **Model Builder** window, under **Study: Multibody Analysis > Solver Configurations > Solution 1 (sol1) > Dependent Variables 1** click **Tilt of Rotor About Local y Direction (comp1.mbd.rrb1.alphay)**.

7 In the **Settings** window for **State**, locate the **Scaling** section.

8 In the **Scale** text field, type 1e-2.

9 In the **Model Builder** window, under **Study: Multibody Analysis > Solver Configurations > Solution 1 (sol1) > Dependent Variables 1** click **Tilt of Rotor About Local z Direction (comp1.mbd.rrb1.alphaz)**.

10 In the **Settings** window for **State**, locate the **Scaling** section.

11 In the **Scale** text field, type 1e-2.

12 In the **Model Builder** window, under **Study: Multibody Analysis > Solver Configurations > Solution 1 (sol1) > Dependent Variables 1** click **Axial Rotation of Rotor (comp1.mbd.rrb2.th)**.

13 In the **Settings** window for **State**, locate the **Scaling** section.

14 In the **Scale** text field, type 1.

15 In the **Model Builder** window, under **Study: Multibody Analysis > Solver Configurations > Solution 1 (sol1) > Dependent Variables 1** click **Tilt of Rotor About Local y Direction (comp1.mbd.rrb2.alphay)**.

- 16 In the **Settings** window for **State**, locate the **Scaling** section.
- 17 In the **Scale** text field, type $1e-2$.
- 18 In the **Model Builder** window, under **Study: Multibody Analysis > Solver Configurations > Solution 1 (sol1) > Dependent Variables 1** click
Tilt of Rotor About Local z Direction (comp1.mbd.rrb2.alphaz).
- 19 In the **Settings** window for **State**, locate the **Scaling** section.
- 20 In the **Scale** text field, type $1e-2$.
- 21 In the **Model Builder** window, under **Study: Multibody Analysis > Solver Configurations > Solution 1 (sol1) > Dependent Variables 1** click
Axial Rotation of Rotor (comp1.mbd.rrb3.th).
- 22 In the **Settings** window for **State**, locate the **Scaling** section.
- 23 In the **Scale** text field, type 1.
- 24 In the **Model Builder** window, under **Study: Multibody Analysis > Solver Configurations > Solution 1 (sol1) > Dependent Variables 1** click
Tilt of Rotor About Local y Direction (comp1.mbd.rrb3.alphay).
- 25 In the **Settings** window for **State**, locate the **Scaling** section.
- 26 In the **Scale** text field, type $1e-2$.
- 27 In the **Model Builder** window, under **Study: Multibody Analysis > Solver Configurations > Solution 1 (sol1) > Dependent Variables 1** click
Tilt of Rotor About Local z Direction (comp1.mbd.rrb3.alphaz).
- 28 In the **Settings** window for **State**, locate the **Scaling** section.
- 29 In the **Scale** text field, type $1e-2$.
- 30 In the **Model Builder** window, under **Study: Multibody Analysis > Solver Configurations > Solution 1 (sol1) > Dependent Variables 1** click
Axial Rotation of Rotor (comp1.mbd.rrb4.th).
- 31 In the **Settings** window for **State**, locate the **Scaling** section.
- 32 In the **Scale** text field, type 1.
- 33 In the **Model Builder** window, under **Study: Multibody Analysis > Solver Configurations > Solution 1 (sol1) > Dependent Variables 1** click
Tilt of Rotor About Local y Direction (comp1.mbd.rrb4.alphay).
- 34 In the **Settings** window for **State**, locate the **Scaling** section.
- 35 In the **Scale** text field, type $1e-2$.

- 36 In the **Model Builder** window, under **Study: Multibody Analysis > Solver Configurations > Solution 1 (sol1) > Dependent Variables 1** click **Tilt of Rotor About Local z Direction (comp1.mbd.rrb4.alphaz)**.
- 37 In the **Settings** window for **State**, locate the **Scaling** section.
- 38 In the **Scale** text field, type $1e-2$.
- 39 In the **Model Builder** window, under **Study: Multibody Analysis > Solver Configurations > Solution 1 (sol1)** click **Time-Dependent Solver 1**.
- 40 In the **Settings** window for **Time-Dependent Solver**, click to expand the **Time Stepping** section.
- 41 From the **Steps taken by solver** list, choose **Intermediate**.
- 42 In the **Model Builder** window, expand the **Study: Multibody Analysis > Solver Configurations > Solution 1 (sol1) > Time-Dependent Solver 1** node, then click **Fully Coupled 1**.
- 43 In the **Settings** window for **Fully Coupled**, click to expand the **Method and Termination** section.
- 44 In the **Maximum number of iterations** text field, type 10.
- 45 From the **Jacobian update** list, choose **Once per time step**.
- 46 In the **Study** toolbar, click  **Compute**.



RESULTS

In the **Model Builder** window, expand the **Results** node.

Study: Multibody Analysis/Solution 1 (2) (sol1)

- 1 In the **Model Builder** window, expand the **Results > Datasets** node.
- 2 Right-click **Results > Datasets > Study: Multibody Analysis/Solution 1 (sol1)** and choose **Duplicate**.



Selection

- 1 In the **Results** toolbar, click  **Attributes** and choose **Selection**.
- 2 In the **Settings** window for **Selection**, locate the **Geometric Entity Selection** section.
- 3 From the **Geometric entity level** list, choose **Domain**.
- 4 Click  **Paste Selection**.
- 5 In the **Paste Selection** dialog, type 1-2, 8-18 in the **Selection** text field.
- 6 Click **OK**.

Study: Multibody Analysis/Solution 1 (3) (sol1)

In the **Model Builder** window, under **Results** > **Datasets** right-click **Study: Multibody Analysis/Solution 1 (2) (sol1)** and choose **Duplicate**.

Selection

- 1 In the **Model Builder** window, expand the **Study: Multibody Analysis/Solution 1 (3) (sol1)** node, then click **Selection**.
- 2 In the **Settings** window for **Selection**, locate the **Geometric Entity Selection** section.
- 3 Click  **Clear Selection**.
- 4 Click  **Paste Selection**.
- 5 In the **Paste Selection** dialog, type 3, 5-7 in the **Selection** text field.
- 6 Click **OK**.

Follow the instructions below to plot the stress and normal acceleration in the housing as shown in [Figure 4](#) and [Figure 5](#) respectively.

Velocity - Stress

- 1 In the **Results** toolbar, click  **3D Plot Group**.
- 2 In the **Settings** window for **3D Plot Group**, type **Velocity - Stress** in the **Label** text field.

Surface 1

- 1 Right-click **Velocity - Stress** and choose **Surface**.
- 2 In the **Settings** window for **Surface**, locate the **Data** section.
- 3 From the **Dataset** list, choose **Study: Multibody Analysis/Solution 1 (2) (sol1)**.
- 4 Locate the **Expression** section. In the **Expression** text field, type `mbd.vel`.
- 5 Locate the **Coloring and Style** section. From the **Color table** list, choose **AuroraAustralis**.

Deformation 1



- 1 Right-click **Surface 1** and choose **Deformation**.
- 2 In the **Settings** window for **Deformation**, locate the **Scale** section.
- 3 Select the **Scale factor** checkbox. In the associated text field, type 1.

Surface 2

- 1 In the **Model Builder** window, under **Results** > **Velocity - Stress** right-click **Surface 1** and choose **Duplicate**.
- 2 In the **Settings** window for **Surface**, locate the **Data** section.
- 3 From the **Dataset** list, choose **Study: Multibody Analysis/Solution 1 (3) (sol1)**.

- 4 Locate the **Expression** section. In the **Expression** text field, type `mbd.mises`.
- 5 Locate the **Coloring and Style** section. From the **Color table** list, choose **TrafficLight**.
- 6 Click to expand the **Range** section. Select the **Manual color range** checkbox.
- 7 In the **Minimum** text field, type 0.
- 8 In the **Maximum** text field, type $2e8$.

Velocity - Stress

- 1 In the **Model Builder** window, click **Velocity - Stress**.
- 2 In the **Settings** window for **3D Plot Group**, locate the **Color Legend** section.
- 3 From the **Position** list, choose **Right double**.
- 4 In the **Velocity - Stress** toolbar, click  **Plot**.
- 5 Click the  **Zoom Extents** button in the **Graphics** toolbar.

Velocity - Normal Acceleration

- 1 Right-click **Velocity - Stress** and choose **Duplicate**.
- 2 In the **Model Builder** window, click **Velocity - Stress 1**.
- 3 In the **Settings** window for **3D Plot Group**, type `Velocity - Normal Acceleration` in the **Label** text field.

Surface 2

- 1 In the **Model Builder** window, expand the **Results > Velocity - Normal Acceleration > Surface 2** node, then click **Surface 2**.
- 2 In the **Settings** window for **Surface**, locate the **Expression** section.
- 3 In the **Expression** text field, type `an`.
- 4 Locate the **Range** section. Clear the **Manual color range** checkbox.
- 5 Locate the **Coloring and Style** section. From the **Color table** list, choose **PrismDark**.

Arrow Surface 1

- 1 In the **Model Builder** window, right-click **Velocity - Normal Acceleration** and choose **Arrow Surface**.
- 2 In the **Settings** window for **Arrow Surface**, click **Replace Expression** in the upper-right corner of the **Expression** section. From the menu, choose **Component 1 (comp1) > Multibody Dynamics > Bearing 1 (Counter Shaft) > mbd.rrb1.fbx, ..., mbd.rrb1.fbz - Bearing force distribution (spatial frame)**.
- 3 Locate the **Arrow Positioning** section. From the **Placement** list, choose **Mesh vertices**.
- 4 Locate the **Coloring and Style** section.

5 Select the **Scale factor** checkbox. In the associated text field, type 6E-6.

Deformation 1

- 1 Right-click **Arrow Surface 1** and choose **Deformation**.
- 2 In the **Settings** window for **Deformation**, locate the **Expression** section.
- 3 In the **X-component** text field, type `mbd.rrb1.u_cage`.
- 4 In the **Y-component** text field, type `mbd.rrb1.v_cage`.
- 5 In the **Z-component** text field, type `mbd.rrb1.w_cage`.
- 6 Locate the **Scale** section.
- 7 Select the **Scale factor** checkbox. In the associated text field, type 1.

Arrow Surface 2

- 1 In the **Model Builder** window, under **Results > Velocity - Normal Acceleration** right-click **Arrow Surface 1** and choose **Duplicate**.
- 2 In the **Settings** window for **Arrow Surface**, click to expand the **Inherit Style** section.
- 3 From the **Plot** list, choose **Arrow Surface 1**.
- 4 Clear the **Color** checkbox.
- 5 Locate the **Coloring and Style** section. From the **Color** list, choose **Blue**.
- 6 Click to expand the **Title** section. From the **Title type** list, choose **None**.
- 7 Locate the **Expression** section. In the **X-component** text field, type `mbd.rrb2.fbx`.
- 8 In the **Y-component** text field, type `mbd.rrb2.fby`.
- 9 In the **Z-component** text field, type `mbd.rrb2.fbz`.

Deformation 1

- 1 In the **Model Builder** window, expand the **Arrow Surface 2** node, then click **Deformation 1**.
- 2 In the **Settings** window for **Deformation**, locate the **Expression** section.
- 3 In the **X-component** text field, type `mbd.rrb2.u_cage`.
- 4 In the **Y-component** text field, type `mbd.rrb2.v_cage`.
- 5 In the **Z-component** text field, type `mbd.rrb2.w_cage`.

Arrow Surface 3

- 1 In the **Model Builder** window, under **Results > Velocity - Normal Acceleration** right-click **Arrow Surface 2** and choose **Duplicate**.
- 2 In the **Settings** window for **Arrow Surface**, locate the **Expression** section.
- 3 In the **X-component** text field, type `mbd.rrb3.fbx`.

- 4 In the **Y-component** text field, type `mbd.rrb3.fby`.
- 5 In the **Z-component** text field, type `mbd.rrb3.fbz`.



Deformation 1

- 1 In the **Model Builder** window, expand the **Arrow Surface 3** node, then click **Deformation 1**.
- 2 In the **Settings** window for **Deformation**, locate the **Expression** section.
- 3 In the **X-component** text field, type `mbd.rrb3.u_cage`.
- 4 In the **Y-component** text field, type `mbd.rrb3.v_cage`.
- 5 In the **Z-component** text field, type `mbd.rrb3.w_cage`.

Arrow Surface 4

- 1 In the **Model Builder** window, under **Results > Velocity - Normal Acceleration** right-click **Arrow Surface 3** and choose **Duplicate**.
- 2 In the **Settings** window for **Arrow Surface**, locate the **Coloring and Style** section.
- 3 From the **Color** list, choose **Red**.
- 4 Locate the **Expression** section. In the **X-component** text field, type `mbd.rrb4.fbx`.
- 5 In the **Y-component** text field, type `mbd.rrb4.fby`.
- 6 In the **Z-component** text field, type `mbd.rrb4.fbz`.

Deformation 1



- 1 In the **Model Builder** window, expand the **Arrow Surface 4** node, then click **Deformation 1**.
- 2 In the **Settings** window for **Deformation**, locate the **Expression** section.
- 3 In the **X-component** text field, type `mbd.rrb4.u_cage`.
- 4 In the **Y-component** text field, type `mbd.rrb4.v_cage`.
- 5 In the **Z-component** text field, type `mbd.rrb4.w_cage`.
- 6 In the **Velocity - Normal Acceleration** toolbar, click  **Plot**.
- 7 Click the  **Zoom Extents** button in the **Graphics** toolbar.

Follow the instructions below to plot the time history and frequency spectrum of normal acceleration as shown in [Figure 6](#) and [Figure 7](#) respectively.

Normal Acceleration

- 1 In the **Results** toolbar, click  **ID Plot Group**.
- 2 In the **Settings** window for **ID Plot Group**, type **Normal Acceleration** in the **Label** text field.



Point Graph 1

- 1 Right-click **Normal Acceleration** and choose **Point Graph**.
- 2 In the **Settings** window for **Point Graph**, locate the **Selection** section.
- 3 Click  **Paste Selection**.
- 4 In the **Paste Selection** dialog, type 879 in the **Selection** text field.
- 5 Click **OK**.
- 6 In the **Settings** window for **Point Graph**, locate the **y-Axis Data** section.
- 7 In the **Expression** text field, type an.
- 8 Locate the **x-Axis Data** section. From the **Parameter** list, choose **Expression**.
- 9 In the **Expression** text field, type th.
- 10 From the **Unit** list, choose °.
- 11 In the **Normal Acceleration** toolbar, click  **Plot**.
- 12 Click the  **Zoom Extents** button in the **Graphics** toolbar.

Normal Acceleration: Frequency

- 1 In the **Model Builder** window, right-click **Normal Acceleration** and choose **Duplicate**.
- 2 In the **Settings** window for **ID Plot Group**, type Normal Acceleration: Frequency in the **Label** text field.

Point Graph 1

- 1 In the **Model Builder** window, expand the **Normal Acceleration: Frequency** node, then click **Point Graph 1**.
- 2 In the **Settings** window for **Point Graph**, locate the **x-Axis Data** section.
- 3 From the **Parameter** list, choose **Discrete Fourier transform**.
- 4 From the **Show** list, choose **Frequency spectrum**.
- 5 Select the **Frequency range** checkbox.
- 6 In the **Maximum** text field, type 6000.
- 7 In the **Normal Acceleration: Frequency** toolbar, click  **Plot**.
- 8 Click the  **Zoom Extents** button in the **Graphics** toolbar.

Now add acoustics in the model for computing the noise radiation from the gearbox.



ADD COMPONENT

In the **Model Builder** window, right-click the root node and choose **Add Component > 3D**.

GEOMETRY 2

- 1 In the **Settings** window for **Geometry**, locate the **Advanced** section.
- 2 From the **Geometry representation** list, choose **CAD kernel**.

Import 1 (impl)

- 1 In the **Geometry** toolbar, click  **Import**.
- 2 In the **Settings** window for **Import**, locate the **Source** section.
- 3 Click  **Browse**.
- 4 Browse to the model's Application Libraries folder and double-click the file `gearbox_vibration_noise.mphbin`.



Convert to Solid 1 (csol1)

- 1 In the **Geometry** toolbar, click  **Conversions** and choose **Convert to Solid**.
- 2 Click in the **Graphics** window and then press Ctrl+A to select all objects.





Sphere 1 (sph1)

- 1 In the **Geometry** toolbar, click  **Sphere**.
- 2 In the **Settings** window for **Sphere**, locate the **Size** section.
- 3 In the **Radius** text field, type R.

Difference 1 (dif1)

- 1 In the **Geometry** toolbar, click  **Booleans and Partitions** and choose **Difference**.
- 2 Select the object **sph1** only.
- 3 In the **Settings** window for **Difference**, locate the **Difference** section.
- 4 Click to select the  **Activate Selection** toggle button for **Objects to subtract**.
- 5 Select the object **csol1** only.

Form Union (fin)

- 1 In the **Geometry** toolbar, click  **Build All**.
- 2 Click the  **Zoom Extents** button in the **Graphics** toolbar.
- 3 In the **Model Builder** window, click **Form Union (fin)**.
- 4 Click the  **Click and Hide** button in the **Graphics** toolbar.
- 5 In the **Graphics** window toolbar, click ▼ next to  **Select Objects**, then choose **Select Boundaries**.
- 6 On the object **fin**, select Boundary 2 only.

7 Click the  **Click and Hide** button in the **Graphics** toolbar.

Disable the analysis of the geometry as the remaining small geometric details can be kept.

8 In the **Model Builder** window, click **Geometry 2**.

9 In the **Settings** window for **Geometry**, locate the **Cleanup** section.

10 Clear the **Automatic detection of small details** checkbox.

DEFINITIONS (COMP2)

Explicit 7

1 In the **Model Builder** window, expand the **Component 2 (comp2) > Definitions** node.

2 Right-click **Component 2 (comp2) > Definitions** and choose **Selections > Explicit**.

3 In the **Settings** window for **Explicit**, locate the **Input Entities** section.

4 From the **Geometric entity level** list, choose **Boundary**.

5 Click  **Paste Selection**.

6 In the **Paste Selection** dialog, type 1-4, 349-350, 357, 360 in the **Selection** text field.

7 Click **OK**.

Explicit 8

1 In the **Definitions** toolbar, click  **Explicit**.

2 In the **Settings** window for **Explicit**, locate the **Input Entities** section.

3 From the **Geometric entity level** list, choose **Boundary**.

4 Click  **Paste Selection**.

5 In the **Paste Selection** dialog, type 12-20, 23-40, 43-47, 49, 53-73, 127, 132-134, 139, 144-193, 196-202, 205-207, 210-220, 223-229, 232-234, 237-244, 280-297, 299-318, 320-348, 351-356, 358-359, 361-681, 711-712, 715-720, 723-724, 727-734 in the **Selection** text field.

6 Click **OK**.

ADD MATERIAL

1 In the **Materials** toolbar, click  **Add Material** to open the **Add Material** window.



2 Go to the **Add Material** window.

3 In the tree, select **Built-in > Air**.

4 Click the **Add to Component** button in the window toolbar.

5 In the **Materials** toolbar, click  **Add Material** to close the **Add Material** window.

ADD PHYSICS

- 1 In the **Home** toolbar, click  **Add Physics** to open the **Add Physics** window.
- 2 Go to the **Add Physics** window.
- 3 In the tree, select **Acoustics** > **Pressure Acoustics** > **Pressure Acoustics, Frequency Domain (acpr)**.
- 4 Find the **Physics interfaces in study** subsection. In the table, clear the **Solve** checkbox for **Study: Multibody Analysis**.
- 5 Click the **Add to Component 2** button in the window toolbar.
- 6 In the **Home** toolbar, click  **Add Physics** to close the **Add Physics** window.



PRESSURE ACOUSTICS, FREQUENCY DOMAIN (ACPR)

- 1 In the **Settings** window for **Pressure Acoustics, Frequency Domain**, click to expand the **Discretization** section.
- 2 From the **Element order** list, choose **Linear**.

Spherical Wave Radiation 1

- 1 In the **Physics** toolbar, click  **Boundaries** and choose **Spherical Wave Radiation**.
- 2 In the **Settings** window for **Spherical Wave Radiation**, locate the **Boundary Selection** section.
- 3 From the **Selection** list, choose **Explicit 7**.

Exterior Field Calculation 1

- 1 In the **Physics** toolbar, click  **Boundaries** and choose **Exterior Field Calculation**.
- 2 In the **Settings** window for **Exterior Field Calculation**, locate the **Boundary Selection** section.
- 3 From the **Selection** list, choose **Explicit 7**.
- 4 Click the  **Show More Options** button in the **Model Builder** toolbar.
- 5 In the **Show More Options** dialog, in the tree, select the checkbox for the node **Physics** > **Advanced Physics Options**.
- 6 Click **OK**.
- 7 In the **Settings** window for **Exterior Field Calculation**, click to expand the **Advanced Settings** section.
- 8 Clear the **Use polynomial-preserving recovery for the normal gradient** checkbox.

Normal Acceleration 1

- 1 In the **Physics** toolbar, click  **Boundaries** and choose **Normal Acceleration**.

- 2 In the **Settings** window for **Normal Acceleration**, locate the **Boundary Selection** section.
- 3 From the **Selection** list, choose **Explicit 8**.
- 4 Locate the **Normal Acceleration** section. From the **Type** list, choose **Acceleration**.
- 5 Specify the \mathbf{a}_0 vector as

comp1.genext1(mbd.u_ttX)/T[1/s]	x
comp1.genext1(mbd.u_ttY)/T[1/s]	y
comp1.genext1(mbd.u_ttZ)/T[1/s]	z

MESH 2

Free Tetrahedral 1

In the **Mesh** toolbar, click  **Free Tetrahedral**.

Size

- 1 In the **Model Builder** window, click **Size**.
- 2 In the **Settings** window for **Size**, locate the **Element Size** section.
- 3 Click the **Custom** button.
- 4 Locate the **Element Size Parameters** section. In the **Maximum element size** text field, type 343/3000/4.

Boundary Layers 1

In the **Mesh** toolbar, click  **Boundary Layers**.

Boundary Layer Properties

- 1 In the **Model Builder** window, click **Boundary Layer Properties**.
- 2 In the **Settings** window for **Boundary Layer Properties**, locate the **Geometric Entity Selection** section.
- 3 From the **Selection** list, choose **Explicit 7**.
- 4 Locate the **Layers** section. From the **Thickness specification** list, choose **First layer**.
- 5 In the **Thickness** text field, type 343/3000/4/10.

ADD STUDY

- 1 In the **Home** toolbar, click  **Add Study** to open the **Add Study** window.
- 2 Go to the **Add Study** window.
- 3 Find the **Studies** subsection. In the **Select Study** tree, select **Empty Study**.
- 4 Click the **Add Study** button in the window toolbar.

5 In the **Home** toolbar, click  **Add Study** to close the **Add Study** window.

STUDY: ACOUSTICS (FREQUENCY DOMAIN)

1 In the **Settings** window for **Study**, locate the **Study Settings** section.

2 Clear the **Generate default plots** checkbox.

3 In the **Label** text field, type **Study: Acoustics (Frequency Domain)**.

Step 1: Time to Frequency FFT

1 In the **Study** toolbar, click  **More Study Steps** and choose **Frequency Domain > Time to Frequency FFT**.

2 In the **Settings** window for **Time to Frequency FFT**, locate the **Study Settings** section.

3 From the **Input study** list, choose **Study: Multibody Analysis, Time Dependent**.

4 In the **End time** text field, type **T**.

5 In the **Maximum output frequency** text field, type **250/T**.

6 Locate the **Physics and Variables Selection** section. In the **Solve for** column of the table, under **Component 2 (comp2)**, clear the checkbox for **Pressure Acoustics, Frequency Domain (acpr)**.

Step 2: Frequency Domain

1 In the **Study** toolbar, click  **Frequency Domain**.

2 In the **Settings** window for **Frequency Domain**, locate the **Study Settings** section.

3 In the **Frequencies** text field, type range (1000, 20, 3000).

4 Locate the **Physics and Variables Selection** section. In the **Solve for** column of the table, under **Component 1 (comp1)**, clear the checkbox for **Multibody Dynamics (mbd)**.

5 Click to expand the **Values of Dependent Variables** section. Find the **Values of variables not solved for** subsection. From the **Settings** list, choose **User controlled**.

6 From the **Method** list, choose **Solution**.

7 From the **Study** list, choose **Study: Acoustics (Frequency Domain), Time to Frequency FFT**.

8 From the **Selection** list, choose **Automatic (all solutions)**.

Solution 2 (sol2)

1 In the **Study** toolbar, click  **Show Default Solver**.

2 In the **Model Builder** window, expand the **Solution 2 (sol2)** node.

- 3 In the **Model Builder** window, expand the **Study: Acoustics (Frequency Domain) > Solver Configurations > Solution 2 (sol2) > Dependent Variables 2** node, then click **Acoustic Pressure (comp2.p)**.
- 4 In the **Settings** window for **Field**, locate the **Scaling** section.
- 5 From the **Method** list, choose **Manual**.
- 6 In the **Scale** text field, type $1e5$.
- 7 In the **Model Builder** window, under **Study: Acoustics (Frequency Domain) > Solver Configurations > Solution 2 (sol2)** click **Stationary Solver 1**.
- 8 In the **Settings** window for **Stationary Solver**, locate the **General** section.
- 9 From the **Linearity** list, choose **Linear**.
- 10 In the **Study** toolbar, click  **Compute**.

RESULTS

Study: Acoustics (Frequency Domain)/Solution 2 (6) (sol2)

In the **Model Builder** window, under **Results > Datasets** right-click

Study: Acoustics (Frequency Domain)/Solution 2 (5) (sol2) and choose **Duplicate**.

Selection

- 1 In the **Results** toolbar, click  **Attributes** and choose **Selection**.
- 2 In the **Settings** window for **Selection**, locate the **Geometric Entity Selection** section.
- 3 From the **Geometric entity level** list, choose **Boundary**.
- 4 From the **Selection** list, choose **Explicit 8**.

Follow the instructions below to plot the sound pressure level in the near field, housing surface, and the far field as shown in [Figure 8](#), [Figure 9](#), [Figure 10](#), [Figure 11](#) and [Figure 12](#) respectively.

SPL Near Field

- 1 In the **Results** toolbar, click  **3D Plot Group**.
- 2 In the **Settings** window for **3D Plot Group**, locate the **Data** section.
- 3 From the **Dataset** list, choose **Study: Acoustics (Frequency Domain)/Solution 2 (5) (sol2)**.
- 4 From the **Parameter value (freq (Hz))** list, choose **2000**.
- 5 In the **Label** text field, type **SPL Near Field**.

Slice 1



- 1 Right-click **SPL Near Field** and choose **Slice**.

- 2 In the **Settings** window for **Slice**, locate the **Expression** section.
- 3 In the **Expression** text field, type `acpr.Lp_t`.
- 4 Locate the **Plane Data** section. In the **Planes** text field, type 1.
- 5 Locate the **Coloring and Style** section. From the **Color table** list, choose **Rainbow**.
- 6 From the **Scale** list, choose **Linear**.

Slice 2

- 1 Right-click **Slice 1** and choose **Duplicate**.
- 2 In the **Settings** window for **Slice**, click to expand the **Title** section.
- 3 From the **Title type** list, choose **None**.
- 4 Locate the **Plane Data** section. From the **Plane** list, choose **ZX-planes**.
- 5 In the **Planes** text field, type 1.
- 6 Click to expand the **Inherit Style** section. From the **Plot** list, choose **Slice 1**.

Slice 3



- 1 Right-click **Slice 2** and choose **Duplicate**.
- 2 In the **Settings** window for **Slice**, locate the **Plane Data** section.
- 3 From the **Plane** list, choose **XY-planes**.
- 4 In the **Planes** text field, type 1.
- 5 In the **SPL Near Field** toolbar, click  **Plot**.
- 6 Click the  **Zoom Extents** button in the **Graphics** toolbar.

SPL Casing Surface

- 1 In the **Results** toolbar, click  **3D Plot Group**.
- 2 In the **Settings** window for **3D Plot Group**, locate the **Data** section.
- 3 From the **Dataset** list, choose **Study: Acoustics (Frequency Domain)/Solution 2 (6) (sol2)**.
- 4 From the **Parameter value (freq (Hz))** list, choose **2000**.
- 5 In the **Label** text field, type **SPL Casing Surface**.

Surface 1



- 1 Right-click **SPL Casing Surface** and choose **Surface**.
- 2 In the **Settings** window for **Surface**, locate the **Expression** section.
- 3 In the **Expression** text field, type `acpr.Lp_t`.
- 4 Locate the **Coloring and Style** section. From the **Color table** list, choose **Rainbow**.
- 5 From the **Scale** list, choose **Linear**.

- 6 In the **SPL Casing Surface** toolbar, click  **Plot**.
- 7 Click the  **Zoom Extents** button in the **Graphics** toolbar.

Polar SPL xy-plane

- 1 In the **Results** toolbar, click  **Polar Plot Group**.
- 2 In the **Settings** window for **Polar Plot Group**, type Polar SPL xy-plane in the **Label** text field.
- 3 Locate the **Data** section. From the **Dataset** list, choose **Study: Acoustics (Frequency Domain)/Solution 2 (5) (sol2)**.
- 4 From the **Parameter selection (freq)** list, choose **From list**.
- 5 In the **Parameter values (freq (Hz))** list box, select **2000**.
- 6 Click to expand the **Title** section. From the **Title type** list, choose **Manual**.
- 7 In the **Title** text area, type Sound Pressure Level - Exterior Field (xy-plane) (dB).

Radiation Pattern 1



- 1 In the **Polar SPL xy-plane** toolbar, click  **More Plots** and choose **Radiation Pattern**.
- 2 In the **Settings** window for **Radiation Pattern**, locate the **Evaluation** section.
- 3 Find the **Angles** subsection. In the **Number of angles** text field, type 360.
- 4 Click to expand the **Coloring and Style** section. From the **Width** list, choose **2**.
- 5 In the **Polar SPL xy-plane** toolbar, click  **Plot**.
- 6 Click the  **Zoom Extents** button in the **Graphics** toolbar.

Polar SPL xz-plane

- 1 In the **Model Builder** window, right-click **Polar SPL xy-plane** and choose **Duplicate**.
- 2 In the **Settings** window for **Polar Plot Group**, type Polar SPL xz-plane in the **Label** text field.
- 3 Locate the **Title** section. In the **Title** text area, type Sound Pressure Level - Exterior Field (xz-plane) (dB).

Radiation Pattern 1



- 1 In the **Model Builder** window, expand the **Polar SPL xz-plane** node, then click **Radiation Pattern 1**.
- 2 In the **Settings** window for **Radiation Pattern**, locate the **Evaluation** section.
- 3 Find the **Normal vector** subsection. In the **y** text field, type 1.
- 4 In the **z** text field, type 0.

- 5 In the **Polar SPL xz-plane** toolbar, click  **Plot**.
- 6 Click the  **Zoom Extents** button in the **Graphics** toolbar.

Polar SPL yz-plane



- 1 In the **Model Builder** window, right-click **Polar SPL xz-plane** and choose **Duplicate**.
- 2 In the **Settings** window for **Polar Plot Group**, type Polar SPL yz-plane in the **Label** text field.
- 3 Locate the **Title** section. In the **Title** text area, type Sound Pressure Level - Exterior Field (yz-plane) (dB).

Radiation Pattern 1

- 1 In the **Model Builder** window, expand the **Polar SPL yz-plane** node, then click **Radiation Pattern 1**.
- 2 In the **Settings** window for **Radiation Pattern**, locate the **Evaluation** section.
- 3 Find the **Normal vector** subsection. In the **x** text field, type 1.
- 4 In the **y** text field, type 0.
- 5 In the **Polar SPL yz-plane** toolbar, click  **Plot**.
- 6 Click the  **Zoom Extents** button in the **Graphics** toolbar.

Now first define the microphone locations and then evaluate the pressure on those locations. Also plot the microphone pressure as shown in [Figure 13](#).

Parameters

- 1 In the **Results** toolbar, click  **Parameters**.
- 2 In the **Settings** window for **Parameters**, locate the **Parameters** section.
- 3 Click  **Load from File**.
- 4 Browse to the model's Application Libraries folder and double-click the file gearbox_vibration_noise_results_parameters.txt.

Global Evaluation: Microphone 1

- 1 In the **Results** toolbar, click  **Global Evaluation**.
- 2 In the **Settings** window for **Global Evaluation**, type Global Evaluation: Microphone 1 in the **Label** text field.
- 3 Locate the **Data** section. From the **Dataset** list, choose **Study: Acoustics (Frequency Domain)/Solution 2 (5) (sol2)**.

4 Locate the **Expressions** section. In the table, enter the following settings:

Expression	Unit	Description
<code>abs(if(dm1<=R,at3(xm1,ym1,zm1,p),pext(xm1,ym1,zm1)))</code>	Pa	Pressure (absolute)
<code>arg(if(dm1<=R,at3(xm1,ym1,zm1,p),pext(xm1,ym1,zm1)))</code>	rad	Pressure (phase)
freq	1/s	Frequency

5 Click  **Evaluate**.

TABLE I

Go to the **Table I** window.

Global Evaluation: Microphone 2

- 1 Right-click **Global Evaluation: Microphone 1** and choose **Duplicate**.
- 2 In the **Settings** window for **Global Evaluation**, type Global Evaluation: Microphone 2 in the **Label** text field.
- 3 Locate the **Expressions** section. In the table, enter the following settings:

Expression	Unit	Description
<code>abs(if(dm2<=R,at3(xm2,ym2,zm2,p),pext(xm2,ym2,zm2)))</code>	Pa	Pressure (absolute)
<code>arg(if(dm2<=R,at3(xm2,ym2,zm2,p),pext(xm2,ym2,zm2)))</code>	rad	Pressure (phase)
freq	1/s	Frequency

4 Click  next to  **Evaluate**, then choose **New Table**.



Microphone Pressure

- 1 In the **Results** toolbar, click  **ID Plot Group**.
- 2 In the **Settings** window for **ID Plot Group**, type Microphone Pressure in the **Label** text field.
- 3 Locate the **Data** section. From the **Dataset** list, choose **Study: Acoustics (Frequency Domain)/Solution 2 (5) (sol2)**.
- 4 Click to expand the **Title** section. From the **Title type** list, choose **Manual**.
- 5 In the **Title** text area, type Microphone Pressure (Pa).
- 6 Locate the **Plot Settings** section.
- 7 Select the **y-axis label** checkbox. In the associated text field, type Pressure (Pa).

Global 1



- 1 Right-click **Microphone Pressure** and choose **Global**.
- 2 In the **Settings** window for **Global**, locate the **y-Axis Data** section.
- 3 In the table, enter the following settings:

Expression	Unit	Description
$\text{abs}(\text{if}(\text{dm1} \leq R, \text{at3}(\text{xm1}, \text{ym1}, \text{zm1}, p), \text{pext}(\text{xm1}, \text{ym1}, \text{zm1})))$	Pa	Microphone 1
$\text{abs}(\text{if}(\text{dm2} \leq R, \text{at3}(\text{xm2}, \text{ym2}, \text{zm2}, p), \text{pext}(\text{xm2}, \text{ym2}, \text{zm2})))$	Pa	Microphone 2

- 4 Click to expand the **Coloring and Style** section. From the **Width** list, choose **2**.
- 5 In the **Microphone Pressure** toolbar, click  **Plot**.
- 6 Click the  **Zoom Extents** button in the **Graphics** toolbar.

Follow the instructions below to convert the pressure data from frequency domain to time domain and plot the pressure field in the gearbox surrounding as shown in [Figure 14](#).

ADD STUDY

- 1 In the **Home** toolbar, click  **Add Study** to open the **Add Study** window.
- 2 Go to the **Add Study** window.
- 3 Find the **Studies** subsection. In the **Select Study** tree, select **Empty Study**.
- 4 Click the **Add Study** button in the window toolbar.
- 5 In the **Home** toolbar, click  **Add Study** to close the **Add Study** window.

STUDY: ACOUSTICS (TIME DOMAIN)

- 1 In the **Settings** window for **Study**, type **Study: Acoustics (Time Domain)** in the **Label** text field.
- 2 Locate the **Study Settings** section. Clear the **Generate default plots** checkbox.

Step 1: Frequency to Time FFT

- 1 In the **Study** toolbar, click  **More Study Steps** and choose **Time Dependent > Frequency to Time FFT**.
- 2 In the **Settings** window for **Frequency to Time FFT**, locate the **Study Settings** section.
- 3 In the **Times** text field, type range $(0, T/2000, T/20)$.
- 4 From the **Input study** list, choose **Study: Acoustics (Frequency Domain), Frequency Domain**.

- 5 Locate the **Physics and Variables Selection** section. In the **Solve for** column of the table, under **Component 1 (comp1)**, clear the checkbox for **Multibody Dynamics (mbd)**.
- 6 In the **Study** toolbar, click  **Compute**.

RESULTS

Pressure Near Field: Time

- 1 In the **Results** toolbar, click  **3D Plot Group**.
- 2 In the **Settings** window for **3D Plot Group**, type Pressure Near Field: Time in the **Label** text field.
- 3 Locate the **Data** section. From the **Dataset** list, choose **Study: Acoustics (Time Domain)/ Solution 3 (8) (sol3)**.

Slice 1

- 1 Right-click **Pressure Near Field: Time** and choose **Slice**.
- 2 In the **Settings** window for **Slice**, locate the **Plane Data** section.
- 3 In the **Planes** text field, type 1.
- 4 Locate the **Coloring and Style** section. From the **Color table** list, choose **Wave**.

Slice 2

- 1 Right-click **Slice 1** and choose **Duplicate**.
- 2 In the **Settings** window for **Slice**, locate the **Title** section.
- 3 From the **Title type** list, choose **None**.
- 4 Locate the **Plane Data** section. From the **Plane** list, choose **ZX-planes**.
- 5 In the **Planes** text field, type 1.
- 6 Locate the **Inherit Style** section. From the **Plot** list, choose **Slice 1**.



Slice 3

- 1 Right-click **Slice 2** and choose **Duplicate**.
- 2 In the **Settings** window for **Slice**, locate the **Plane Data** section.
- 3 From the **Plane** list, choose **XY-planes**.
- 4 In the **Planes** text field, type 1.

Filter 1

- 1 In the **Model Builder** window, right-click **Slice 1** and choose **Filter**.
- 2 In the **Settings** window for **Filter**, locate the **Element Selection** section.
- 3 In the **Logical expression for inclusion** text field, type $y > 0$.

Filter 1

- 1 In the **Model Builder** window, right-click **Slice 2** and choose **Filter**.
- 2 In the **Settings** window for **Filter**, locate the **Element Selection** section.
- 3 In the **Logical expression for inclusion** text field, type $x>0$.
- 4 In the **Pressure Near Field: Time** toolbar, click  **Plot**.
- 5 Click the  **Zoom Extents** button in the **Graphics** toolbar.

Create animations to visualize the gearbox vibration and the propagation of the sound wave in the surrounding.

Animation 1

- 1 In the **Results** toolbar, click  **Animation** and choose **Player**.
- 2 In the **Settings** window for **Animation**, locate the **Frames** section.
- 3 In the **Number of frames** text field, type 50.

Animation 2

- 1 Right-click **Animation 1** and choose **Duplicate**.
- 2 In the **Settings** window for **Animation**, locate the **Scene** section.
- 3 From the **Subject** list, choose **Velocity - Normal Acceleration**.

Animation 3

- 1 Right-click **Animation 2** and choose **Duplicate**.
- 2 In the **Settings** window for **Animation**, locate the **Scene** section.
- 3 From the **Subject** list, choose **Pressure Near Field: Time**.

Create **Model Methods** in order to convert the pressure data evaluated at microphone locations into sound files.

NEW METHOD

- 1 In the **Developer** toolbar, click  **New Method**.
- 2 In the **New Method** dialog, type Microphone1 in the **Name** text field.
- 3 Click **OK**.

METHODS

- 1 In the **Application Builder** window, under **Methods** right-click **Microphone1** and choose **Indent and Format**.
- 2 Copy the following code into the **Microphone1** window:

```

// This method is to play the sound at microphone 1.
// It uses absolute value and phase of pressure field as a function of frequency.

if (!model.sol("sol2").isEmpty()) {

    // Evaluate absolute pressure and phase at the given location as a function
    of frequency.
    model.result().numerical("gev1").setResult();
    double[] pressureAbs = model.result().numerical("gev1").getReal()[0];
    double[] pressurePhase = model.result().numerical("gev1").getReal()[1];
    double[] freq = model.result().numerical("gev1").getReal()[2];

    // Convert pressure data into a sound file.
    try {
        // Set the number of samples in the highest frequency wave and the total
        audio time in seconds.
        int n = 20;
        int time = 4;

        float sampleRate = (float) freq[freq.length-1]*n;
        byte buffer[] = new byte[(int) sampleRate*2*time];

        // Use ShortBuffer (signed 16-bit with big-endian byte order) and ByteBuffer
        for easily adding new bytes to the buffer.
        java.nio.ByteBuffer byteBuffer = java.nio.ByteBuffer.wrap(buffer);
        java.nio.ShortBuffer shortBuffer = byteBuffer.asShortBuffer();

        // Set up AudioFormat, DataLine, and SourceDataLine in order to play sound
        with the Java sound API.
        javax.sound.sampled.AudioFormat audioFormat = new
        javax.sound.sampled.AudioFormat(sampleRate, 16, 1, true, true);

        int bytesPerSample = 2;
        for (int i = 0; i < buffer.length/bytesPerSample; i++) {
            double t = i/sampleRate;
            // Add the six components and divide by the sum of the amplitude of the
            signals.
            double amplitude = 0;

            for (int j = 0; j < pressureAbs.length; j++) {
                amplitude += pressureAbs[j]*Math.sin(2*Math.PI*freq[j]*t+
                pressurePhase[j]);
            }

            // Multiply the signal with 1200 in order to get a decent volume on the
            envelope signal.
            shortBuffer.put((short) (1200*amplitude));
        }
        java.io.ByteArrayInputStream byteArrayInputStream = new
        java.io.ByteArrayInputStream(buffer);

        // Write to the file in order to create the file.
        writeFile("temp:///gearbox_vibration_noise_bearing_mic1.wav", "");
        // Get the absolute file path of the generated temp file for the wave output.
        String tempWaveFilePath = getFilePath("temp:///

```

```

gearbox_vibration_noise_bearing_mic1.wav");
    java.io.File waveFile = null;
    if (tempWaveFilePath != null) {
        waveFile = new java.io.File(tempWaveFilePath); // Create a File instance.
    }
    // Create an input stream taking the byte[] buffer.
    javax.sound.sampled.AudioInputStream audioInputStream = new
javax.sound.sampled.AudioInputStream(byteArrayInputStream, audioFormat,
buffer.length/audioFormat.getFrameSize());

    // Write the audio input stream of the sound buffer to the wave file and
play the wave file.
    // A wave file is used instead of directly playing to a source data line for
the sound device on
    // the computer because of the client user interface may run on another
machine.
    // playSound functionality ensures the sound is always played for the client
user interface.
    if (waveFile != null) {
        javax.sound.sampled.AudioSystem.write(audioInputStream,
javax.sound.sampled.AudioFileFormat.Type.WAVE, waveFile);
        playSound("temp:///gearbox_vibration_noise_bearing_mic1.wav");
    }

} catch (Exception ex) {
    debugLog(ex.getMessage());
    error("Error when creating fundamental and harmonics sound combination.");
}
}
}

```

NEW METHOD

- 1 In the **Application Builder** window, right-click **Methods** and choose **New Method**.
- 2 In the **New Method** dialog, type **Microphone2** in the **Name** text field.
- 3 Click **OK**.

METHODS

- 1 In the **Application Builder** window, under **Methods** right-click **Microphone2** and choose **Indent and Format**.
- 2 Copy the following code into the **Microphone2** window:

```

// This method is to play the sound at microphone 2.
// It uses absolute value and phase of pressure field as a function of frequency.

if (!model.sol("sol2").isEmpty()) {

    // Evaluate absolute pressure and phase at the given location as a function
of frequency.
    model.result().numerical("gev2").setResult();
    double[] pressureAbs = model.result().numerical("gev2").getReal()[0];
    double[] pressurePhase = model.result().numerical("gev2").getReal()[1];
}

```

```

double[] freq = model.result().numerical("gev2").getReal()[2];

// Convert pressure data into a sound file.
try {
    // Set the number of samples in the highest frequency wave and the total
    audio time in seconds.
    int n = 20;
    int time = 4;

    float sampleRate = (float) freq[freq.length-1]*n;
    byte buffer[] = new byte[(int) sampleRate*2*time];

    // Use ShortBuffer (signed 16-bit with big-endian byte order) and ByteBuffer
    for easily adding new bytes to the buffer.
    java.nio.ByteBuffer byteBuffer = java.nio.ByteBuffer.wrap(buffer);
    java.nio.ShortBuffer shortBuffer = byteBuffer.asShortBuffer();

    // Set up AudioFormat, DataLine, and SourceDataLine in order to play sound
    with the Java sound API.
    javax.sound.sampled.AudioFormat audioFormat = new
    javax.sound.sampled.AudioFormat(sampleRate, 16, 1, true, true);

    int bytesPerSample = 2;
    for (int i = 0; i < buffer.length/bytesPerSample; i++) {
        double t = i/sampleRate;
        // Add the six components and divide by the sum of the amplitude of the
    signals.
        double amplitude = 0;

        for (int j = 0; j < pressureAbs.length; j++) {
            amplitude += pressureAbs[j]*Math.sin(2*Math.PI*freq[j]*t+
    pressurePhase[j]);
        }

        // Multiply the signal with 1200 in order to get a decent volume on the
    envelope signal.
        shortBuffer.put((short) (1200*amplitude));
    }
    java.io.ByteArrayInputStream byteArrayInputStream = new
    java.io.ByteArrayInputStream(buffer);

    // Write to the file in order to create the file.
    writeFile("temp:///gearbox_vibration_noise_bearing_mic2.wav", "");
    // Get the absolute file path of the generated temp file for the wave output.
    String tempWaveFilePath = getFilePath("temp:///
    gearbox_vibration_noise_bearing_mic2.wav");
    java.io.File waveFile = null;
    if (tempWaveFilePath != null) {
        waveFile = new java.io.File(tempWaveFilePath); // Create a File instance.
    }
    // Create an input stream taking the byte[] buffer.
    javax.sound.sampled.AudioInputStream audioInputStream = new
    javax.sound.sampled.AudioInputStream(byteArrayInputStream, audioFormat,
    buffer.length/audioFormat.getFrameSize());

```



```

    // Write the audio input stream of the sound buffer to the wave file and
    // play the wave file.
    // A wave file is used instead of directly playing to a source data line for
    // the sound device on
    // the computer because of the client user interface may run on another
    // machine.
    // playSound functionality ensures the sound is always played for the client
    // user interface.
    if (waveFile != null) {
        javax.sound.sampled.AudioSystem.write(audioInputStream,
        javax.sound.sampled.AudioFileFormat.Type.WAVE, waveFile);
        playSound("temp:///gearbox_vibration_noise_bearing_mic2.wav");
    }

    } catch (Exception ex) {
        debugLog(ex.getMessage());
        error("Error when creating fundamental and harmonics sound combination.");
    }
}



```

MODEL BUILDER

- 1 In the **Home** toolbar, click  **Model Builder**.
- 2 Click  **Method Call** and choose **Microphone1**.

GLOBAL DEFINITIONS

Microphone1

- 1 In the **Model Builder** window, under **Global Definitions** right-click **Microphone1** and choose **Run**.
- 2 In the **Home** toolbar, click  **Run Method Call** and choose **Microphone1**.
- 3 Click  **Method Call** and choose **Microphone2**.

Microphone2

- 1 In the **Model Builder** window, right-click **Microphone2** and choose **Run**.
- 2 In the **Home** toolbar, click  **Run Method Call** and choose **Microphone2**.

RESULTS

Thumbnail

- 1 In the **Model Builder** window, right-click **Velocity - Stress** and choose **Duplicate**.
- 2 In the **Model Builder** window, click **Velocity - Stress 1**.
- 3 In the **Settings** window for **3D Plot Group**, type **Thumbnail** in the **Label** text field.

Isosurface 1

- 1 Right-click **Thumbnail** and choose **Isosurface**.
- 2 In the **Settings** window for **Isosurface**, locate the **Data** section.
- 3 From the **Dataset** list, choose **Study: Acoustics (Frequency Domain)/Solution 2 (5) (sol2)**.
- 4 From the **Parameter value (freq (Hz))** list, choose **1300**.
- 5 Locate the **Expression** section. In the **Expression** text field, type `acpr.Lp_t`.
- 6 Locate the **Levels** section. In the **Total levels** text field, type 10.

Filter 1

- 1 Right-click **Isosurface 1** and choose **Filter**.
- 2 In the **Settings** window for **Filter**, locate the **Element Selection** section.
- 3 In the **Logical expression for inclusion** text field, type `y>0.1`.
- 4 In the **Thumbnail** toolbar, click  **Plot**.