



Model created in COMSOL Multiphysics 6.4

# Ray Tracing Simulation of a Fresnel Lens

## Introduction

---

A plano-convex lens is often used for focusing or collimating light. To have a short focal length, the lens needs to get very thick, limiting its applicability in scenarios where compactness is important.

Before the early 1800s, the illumination systems of lighthouses were rather poor. The low light intensity and visibility caused a large number of shipwrecks. French physicist and civil engineer Augustin Jean Fresnel was asked to design an improved illumination system for lighthouses. The goal was to construct a compact lens system with short focal length so that light emitted from a small light source, such as a lamp, could be transformed into a relatively narrow and intense beam. This beam would then illuminate a large distance in the sea to guide ships. Fresnel's novel design was successful and, as a result, saved many ships and lives. His design became known as the Fresnel lens (see [Figure 1](#)). Fresnel lenses are widely used in lighthouse illumination systems to this day. Besides, Fresnel lenses also found ubiquitous applications in other areas such as solar energy harvesting systems and so on.



*Figure 1: Comparison of a Fresnel lens (left) with a plano-convex lens (right) with similar focal length. The Fresnel lens is much thinner and lighter.*

The concept of the Fresnel lens is based on the fact that when a nonrefractive part is removed from a lens, the optical performance of the lens mostly stays the same as shown in [Figure 2](#). Therefore, by successively taking out nonrefractive domains in a lens, a much thinner and lighter lens is achieved.

There are various ways to design a Fresnel lens. This model demonstrates how to construct a Fresnel lens from a regular plano-convex lens using a series of geometric operations provided in COMSOL Multiphysics. Later, a ray-tracing simulation is used to confirm the optical performance of the Fresnel lens.

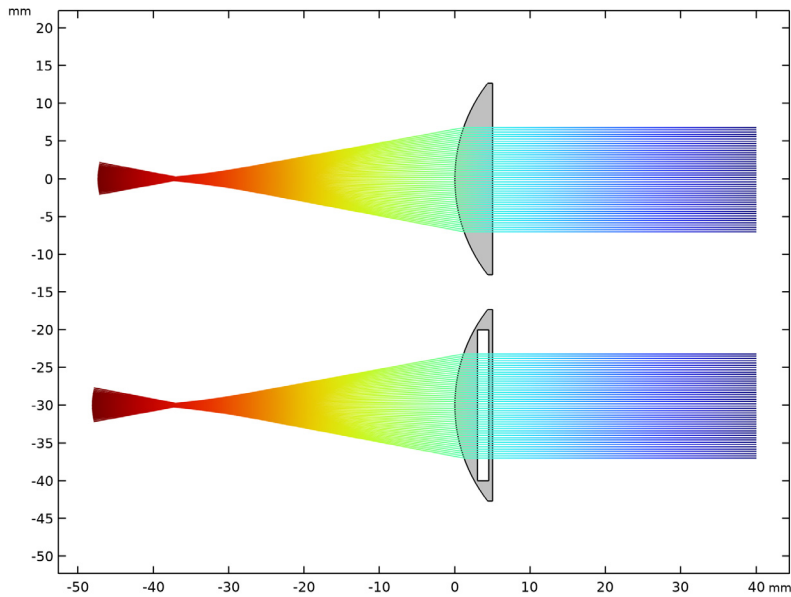

*Figure 2: The optical performance of a lens stays mostly the same when an interior nonrefractive domain is removed from it.*

### *Model Definition*

---

Start from a 3D cylindrical plano-convex lens from the Part Libraries of the Ray Optics Module (Figure 3). The effective focal length is set to 5.5 cm and the diameter to 5 cm. For such a short focal length (compared to the diameter), the lens is very thick, heavy, and expensive to make.

To construct a Fresnel lens from the plano-convex lens, first define the desired Fresnel lens thickness,  $t_{f1}$ . In this case, set  $t_{f1}$  to 2 mm, less than 20% of the original lens thickness. Then, an array of work planes with equal spacing at  $t_{f1}$  are defined and the lens is partitioned with them as shown in Figure 4. Next, use the **Extrude** operators on the partitioned faces to build the nonrefractive cylindrical domains. The cylindrical domains are then removed using the **Delete Entities** operator. Finally, a **Split** operator is used to split the object into individual domains, and the domains are moved to the same plane to form a Fresnel lens as shown in Figure 5.

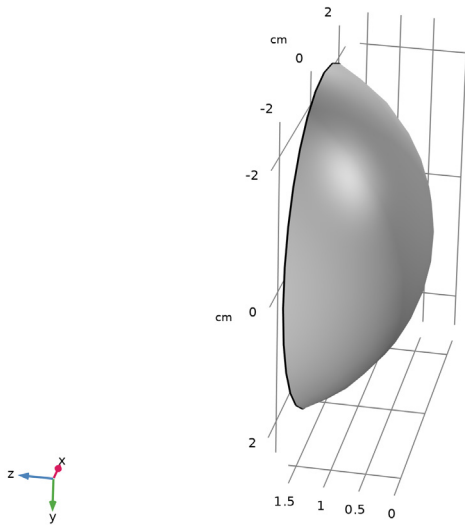

Figure 3: A plano-convex lens imported from the Ray Optics Module Part Library. When the focal length is short, the lens is very thick.

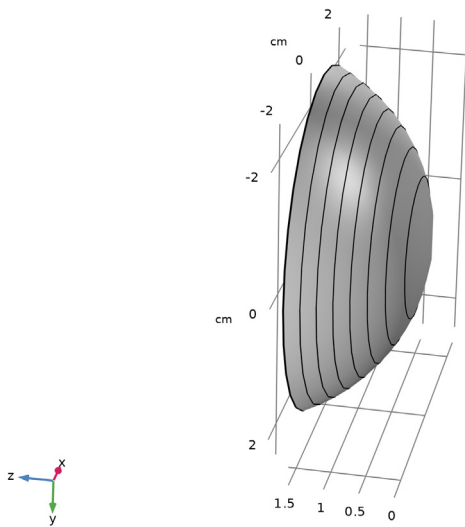
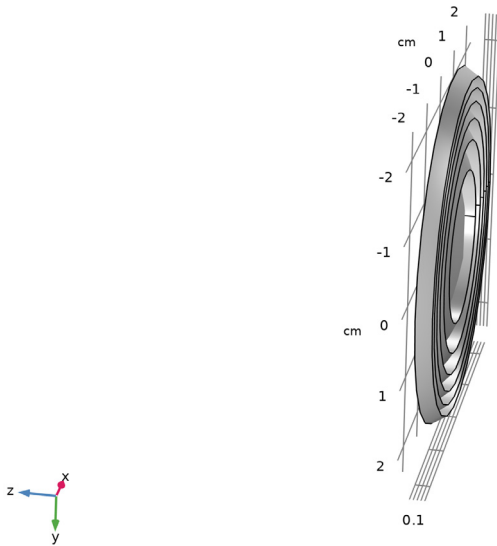

Figure 4: The lens is partitioned by a series of work planes with spacing equal to the desired Fresnel lens thickness.



*Figure 5: Cylindrical domains are removed from the interior of the lens. The remaining outer rings are moved to the same plane to form a flat Fresnel lens.*

## *Results and Discussion*

---

Rays are launched from points located at the focal spots of the Fresnel lens and the regular plano-convex lens. As seen in [Figure 6](#), both lenses collimate the light into beams, but the Fresnel lens is only a fraction of the thickness compared to the plano-convex lens. Due to spherical aberration, the collimation is imperfect in both the Fresnel lens and the plano-convex lens, which can be seen in the spot diagram ([Figure 7](#)).

It is important to emphasize that, fundamentally speaking, a Fresnel lens is a diffractive lens. To rigorously analyze its focusing or collimation capability, a full-wave simulation is needed, as demonstrated in the tutorial model *Fresnel Lens* in the Wave Optics Module Application Library ([www.comsol.com/model/fresnel-lens-46571](http://www.comsol.com/model/fresnel-lens-46571)), which showcases the use of the Wave Optics Module.

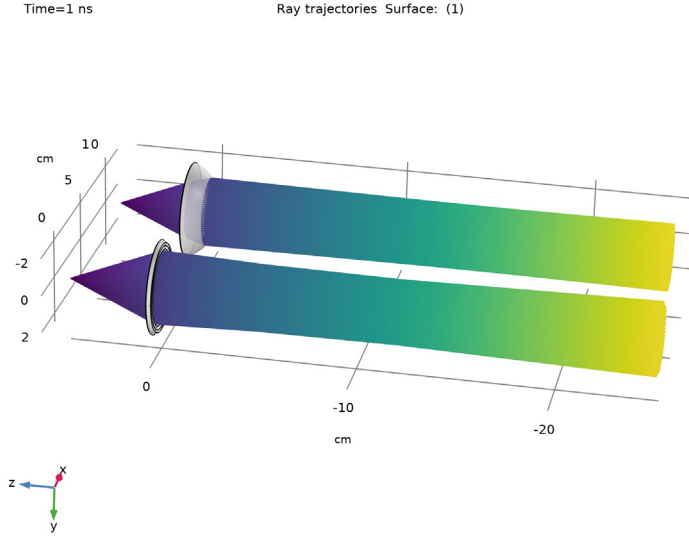

Figure 6: Both the Fresnel lens and the plano-convex lens collimate rays launched at the focal points into beams.

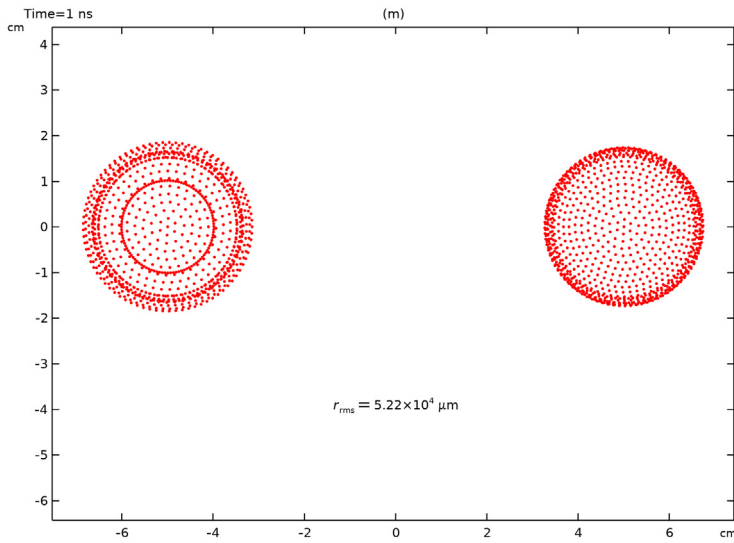

Figure 7: Spot diagram for the Fresnel lens (left) and the plano-convex lens (right) shows spherical aberration as expected.

## *Notes About the COMSOL Implementation*

---

In the process of constructing the Fresnel lens, it is necessary to perform a partition operation on the plano-convex lens. This requires using the CAD kernel. In the current COMSOL kernel, the boolean operations do not find intersections of surfaces that do not intersect any edge.

---

**Application Library path:** Ray\_Optics\_Module/Lenses\_Cameras\_and\_Telescopes/ray\_optics\_modeling\_fresnel\_lens

---

## *Modeling Instructions*



---

From the **File** menu, choose **New**.

### **NEW**

In the **New** window, click  **Model Wizard**.

### **MODEL WIZARD**

- 1 In the **Model Wizard** window, click  **3D**.
- 2 In the **Select Physics** tree, select **Optics > Ray Optics > Geometrical Optics (gop)**.
- 3 Click **Add**.
- 4 Click  **Study**.
- 5 In the **Select Study** tree, select **Preset Studies for Selected Physics Interfaces > Ray Tracing**.
- 6 Click  **Done**.

### **GEOMETRY I**

- 1 In the **Model Builder** window, under **Component 1 (comp1)** click **Geometry 1**.
- 2 In the **Settings** window for **Geometry**, locate the **Units** section.
- 3 From the **Length unit** list, choose **cm**.
- 4 Locate the **Advanced** section. From the **Geometry representation** list, choose **CAD kernel**.

### **GLOBAL DEFINITIONS**



#### *Parameters 1*

- 1 In the **Model Builder** window, under **Global Definitions** click **Parameters 1**.

- 2 In the **Settings** window for **Parameters**, locate the **Parameters** section.
- 3 In the table, enter the following settings:

Name	Expression	Value	Description
f0	5.5[cm]	0.055 m	Effective focal length
n	1.5	1.5	Refractive index
d	5[cm]	0.05 m	Lens diameter
t_fl	0.2[cm]	0.002 m	Designed Fresnel lens thickness
z_image	4.7[cm]	0.047 m	Image position for the Fresnel lens in z direction
dx	10[cm]	0.1 m	Shift of the plano-convex lens position in x direction
dz	-0.7[cm]	-0.007 m	Shift of the plano-convex lens position in z direction

## PART LIBRARIES

- 1 In the **Home** toolbar, click  **Windows** and choose **Part Libraries**.
- 2 In the **Part Libraries** window, select **Ray Optics Module > 3D > Spherical Lenses > spherical\_plano\_convex\_lens\_3d** in the tree.
- 3 Click  **Add to Geometry**.
- 4 In the **Select Part Variant** dialog, select **Specify effective focal length and edge thickness** in the **Select part variant** list.
- 5 Click **OK**.

## GEOMETRY I

### *Spherical Plano-Convex Lens 3D I (pi1)*

- 1 In the **Model Builder** window, under **Component 1 (comp1) > Geometry 1** click **Spherical Plano-Convex Lens 3D I (pi1)**.
- 2 In the **Settings** window for **Part Instance**, locate the **Input Parameters** section.
- 3 In the table, enter the following settings:

Name	Expression	Value	Description
f	f0	5.5 cm	Effective focal length
nref	n	1.5	Refractive index
Te	0.1[mm]	0.01 cm	Edge thickness
d	d	5 cm	Lens diameter

- 4 Click  **Build Selected**. Orient the view to match [Figure 3](#).

The Ray Optics Module part library provides various lenses, mirrors, apertures, and so on. Importing these parts simplifies the modeling workflow.

#### *Work Plane 1 (wp1)*

- 1 In the **Geometry** toolbar, click  **Work Plane**.
- 2 In the **Settings** window for **Work Plane**, locate the **Plane Definition** section.
- 3 In the **z-coordinate** text field, type  $t\_f1$ .

#### *Work Plane 2 (wp2)*

- 1 Right-click **Work Plane 1 (wp1)** and choose **Duplicate**.
- 2 In the **Settings** window for **Work Plane**, locate the **Plane Definition** section.
- 3 In the **z-coordinate** text field, type  $2*t\_f1$ .

#### *Work Plane 3 (wp3)*

- 1 Right-click **Work Plane 2 (wp2)** and choose **Duplicate**.
- 2 In the **Settings** window for **Work Plane**, locate the **Plane Definition** section.
- 3 In the **z-coordinate** text field, type  $3*t\_f1$ .

#### *Work Plane 4 (wp4)*

- 1 Right-click **Work Plane 3 (wp3)** and choose **Duplicate**.
- 2 In the **Settings** window for **Work Plane**, locate the **Plane Definition** section.
- 3 In the **z-coordinate** text field, type  $4*t\_f1$ .

#### *Work Plane 5 (wp5)*

- 1 Right-click **Work Plane 4 (wp4)** and choose **Duplicate**.
- 2 In the **Settings** window for **Work Plane**, locate the **Plane Definition** section.
- 3 In the **z-coordinate** text field, type  $5*t\_f1$ .

#### *Work Plane 6 (wp6)*

- 1 Right-click **Work Plane 5 (wp5)** and choose **Duplicate**.
- 2 In the **Settings** window for **Work Plane**, locate the **Plane Definition** section.
- 3 In the **z-coordinate** text field, type  $6*t\_f1$ .

#### *Work Plane 7 (wp7)*

- 1 Right-click **Work Plane 6 (wp6)** and choose **Duplicate**.
- 2 In the **Settings** window for **Work Plane**, locate the **Plane Definition** section.

3 In the **z-coordinate** text field, type  $7*t\_f1$ .

A series of Work Planes are created. The spacing between the planes are set to the desirable Fresnel lens thickness.

#### *Partition Objects 1 (par1)*

- 1 In the **Geometry** toolbar, click  **Booleans and Partitions** and choose **Partition Objects**.
- 2 Select the object **pi1** only.
- 3 In the **Settings** window for **Partition Objects**, locate the **Partition Objects** section.
- 4 From the **Partition with** list, choose **Work plane**.
- 5 From the **Work plane** list, choose **Work Plane 1 (wp1)**.

#### *Partition Objects 2 (par2)*

- 1 In the **Geometry** toolbar, click  **Booleans and Partitions** and choose **Partition Objects**.
- 2 Select the object **par1** only.
- 3 In the **Settings** window for **Partition Objects**, locate the **Partition Objects** section.
- 4 From the **Partition with** list, choose **Work plane**.
- 5 From the **Work plane** list, choose **Work Plane 2 (wp2)**.

#### *Partition Objects 3 (par3)*

- 1 In the **Geometry** toolbar, click  **Booleans and Partitions** and choose **Partition Objects**.
- 2 Select the object **par2** only.
- 3 In the **Settings** window for **Partition Objects**, locate the **Partition Objects** section.
- 4 From the **Partition with** list, choose **Work plane**.
- 5 From the **Work plane** list, choose **Work Plane 3 (wp3)**.

#### *Partition Objects 4 (par4)*

- 1 In the **Geometry** toolbar, click  **Booleans and Partitions** and choose **Partition Objects**.
- 2 Select the object **par3** only.
- 3 In the **Settings** window for **Partition Objects**, locate the **Partition Objects** section.
- 4 From the **Partition with** list, choose **Work plane**.
- 5 From the **Work plane** list, choose **Work Plane 4 (wp4)**.

#### *Partition Objects 5 (par5)*



- 1 In the **Geometry** toolbar, click  **Booleans and Partitions** and choose **Partition Objects**.
- 2 Select the object **par4** only.
- 3 In the **Settings** window for **Partition Objects**, locate the **Partition Objects** section.

- 4 From the **Partition with** list, choose **Work plane**.
- 5 From the **Work plane** list, choose **Work Plane 5 (wp5)**.



*Partition Objects 6 (par6)*

- 1 In the **Geometry** toolbar, click  **Booleans and Partitions** and choose **Partition Objects**.
- 2 Select the object **par5** only.
- 3 In the **Settings** window for **Partition Objects**, locate the **Partition Objects** section.
- 4 From the **Partition with** list, choose **Work plane**.
- 5 From the **Work plane** list, choose **Work Plane 6 (wp6)**.

*Partition Objects 7 (par7)*

- 1 In the **Geometry** toolbar, click  **Booleans and Partitions** and choose **Partition Objects**.
- 2 Select the object **par6** only.
- 3 In the **Settings** window for **Partition Objects**, locate the **Partition Objects** section.
- 4 From the **Partition with** list, choose **Work plane**.
- 5 Click  **Build Selected**. The lens is partitioned with work planes and should look like [Figure 4](#).

*Extrude 1 (ext1)*

- 1 In the **Geometry** toolbar, click  **Extrude**.
- 2 Click the  **Wireframe Rendering** button in the **Graphics** toolbar.
- 3 In the **Settings** window for **Extrude**, locate the **General** section.
- 4 From the **Extrude from** list, choose **Faces**.
- 5 On the object **par7**, select Boundary 5 only.
- 6 Locate the **Distances** section. In the table, enter the following settings:

<b>Distances (cm)</b>
t_f1

*Extrude 2 (ext2)*

- 1 In the **Geometry** toolbar, click  **Extrude**.
- 2 In the **Settings** window for **Extrude**, locate the **General** section.
- 3 From the **Extrude from** list, choose **Faces**.
- 4 On the object **ext1**, select Boundary 10 only.

5 Locate the **Distances** section. In the table, enter the following settings:

---

<b>Distances (cm)</b>
t_f1

---

*Extrude 3 (ext3)*

- 1 In the **Geometry** toolbar, click  **Extrude**.
- 2 In the **Settings** window for **Extrude**, locate the **General** section.
- 3 From the **Extrude from** list, choose **Faces**.
- 4 On the object **ext2**, select Boundary 15 only.
- 5 Locate the **Distances** section. In the table, enter the following settings:

---

<b>Distances (cm)</b>
t_f1

---

*Extrude 4 (ext4)*

- 1 In the **Geometry** toolbar, click  **Extrude**.
- 2 In the **Settings** window for **Extrude**, locate the **General** section.
- 3 From the **Extrude from** list, choose **Faces**.
- 4 On the object **ext3**, select Boundary 20 only.
- 5 Locate the **Distances** section. In the table, enter the following settings:

---

<b>Distances (cm)</b>
t_f1

---

*Extrude 5 (ext5)*

- 1 In the **Geometry** toolbar, click  **Extrude**.
- 2 In the **Settings** window for **Extrude**, locate the **General** section.
- 3 From the **Extrude from** list, choose **Faces**.
- 4 On the object **ext4**, select Boundary 25 only.
- 5 Locate the **Distances** section. In the table, enter the following settings:

---

<b>Distances (cm)</b>
t_f1

---

*Extrude 6 (ext6)*

- 1 In the **Geometry** toolbar, click  **Extrude**.

- 2 In the **Settings** window for **Extrude**, locate the **General** section.
- 3 From the **Extrude from** list, choose **Faces**.
- 4 On the object **ext5**, select Boundary 30 only.
- 5 Locate the **Distances** section. In the table, enter the following settings:

Distances (cm)
t_f1

#### *Extrude 7 (ext7)*

- 1 In the **Geometry** toolbar, click  **Extrude**.
- 2 In the **Settings** window for **Extrude**, locate the **General** section.
- 3 From the **Extrude from** list, choose **Faces**.
- 4 On the object **ext6**, select Boundary 36 only.
- 5 Locate the **Distances** section. In the table, enter the following settings:

Distances (cm)
t_f1

#### *Delete Entities 1 (dell)*

- 1 In the **Model Builder** window, right-click **Geometry 1** and choose **Delete Entities**.
- 2 In the **Settings** window for **Delete Entities**, locate the **Entities or Objects to Delete** section.
- 3 From the **Geometric entity level** list, choose **Domain**.
- 4 On the object **ext7**, select Domains 1, 2, 4, 6, 8, 10, 12, and 14 only.

The cylinder domains are removed from the lens. Since the spherical lens has significant aberration away from the lens center, the outermost ring domain is also removed.

#### *Split 1 (spl1)*

- 1 In the **Geometry** toolbar, click  **Conversions** and choose **Split**.
- 2 Select the object **dell** only.

The lens object is split into individual ring-shaped domains so that each ring-shaped domain can be moved into the same plane to form a flat Fresnel lens.

#### *Move 1 (mov1)*

- 1 In the **Geometry** toolbar, click  **Transforms** and choose **Move**.
- 2 Select the object **spl1(6)** only.
- 3 In the **Settings** window for **Move**, locate the **Displacement** section.

4 In the **z** text field, type  $-t_{f1}$ .

*Move 2 (mov2)*

1 In the **Geometry** toolbar, click  **Transforms** and choose **Move**.

2 Select the object **spl1(4)** only.

3 In the **Settings** window for **Move**, locate the **Displacement** section.

4 In the **z** text field, type  $-2*t_{f1}$ .

*Move 3 (mov3)*

1 In the **Geometry** toolbar, click  **Transforms** and choose **Move**.

2 Select the object **spl1(3)** only.

3 In the **Settings** window for **Move**, locate the **Displacement** section.

4 In the **z** text field, type  $-3*t_{f1}$ .

*Move 4 (mov4)*

1 In the **Geometry** toolbar, click  **Transforms** and choose **Move**.

2 Select the object **spl1(2)** only.

3 In the **Settings** window for **Move**, locate the **Displacement** section.

4 In the **z** text field, type  $-4*t_{f1}$ .

*Move 5 (mov5)*

1 In the **Geometry** toolbar, click  **Transforms** and choose **Move**.

2 Select the object **spl1(1)** only.

3 In the **Settings** window for **Move**, locate the **Displacement** section.

4 In the **z** text field, type  $-5*t_{f1}$ .

*Move 6 (mov6)*

1 In the **Geometry** toolbar, click  **Transforms** and choose **Move**.

2 Select the object **spl1(7)** only.

3 In the **Settings** window for **Move**, locate the **Displacement** section.

4 In the **z** text field, type  $-6*t_{f1}$ .

5 Click  **Build Selected**.

6 Click the  **Wireframe Rendering** button in the **Graphics** toolbar. Compare the resulting image to [Figure 5](#).

Each ring-shaped domain is moved into the same plane to form a flat Fresnel lens.

### Point 1 (pt1)



- 1 In the **Geometry** toolbar, click  **More Primitives** and choose **Point**.
- 2 In the **Settings** window for **Point**, locate the **Point** section.
- 3 In the **z** text field, type `z_image`.

### Point 2 (pt2)

- 1 Right-click **Point 1 (pt1)** and choose **Duplicate**.
- 2 In the **Settings** window for **Point**, locate the **Point** section.
- 3 In the **x** text field, type `dx`.
- 4 Click  **Build Selected**.

Two points are created at the focal spots to launch rays.

### Spherical Plano-Convex Lens 3D 2 (pi2)

- 1 In the **Model Builder** window, under **Component 1 (comp1)** > **Geometry 1** right-click **Spherical Plano-Convex Lens 3D 1 (pi1)** and choose **Duplicate**.
- 2 In the **Settings** window for **Part Instance**, locate the **Position and Orientation of Output** section.
- 3 Find the **Displacement** subsection. In the **xwi** text field, type `dx`.
- 4 In the **zwi** text field, type `dz`.
- 5 Click  **Build All Objects**.
- 6 Click the  **Zoom Extents** button in the **Graphics** toolbar.

Another plano-convex lens is created for the direct comparison with the Fresnel lens.

## MATERIALS

### Material 1 (mat1)

- 1 In the **Model Builder** window, under **Component 1 (comp1)** right-click **Materials** and choose **Blank Material**.
- 2 In the **Settings** window for **Material**, locate the **Material Contents** section.
- 3 In the table, enter the following settings:

Property	Variable	Value	Unit	Property group
Refractive index, real part	<code>n_iso ; nii = n_iso, nij = 0</code>	<code>n</code>	<code>1</code>	Refractive index

## GEOMETRICAL OPTICS (GOP)

### *Material Discontinuity I*

- 1 In the **Model Builder** window, under **Component 1 (comp1) > Geometrical Optics (gop)** click **Material Discontinuity I**.
- 2 In the **Settings** window for **Material Discontinuity**, locate the **Rays to Release** section.
- 3 From the **Release reflected rays** list, choose **Never**.

### *Release from Point I*

- 1 In the **Physics** toolbar, click  **Points** and choose **Release from Point**.
- 2 Select Points 14 and 32 only.
- 3 In the **Settings** window for **Release from Point**, locate the **Ray Direction Vector** section.
- 4 From the **Ray direction vector** list, choose **Conical**.
- 5 In the  $N_w$  text field, type 1000.
- 6 Specify the **r** vector as

0	x
0	y
-1	z

- 7 In the  $\alpha$  text field, type  $\pi/8$ .

## MESH I

- 1 In the **Model Builder** window, under **Component 1 (comp1)** click **Mesh I**.
- 2 In the **Settings** window for **Mesh**, locate the **Physics-Controlled Mesh** section.
- 3 From the **Element size** list, choose **Extra coarse**.
- 4 Click  **Build All**.

## STUDY I

In the **Study** toolbar, click  **Compute**.

## RESULTS

### *Ray Trajectories (gop)*

In the **Model Builder** window, expand the **Ray Trajectories (gop)** node.

### *Color Expression 1*

- 1 In the **Model Builder** window, expand the **Results > Ray Trajectories (gop) > Ray Trajectories 1** node, then click **Color Expression 1**.
- 2 In the **Settings** window for **Color Expression**, locate the **Coloring and Style** section.
- 3 Clear the **Color legend** checkbox.
- 4 From the **Color table** list, choose **Viridis**.

### *Ray Trajectories (gop)*

In the **Ray Trajectories (gop)** toolbar, click  **Surface**.

### *Material Appearance 1*

In the **Ray Trajectories (gop)** toolbar, click  **Material Appearance**.

### *Transparency 1*

- 1 In the **Model Builder** window, right-click **Surface 1** and choose **Transparency**.
- 2 In the **Settings** window for **Transparency**, locate the **Transparency** section.
- 3 Find the **Transparency** subsection. Set the **Transparency** value to **0.2**.
- 4 Click the  **Zoom Extents** button in the **Graphics** toolbar. The plot should look like [Figure 6](#).

### *Spot Diagram*

- 1 In the **Results** toolbar, click  **2D Plot Group**.
- 2 In the **Settings** window for **2D Plot Group**, type **Spot Diagram** in the **Label** text field.

### *Spot Diagram 1*

- 1 In the **Spot Diagram** toolbar, click  **More Plots** and choose **Spot Diagram**.
- 2 Click  **Plot**. The plot should look like [Figure 7](#).

The spot diagram shows spherical aberration near the outer edge of the beam in both the Fresnel lens (left) and the plano-convex lens (right). This is expected in spherical lenses.