



Model created in COMSOL Multiphysics 6.4

Petzval Lens

Introduction

A Petzval lens comprises two positive lens groups that are separated by air. By using a pair of doublets, astigmatism can be controlled over restricted fields of view with modest numerical apertures.

The basic Petzval lens configuration will invariably result in a best focus image surface that is concave. This can be corrected by placing a negative lens element as close as possible to the image plane. In this tutorial, a field-flattened Petzval will be demonstrated.

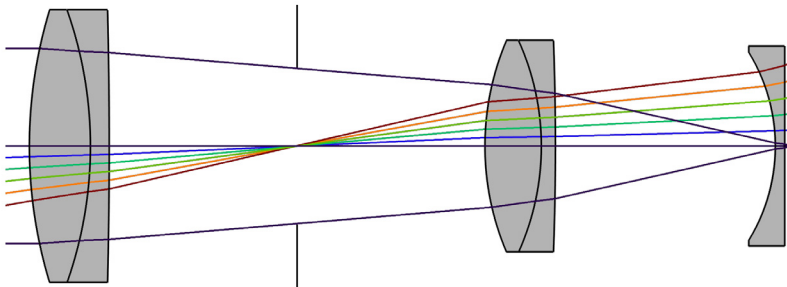

Figure 1: Overview of the Petzval lens. The lens includes a field-flattening element. In this view the marginal rays of an on-axis trace are shown, together with the chief ray of 5 additional fields.

Model Definition

The field-flattened Petzval lens simulated in this study is based on the prescription from [Ref. 1](#), p. 191. The focal length is 100.0 mm and the focal ratio is approximately $f/2.4$. An overview of the lens layout can be seen in [Figure 1](#), and the parameters of this lens are shown in [Table 1](#). Note that some of the lens materials have replaced with equivalents from the built-in Optical material library and the back focal length has been adjusted.

The instructions for creating the lens geometry can be found in the [Appendix — Geometry Instructions](#). In addition to the lens parameters used to define the lens geometry, a set of parameters are required to define the ray trace. These are detailed in [Table 2](#).

TABLE 1: PETZVAL LENS PARAMETERS.

Index	Name	Radius (mm)	Thickness (mm)	Material	Clear radius (mm)
—	Object	∞	∞	—	—
1	Lens 1	98.45049	13.00000	N-BK7	28.478
2	Lens 2	-83.29386	4.00000	N-KZFS5	26.267
—	—	-1421.38828	40.00000	—	22.020
3	Stop	∞	40.00000	—	16.631
4	Lens 3	59.00613	12.00000	N-SK2	20.543
5	Lens 4	-54.36470	3.00000	N-SF5	20.074
—	—	-549.36547	46.82210	—	16.492
6	Lens 5	-39.80076	2.00000	N-SF5	17.297
—	—	∞	1.9548	—	18.940
—	Image	∞	—	—	17.904

TABLE 2: GLOBAL PARAMETER DEFINITIONS.

Parameter	Value	Description
λ_{vac}	475nm, 550nm, 625nm	Nominal (vacuum) wavelengths
θ_x	0°	Nominal x field angle
θ_y	0°, 6°, 9°	Nominal y field angles
N_{ring}	12	Number of hexapolar rings. ($N_{\text{ring}} = 12$ will give a total of 469 rays.)
P_{nom}	41.5 mm	Nominal entrance pupil diameter
P_{fac1}	-1.142	Pupil shift factor 1
P_{fac2}	-0.080	Pupil shift factor 2

Several of the parameters defined in [Table 2](#) are used to derive additional parameters such as the ray direction vector components, the stop and image plane z -coordinates, and the entrance pupil location. [Table 3](#) gives the expressions used to derive these parameters. Note that the pupil shift factor is an empirical approximation to ensure that the chief ray passes through the center of the stop at all field angles.

TABLE 3: GLOBAL PARAMETER DEFINITIONS (DERIVED).

Parameter	Value	Description
v_x	$\tan\theta_x$	Ray direction vector, x -component
v_y	$\tan\theta_y$	Ray direction vector, y -component
v_z	1	Ray direction vector, z -component
z_{stop}	$2 \sum_{n=1} (T_{c,n} + T_n)$	Stop z -coordinate, where $T_{c,n}$ is the central thickness of element n and T_n is the separation between elements n and $n+1$. Note that the stop is the third element in the Petzval lens.
z_{image}	$6 \sum_{n=1} (T_{c,n} + T_n)$	Image plane z -coordinate, where $T_{c,n}$ is the central thickness of element n and T_n is the separation between elements n and $n+1$. Including the stop, the Petzval lens has 6 elements.
P_{fac}	$P_{\text{fac}1} + P_{\text{fac}2} \sin\theta$	Pupil shift factor, where $\theta = \sqrt{\theta_x^2 + \theta_y^2}$
Δx_{pupil}	$(\Delta z_{\text{pupil}} + P_{\text{fac}} z_{\text{stop}})\tan\theta_x$	Pupil shift, x -coordinate
Δy_{pupil}	$(\Delta z_{\text{pupil}} + P_{\text{fac}} z_{\text{stop}})\tan\theta_y$	Pupil shift, y -coordinate

Results and Discussion

In this simulation the lens geometry is constructed by repeated insertions of part instances from the COMSOL Part Libraries. Each lens element is inserted sequentially, such that each subsequent lens is placed relative to the prior one. This process is simplified by making use of the predefined work planes within the “Spherical Lens 3D” part instance.

It is important to appreciate that the ray tracing method used by the Geometrical Optics interface is inherently nonsequential, so the same result could be obtained by placing part instances within the geometry in any order. In order to limit the rays to those that reach the focal plane, additional aperture stops and obstructions are added to the geometry. These items can also be placed by using the predefined work planes from each of the lens part instances. The Petzval lens geometry sequence is shown in [Figure 2](#) and the mesh can be seen in [Figure 3](#).

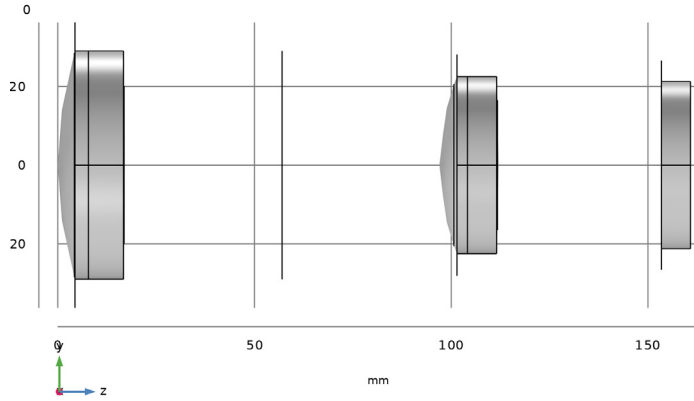

Figure 2: The Petzval lens geometry sequence.

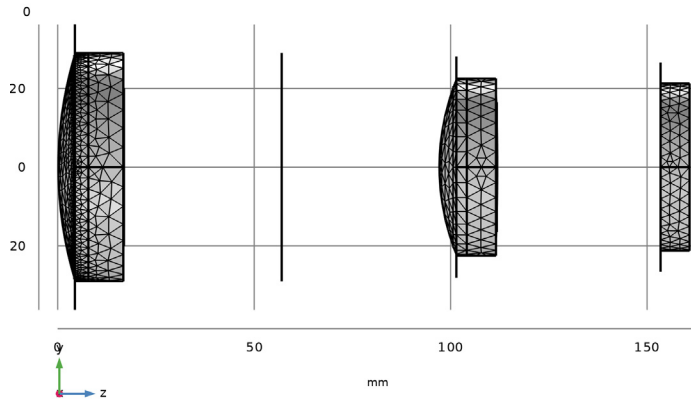

Figure 3: The Petzval lens mesh.

A ray trace has been performed at three wavelengths (475 nm, 550 nm, and 625 nm) and three field angles (on-axis, 6°, and 9°). In Figure 4 the ray trajectories can be seen colored by optical path length. The slice plot in the background of this figure indicates the d-line refractive index n_d of each material, which highlights the disparity in refractive index between the crown and flint glasses of each cemented doublet. In Figure 5, a color expression based on the location of the rays at the image plane is used. This allows the relative contribution of rays at the pupil to the final image quality to be easily visualized.

Finally, in Figure 6 a spot diagram is shown. In this plot the points are colored according to their initial location in the pupil. This complements the coloring of the ray diagram in Figure 5.

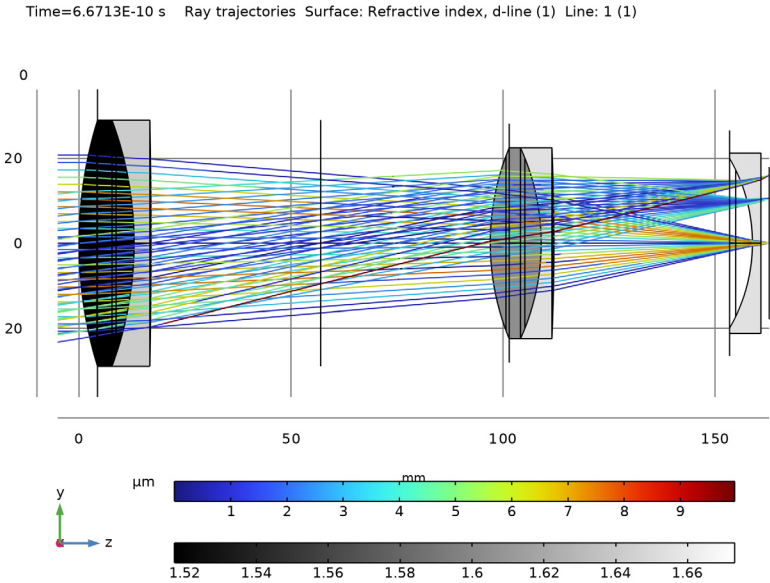

Figure 4: Ray diagram of the Petzval lens colored by radial distance from the centroid.

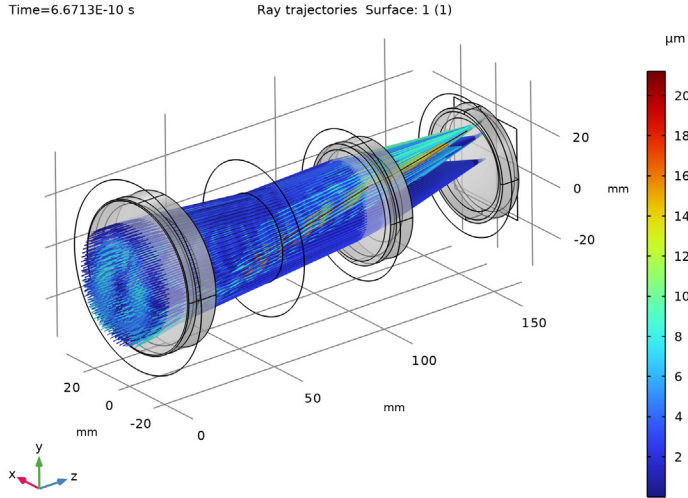

Figure 5: Ray diagram of the Petzval lens where the rays are colored by their radial distance from the centroid on the image plane.

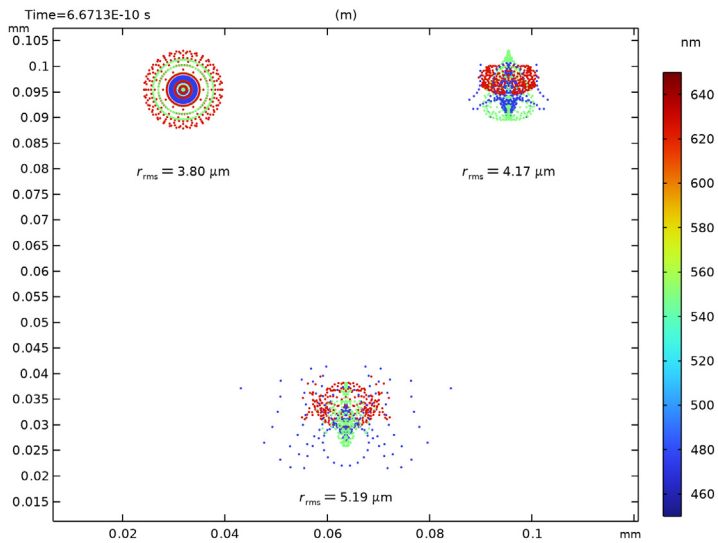

Figure 6: Spot diagram for the Petzval lens. The color indicates the wavelength.

Reference

1. M.J. Kidger, *Fundamental Optical Design*, SPIE Press, 2001.

Application Library path: Ray_Optics_Module/Lenses_Cameras_and_Telescopes/petzval_lens



Modeling Instructions

From the **File** menu, choose **New**.

NEW

In the **New** window, click  **Model Wizard**.

MODEL WIZARD

- 1 In the **Model Wizard** window, click  **3D**.
- 2 In the **Select Physics** tree, select **Optics > Ray Optics > Geometrical Optics (gop)**.
- 3 Click **Add**.
- 4 Click  **Study**.
- 5 In the **Select Study** tree, select **Preset Studies for Selected Physics Interfaces > Ray Tracing**.
- 6 Click  **Done**.



GLOBAL DEFINITIONS

Parameters 1: Lens Prescription

- 1 In the **Model Builder** window, under **Global Definitions** click **Parameters 1**.
- 2 In the **Settings** window for **Parameters**, type Parameters 1: Lens Prescription in the **Label** text field. The lens prescription will be added when the geometry sequence is inserted in the following section.

Parameters 2: General





The Petzval Lens simulation parameters can be loaded from a text file.

- 1 In the **Home** toolbar, click  **Parameters** and choose **Add > Parameters**.
- 2 In the **Settings** window for **Parameters**, type Parameters 2: General in the **Label** text field.
- 3 Locate the **Parameters** section. Click  **Load from File**.



- 4 Browse to the model's Application Libraries folder and double-click the file `petzval_lens_parameters.txt`.

PETZVAL LENS

Insert the prepared geometry sequence from file. You can read the instructions for creating the geometry in the appendix. Following insertion, the lens definitions will be available in the **Parameters** node.

- 1 In the **Model Builder** window, under **Component 1 (comp1)** click **Geometry 1**.
- 2 In the **Settings** window for **Geometry**, locate the **Units** section.
- 3 From the **Length unit** list, choose **mm**.
- 4 In the **Label** text field, type `Petzval Lens`.
- 5 In the **Geometry** toolbar, click **Insert Sequence** and choose **Insert Sequence**.
- 6 Browse to the model's Application Libraries folder and double-click the file `petzval_lens_geom_sequence.mph`.
- 7 In the **Geometry** toolbar, click  **Build All**.
- 8 Click the  **Orthographic Projection** button in the **Graphics** toolbar.
- 9 In the **Graphics** window toolbar, click  next to  **Go to Default View**, then choose **Go to ZY View**. This will orient the view to place the optical axis (z -axis) horizontal and the y -axis vertical. Compare the resulting geometry to [Figure 2](#).

ADD MATERIAL

- 1 In the **Materials** toolbar, click  **Add Material** to open the **Add Material** window.
- 2 Go to the **Add Material** window.
- 3 In the tree, select **Optical > Schott Glass > Schott N-BK7 Glass**.
- 4 Click the **Add to Component** button in the window toolbar.
- 5 In the tree, select **Optical > Schott Glass > Schott N-KZF5 Glass**.
- 6 Click the **Add to Component** button in the window toolbar.
- 7 In the tree, select **Optical > Schott Glass > Schott N-SK2 Glass**.
- 8 Click the **Add to Component** button in the window toolbar.
- 9 In the tree, select **Optical > Schott Glass > Schott N-SF5 Glass**.
- 10 Click the **Add to Component** button in the window toolbar.
- 11 In the **Materials** toolbar, click  **Add Material** to close the **Add Material** window.

MATERIALS

Schott N-BK7 Glass (mat1)

- 1 In the **Settings** window for **Material**, locate the **Geometric Entity Selection** section.
- 2 From the **Selection** list, choose **Lens Material 1**.

Schott N-KZFS5 Glass (mat2)

- 1 In the **Model Builder** window, click **Schott N-KZFS5 Glass (mat2)**.
- 2 In the **Settings** window for **Material**, locate the **Geometric Entity Selection** section.
- 3 From the **Selection** list, choose **Lens Material 2**.

Schott N-SK2 Glass (mat3)

- 1 In the **Model Builder** window, click **Schott N-SK2 Glass (mat3)**.
- 2 In the **Settings** window for **Material**, locate the **Geometric Entity Selection** section.
- 3 From the **Selection** list, choose **Lens Material 3**.

Schott N-SF5 Glass (mat4)

- 1 In the **Model Builder** window, click **Schott N-SF5 Glass (mat4)**.
- 2 In the **Settings** window for **Material**, locate the **Geometric Entity Selection** section.
- 3 From the **Selection** list, choose **Lens Material 4**.

GEOMETRICAL OPTICS (GOP)

- 1 In the **Model Builder** window, under **Component 1 (comp1)** click **Geometrical Optics (gop)**.
- 2 In the **Settings** window for **Geometrical Optics**, locate the **Ray Release and Propagation** section.
- 3 From the **Wavelength distribution of released rays** list, choose **Polychromatic, specify vacuum wavelength**. The list of polychromatic wavelengths will be entered below.
- 4 In the **Maximum number of secondary rays** text field, type 0. In this simulation stray light is not being traced, so reflected rays will not be produced at the lens surfaces.
- 5 Locate the **Material Properties of Exterior and Unmeshed Domains** section. From the **Optical dispersion model** list, choose **Air, Edlen (1953)**. The lenses are assumed to be surrounded by air at room temperature.

Medium Properties 1

- 1 In the **Model Builder** window, under **Component 1 (comp1)** > **Geometrical Optics (gop)** click **Medium Properties 1**.
- 2 In the **Settings** window for **Medium Properties**, locate the **Medium Properties** section.

- From the **Refractive index of domains** list, choose **Get dispersion model from material**.
Each of the materials added above contain the optical dispersion coefficients which can be used to compute the refractive index as a function of wavelength.

Material Discontinuity I

- In the **Model Builder** window, click **Material Discontinuity I**.
- In the **Settings** window for **Material Discontinuity**, locate the **Rays to Release** section.
- From the **Release reflected rays** list, choose **Never**.

Release from Grid I

Release the rays from a hexapolar grid, using quantities defined in the **Parameters** node.

- In the **Physics** toolbar, click  **Global** and choose **Release from Grid**.
- In the **Settings** window for **Release from Grid**, locate the **Initial Coordinates** section.
- From the **Grid type** list, choose **Hexapolar**.
- Specify the \mathbf{q}_c vector as

dx1	x
dy1	y
dz	z

The **Center location** of the hexapolar grid will change according to the field angle.

- Specify the \mathbf{r}_c vector as

nix	x
niy	y
niz	z

The **Cylinder axis direction** is the same as the global optical axis.

- In the R_c text field, type $P_{\text{nom}}/2$.
- In the N_c text field, type N_{ring} .
- Locate the **Ray Direction Vector** section. Specify the \mathbf{L}_0 vector as

vx1	x
vy1	y
vz	z

The **Ray direction vector** is calculated using the field angles defined in the **Parameters** node.

9 Locate the **Vacuum Wavelength** section. From the **Distribution function** list, choose **List of values**.

10 In the **Values** text field, type 475[nm] 550[nm] 625[nm].

Release from Grid 2

1 Right-click **Release from Grid 1** and choose **Duplicate**.

2 In the **Settings** window for **Release from Grid**, locate the **Initial Coordinates** section.

3 Specify the \mathbf{q}_c vector as

dx2	x
dy2	y

4 Locate the **Ray Direction Vector** section. Specify the \mathbf{L}_0 vector as

vx2	x
vy2	y

Release from Grid 3

1 Right-click **Release from Grid 2** and choose **Duplicate**.

2 In the **Settings** window for **Release from Grid**, locate the **Initial Coordinates** section.

3 Specify the \mathbf{q}_c vector as

dx3	x
dy3	y

4 Locate the **Ray Direction Vector** section. Specify the \mathbf{L}_0 vector as

vx3	x
vy3	y

Obstructions

1 In the **Physics** toolbar, click  **Boundaries** and choose **Wall**.

2 In the **Settings** window for **Wall**, type Obstructions in the **Label** text field.

3 Locate the **Boundary Selection** section. From the **Selection** list, choose **Obstructions**.

4 Locate the **Wall Condition** section. From the **Wall condition** list, choose **Disappear**.

Stop

1 In the **Physics** toolbar, click  **Boundaries** and choose **Wall**.

2 In the **Settings** window for **Wall**, type Stop in the **Label** text field.

- 3 Locate the **Boundary Selection** section. From the **Selection** list, choose **Aperture Stop**.
- 4 Locate the **Wall Condition** section. From the **Wall condition** list, choose **Disappear**.

Image

- 1 In the **Physics** toolbar, click  **Boundaries** and choose **Wall**.
- 2 In the **Settings** window for **Wall**, type **Image** in the **Label** text field.
- 3 Locate the **Boundary Selection** section. From the **Selection** list, choose **Image Plane**.

MESH 1

In the **Model Builder** window, under **Component 1 (comp1)** right-click **Mesh 1** and choose **Build All**. The mesh should look like [Figure 3](#).

STUDY 1

Step 1: Ray Tracing

- 1 In the **Model Builder** window, under **Study 1** click **Step 1: Ray Tracing**.
- 2 In the **Settings** window for **Ray Tracing**, locate the **Study Settings** section.
- 3 From the **Time-step specification** list, choose **Specify maximum path length**.
- 4 From the **Length unit** list, choose **mm**.
- 5 In the **Lengths** text field, type 0 200. The maximum optical path length is sufficient for rays released at large field angles to reach the image plane.
- 6 In the **Study** toolbar, click  **Compute**.

RESULTS

Ray Diagram 1

Create a plot showing the ray trajectories, as well as a spot diagram showing the intersection of the rays with the image plane.

- 1 In the **Settings** window for **3D Plot Group**, type **Ray Diagram 1** in the **Label** text field.
- 2 Locate the **Color Legend** section. Select the **Show units** checkbox.
- 3 From the **Position** list, choose **Bottom**.
- 4 In the **Model Builder** window, expand the **Ray Diagram 1** node.

Color Expression 1

- 1 In the **Model Builder** window, expand the **Results > Ray Diagram 1 > Ray Trajectories 1** node, then click **Color Expression 1**.
- 2 In the **Settings** window for **Color Expression**, locate the **Expression** section.

3 In the **Expression** text field, type at ('last',gop.rre1). This is the radial coordinate relative to the centroid of each release feature at the image plane.

4 From the **Unit** list, choose **µm**.

Filter 1

1 In the **Model Builder** window, click **Filter 1**.

2 In the **Settings** window for **Filter**, locate the **Ray Selection** section.

3 From the **Rays to include** list, choose **Logical expression**.

4 In the **Logical expression for inclusion** text field, type at $(0, \text{abs}(\text{gop.deltaqx})) < 1 [\text{mm}]$.

Cut Plane 1

In the **Results** toolbar, click  **Cut Plane**.

Surface 1

1 In the **Model Builder** window, right-click **Ray Diagram 1** and choose **Surface**.

2 In the **Settings** window for **Surface**, locate the **Data** section.

3 From the **Dataset** list, choose **Cut Plane 1**.

4 Click **Replace Expression** in the upper-right corner of the **Expression** section. From the menu, choose **Component 1 (comp1) > Geometrical Optics > Refractive index > gop.nrefd - Refractive index, d-line - 1**.

5 Locate the **Coloring and Style** section. From the **Color table** list, choose **GrayScale**.

Line 1

1 Right-click **Ray Diagram 1** and choose **Line**.

2 In the **Settings** window for **Line**, locate the **Data** section.

3 From the **Dataset** list, choose **Cut Plane 1**.

4 From the **Time (s)** list, choose **0**.

5 Locate the **Coloring and Style** section. From the **Coloring** list, choose **Uniform**.

6 From the **Color** list, choose **Black**.

7 In the **Ray Diagram 1** toolbar, click  **Plot**. Compare the resulting image to [Figure 4](#).

Ray Diagram 2

For the second ray diagram the rays will be colored according to the radial distance from the ray's location in the image plane to the centroid. This makes it possible to visualize which rays are contributing to the image plane spot aberrations.

1 In the **Results** toolbar, click  **3D Plot Group**.

- 2 In the **Settings** window for **3D Plot Group**, type Ray Diagram 2 in the **Label** text field.
- 3 Locate the **Data** section. From the **Dataset** list, choose **Ray 1**.
- 4 Locate the **Plot Settings** section. From the **View** list, choose **New view**.
- 5 Locate the **Color Legend** section. Select the **Show units** checkbox.

Ray Trajectories 1

In the **Ray Diagram 2** toolbar, click  **More Plots** and choose **Ray Trajectories**.

Color Expression 1

- 1 Right-click **Ray Trajectories 1** and choose **Color Expression**.
- 2 In the **Settings** window for **Color Expression**, locate the **Expression** section.
- 3 In the **Expression** text field, type at ('last', gop.rre1). This is the radial coordinate relative to the centroid of each release feature at the image plane.
- 4 From the **Unit** list, choose **µm**.

Add a **Surface** plot to render the lens elements as solids.



Surface 1

- 1 In the **Model Builder** window, right-click **Ray Diagram 2** and choose **Surface**.
- 2 In the **Settings** window for **Surface**, locate the **Data** section.
- 3 From the **Dataset** list, choose **Study 1/Solution 1 (sol1)**.
- 4 Locate the **Coloring and Style** section. From the **Coloring** list, choose **Uniform**.
- 5 From the **Color** list, choose **Gray**.

Selection 1

- 1 Right-click **Surface 1** and choose **Selection**.
- 2 In the **Settings** window for **Selection**, locate the **Selection** section.
- 3 From the **Selection** list, choose **Lens Exteriors**.

Transparency 1

- 1 In the **Model Builder** window, right-click **Surface 1** and choose **Transparency**.
- 2 In the **Ray Diagram 2** toolbar, click  **Plot**.
- 3 Click the  **Orthographic Projection** button in the **Graphics** toolbar. Orient the view to match [Figure 5](#) to show the all the rays.

Spot Diagram

In the following steps, a spot diagram is created, and a custom color expression is added.



- 1 In the **Results** toolbar, click  **2D Plot Group**.

- 2 In the **Settings** window for **2D Plot Group**, type Spot Diagram in the **Label** text field.
- 3 Locate the **Color Legend** section. Select the **Show units** checkbox.

Spot Diagram 1

In the **Spot Diagram** toolbar, click  **More Plots** and choose **Spot Diagram**.

Color Expression 1

- 1 Right-click **Spot Diagram 1** and choose **Color Expression**.
- 2 In the **Settings** window for **Color Expression**, locate the **Expression** section.
- 3 In the **Expression** text field, type `gop.lambda0`.
- 4 From the **Unit** list, choose **nm**.
- 5 Click to expand the **Range** section. Select the **Manual color range** checkbox.
- 6 In the **Minimum** text field, type 450.
- 7 In the **Maximum** text field, type 650.
- 8 In the **Spot Diagram** toolbar, click  **Plot**.
- 9 Click the  **Zoom Extents** button in the **Graphics** toolbar. Compare the resulting image to [Figure 6](#).



Appendix — Geometry Instructions

From the **File** menu, choose **New**.

NEW

In the **New** window, click  **Model Wizard**.

MODEL WIZARD

- 1 In the **Model Wizard** window, click  **3D**.
- 2 Click  **Done**.

GLOBAL DEFINITIONS

The detailed parameters of the lens can be imported from a text file. The prescription for the Petzval lens with a field flattener can be found in [Ref. 1](#), pg 192.

Parameters 1

- 1 In the **Model Builder** window, under **Global Definitions** click **Parameters 1**.
- 2 In the **Settings** window for **Parameters**, locate the **Parameters** section.
- 3 Click  **Load from File**.

- 4 Browse to the model's Application Libraries folder and double-click the file `petzval_lens_geom_sequence_parameters.txt`.

Petzval Lens Parameters

The parameters that define the Petzval lens geometric sequence are found in `petzval_lens_geom_sequence_parameters.txt`. These will be described in the tables below.

- 1 First, define the global optical axis. This is used to orient the first lens only. The orientation of each subsequent lens will be relative to the preceding one.

Parameter	Description
<code>nix</code>	Global optical axis, x-component
<code>niy</code>	Global optical axis, y-component
<code>niz</code>	Global optical axis, z-component

- 2 Next, define the parameters for each of the lens elements. Each lens requires 8 parameters in addition to the ray incident directions (which are set using the global values).

Parameter	Description
<code>R1_[n]</code>	Radius of curvature, surface 1, lens [n]
<code>R2_[n]</code>	Radius of curvature, surface 2, lens [n]
<code>Tc_[n]</code>	Center thickness, lens [n]
<code>d0_[n]</code>	Outer diameter, lens [n]
<code>d1_[n]</code>	Diameter, surface 1, lens [n]
<code>d2_[n]</code>	Diameter, surface 2, lens [n]
<code>d1_clear_[n]</code>	Clear aperture diameter, surface 1, lens [n]
<code>d2_clear_[n]</code>	Clear aperture diameter, surface 2, lens [n]

- 3 Finally, define the remaining lens parameters.

Parameter	Description
<code>T_[n]</code>	Distance between lenses [n] and [n+1].
<code>d0_S</code>	Stop maximum (outer) diameter
<code>d1_S</code>	Stop minimum (clear) diameter
<code>d0_D</code>	Diameter of image plane



PETZVAL LENS GEOMETRY SEQUENCE

Start constructing the lens geometry.

- 1 In the **Model Builder** window, under **Component 1 (comp1)** click **Geometry 1**.
- 2 In the **Settings** window for **Geometry**, type Petzval Lens Geometry Sequence in the **Label** text field.
- 3 Locate the **Units** section. From the **Length unit** list, choose **mm**.





Insert the first of the Petzval Lens elements.

PART LIBRARIES

- 1 In the **Geometry** toolbar, click  **Part Libraries**.
- 2 In the **Part Libraries** window, select **Ray Optics Module > 3D > Spherical Lenses > spherical_lens_3d** in the tree.
- 3 Click  **Add to Geometry**.
- 4 In the **Select Part Variant** dialog, select **Specify clear aperture diameter** in the **Select part variant** list.
- 5 Click **OK**. This part is used for each of the 5 Petzval Lens elements.

PETZVAL LENS GEOMETRY SEQUENCE

Lens 1

- 1 In the **Model Builder** window, under **Component 1 (comp1)** > **Petzval Lens Geometry Sequence** click **Spherical Lens 3D 1 (pi1)**.
- 2 In the **Settings** window for **Part Instance**, type Lens 1 in the **Label** text field.
- 3 Locate the **Input Parameters** section. Click  **Load from File**.
- 4 Browse to the model's Application Libraries folder and double-click the file petzval_lens_geom_sequence_lens1.txt. The files petzval_lens_geom_sequence_lens m .txt, where $m=1, \dots, 5$, contain references to each of the individual lens parameters. This avoids having to enter the values manually. Note that the z -axis is the optical axis throughout this geometry; that is, $n_{ix}=n_{iy}=0$, $n_{iz}=1$.
- 5 Click  **Build Selected**.
- 6 Click the  **Orthographic Projection** button in the **Graphics** toolbar.
- 7 In the **Graphics** window toolbar, click  next to  **Go to Default View**, then choose **Go to ZY View**. This will orient it to place the optical axis (that is, the z -axis) horizontally and the y -axis vertically.

Create cumulative selections defining the materials, clear apertures, obstructions, and image plane that can be used within the final ray trace.

Cumulative Selections

In the **Geometry** toolbar, click  **Selections** and choose **Cumulative Selections**.

Lens Material 1

- 1 Right-click **Cumulative Selections** and choose **Cumulative Selection**.
- 2 In the **Settings** window for **Selection**, type Lens Material 1 in the **Label** text field.

Lens Material 2

- 1 In the **Model Builder** window, right-click **Cumulative Selections** and choose **Cumulative Selection**.
- 2 In the **Settings** window for **Selection**, type Lens Material 2 in the **Label** text field. In the same manner, add selections for Lens Material 3, Lens Material 4, Lens Exteriors, Clear Apertures, Obstructions, Aperture Stop, and Image Plane.

Lens 1 (p1)

Now, apply these selections.

- 1 In the **Model Builder** window, under **Component 1 (comp1) > Petzval Lens Geometry Sequence** click **Lens 1 (p1)**.
- 2 In the **Settings** window for **Part Instance**, click to expand the **Domain Selections** section.
- 3 In the table, enter the following settings:



Name	Keep	Physics	Contribute to
All		√	Lens Material 1

- 4 Click to expand the **Boundary Selections** section. In the table, enter the following settings:

Name	Keep	Physics	Contribute to
Exterior		√	Lens Exteriors
Surface 1		√	Clear Apertures
Surface 2		√	Clear Apertures
Surface 1 obstruction		√	Obstructions
Surface 2 obstruction		√	Obstructions
Edges		√	Obstructions

Lens 2

Continue constructing the lens. Add the second lens element.

- 1 In the **Geometry** toolbar, click  **Part Instance** and choose **Spherical Lens 3D**.
- 2 In the **Settings** window for **Part Instance**, type Lens 2 in the **Label** text field.
- 3 Locate the **Input Parameters** section. Click  **Load from File**.
- 4 Browse to the model's Application Libraries folder and double-click the file petzval_lens_geom_sequence_lens2.txt.
Each lens element can be positioned in the geometry by referencing it to an existing work plane. For this example, use a work plane that is defined by the vertex on the exit surface of the prior lens element.
- 5 Locate the **Position and Orientation of Output** section. Find the **Coordinate system to match** subsection. From the **Take work plane from** list, choose **Lens 1 (pi1)**.
- 6 From the **Work plane** list, choose **Surface 2 vertex intersection (wp2)**.
- 7 Find the **Displacement** subsection. In the **zwi** text field, type T_1 . This is the distance along the optical axis between the exit surface of lens 1 and the entrance surface of lens 2.
- 8 Locate the **Domain Selections** section. In the table, enter the following settings:

Name	Keep	Physics	Contribute to
All		√	Lens Material 2

- 9 Locate the **Boundary Selections** section. In the table, enter the following settings:

Name	Keep	Physics	Contribute to
Exterior		√	Lens Exteriors
Surface 1		√	Clear Apertures
Surface 2		√	Clear Apertures
Surface 1 obstruction		√	Obstructions
Surface 2 obstruction		√	Obstructions
Edges		√	Obstructions

PART LIBRARIES

Next, insert the stop.

- 1 In the **Geometry** toolbar, click  **Part Libraries**.

- 2 In the **Part Libraries** window, select **Ray Optics Module > 3D > Apertures and Obstructions > circular_planar_annulus** in the tree.
- 3 Click  **Add to Geometry**. This part is also used to define the image plane and additional obstructions.

PETZVAL LENS GEOMETRY SEQUENCE

Stop

- 1 In the **Model Builder** window, under **Component 1 (comp1) > Petzval Lens Geometry Sequence** click **Circular Planar Annulus 1 (pi3)**.
- 2 In the **Settings** window for **Part Instance**, type **Stop** in the **Label** text field.
- 3 Locate the **Input Parameters** section. In the table, enter the following settings:



Name	Expression	Value	Description
d0	d0_S	58 mm	Diameter, outer
d1	d1_S	33.262 mm	Diameter, inner
nix	0	0	Local optical axis, x-component
niy	0	0	Local optical axis, y-component
niz	1	1	Local optical axis, z-component

- 4 Locate the **Position and Orientation of Output** section. Find the **Coordinate system to match** subsection. From the **Take work plane from** list, choose **Lens 2 (pi2)**.
- 5 From the **Work plane** list, choose **Surface 2 vertex intersection (wp2)**.
- 6 Find the **Displacement** subsection. In the **zwi** text field, type **T_2+Tc_3**.
- 7 Locate the **Boundary Selections** section. In the table, enter the following settings:

Name	Keep	Physics	Contribute to
All		<input checked="" type="checkbox"/>	Aperture Stop

Lens 3

The remaining lenses are similarly defined. Next, add the third lens element.

- 1 In the **Geometry** toolbar, click  **Part Instance** and choose **Spherical Lens 3D**.
- 2 In the **Settings** window for **Part Instance**, type **Lens 3** in the **Label** text field.
- 3 Locate the **Input Parameters** section. Click  **Load from File**.
- 4 Browse to the model's Application Libraries folder and double-click the file **petzval_lens_geom_sequence_lens3.txt**.

- 5 Locate the **Position and Orientation of Output** section. Find the **Coordinate system to match** subsection. From the **Take work plane from** list, choose **Stop (pi3)**.
- 6 From the **Work plane** list, choose **Surface (wp1)**.
- 7 Find the **Displacement** subsection. In the **zwi** text field, type T_3.
- 8 Locate the **Domain Selections** section. In the table, enter the following settings:



Name	Keep	Physics	Contribute to
All		√	Lens Material 3

- 9 Locate the **Boundary Selections** section. In the table, enter the following settings:

Name	Keep	Physics	Contribute to
Exterior		√	Lens Exteriors
Surface 1		√	Clear Apertures
Surface 2		√	Clear Apertures
Surface 1 obstruction		√	Obstructions
Surface 2 obstruction		√	Obstructions
Edges		√	Obstructions

Lens 4

Next, add the fourth lens element.

- 1 In the **Geometry** toolbar, click  **Part Instance** and choose **Spherical Lens 3D**.
- 2 In the **Settings** window for **Part Instance**, type Lens 4 in the **Label** text field.
- 3 Locate the **Input Parameters** section. Click  **Load from File**.
- 4 Browse to the model's Application Libraries folder and double-click the file petzval_lens_geom_sequence_lens4.txt.
- 5 Locate the **Position and Orientation of Output** section. Find the **Coordinate system to match** subsection. From the **Take work plane from** list, choose **Lens 3 (pi4)**.
- 6 From the **Work plane** list, choose **Surface 2 vertex intersection (wp2)**.
- 7 Find the **Displacement** subsection. In the **zwi** text field, type T_4.
- 8 Locate the **Domain Selections** section. In the table, enter the following settings:



Name	Keep	Physics	Contribute to
All		√	Lens Material 4

9 Locate the **Boundary Selections** section. In the table, enter the following settings:

Name	Keep	Physics	Contribute to
Exterior		√	Lens Exteriors
Surface 1		√	Clear Apertures
Surface 2		√	Clear Apertures
Surface 1 obstruction		√	Obstructions
Surface 2 obstruction		√	Obstructions
Edges		√	Obstructions

Lens 5

Now, add the fifth and last lens element. This element gives the Petzval a flat image plane.

- 1 In the **Geometry** toolbar, click  **Part Instance** and choose **Spherical Lens 3D**.
- 2 In the **Settings** window for **Part Instance**, type Lens 5 in the **Label** text field.
- 3 Locate the **Input Parameters** section. Click  **Load from File**.
- 4 Browse to the model's Application Libraries folder and double-click the file petzval_lens_geom_sequence_lens5.txt.
- 5 Locate the **Position and Orientation of Output** section. Find the **Coordinate system to match** subsection. From the **Take work plane from** list, choose **Lens 4 (pi5)**.
- 6 From the **Work plane** list, choose **Surface 2 vertex intersection (wp2)**.
- 7 Find the **Displacement** subsection. In the **zwi** text field, type T_5.
- 8 Locate the **Domain Selections** section. In the table, enter the following settings:



Name	Keep	Physics	Contribute to
All		√	Lens Material 4

9 Locate the **Boundary Selections** section. In the table, enter the following settings:

Name	Keep	Physics	Contribute to
Exterior		√	Lens Exteriors
Surface 1		√	Clear Apertures
Surface 2		√	Clear Apertures
Surface 1 obstruction		√	Obstructions
Surface 2 obstruction		√	Obstructions
Edges		√	Obstructions

PART LIBRARIES

Define the square image plane.

- 1 In the **Geometry** toolbar, click  **Part Libraries**.
- 2 In the **Part Libraries** window, select **Ray Optics Module > 3D > Apertures and Obstructions > rectangular_planar_annulus** in the tree.
- 3 Click  **Add to Geometry**.

PETZVAL LENS GEOMETRY SEQUENCE

Image

- 1 In the **Model Builder** window, under **Component 1 (comp1) > Petzval Lens Geometry Sequence** click **Rectangular Planar Annulus 1 (pi7)**.
- 2 In the **Settings** window for **Part Instance**, type **Image** in the **Label** text field.
- 3 Locate the **Input Parameters** section. In the table, enter the following settings:

Name	Expression	Value	Description
w0	d0_D	35.808 mm	Width, outer
h0	d0_D	35.808 mm	Height, outer
w1	0	0 m	Width, inner
h1	0	0 m	Height, inner
nix	0	0	Local optical axis, x-component
niy	0	0	Local optical axis, y-component
niz	1	l	Local optical axis, z-component
nwx	1	l	Rectangle width direction, x-component
nwy	0	0	Rectangle width direction, y-component
nwz	0	0	Rectangle width direction, z-component

- 4 Locate the **Position and Orientation of Output** section. Find the **Coordinate system to match** subsection. From the **Take work plane from** list, choose **Lens 5 (pi6)**.
- 5 From the **Work plane** list, choose **Surface 2 vertex intersection (wp2)**.
- 6 Find the **Displacement** subsection. In the **zwi** text field, type **T_6**.
- 7 Locate the **Boundary Selections** section. In the table, enter the following settings:

Name	Keep	Physics	Contribute to
All		√	Image Plane

8 Click  **Build All Objects**.

9 Click the  **Zoom Extents** button in the **Graphics** toolbar.

Create a selection that includes all lenses. This can be used to define physics features.

All Lenses

1 In the **Geometry** toolbar, click  **Selections** and choose **Explicit Selection**.

2 In the **Settings** window for **Explicit Selection**, type All Lenses in the **Label** text field.

3 On the object **pi1**, select Domain 1 only.

4 On the object **pi2**, select Domain 1 only.

5 On the object **pi4**, select Domain 1 only.

6 On the object **pi5**, select Domain 1 only.

7 On the object **pi6**, select Domain 1 only.

Petzval Lens Apertures

The following commands are used to insert each of the lens apertures. The annulus clear aperture diameters are determined by the outer diameter of the current lens element. Each lens aperture is positioned at either the entrance or exit lens surface edges.

Group 1 Aperture

1 In the **Geometry** toolbar, click  **Part Instance** and choose **Circular Planar Annulus**.

2 In the **Settings** window for **Part Instance**, type Group 1 Aperture in the **Label** text field.

3 Locate the **Input Parameters** section. In the table, enter the following settings:

Name	Expression	Value	Description
d0	$1.25 * d0_1$	72.5 mm	Diameter, outer
d1	d0_1	58 mm	Diameter, inner
nix	0	0	Local optical axis, x-component
niy	0	0	Local optical axis, y-component
niz	1	1	Local optical axis, z-component

4 Locate the **Position and Orientation of Output** section. Find the **Coordinate system to match** subsection. From the **Take work plane from** list, choose **Lens 1 (pi1)**.

5 From the **Work plane** list, choose **Surface 1 edge (wp3)**.

6 Locate the **Boundary Selections** section. In the table, enter the following settings:

Name	Keep	Physics	Contribute to
All		√	Obstructions

Group 2 Aperture

- 1 In the **Geometry** toolbar, click  **Part Instance** and choose **Circular Planar Annulus**.
- 2 In the **Settings** window for **Part Instance**, type Group 2 Aperture in the **Label** text field.
- 3 Locate the **Input Parameters** section. In the table, enter the following settings:

Name	Expression	Value	Description
d0	$1.25 * d0_4$	56.25 mm	Diameter, outer
d1	d0_4	45 mm	Diameter, inner
nix	0	0	Local optical axis, x-component
niy	0	0	Local optical axis, y-component
niz	1	1	Local optical axis, z-component

- 4 Locate the **Position and Orientation of Output** section. Find the **Coordinate system to match** subsection. From the **Take work plane from** list, choose **Lens 3 (pi4)**.
- 5 From the **Work plane** list, choose **Surface 1 edge (wp3)**.
- 6 Locate the **Boundary Selections** section. In the table, enter the following settings:

Name	Keep	Physics	Contribute to
All		√	Obstructions

Group 3 Aperture

- 1 In the **Geometry** toolbar, click  **Part Instance** and choose **Circular Planar Annulus**.
- 2 In the **Settings** window for **Part Instance**, type Group 3 Aperture in the **Label** text field.
- 3 Locate the **Input Parameters** section. In the table, enter the following settings:

Name	Expression	Value	Description
d0	$1.25 * d0_6$	53.125 mm	Diameter, outer
d1	d0_6	42.5 mm	Diameter, inner
nix	0	0	Local optical axis, x-component
niy	0	0	Local optical axis, y-component
niz	1	1	Local optical axis, z-component

- 4 Locate the **Position and Orientation of Output** section. Find the **Coordinate system to match** subsection. From the **Take work plane from** list, choose **Lens 5 (pi6)**.
- 5 From the **Work plane** list, choose **Surface 1 edge (wp3)**.
- 6 Locate the **Boundary Selections** section. In the table, enter the following settings:

Name	Keep	Physics	Contribute to
All		√	Obstructions

- 7 In the **Geometry** toolbar, click  **Build All**. Compare the resulting image to [Figure 2](#).