



Model created in COMSOL Multiphysics 6.4

# Hubble Space Telescope

## Introduction

---

The Hubble Space Telescope (HST) is an example of a Cassegrain telescope. This tutorial demonstrates how to use the *Conic Mirror On Axis 3D* part from the Part Libraries to construct the HST Ritchey–Chrétien geometry, and how to include multiple ray release features so that rays at several field angles can be traced simultaneously. An overview of the HST is shown in [Figure 1](#).

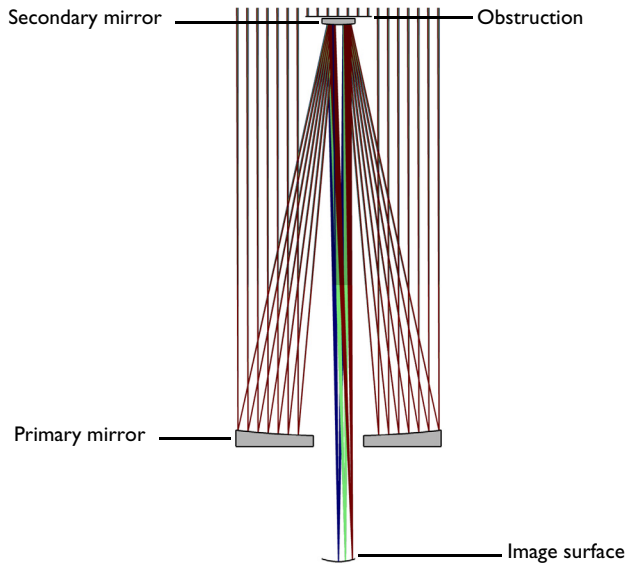

Figure 1: Overview of the Hubble Space Telescope.

## Model Definition

---

Details of the Hubble Space Telescope can be found in [Ref. 1](#) and [Ref. 2](#). This is the nominal prelaunch design. In this tutorial the as-built details (see, for example, [Ref. 3](#) and [Ref. 4](#)) are not considered, but additional information from these references was used to create the model. A summary of the HST parameters used in this tutorial is given in [Table 1](#).

In this simulation the telescope geometry is constructed using two instances of the *Conic Mirror On Axis 3D* from the Part Libraries. The image surface is defined using a **Parametric Surface** primitive with the appropriate Petzval curvature. A secondary obstruction has been created using an instance of the *Circular Planar Annulus 3D* which can also be found in the Part Libraries. The resulting geometry sequence is shown in [Figure 2](#).

TABLE 1: HUBBLE SPACE TELESCOPE PARAMETERS.

<b>Name</b>	<b>Value</b>	<b>Details</b>
$\lambda_{\text{vac}}$	550 nm	Vacuum wavelength
$\theta_{x,i}$	0', 5', 10'	Nominal $x$ field angle, field $i = 1,2,3$
$\theta_{y,i}$	0', 0', 0'	Nominal $y$ field angle, field $i = 1,2,3$
$N_{\text{ring}}$	10	Number of hexapolar rings
$P_{\text{nom}}$	2400.0 mm	Entrance pupil diameter
Primary mirror:		
$R_{\text{prim}}$	-11040.0 mm	Primary mirror radius of curvature
$k_{\text{prim}}$	-1.0022985	Primary mirror conic constant
$d_{0,\text{prim}}$	2450.0 mm	Primary mirror full diameter (nominal)
$d_{h,\text{prim}}$	600.0 mm	Primary mirror central hole diameter
$T_{c,\text{prim}}$	125.0 mm	Primary mirror center thickness (nominal)
Secondary mirror:		
$R_{\text{sec}}$	1358.000 mm	Secondary mirror radius of curvature
$k_{\text{sec}}$	-1.49600	Secondary mirror conic constant
$d_{\text{sec}}$	395.0 mm	Secondary mirror diameter
$T_{c,\text{sec}}$	75.0 mm	Secondary mirror center thickness (nominal)
Positions:		
$Z_{\text{prim}}$	0 mm	Primary mirror position
$Z_{\text{sec}}$	-4906.071 mm	Secondary mirror position
$Z_{\text{bfl}}$	1500.0 mm	Image surface back focal length (relative to primary vertex)
$Z_{\text{image}}$	$Z_{\text{sec}} - Z_{\text{bfl}}$	Image surface position (relative to secondary surface)
Misc:		
$\epsilon_{\text{obs}}$	0.33	Obstruction fraction
$C_p$	$2\left(\frac{1}{R_{\text{sec}}} - \frac{1}{R_{\text{prim}}}\right)$	Image surface Petzval curvature

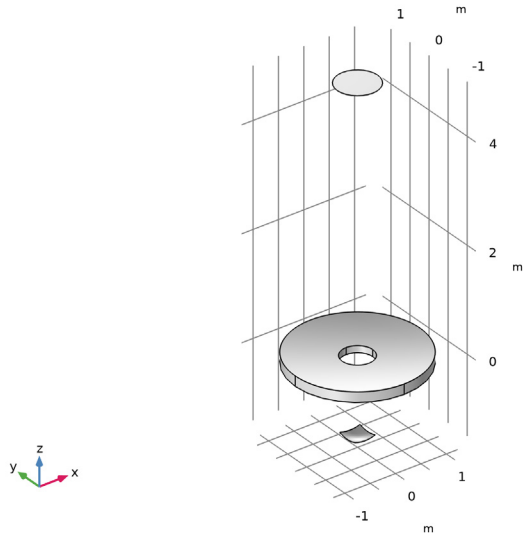

Figure 2: The Hubble Space Telescope geometry sequence.

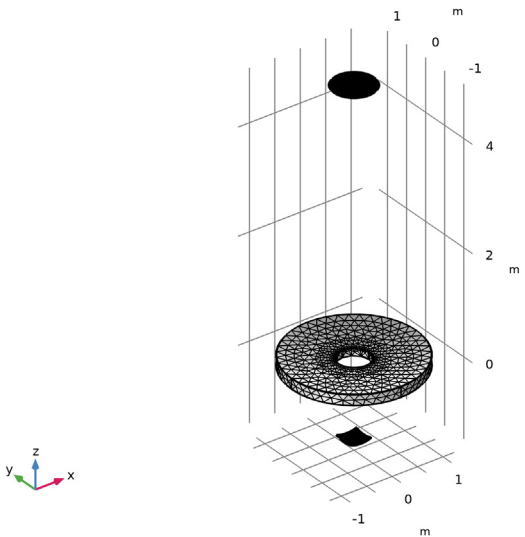
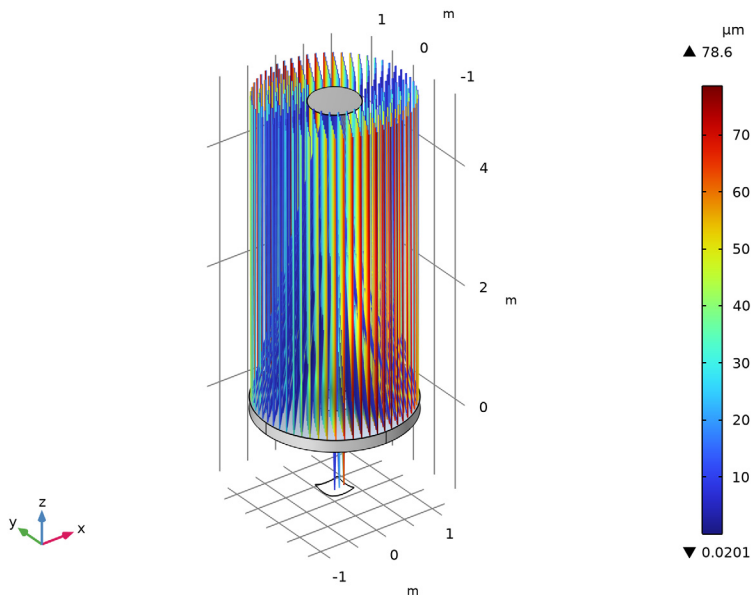

Figure 3: The Hubble Space Telescope mesh.

## Results and Discussion

A ray trace has been performed at a single wavelength (550 nm) at three field angles (0, 5 and 10 arcminutes). [Figure 4](#) shows the resulting ray trajectories; the **Color Expression** represents the ray positions on the image surface.

In [Figure 5](#) the intersection of the rays with the image surface is shown. This spot diagram shows each of the three field angles, where the **Color Expression** is the initial radial location at the entrance pupil.



*Figure 4: Ray diagram of the HST colored by radial distance from the centroid.*

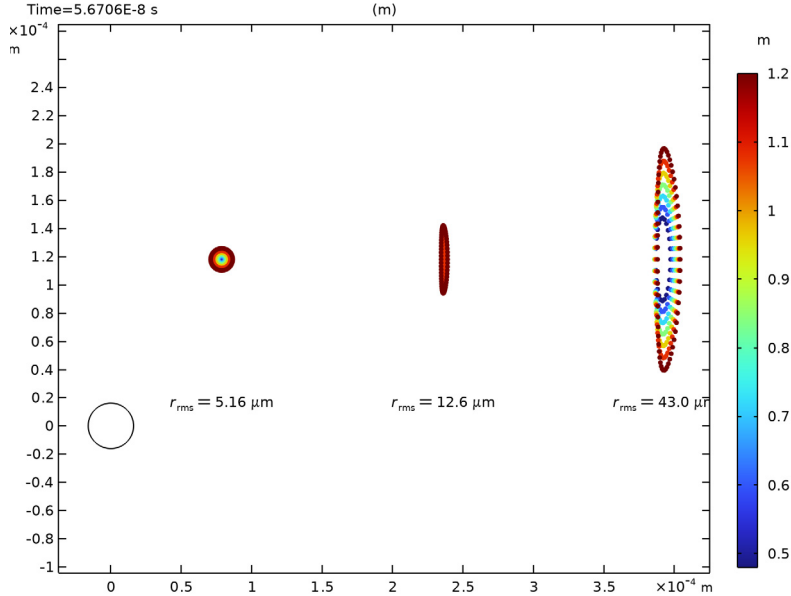

Figure 5: Spot diagram of the HST colored by radial distance from the center of the entrance pupil. The absolute coordinate of each spot is shown. The ring in the lower-left corner is the nominal Airy ring.

## References

1. C. Burrows, *Hubble Space Telescope: Optical telescope assembly handbook*. Space Telescope Science Inst., Baltimore, MD, 1990.
2. D. Schroeder, *Astronomical Optics*. Second Edition. San Diego, CA, USA: Academic Press, 2000.
3. D. Moore and others, *Final Report Hubble Independent Optical Review Panel*. Goddard Space Flight Center, Greenbelt, MD, 1991.
4. L. Allen and others, *The Hubble Space Telescope Optical Systems Failure Report*. NASA, 1990.

---

**Application Library path:** Ray\_Optics\_Module/Lenses\_Cameras\_and\_Telescopes/  
hubble\_space\_telescope

---

## Modeling Instructions



---

From the **File** menu, choose **New**.

### NEW

In the **New** window, click  **Model Wizard**.

### MODEL WIZARD



- 1 In the **Model Wizard** window, click  **3D**.
- 2 In the **Select Physics** tree, select **Optics** > **Ray Optics** > **Geometrical Optics (gop)**.
- 3 Click **Add**.
- 4 Click  **Study**.
- 5 In the **Select Study** tree, select **Preset Studies for Selected Physics Interfaces** > **Ray Tracing**.
- 6 Click  **Done**.

### GLOBAL DEFINITIONS

#### *Parameters I*

- 1 In the **Model Builder** window, under **Global Definitions** click **Parameters I**.
- 2 In the **Settings** window for **Parameters**, locate the **Parameters** section.
- 3 Click  **Load from File**.
- 4 Browse to the model's Application Libraries folder and double-click the file `hubble_space_telescope_parameters.txt`.

### PART LIBRARIES

- 1 In the **Geometry** toolbar, click  **Part Libraries**.
- 2 In the **Model Builder** window, under **Component I (comp1)** click **Geometry I**.
- 3 In the **Part Libraries** window, select **Ray Optics Module** > **3D** > **Mirrors** > **conic\_mirror\_on\_axis\_3d** in the tree.
- 4 Click  **Add to Geometry**.
- 5 In the **Select Part Variant** dialog, select **Specify clear aperture diameter** in the **Select part variant** list.
- 6 Click **OK**.

## GEOMETRY I

### Primary Mirror

- 1 In the **Model Builder** window, under **Component 1 (comp1) > Geometry I** click **Conic Mirror On Axis 3D I (pi1)**.
- 2 In the **Settings** window for **Part Instance**, type **Primary Mirror** in the **Label** text field.
- 3 Locate the **Input Parameters** section. In the table, enter the following settings:

Name	Expression	Value	Description
R	R_prim	-11.04 m	Radius of curvature (+convex/-concave)
k	k_prim	-1.0023	Conic constant
Tc	Tc_prim	0.125 m	Center thickness
d0	d0_prim	2.45 m	Mirror full diameter
d1	0	0 m	Mirror surface diameter
d_clear	0	0 m	Clear aperture diameter
d_hole	dh_prim	0.6 m	Center hole diameter
nix	nix	0	Local optical axis, x-component
niy	niy	0	Local optical axis, y-component
niz	niz	-1	Local optical axis, z-component
n_extra_a	np_extra	10	Number of extra azimuthal points

- 4 Locate the **Position and Orientation of Output** section. Find the **Displacement** subsection. In the **zwi** text field, type **Z\_prim**.
- 5 Click  **Build Selected**.
- 6 Click to expand the **Boundary Selections** section. In the table, select the **Keep** checkbox for **Mirror surface**.
- 7 Click to select row number 3 in the table.
- 8 Click **New Cumulative Selection**.
- 9 In the **New Cumulative Selection** dialog, type **Obstructions** in the **Name** text field.
- 10 Click **OK**.
- 11 In the **Settings** window for **Part Instance**, locate the **Boundary Selections** section.

12 In the table, enter the following settings:

Name	Keep	Physics	Contribute to
Mirror rear surface		√	Obstructions
Mirror edges		√	Obstructions

### Secondary Mirror

- 1 In the **Geometry** toolbar, click  **Part Instance** and choose **Conic Mirror On Axis 3D**.
- 2 In the **Settings** window for **Part Instance**, type Secondary Mirror in the **Label** text field.
- 3 Locate the **Input Parameters** section. In the table, enter the following settings:

Name	Expression	Value	Description
R	R_sec	1.358 m	Radius of curvature (+convex/-concave)
k	k_sec	-1.496	Conic constant
Tc	Tc_sec	0.075 m	Center thickness
d0	d_sec	0.395 m	Mirror full diameter
dI	0	0 m	Mirror surface diameter
d_clear	0	0 m	Clear aperture diameter
d_hole	0	0 m	Center hole diameter

- 4 Locate the **Position and Orientation of Output** section. Find the **Coordinate system to match** subsection. From the **Take work plane from** list, choose **Primary Mirror (p1)**.
- 5 From the **Work plane** list, choose **Mirror vertex intersection (wp1)**.
- 6 Find the **Displacement** subsection. In the **zwi** text field, type Z\_sec.
- 7 Click  **Build Selected**.
- 8 Locate the **Boundary Selections** section. In the table, enter the following settings:

Name	Keep	Physics	Contribute to
Mirror surface	√	√	None
Mirror rear surface		√	Obstructions
Mirror edges		√	Obstructions

### Image Surface



A parametric surface can be used to define the image surface.

- 1 In the **Geometry** toolbar, click  **More Primitives** and choose **Parametric Surface**.

- 2 In the **Settings** window for **Parametric Surface**, type Image Surface in the **Label** text field.
- 3 Locate the **Parameters** section. Find the **First parameter** subsection. In the **Minimum** text field, type -hw\_image.
- 4 In the **Maximum** text field, type hw\_image.
- 5 Find the **Second parameter** subsection. In the **Minimum** text field, type -hw\_image.
- 6 In the **Maximum** text field, type hw\_image.
- 7 Locate the **Expressions** section. In the **x** text field, type s1.
- 8 In the **y** text field, type s2.
- 9 In the **z** text field, type  $Cp*(s1^2 + s2^2)/(1 + \sqrt{1 - Cp^2*(s1^2 + s2^2)})$ \* 1[m]. This is the equation of a sphere having a curvature Cp. This is the Petzval curvature defined in the Parameters node.
- 10 Locate the **Position** section. In the **z** text field, type Z\_image.
- 11 Locate the **Coordinate System** section. From the **Take work plane from** list, choose **Secondary Mirror (pi2)**.
- 12 From the **Work plane** list, choose **Mirror vertex intersection (wp1)**.
- 13 Locate the **Selections of Resulting Entities** section. Select the **Resulting objects selection** checkbox.

## PART LIBRARIES

The secondary mirror mount creates an obstruction.

- 1 In the **Geometry** toolbar, click  **Part Libraries**.
- 2 In the **Model Builder** window, click **Geometry I**.
- 3 In the **Part Libraries** window, select **Ray Optics Module > 3D > Apertures and Obstructions > circular\_planar\_annulus** in the tree.
- 4 Click  **Add to Geometry**.

## GEOMETRY I

### *Secondary Obstruction*

- 1 In the **Model Builder** window, under **Component I (comp1) > Geometry I** click **Circular Planar Annulus I (pi3)**.
- 2 In the **Settings** window for **Part Instance**, type Secondary Obstruction in the **Label** text field.

3 Locate the **Input Parameters** section. In the table, enter the following settings:

Name	Expression	Value	Description
d0	d0_obs	0.792 m	Diameter, outer
dI	0	0 m	Diameter, inner

4 Locate the **Position and Orientation of Output** section. Find the **Coordinate system to match** subsection. From the **Take work plane from** list, choose **Secondary Mirror (pi2)**.

5 From the **Work plane** list, choose **Mirror vertex intersection (wpI)**.

6 Find the **Displacement** subsection. In the **zwi** text field, type **Z\_obs**.

7 Locate the **Boundary Selections** section. In the table, enter the following settings:

Name	Keep	Physics	Contribute to
All		√	Obstructions

8 Click  **Build Selected**.

9 Click the  **Go to Default View** button in the **Graphics** toolbar.

10 Click the  **Orthographic Projection** button in the **Graphics** toolbar.

11 Click the  **Zoom Extents** button in the **Graphics** toolbar. Compare the resulting geometry to [Figure 2](#).

## GEOMETRICAL OPTICS (GOP)

1 In the **Model Builder** window, under **Component I (compI)** click **Geometrical Optics (gop)**.

2 In the **Settings** window for **Geometrical Optics**, locate the **Domain Selection** section.

3 Click  **Clear Selection**.

4 Locate the **Ray Release and Propagation** section. In the **Maximum number of secondary rays** text field, type **0**.

### Primary

1 In the **Physics** toolbar, click  **Boundaries** and choose **Mirror**.

2 In the **Settings** window for **Mirror**, type **Primary** in the **Label** text field.

3 Locate the **Boundary Selection** section. From the **Selection** list, choose **Mirror surface (Primary Mirror)**.

### Secondary

1 In the **Physics** toolbar, click  **Boundaries** and choose **Mirror**.

- 2 In the **Settings** window for **Mirror**, type Secondary in the **Label** text field.
- 3 Locate the **Boundary Selection** section. From the **Selection** list, choose **Mirror surface (Secondary Mirror)**.

#### *Obstructions*

- 1 In the **Physics** toolbar, click  **Boundaries** and choose **Wall**.
- 2 In the **Settings** window for **Wall**, type Obstructions in the **Label** text field.
- 3 Locate the **Boundary Selection** section. From the **Selection** list, choose **Obstructions**.
- 4 Locate the **Wall Condition** section. From the **Wall condition** list, choose **Disappear**.

#### *Image*

- 1 In the **Physics** toolbar, click  **Boundaries** and choose **Wall**.
- 2 In the **Settings** window for **Wall**, type Image in the **Label** text field.
- 3 Locate the **Boundary Selection** section. From the **Selection** list, choose **Image Surface**.

#### *Release from Grid 1*

Next, create three release features for each of the field angles defined in the Parameters node.

- 1 In the **Physics** toolbar, click  **Global** and choose **Release from Grid**.
- 2 In the **Settings** window for **Release from Grid**, locate the **Initial Coordinates** section.
- 3 From the **Grid type** list, choose **Hexapolar**.
- 4 Specify the  $\mathbf{q}_c$  vector as

-dx1	x
-dy1	y
dz	z

- 5 Specify the  $\mathbf{r}_c$  vector as

0	x
0	y
1	z

- 6 In the  $R_c$  text field, type P\_nom/2.
- 7 In the  $N_c$  text field, type N\_ring.

**8** Locate the **Ray Direction Vector** section. Specify the  $\mathbf{L}_0$  vector as

vx1	x
vy1	y
-vz	z

*Release from Grid 2*

**1** Right-click **Release from Grid 1** and choose **Duplicate**.

**2** In the **Settings** window for **Release from Grid**, locate the **Initial Coordinates** section.

**3** Specify the  $\mathbf{q}_c$  vector as

-dx2	x
-dy2	y

**4** Locate the **Ray Direction Vector** section. Specify the  $\mathbf{L}_0$  vector as

vx2	x
vy2	y

*Release from Grid 3*

**1** Right-click **Release from Grid 2** and choose **Duplicate**.

**2** In the **Settings** window for **Release from Grid**, locate the **Initial Coordinates** section.

**3** Specify the  $\mathbf{q}_c$  vector as

-dx3	x
-dy3	y

**4** Locate the **Ray Direction Vector** section. Specify the  $\mathbf{L}_0$  vector as

vx3	x
vy3	y

## **MESH 1**

In the **Model Builder** window, under **Component 1 (comp1)** right-click **Mesh 1** and choose **Build All**. The mesh should look like [Figure 3](#).

## **STUDY 1**

*Step 1: Ray Tracing*

**1** In the **Model Builder** window, under **Study 1** click **Step 1: Ray Tracing**.

- 2 In the **Settings** window for **Ray Tracing**, locate the **Study Settings** section.
- 3 From the **Time-step specification** list, choose **Specify maximum path length**.
- 4 In the **Lengths** text field, type 0.17. This path length is sufficient to ensure that all rays reach the image plane.
- 5 In the **Study** toolbar, click  **Compute**.

Now, create a ray diagram.

## RESULTS

### *Ray Diagram*

- 1 In the **Settings** window for **3D Plot Group**, type Ray Diagram in the **Label** text field.
- 2 Click to expand the **Title** section. From the **Title type** list, choose **None**.
- 3 Locate the **Color Legend** section. Select the **Show maximum and minimum values** checkbox.
- 4 Select the **Show units** checkbox.
- 5 In the **Model Builder** window, expand the **Ray Diagram** node.

### *Color Expression 1*

- 1 In the **Model Builder** window, expand the **Results > Ray Diagram > Ray Trajectories 1** node, then click **Color Expression 1**.
- 2 In the **Settings** window for **Color Expression**, locate the **Expression** section.
- 3 In the **Expression** text field, type at ('last', gop.rrel). This is the radial coordinate relative to the centroid at the image plane for each release feature.
- 4 From the **Unit** list, choose **µm**.

### *Surface 1*

- 1 In the **Model Builder** window, right-click **Ray Diagram** and choose **Surface**.
- 2 In the **Settings** window for **Surface**, locate the **Coloring and Style** section.
- 3 From the **Coloring** list, choose **Uniform**.
- 4 From the **Color** list, choose **Gray**.



### *Selection 1*

- 1 Right-click **Surface 1** and choose **Selection**.
- 2 In the **Settings** window for **Selection**, locate the **Selection** section.
- 3 From the **Selection** list, choose **Obstructions**.

### Surface 2

- 1 In the **Model Builder** window, right-click **Ray Diagram** and choose **Surface**.
- 2 In the **Settings** window for **Surface**, locate the **Coloring and Style** section.
- 3 From the **Coloring** list, choose **Uniform**.
- 4 From the **Color** list, choose **Custom**.
- 5 On Windows, click the colored bar underneath, or — if you are running the cross-platform desktop — the **Color** button.
- 6 Click **Define custom colors**.
- 7 Set the RGB values to 189, 201, and 216, respectively.
- 8 Click **Add to custom colors**.
- 9 Click **Show color palette only** or **OK** on the cross-platform desktop.

### Selection 1

- 1 Right-click **Surface 2** and choose **Selection**.
- 2 Select Boundaries 4 and 11 only.
- 3 In the **Ray Diagram** toolbar, click  **Plot**.
- 4 Click the  **Zoom Extents** button in the **Graphics** toolbar. Compare the resulting image to [Figure 4](#).

### Spot Diagram

Next, create a spot diagram.



- 1 In the **Results** toolbar, click  **2D Plot Group**.
- 2 In the **Settings** window for **2D Plot Group**, type Spot Diagram in the **Label** text field.
- 3 Locate the **Color Legend** section. Select the **Show units** checkbox.

### Spot Diagram 1

- 1 In the **Spot Diagram** toolbar, click  **More Plots** and choose **Spot Diagram**.
- 2 In the **Settings** window for **Spot Diagram**, locate the **Layout** section.
- 3 From the **Layout** list, choose **Rectangular grid**.
- 4 In the **Horizontal padding factor** text field, type 0.
- 5 Click to expand the **Annotations** section. Select the **Show circle** checkbox.
- 6 In the **Radius** text field, type  $r_{\text{Airy}}$ .

### Color Expression 1

- 1 Right-click **Spot Diagram 1** and choose **Color Expression**.

- 2 In the **Settings** window for **Color Expression**, locate the **Expression** section.
- 3 In the **Expression** text field, type at  $(0, \text{gop} . \text{rr} \text{e}1)$ . This is the radial coordinate relative to the centroid at the entrance pupil for each ray release.
- 4 In the **Spot Diagram** toolbar, click  **Plot**.
- 5 Click the  **Zoom Extents** button in the **Graphics** toolbar. Compare the resulting image to [Figure 5](#).