



Model created in COMSOL Multiphysics 6.4

# An SMA Connector on a Grounded Coplanar Waveguide

## Introduction

---

SMA connectors are popularly used on printed circuit boards (PCB) for testing. This example shows how to excite an SMA connector on a microwave substrate and how to terminate a grounded coplanar waveguide (GCPW) with  $50\ \Omega$  using a lumped port and an air-bridge.

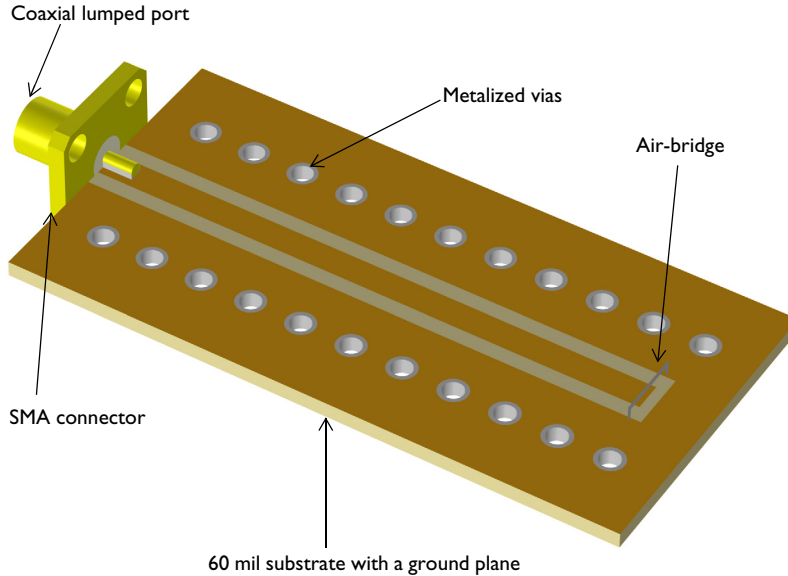

*Figure 1: An SMA connector is soldered onto a GCPW line. The other end of the GCPW line is terminated with 50 ohms using a lumped port.*

## Model Definition

---

The purpose of this example is to show how to excite a grounded coplanar waveguide with the signal from a coaxial cable through an SMA connector. The model also illustrates a particular  $50\ \Omega$  passive termination constructed with and without an air-bridge.

The signal in the coaxial cable is carried by the TEM mode at 1 GHz. Inside the cable, the electric field of the TEM mode points radially between the inner and outer conductors. (In the cross-section of the cable, the electric field is the same as the electrostatic field with a DC voltage between the conductors.) This field passes through the SMA connector and excites a symmetric mode of the coplanar waveguide. The symmetric electric field in the coplanar waveguide points from the center conductor outward to the conductors on either

side, or depending on the phase, inward from the outer conductors toward the center conductor.

The ground plane on the bottom of the PCB with  $\epsilon_r = 3.38$  is connected to the outer conductors of the CPW with metalized vias to prevent unwanted surface waves.

The domain between the inner and outer conductor of the SMA connector is filled with PTFE and all metal parts including the SMA connector, CPW, metalized vias and air-bridge are modeled as perfect electric conductors. The entire modeling domain is bounded by scattering boundaries that represent an open space except the ground plane.

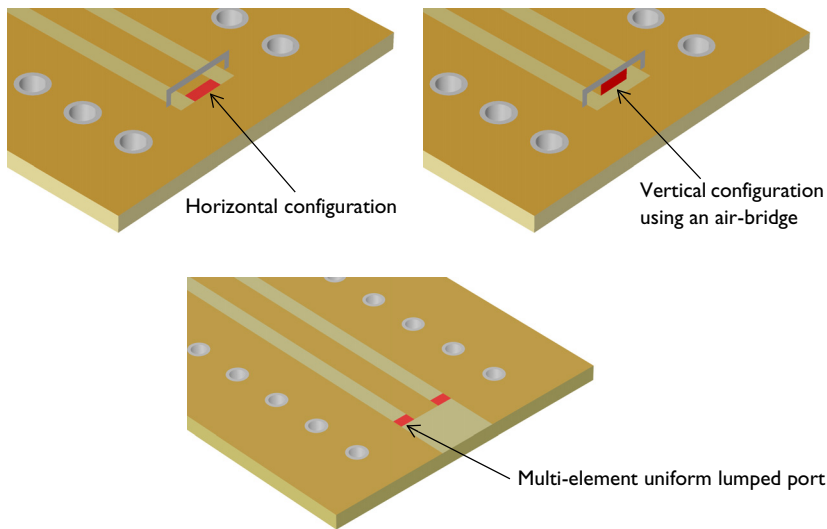

*Figure 2: Three ways to add a port on a CPW.*

This example evaluates the passive  $50 \Omega$  termination on the GCPW in three ways (Figure 2). The first approach is extending the lumped port horizontally from the center conductor to the outer conductor of the GCPW. The second approach is using an air-bridge which extends above the substrate and connects the outer conductors while maintaining an air gap between itself and the center conductor. In this case, the lumped port extends vertically from the center conductor to the air-bridge. The third approach is using a multi-element uniform lumped port that terminate/excites two slots equally.

All domains are meshed by a tetrahedral mesh with maximum element size of five elements per wavelength so that the wave is well-resolved. The parts in SMA connector and vias are meshed more finely to provide good resolution of the curved surfaces.

## Results and Discussion

The norm of electric fields is plotted in [Figure 3](#). The plot setting is modified to show the fields on  $xy$ -plane confined between the center conductor and outer conductor (ground plane) of the GCPW. The evaluated S-parameters for all passive termination methods are better than  $-20$  dB.

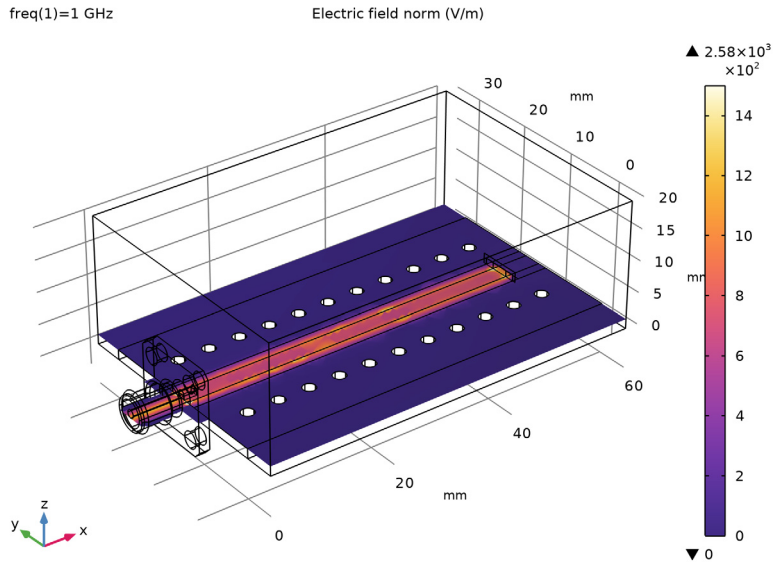

Figure 3: The plotted electric field distribution is symmetric due to the geometry setup.

---

**Application Library path:** RF\_Module/Transmission\_Lines\_and\_Waveguides/sma\_connectorized\_gcpw

---



## Modeling Instructions

From the **File** menu, choose **New**.

### NEW

In the **New** window, click  **Model Wizard**.

## MODEL WIZARD

- 1 In the **Model Wizard** window, click  **3D**.
- 2 In the **Select Physics** tree, select **Radio Frequency > Electromagnetic Waves, Frequency Domain (emw)**.
- 3 Click **Add**.
- 4 Click  **Study**.
- 5 In the **Select Study** tree, select **General Studies > Frequency Domain**.
- 6 Click  **Done**.

## GEOMETRY 1

- 1 In the **Model Builder** window, under **Component 1 (comp1)** click **Geometry 1**.
- 2 In the **Settings** window for **Geometry**, locate the **Units** section.
- 3 From the **Length unit** list, choose **mm**.

## GLOBAL DEFINITIONS



### *Parameters 1*

- 1 In the **Model Builder** window, under **Global Definitions** click **Parameters 1**.
- 2 In the **Settings** window for **Parameters**, locate the **Parameters** section.
- 3 In the table, enter the following settings:



Name	Expression	Value	Description
w_c	2.8[mm]	0.0028 m	CPW, center conductor width
w_s	5.8[mm]	0.0058 m	CPW, center conductor and slot width

## GEOMETRY 1

### *Block 1 (blk1)*

- 1 In the **Geometry** toolbar, click  **Block**.
- 2 In the **Settings** window for **Block**, locate the **Size and Shape** section.
- 3 In the **Width** text field, type 60.
- 4 In the **Depth** text field, type 40.
- 5 In the **Height** text field, type 20.
- 6 Locate the **Position** section. In the **y** text field, type -5.
- 7 Click the  **Wireframe Rendering** button in the **Graphics** toolbar.

*Block 2 (blk2)*

- 1 In the **Geometry** toolbar, click  **Block**.
- 2 In the **Settings** window for **Block**, locate the **Size and Shape** section.
- 3 In the **Width** text field, type 60.
- 4 In the **Depth** text field, type 30.
- 5 In the **Height** text field, type 1.524.
- 6 Click  **Build Selected**.

*Work Plane 1 (wp1)*

- 1 In the **Geometry** toolbar, click  **Work Plane**.
- 2 In the **Settings** window for **Work Plane**, locate the **Plane Definition** section.
- 3 From the **Plane type** list, choose **Face parallel**.
- 4 On the object **blk2**, select Boundary 4 only.

It might be easier to select the correct boundary by using the **Selection List** window. To open this window, in the **Home** toolbar click **Windows** and choose **Selection List**. (If you are running the cross-platform desktop, you find **Windows** in the main menu.)

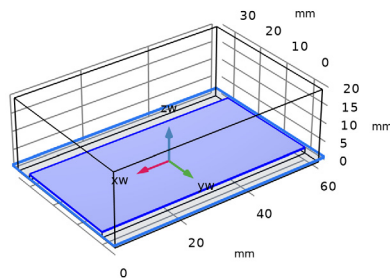

- 5 Click  **Go to Plane Geometry**.

*Work Plane 1 (wp1) > Rectangle 1 (r1)*

- 1 In the **Work Plane** toolbar, click  **Rectangle**.
- 2 In the **Settings** window for **Rectangle**, locate the **Size and Shape** section.

- 3 In the **Width** text field, type 60.
- 4 In the **Height** text field, type  $w_c$ .
- 5 Locate the **Position** section. In the **xw** text field, type -30.
- 6 In the **yw** text field, type  $-w_c/2$ .

*Work Plane 1 (wp1) > Rectangle 2 (r2)*

- 1 In the **Work Plane** toolbar, click  **Rectangle**.
- 2 In the **Settings** window for **Rectangle**, locate the **Size and Shape** section.
- 3 In the **Width** text field, type 60.
- 4 In the **Height** text field, type  $w_s$ .
- 5 Locate the **Position** section. In the **xw** text field, type -30.
- 6 In the **yw** text field, type  $-w_s/2$ .

*Work Plane 1 (wp1) > Rectangle 3 (r3)*

- 1 In the **Work Plane** toolbar, click  **Rectangle**.
- 2 In the **Settings** window for **Rectangle**, locate the **Size and Shape** section.
- 3 In the **Height** text field, type  $w_s$ .
- 4 Locate the **Position** section. In the **xw** text field, type -25.
- 5 In the **yw** text field, type  $-w_s/2$ .

## **PART LIBRARIES**

- 1 From the **Windows** menu, choose **Part Libraries**.
- 2 In the **Model Builder** window, click **Geometry 1**.
- 3 In the **Part Libraries** window, select **RF Module > Connectors > SMA Connectors > connector\_sma\_flange4** in the tree.
- 4 Click  **Add to Geometry**.

## **GEOMETRY 1**

*SMA Connector, Square Flange with Four Holes 1 (pi1)*

- 1 In the **Model Builder** window, under **Component 1 (comp1) > Geometry 1** click **SMA Connector, Square Flange with Four Holes 1 (pi1)**.
- 2 In the **Settings** window for **Part Instance**, locate the **Position and Orientation of Output** section.
- 3 Find the **Displacement** subsection. In the **ywi** text field, type 15.

4 In the **zwi** text field, type 1.524+0.635.

This is the sum of the substrate thickness and the inner radius of the imported SMA connector part.

5 Locate the **Input Parameters** section. In the table, enter the following settings:

Name	Expression	Value	Description
l_dielectric	8 [mm]	8 mm	Length of dielectric
l_pin	2 [mm]	2 mm	Length of pin from flange

6 Click to expand the **Domain Selections** section. In the table, enter the following settings:

Name	Keep	Physics	Contribute to
Dielectric	√	√	None

7 Click to expand the **Boundary Selections** section. In the table, enter the following settings:

Name	Keep	Physics	Contribute to
Conductive surface	√	√	None

8 Click  **Build Selected**.

*Cylinder 1 (cyl1)*

1 In the **Geometry** toolbar, click  **Cylinder**.

2 In the **Settings** window for **Cylinder**, locate the **Size and Shape** section.

3 In the **Height** text field, type 1.524.

4 Locate the **Position** section. In the **x** text field, type 5.

5 In the **y** text field, type 7.

*Array 1 (arr1)*

1 In the **Geometry** toolbar, click  **Transforms** and choose **Array**.

2 Select the object **cyl1** only.

3 In the **Settings** window for **Array**, locate the **Size** section.



4 In the **x size** text field, type 11.

5 In the **y size** text field, type 2.

6 Locate the **Displacement** section. In the **x** text field, type 5.



7 In the **y** text field, type 16.

### *Difference 1 (dif1)*

- 1 In the **Geometry** toolbar, click  **Booleans and Partitions** and choose **Difference**.
- 2 Select the objects **blk1** and **blk2** only.
- 3 In the **Settings** window for **Difference**, locate the **Difference** section.
- 4 Click to select the  **Activate Selection** toggle button for **Objects to subtract**.
- 5 Select the objects **arr1(1,1,1)**, **arr1(1,2,1)**, **arr1(10,1,1)**, **arr1(10,2,1)**, **arr1(11,1,1)**, **arr1(11,2,1)**, **arr1(2,1,1)**, **arr1(2,2,1)**, **arr1(3,1,1)**, **arr1(3,2,1)**, **arr1(4,1,1)**, **arr1(4,2,1)**, **arr1(5,1,1)**, **arr1(5,2,1)**, **arr1(6,1,1)**, **arr1(6,2,1)**, **arr1(7,1,1)**, **arr1(7,2,1)**, **arr1(8,1,1)**, **arr1(8,2,1)**, **arr1(9,1,1)**, and **arr1(9,2,1)** only.
- 6 Click  **Build All Objects**.

The vias are not part of the model domain. By removing from the model domain, the exterior boundaries of those vias are set to PEC by default.

### *Work Plane 2 (wp2)*

- 1 In the **Geometry** toolbar, click  **Work Plane**.
- 2 In the **Settings** window for **Work Plane**, locate the **Plane Definition** section.
- 3 From the **Plane** list, choose **zy-plane**.
- 4 In the **x-coordinate** text field, type 54.
- 5 Click  **Go to Plane Geometry**.



### *Work Plane 2 (wp2) > Rectangle 1 (r1)*

- 1 In the **Work Plane** toolbar, click  **Rectangle**.
- 2 In the **Settings** window for **Rectangle**, locate the **Size and Shape** section.
- 3 In the **Height** text field, type  $w_s$ .
- 4 Locate the **Position** section. In the **xw** text field, type 1.524.
- 5 In the **yw** text field, type 12.1.

### *Work Plane 2 (wp2) > Rectangle 2 (r2)*

- 1 In the **Work Plane** toolbar, click  **Rectangle**.
- 2 In the **Settings** window for **Rectangle**, locate the **Size and Shape** section.
- 3 In the **Width** text field, type 1.6.
- 4 In the **Height** text field, type 6.8.
- 5 Locate the **Position** section. In the **xw** text field, type 1.524.
- 6 In the **yw** text field, type 11.6.

Work Plane 2 (wp2) > Difference 1 (dif1)

- 1 In the **Work Plane** toolbar, click  **Booleans and Partitions** and choose **Difference**.
- 2 Select the object **r2** only.
- 3 In the **Settings** window for **Difference**, locate the **Difference** section.
- 4 Click to select the  **Activate Selection** toggle button for **Objects to subtract**.
- 5 Select the object **r1** only.

Work Plane 2 (wp2) > Rectangle 3 (r3)

- 1 In the **Work Plane** toolbar, click  **Rectangle**.
- 2 In the **Settings** window for **Rectangle**, locate the **Size and Shape** section.
- 3 In the **Height** text field, type 2.8.
- 4 Locate the **Position** section. In the **xw** text field, type 1.524.
- 5 In the **yw** text field, type 13.6.
- 6 In the **Model Builder** window, right-click **Geometry 1** and choose **Build All**.

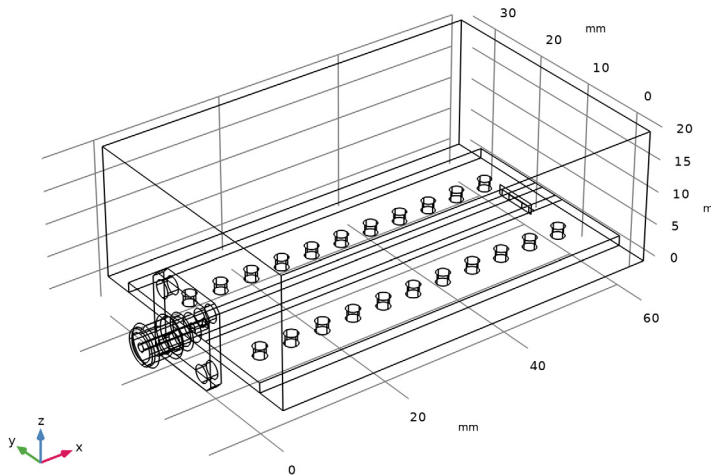

The finished geometry should look like this.



Disable the analysis of the geometry as the remaining small geometric details can be kept.

- 7 In the **Model Builder** window, click **Geometry 1**.
- 8 In the **Settings** window for **Geometry**, locate the **Cleanup** section.

- 9 Clear the **Automatic detection of small details** checkbox.

## ELECTROMAGNETIC WAVES, FREQUENCY DOMAIN (EMW)

### *Perfect Electric Conductor 2*

- 1 In the **Physics** toolbar, click  **Boundaries** and choose **Perfect Electric Conductor**.
- 2 In the **Settings** window for **Perfect Electric Conductor**, locate the **Boundary Selection** section.
- 3 Click  **Paste Selection**.
- 4 In the **Paste Selection** dialog, type 68 69 77 89 210 211 212 in the **Selection** text field.
- 5 Click **OK**.

### *Perfect Electric Conductor 3*

- 1 In the **Physics** toolbar, click  **Boundaries** and choose **Perfect Electric Conductor**.
- 2 In the **Settings** window for **Perfect Electric Conductor**, locate the **Boundary Selection** section.
- 3 From the **Selection** list, choose **Conductive surface (SMA Connector, Square Flange with Four Holes 1)**.

### *Lumped Port 1*

- 1 In the **Physics** toolbar, click  **Boundaries** and choose **Lumped Port**.
- 2 Select Boundary 4 only.
- 3 In the **Settings** window for **Lumped Port**, locate the **Lumped Port Properties** section.
- 4 From the **Type of lumped port** list, choose **Coaxial**.  
For the first port, wave excitation is **on** by default.

### *Lumped Port 2*

- 1 In the **Physics** toolbar, click  **Boundaries** and choose **Lumped Port**.
- 2 Select Boundary 203 only.

### *Scattering Boundary Condition 1*

- 1 In the **Physics** toolbar, click  **Boundaries** and choose **Scattering Boundary Condition**.
- 2 Select Boundaries 62–66, 73, 90, 91, 93, 94, 215, and 216 only.

## MATERIALS

### *Material 1 (mat1)*

- 1 In the **Model Builder** window, under **Component 1 (comp1)** right-click **Materials** and choose **Blank Material**.

2 In the **Settings** window for **Material**, locate the **Material Contents** section.

3 In the table, enter the following settings:

Property	Variable	Value	Unit	Property group
Relative permittivity	epsilon <sub>r_iso</sub> ; epsilon <sub>r_ii</sub> = epsilon <sub>r_iso</sub> , epsilon <sub>r_ij</sub> = 0	1		Basic
Relative permeability	mu <sub>r_iso</sub> ; mu <sub>r_ii</sub> = mu <sub>r_iso</sub> , mu <sub>r_ij</sub> = 0	1		Basic
Electric conductivity	sigma <sub>iso</sub> ; sigma <sub>ii</sub> = sigma <sub>iso</sub> , sigma <sub>ij</sub> = 0	0	S/m	Basic

#### Material 2 (mat2)

1 Right-click **Materials** and choose **Blank Material**.

2 In the **Settings** window for **Material**, locate the **Geometric Entity Selection** section.

3 From the **Selection** list, choose **Dielectric (SMA Connector, Square Flange with Four Holes 1)**.

4 Locate the **Material Contents** section. In the table, enter the following settings:

Property	Variable	Value	Unit	Property group
Relative permittivity	epsilon <sub>r_iso</sub> ; epsilon <sub>r_ii</sub> = epsilon <sub>r_iso</sub> , epsilon <sub>r_ij</sub> = 0	2.1		Basic
Relative permeability	mu <sub>r_iso</sub> ; mu <sub>r_ii</sub> = mu <sub>r_iso</sub> , mu <sub>r_ij</sub> = 0	1		Basic
Electric conductivity	sigma <sub>iso</sub> ; sigma <sub>ii</sub> = sigma <sub>iso</sub> , sigma <sub>ij</sub> = 0	0	S/m	Basic

#### Material 3 (mat3)

1 Right-click **Materials** and choose **Blank Material**.

- 2 Select Domain 6 only.
- 3 In the **Settings** window for **Material**, locate the **Material Contents** section.
- 4 In the table, enter the following settings:

Property	Variable	Value	Unit	Property group
Relative permittivity	epsilon <sub>r_iso</sub> ; epsilon <sub>r_ii</sub> = epsilon <sub>r_iso</sub> , epsilon <sub>r_ij</sub> = 0	3.38		Basic
Relative permeability	mu <sub>r_iso</sub> ; mu <sub>r_ii</sub> = mu <sub>r_iso</sub> , mu <sub>r_ij</sub> = 0	1		Basic
Electric conductivity	sigma <sub>iso</sub> ; sigma <sub>ii</sub> = sigma <sub>iso</sub> , sigma <sub>ij</sub> = 0	0	S/m	Basic

#### MESH 1

- 1 In the **Model Builder** window, under **Component 1 (comp1)** click **Mesh 1**.
- 2 In the **Settings** window for **Mesh**, locate the **Physics-Controlled Mesh** section.
- 3 From the **Element size** list, choose **Coarser**.
- 4 Click  **Build All**.

#### DEFINITIONS

##### *Hide for Physics 1*

- 1 In the **Model Builder** window, expand the **Component 1 (comp1) > Definitions** node.
- 2 Right-click **View 1** and choose **Hide for Physics**.
- 3 In the **Settings** window for **Hide for Physics**, locate the **Geometric Entity Selection** section.
- 4 From the **Geometric entity level** list, choose **Boundary**.
- 5 Select Boundaries 62, 63, 65, 94, and 215 only.

## MESH 1

In the **Model Builder** window, under **Component 1 (comp1)** click **Mesh 1**.

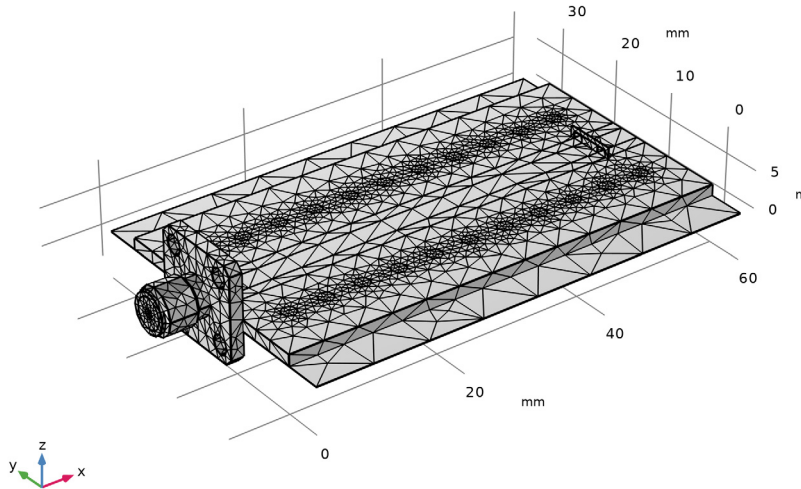

## STUDY 1

In the **Study** toolbar, click  **Compute**.

## RESULTS

### *Multislice 1*

- 1 In the **Model Builder** window, expand the **Results > Electric Field (emw)** node, then click **Multislice 1**.
- 2 In the **Settings** window for **Multislice**, locate the **Multipane Data** section.
- 3 Find the **X-planes** subsection. In the **Planes** text field, type 0.
- 4 Find the **Y-planes** subsection. In the **Planes** text field, type 0.
- 5 Find the **Z-planes** subsection. From the **Entry method** list, choose **Coordinates**.
- 6 In the **Coordinates** text field, type 1.5.
- 7 Click to expand the **Range** section. Select the **Manual color range** checkbox.
- 8 In the **Maximum** text field, type 1500.
- 9 Locate the **Coloring and Style** section. From the **Color table** list, choose **HeatCameraLight**.

10 In the **Electric Field (emw)** toolbar, click  **Plot**.

*Electric Field, Logarithmic (emw)*

In the **Model Builder** window, under **Results** click **Electric Field, Logarithmic (emw)**.

freq(1)=1 GHz Surface: 1 (1) Surface: 1 (1) Surface: Electric field norm (V/m) Surface: Electric field norm (V/m)

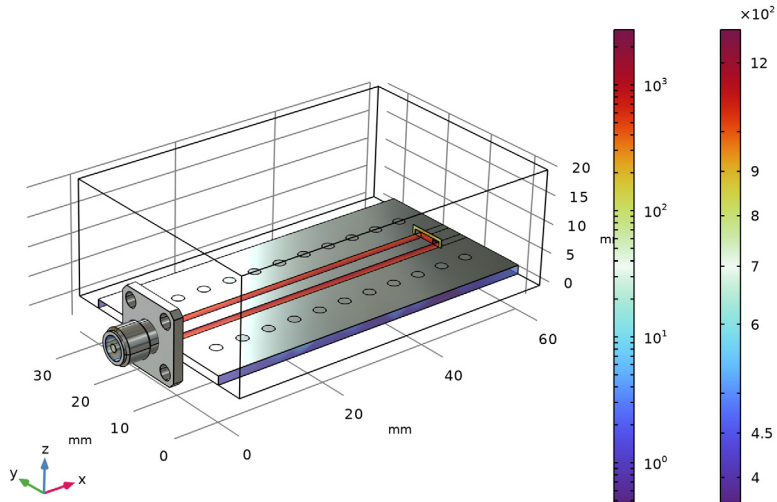

*S-Parameter (emw)*

Add the PEC air-bridge and place the listener port between the CPW center conductor and air-bridge. Then, compute again.

## ELECTROMAGNETIC WAVES, FREQUENCY DOMAIN (EMW)

*Perfect Electric Conductor 4*

- 1 In the **Model Builder** window, expand the **Results > S-Parameter (emw)** node.
- 2 Right-click **Component 1 (comp1) > Electromagnetic Waves, Frequency Domain (emw)** and choose the boundary condition **Perfect Electric Conductor**.
- 3 Select Boundary 200 only.

*Lumped Port 2*

- 1 In the **Model Builder** window, click **Lumped Port 2**.
- 2 In the **Settings** window for **Lumped Port**, locate the **Boundary Selection** section.
- 3 Click  **Clear Selection**.

4 Select Boundary 202 only.

### STUDY 1

In the **Study** toolbar, click  **Compute**.

### RESULTS

#### *Multislice 1*

In the **Model Builder** window, under **Results** > **Electric Field (emw)** click **Multislice 1**.

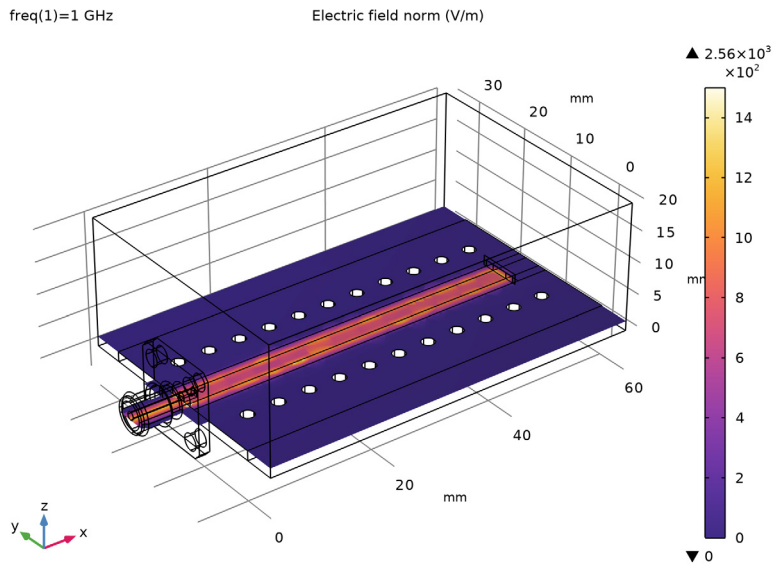

## ELECTROMAGNETIC WAVES, FREQUENCY DOMAIN (EMW)

#### *Perfect Electric Conductor 2*

1 In the **Model Builder** window, expand the **Results** > **S-Parameter (emw)** node, then click **Component 1 (comp1)** > **Electromagnetic Waves, Frequency Domain (emw)** > **Perfect Electric Conductor 2**.

2 Select Boundaries 68, 69, 77, 89, and 203 only.

#### *Lumped Port 2*

1 In the **Model Builder** window, click **Lumped Port 2**.

2 In the **Settings** window for **Lumped Port**, locate the **Boundary Selection** section.

- 3 Click  **Clear Selection**.
- 4 Select Boundaries 201 and 204 only.
- 5 Locate the **Lumped Port Properties** section. From the **Type of lumped port** list, choose **Multielement uniform**.

*Uniform Element 1*

- 1 In the **Model Builder** window, click **Uniform Element 1**.
- 2 In the **Settings** window for **Uniform Element**, locate the **Boundary Selection** section.
- 3 Click  **Clear Selection**.
- 4 Select Boundary 204 only.
- 5 Locate the **Uniform Element Properties** section. Specify the  $\mathbf{a}_h$  vector as

0	x
1	y
0	z

*Uniform Element 2*

- 1 In the **Model Builder** window, click **Uniform Element 2**.
- 2 Select Boundary 201 only.
- 3 In the **Settings** window for **Uniform Element**, locate the **Uniform Element Properties** section.
- 4 Specify the  $\mathbf{a}_h$  vector as

0	x
-1	y
0	z

*Perfect Electric Conductor 4*

- 1 In the **Model Builder** window, under **Component 1 (comp1) > Electromagnetic Waves, Frequency Domain (emw)** right-click **Perfect Electric Conductor 4** and choose **Disable**.
- 2 In the **Home** toolbar, click  **Compute**.

**RESULTS**

*S-Parameter (emw)*

- 1 In the **Model Builder** window, under **Results > S-Parameter (emw)** click **S-Parameter (emw)**.

2 In the **S-Parameter (emw)** toolbar, click  **Evaluate**.

#### *Multislice 1*

1 In the **Model Builder** window, under **Results** > **Electric Field (emw)** click **Multislice 1**.

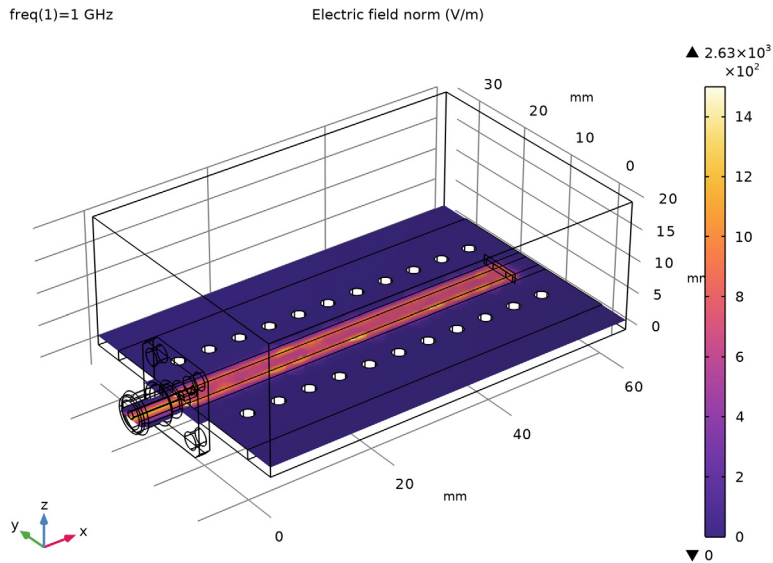

2 Right-click **Results** > **Electric Field (emw)** > **Multislice 1** and choose **Disable**.

#### *Surface 1*

In the **Model Builder** window, right-click **Electric Field (emw)** and choose **Surface**.

#### *Selection 1*

1 In the **Model Builder** window, right-click **Surface 1** and choose **Selection**.

2 In the **Settings** window for **Selection**, locate the **Selection** section.

3 From the **Selection** list, choose **Conductive surface (SMA Connector, Square Flange with Four Holes 1)**.

#### *Surface 1*

1 In the **Model Builder** window, click **Surface 1**.

2 In the **Settings** window for **Surface**, locate the **Coloring and Style** section.

3 From the **Color table** list, choose **AuroraAustralis**.

4 Clear the **Color legend** checkbox.

### Electric Field (emw)

- 1 In the **Model Builder** window, click **Electric Field (emw)**.
- 2 In the **Settings** window for **3D Plot Group**, locate the **Plot Settings** section.
- 3 Clear the **Plot dataset edges** checkbox.

### Volume 1

- 1 Right-click **Electric Field (emw)** and choose **Volume**.
- 2 In the **Settings** window for **Volume**, locate the **Coloring and Style** section.
- 3 From the **Color table** list, choose **AuroraBorealis**.

### Selection 1

- 1 Right-click **Volume 1** and choose **Selection**.
- 2 Select Domain 6 only.
- 3 In the **Electric Field (emw)** toolbar, click  **Plot**.

freq(1)=1 GHz

Surface: Electric field norm (V/m) Volume: Electric field norm (V/m)

