



Model created in COMSOL Multiphysics 6.4

Microstrip Patch Antenna

Introduction

The microstrip patch antenna is used in a wide range of applications because it is easy to design and fabricate. The antenna is attractive due to its low-profile conformal design, relatively low cost, and very narrow bandwidth. This example uses an inset feeding strategy that does not need any additional matching parts.

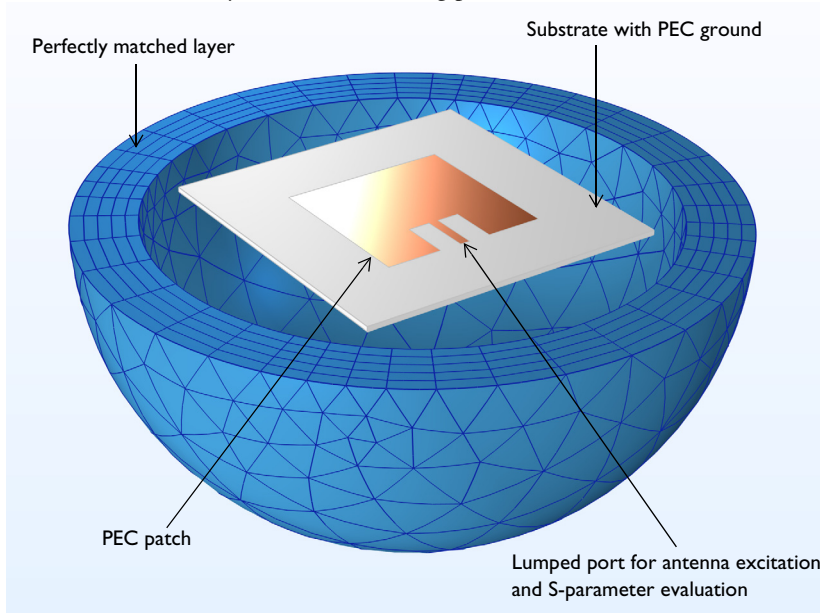

Figure 1: Microstrip patch antenna. The model consists of a PEC ground plane, a $50\ \Omega$ microstrip line fed by a lumped port, a region of free space, and a perfectly matched layer (PML) domain.

Model Definition

Feeding a patch antenna from the edge leads to a very high input impedance, causing an undesirable impedance mismatch if a conventional $50\ \Omega$ line is directly connected. One solution to this problem is to use a matching network of quarter-wave transformers between the feed point of the $50\ \Omega$ line and the patch. However, this approach has two drawbacks. First, the quarter-wave transformers would be realized as microstrip lines that would have to extend beyond the patch antenna, significantly increasing the overall structure size. Second, these microstrip lines should have a high characteristic impedance and thus would have to be narrower than a possible width for fabrication. Therefore, a better approach is desired.

This example uses a different feed point for the patch antenna to improve matching between the $50\ \Omega$ feed and the antenna. It is known that the antenna impedance is higher than $50\ \Omega$ if fed from the edge, and lower if fed from the center. Therefore, an optimum feed point exists between the center and the edge. The matching strategy is shown in [Figure 2](#). A $50\ \Omega$ microstrip line, fed from the end, extends into the patch antenna structure. The width of the cutout region, W , is chosen to be large enough so that there is minimal coupling between the antenna and the microstrip, but not so large as to significantly affect the antenna characteristics. The length of the microstrip line, L , is chosen to minimize the reflected power, S_{11} . These optimal dimensions can be found via a parametric sweep; this example only treats the final design.

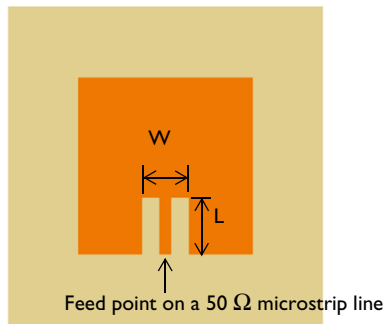

Figure 2: The matching strategy between a $50\ \Omega$ line and a patch antenna. A microstrip line of length L extends into a slot of width W cut into the patch antenna.

Results and Discussion

The norm of the electric field inside the antenna substrate is described in [Figure 3](#) where an arrow plot of the electric field is included. The direction of the arrows indicate the dominant polarization in the direction of maximum radiation — the antenna boresight. [Figure 4](#) shows the radiation pattern in the E-plane and H-plane. The E-plane is defined by the direction of the dominant antenna polarization and the H-plane is the plane the magnetic field is mainly polarized in. The 3D far-field radiation pattern is visualized in [Figure 5](#) showing the directive beam pattern due to the ground plane that blocks the radiation toward the bottom side. The calculated antenna directivity is greater than 6.9 dB. With the choice of feed point used in this example, the S_{11} parameter is better than -10 dB, and the front-to-back ratio in the radiation pattern is more than 15 dB. The frequency response evaluated with 100 kHz resolution is plotted in [Figure 7](#). The -10 dB S_{11} bandwidth is wider than 10 MHz.

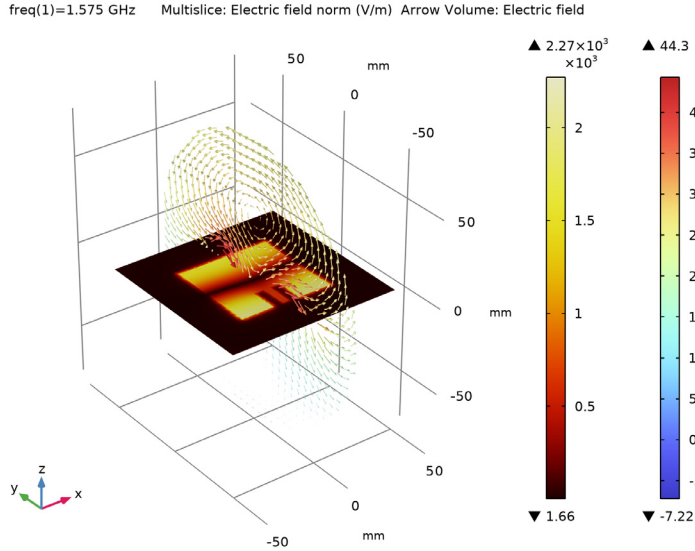

Figure 3: The norm of the electric field is stronger along the radiation edges. The arrow plot shows the dominant direction of polarization of the electric field at the antenna boresight.

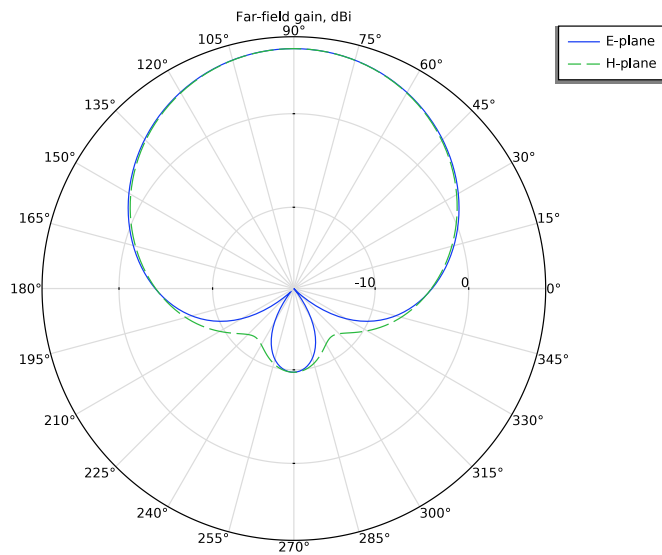

Figure 4: Far-field radiation pattern (gain in dBi) at E-plane and H-plane. Because of the bottom ground plane, the radiation pattern is directed toward the top.

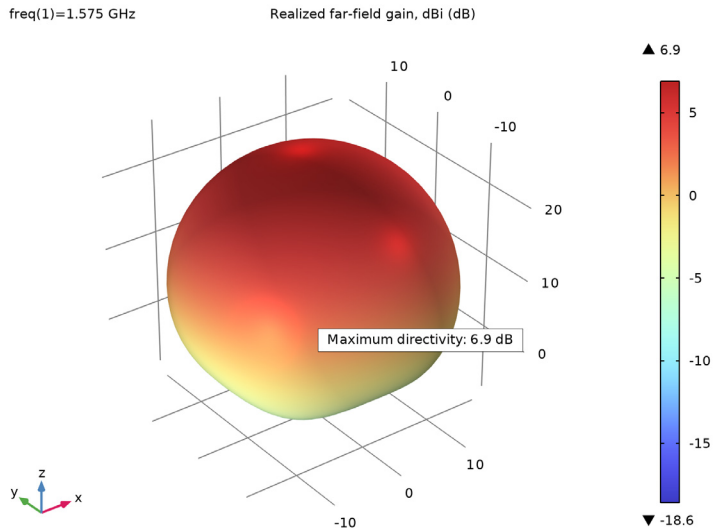

Figure 5: The 3D far-field radiation pattern is directed toward the top. The directivity can be evaluated when plotting the 3D far-field pattern.

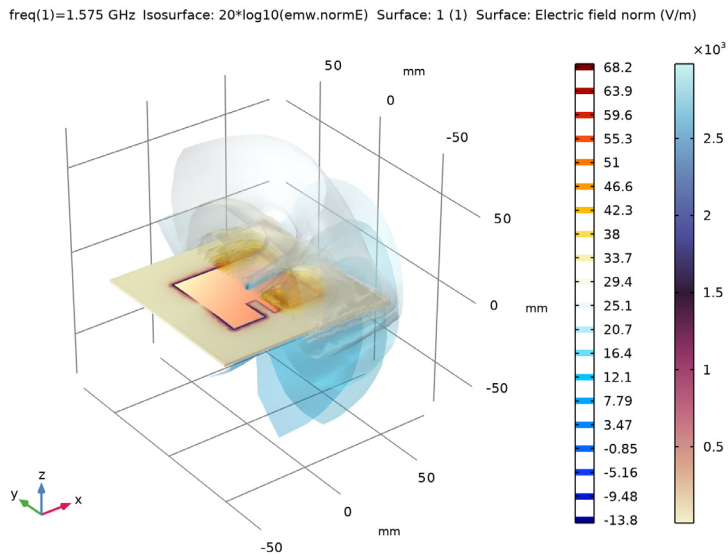

Figure 6: An isosurface plot visualizes the decay of the field amplitude.

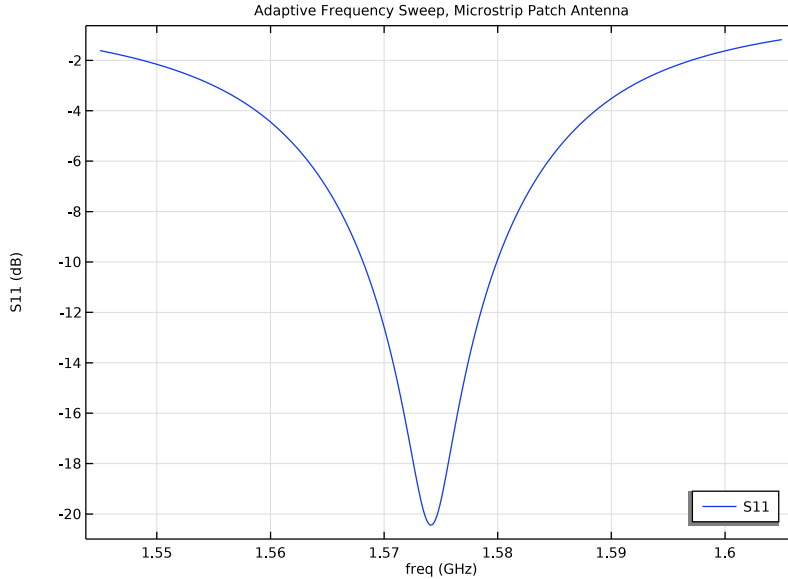

Figure 7: This S -parameter (S_{11}) plot shows that the antenna impedance is matched to 50Ω around 1.575 GHz.

The 3D full-wave simulation for an antenna array is memory intensive. By using an asymptotic approach such as multiplying the far-field of a single antenna with a uniform array factor, the radiation pattern of an antenna array can be evaluated quickly. Note that this method does not include the coupling among array elements. The 3D uniform array factor function is available under **Definitions>Functions** from the postprocessing context menu when a Far-Field Calculation feature is defined in the physics interface:

```
af3(nx, ny, nz, dx, dy, dz, alphax, alphay, alphaz)
```

where n_x , n_y , and n_z are the number of elements along the x -, y -, and z -axis, respectively. The arguments dx , dy , and dz are the distances between array elements in terms of wavelength. $alphax$, $alphay$, and $alphaz$ are the phase progressions in radians. The gain evaluation of a virtual 8-by-8 antenna array in dB scale (Figure 8) uses the following expression:

```
emw.gaindBefar+20*log10(emw.af3(8,8,1,0.48,0.48,0,0,0,0))+10*log10(1/64)
```

Since it is dB scale, the multiplication of the array factor represents a summation in the expression.

TABLE 1: INPUT ARGUMENTS OF ARRAY FACTOR OPERATOR FOR AN 8-BY-8 ARRAY.

PARAMETER	DESCRIPTION	ARGUMENT	UNIT
nx	Number of elements along x-axis	8	Dimensionless
ny	Number of elements along y-axis	8	Dimensionless
nz	Number of elements along z-axis	1	Dimensionless
dx	Distance between array elements along x-axis	0.48	Wavelength
dy	Distance between array elements along y-axis	0.48	Wavelength
dz	Distance between array elements along z-axis	0	Wavelength
alphax	Phase progression along x-axis	0	Radian
alphay	Phase progression along y-axis	0	Radian
alphaz	Phase progression along z-axis	0	Radian

This expression arises from the pattern multiplication using the array factor, such as the single antenna's r_{GainEfar} multiplied by the array factor af_3 . Therefore, the realized gain of the virtual 8-by-8 antenna array is $emw.r_{\text{GainEfar}}$ multiplied by $(af_3)^2/64$. Here, $(af_3)^2$ accounts for the pattern multiplication affecting radiation intensity, and 64 adjusts the single antenna's input power proportional to the number of array elements when all 64 elements are excited simultaneously. The logarithmic form of this expression corresponds to $emw.r_{\text{GainEfar}} + 20 \cdot \log_{10}(emw.af_3(8, 8, 1, 0.48, 0.48, 0, 0, 0, 0)) + 10 \cdot \log_{10}(1/64)$.

The direction of the main beam can be steered by defining nonzero phase progression in the uniform array factor. The maximum radiation direction of the array factor along the x -axis is defined by the angle θ from the x -axis in the phase progression using

$$\alpha_x = -kd \cos \theta = -(2\pi d/\lambda) \cos \theta$$

Figure 9 demonstrates the use of the antenna array factor. It includes three plots to show the evolution of the antenna radiation pattern from a single antenna to a synthesized antenna array via the uniform array factor:

- 1 The gain of the single microstrip patch antenna.
- 2 The radiation pattern of the uniform array factor configured to have the maximum radiation at 60 degrees from the x -axis by setting the value of `alphax` as in Table 2.

3 The gain of the 8-by-8 microstrip patch antenna array, using the array factor defined above.

TABLE 2: INPUT ARGUMENTS OF ARRAY FACTOR OPERATOR TO STEER THE BEAM.

ARGUMENT	VALUE	UNIT
alphax	$-2*\pi*0.48*\cos(\pi/3)$	Radian

The evaluation of the array factor can be simplified by using an array dataset without typing a lengthy expression. The usage of the array factor dataset is explained in the step-by-step instructions.

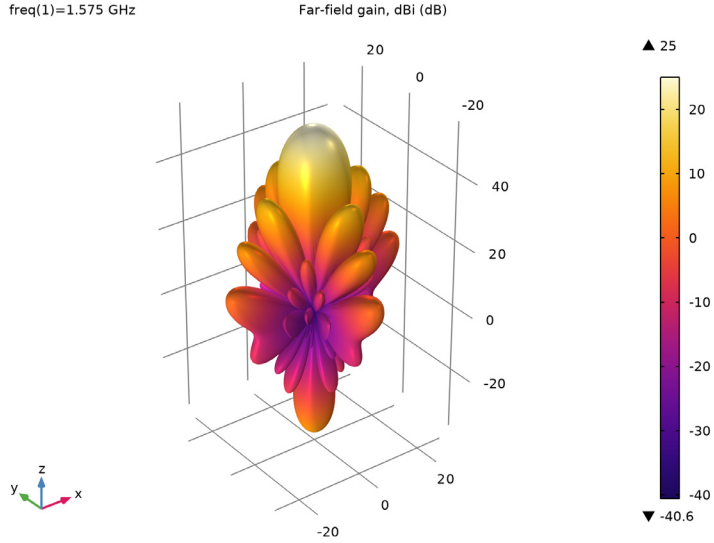

Figure 8: The far-field radiation pattern of a virtual 8-by-8 microstrip patch antenna array.

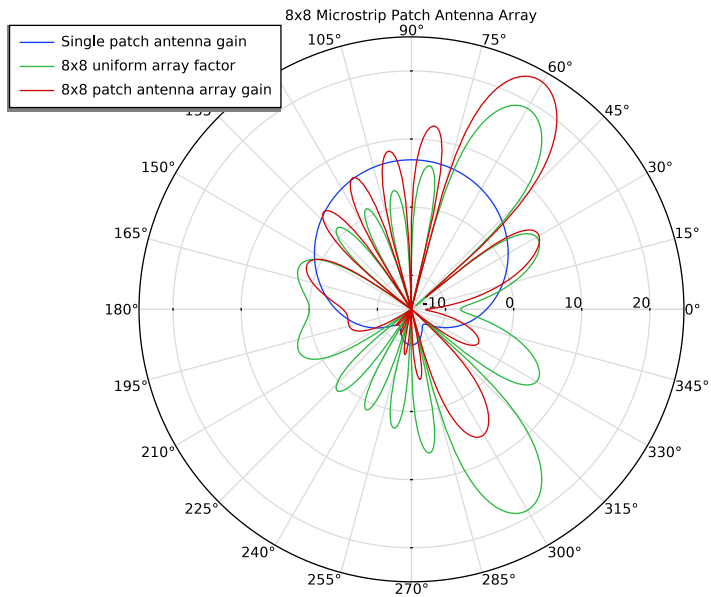

Figure 9: The single patch antenna gain, 8-by-8 uniform array factor, 8-by-8 microstrip patch antenna array gain plotted in dB scale.

Notes About the COMSOL Implementation

This example uses the Adaptive Frequency Sweep study step, based on a model order reduction technique, asymptotic waveform evaluation (AWE), to compute the frequency response of the antenna with a fine frequency resolution. This approach is faster than a regular frequency sweep performed in a Frequency Domain study using the same fine frequency resolution, but the analysis is computationally intensive, and it may require more than 5 GB of RAM when running the Adaptive Frequency Sweep. The computed results could be sensitive to the relative tolerance value in the settings window. To enhance the accuracy, a finer value can be applied.

Application Library path: RF_Module/Antenna_Arrays/
microstrip_patch_antenna_inset



Modeling Instructions

From the **File** menu, choose **New**.

NEW

In the **New** window, click  **Model Wizard**.

MODEL WIZARD

- 1 In the **Model Wizard** window, click  **3D**.
- 2 In the **Select Physics** tree, select **Radio Frequency > Electromagnetic Waves, Frequency Domain (emw)**.
- 3 Click **Add**.
- 4 Click  **Study**.
- 5 In the **Select Study** tree, select **General Studies > Frequency Domain**.
- 6 Click  **Done**.

STUDY I

Step 1: Frequency Domain

Define the study frequency ahead of performing any frequency-dependent operation such as building mesh. The physics-controlled mesh uses the specified frequency value.

- 1 In the **Model Builder** window, under **Study I** click **Step 1: Frequency Domain**.

- 2 In the **Settings** window for **Frequency Domain**, locate the **Study Settings** section.
- 3 In the **Frequencies** text field, type 1.575[GHz].

GLOBAL DEFINITIONS

Parameters 1

- 1 In the **Model Builder** window, under **Global Definitions** click **Parameters 1**.
- 2 In the **Settings** window for **Parameters**, locate the **Parameters** section.
- 3 In the table, enter the following settings:

Name	Expression	Value	Description
d	60[mil]	0.001524 m	Substrate thickness
w_line	3.2[mm]	0.0032 m	50 ohm line width
w_patch	53[mm]	0.053 m	Patch width
l_patch	52[mm]	0.052 m	Patch length
w_stub	7[mm]	0.007 m	Tuning stub width
l_stub	15.5[mm]	0.0155 m	Tuning stub length
w_sub	100[mm]	0.1 m	Substrate width
l_sub	100[mm]	0.1 m	Substrate length
freq_min	1.545[GHz]	1.545E9 Hz	Minimum frequency
freq_max	1.605[GHz]	1.605E9 Hz	Maximum frequency
lda_min	c_const/freq_max	0.18679 m	Minimum wavelength

Here mil refers to the unit milliinch, that is 1 mil = 0.0254 mm.

GEOMETRY 1

- 1 In the **Model Builder** window, under **Component 1 (comp1)** click **Geometry 1**.
- 2 In the **Settings** window for **Geometry**, locate the **Units** section.
- 3 From the **Length unit** list, choose **mm**.

First, create the substrate block.



Substrate

- 1 In the **Geometry** toolbar, click  **Block**.
- 2 In the **Settings** window for **Block**, type Substrate in the **Label** text field.
- 3 Locate the **Size and Shape** section. In the **Width** text field, type w_sub.
- 4 In the **Depth** text field, type l_sub.

- 5 In the **Height** text field, type d .
- 6 Locate the **Position** section. From the **Base** list, choose **Center**.
- 7 Click  **Build Selected**.



Now add the patch antenna.

Patch



- 1 In the **Geometry** toolbar, click  **Block**.
- 2 In the **Settings** window for **Block**, type Patch in the **Label** text field.
- 3 Locate the **Size and Shape** section. In the **Width** text field, type w_{patch} .
- 4 In the **Depth** text field, type l_{patch} .
- 5 In the **Height** text field, type d .
- 6 Locate the **Position** section. From the **Base** list, choose **Center**.
- 7 Click  **Build Selected**.

Create impedance matching parts and a 50Ω feed line.

Stub



- 1 In the **Geometry** toolbar, click  **Block**.
- 2 In the **Settings** window for **Block**, type Stub in the **Label** text field.
- 3 Locate the **Size and Shape** section. In the **Width** text field, type w_{stub} .
- 4 In the **Depth** text field, type l_{stub} .
- 5 In the **Height** text field, type d .
- 6 Locate the **Position** section. From the **Base** list, choose **Center**.
- 7 In the **x** text field, type $w_{\text{stub}}/2 + w_{\text{line}}/2$.
- 8 In the **y** text field, type $l_{\text{stub}}/2 - l_{\text{patch}}/2$.
- 9 Click  **Build Selected**.

Copy 1 (copy1)

- 1 In the **Geometry** toolbar, click  **Transforms** and choose **Copy**.
- 2 Select the object **blk3** only.
- 3 In the **Settings** window for **Copy**, locate the **Displacement** section.
- 4 In the **x** text field, type $-w_{\text{stub}} - w_{\text{line}}$.
- 5 Click  **Build Selected**.

Difference 1 (dif1)



- 1 In the **Geometry** toolbar, click  **Booleans and Partitions** and choose **Difference**.

- 2 Select the object **blk2** only.
 - 3 In the **Settings** window for **Difference**, locate the **Difference** section.
 - 4 Click to select the  **Activate Selection** toggle button for **Objects to subtract**.
 - 5 Select the objects **blk3** and **copy1** only.
 - 6 Click  **Build Selected**.
Choose wireframe rendering to get a better view of the interior parts.
 - 7 Click the  **Wireframe Rendering** button in the **Graphics** toolbar.
- Continue with the surrounding air and the PML regions.

Sphere 1 (sph1)

- 1 In the **Geometry** toolbar, click  **Sphere**.
- 2 In the **Settings** window for **Sphere**, locate the **Size** section.
- 3 In the **Radius** text field, type **1_sub**.
- 4 Click to expand the **Layers** section. In the table, enter the following settings:

Layer name	Thickness (mm)
Layer 1	1_sub/5

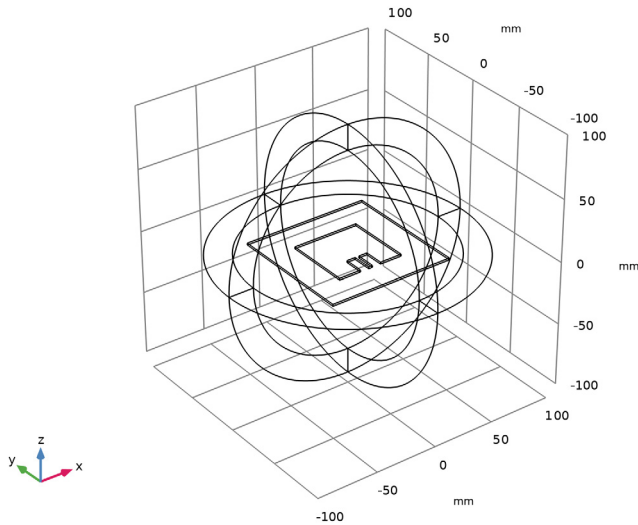

- 5 Click  **Build All Objects**.
- 6 Click the  **Zoom Extents** button in the **Graphics** toolbar.



DEFINITIONS

Now, add some selections that later will be used when defining selections for materials, physics features, and plots.

Lumped Port

- 1 In the **Definitions** toolbar, click  **Explicit**.
- 2 In the **Settings** window for **Explicit**, type Lumped Port in the **Label** text field.
- 3 Locate the **Input Entities** section. From the **Geometric entity level** list, choose **Boundary**.
- 4 Click  **Paste Selection**.
- 5 In the **Paste Selection** dialog, type 26 in the **Selection** text field.
- 6 Click **OK**.

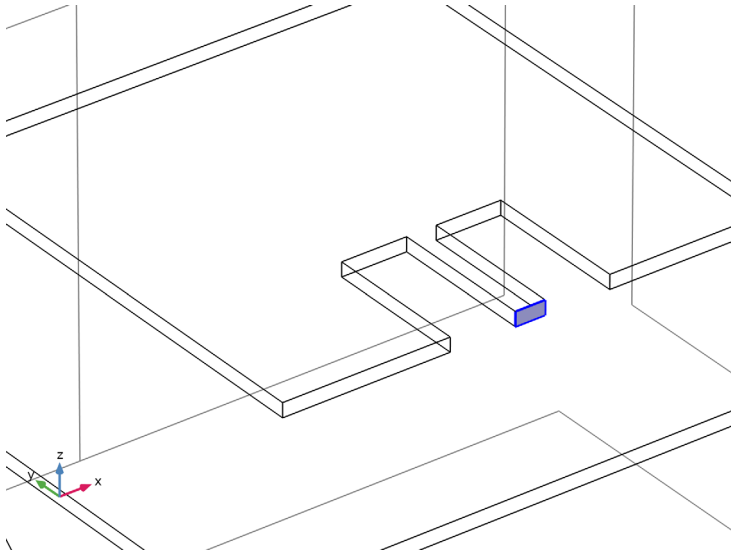

Substrate

- 1 In the **Definitions** toolbar, click  **Explicit**.
- 2 In the **Settings** window for **Explicit**, type Substrate in the **Label** text field.

3 Select Domains 6 and 7 only.

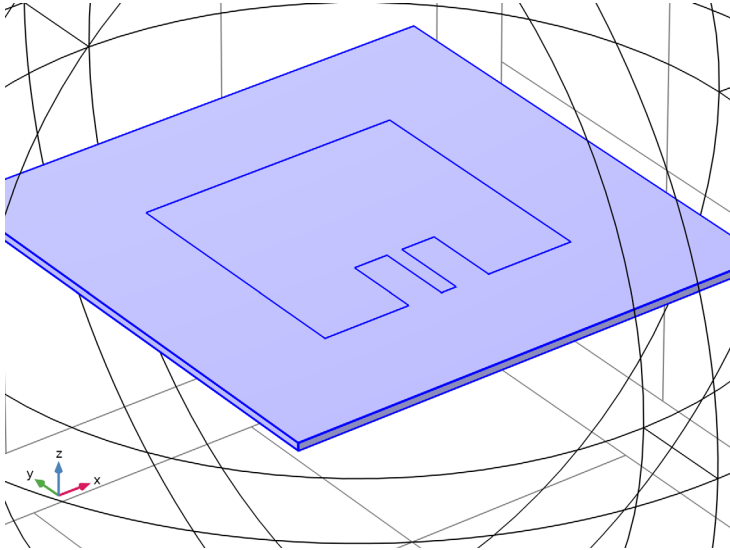

PML

- 1** In the **Definitions** toolbar, click  **Explicit**.
- 2** In the **Settings** window for **Explicit**, type PML in the **Label** text field.

3 Select Domains 1–4 and 8–11 only.

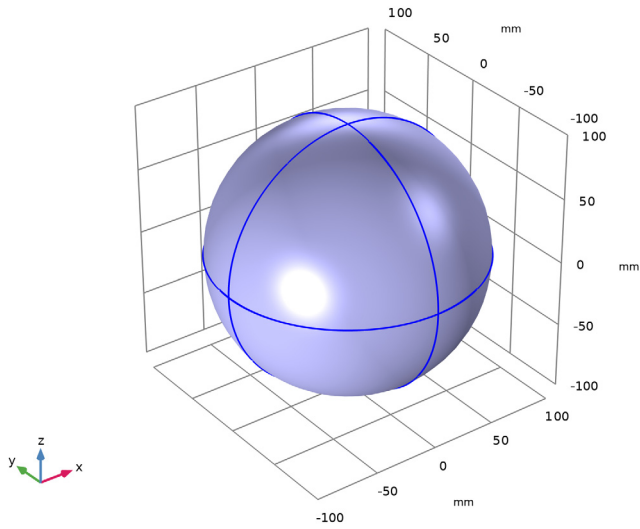

These are all of the outermost domains of the sphere.



Air

- 1 In the **Definitions** toolbar, click  **Explicit**.
- 2 In the **Settings** window for **Explicit**, type **Air** in the **Label** text field.

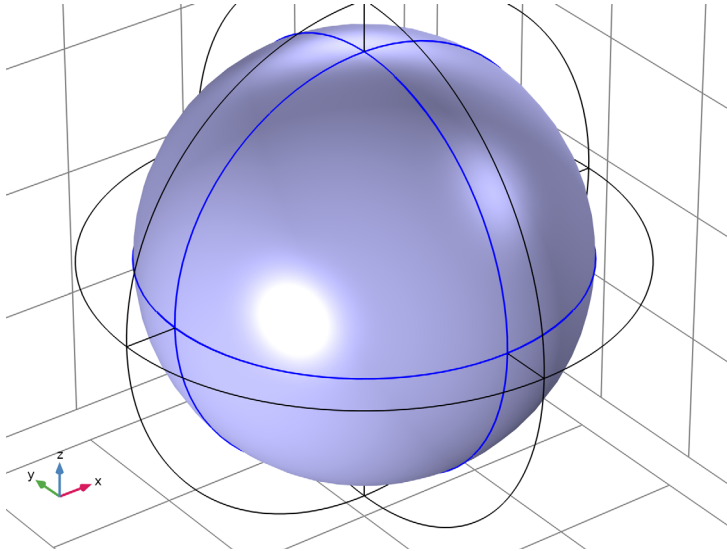

3 Select Domain 5 only.



PML, Exterior Boundaries

- 1 In the **Definitions** toolbar, click  **Adjacent**.
- 2 In the **Settings** window for **Adjacent**, type PML, Exterior Boundaries in the **Label** text field.
- 3 Locate the **Input Entities** section. Under **Input selections**, click  **Add**.
- 4 In the **Add** dialog, select **PML** in the **Input selections** list.
- 5 Click **OK**.

Air, Exterior Boundaries

- 1 In the **Definitions** toolbar, click  **Adjacent**.
- 2 In the **Settings** window for **Adjacent**, type Air, Exterior Boundaries in the **Label** text field.
- 3 Locate the **Input Entities** section. Under **Input selections**, click  **Add**.
- 4 In the **Add** dialog, select **Air** in the **Input selections** list.
- 5 Click **OK**.

PML, Inside Boundaries

- 1 In the **Definitions** toolbar, click  **Intersection**.
- 2 In the **Settings** window for **Intersection**, type PML, Inside Boundaries in the **Label** text field.

- 3 Locate the **Geometric Entity Level** section. From the **Level** list, choose **Boundary**.
- 4 Locate the **Input Entities** section. Under **Selections to intersect**, click **+ Add**.
- 5 In the **Add** dialog, in the **Selections to intersect** list, choose **PML, Exterior Boundaries** and **Air, Exterior Boundaries**.
- 6 Click **OK**.

Substrate Boundaries

- 1 In the **Definitions** toolbar, click  **Adjacent**.
- 2 In the **Settings** window for **Adjacent**, type Substrate Boundaries in the **Label** text field.
- 3 Locate the **Input Entities** section. Under **Input selections**, click **+ Add**.
- 4 In the **Add** dialog, select **Substrate** in the **Input selections** list.
- 5 Click **OK**.

Perfectly Matched Layer 1 (pml1)

- 1 In the **Definitions** toolbar, click  **Perfectly Matched Layer**.
- 2 In the **Settings** window for **Perfectly Matched Layer**, locate the **Domain Selection** section.
- 3 From the **Selection** list, choose **PML**.

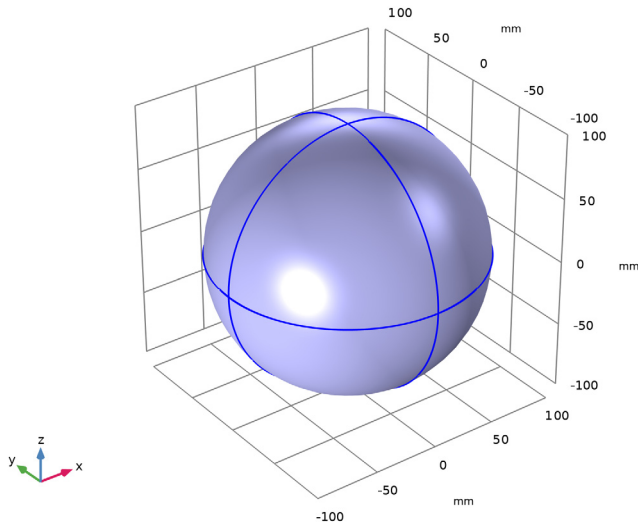

- 4 Locate the **Geometry** section. From the **Type** list, choose **Spherical**.

View 1

Suppress some domains and boundaries. This helps to see the interior parts when setting up the physics and reviewing the mesh.

Hide for Physics 1

- 1 In the **Model Builder** window, right-click **View 1** and choose **Hide for Physics**.
- 2 Select Domains 2 and 9 only.

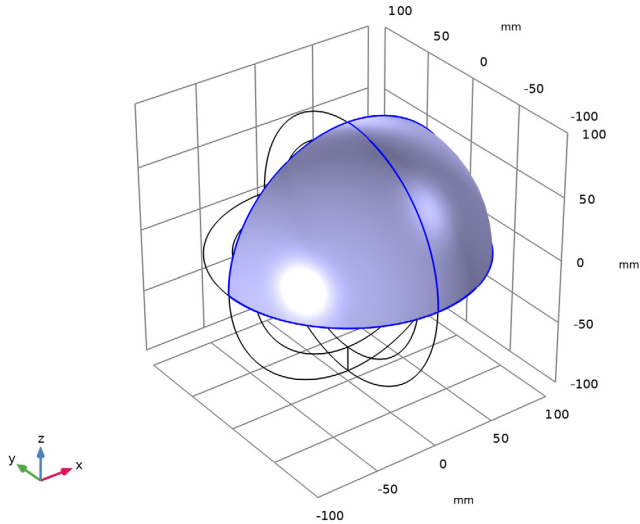

Hide for Physics 2

- 1 Right-click **View 1** and choose **Hide for Physics**.
- 2 In the **Settings** window for **Hide for Physics**, locate the **Geometric Entity Selection** section.
- 3 From the **Geometric entity level** list, choose **Boundary**.

4 Select Boundaries 10 and 33 only.

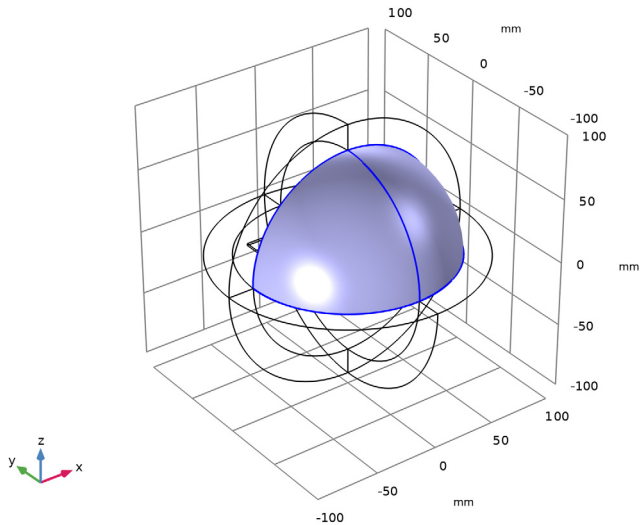

Hidden domains and boundaries can be shown by pressing the **View All**, **View Hidden Only**, or **Reset Hiding** button in the Graphic Window toolbar.

Before creating the materials for the model, specify the physics. Using this information, the software can detect which material properties are needed.

ELECTROMAGNETIC WAVES, FREQUENCY DOMAIN (EMW)

Perfect Electric Conductor 2

- 1 In the **Physics** toolbar, click  **Boundaries** and choose **Perfect Electric Conductor**.
- 2 Select Boundaries 15, 20, and 21 only.

Lumped Port 1

- 1 In the **Physics** toolbar, click  **Boundaries** and choose **Lumped Port**.
- 2 In the **Settings** window for **Lumped Port**, locate the **Boundary Selection** section.
- 3 From the **Selection** list, choose **Lumped Port**.

4 Click the  **Zoom In** button in the **Graphics** toolbar.

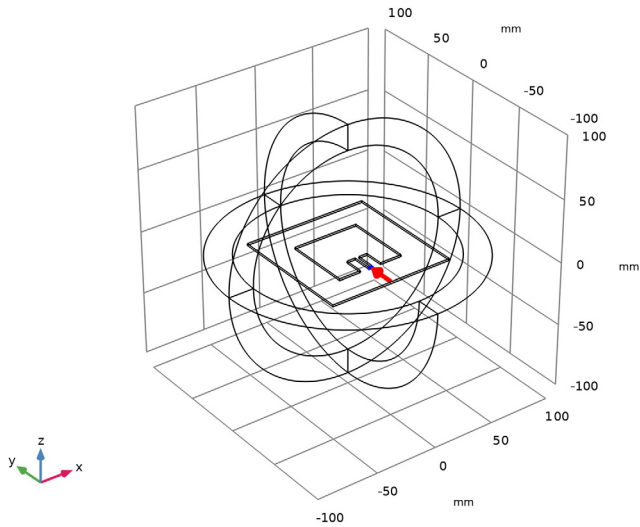



For the first port, wave excitation is **on** by default.

Far-Field Domain 1

In the **Physics** toolbar, click  **Domains** and choose **Far-Field Domain**.

ADD MATERIAL

- 1 In the **Materials** toolbar, click  **Add Material** to open the **Add Material** window.
- 2 Go to the **Add Material** window.
- 3 In the tree, select **Built-in > Air**.
- 4 Click the **Add to Component** button in the window toolbar.
- 5 In the **Materials** toolbar, click  **Add Material** to close the **Add Material** window.

MATERIALS

Substrate

- 1 In the **Model Builder** window, under **Component 1 (comp1)** right-click **Materials** and choose **Blank Material**.
- 2 In the **Settings** window for **Material**, type Substrate in the **Label** text field.

3 Locate the **Geometric Entity Selection** section. From the **Selection** list, choose **Substrate**.

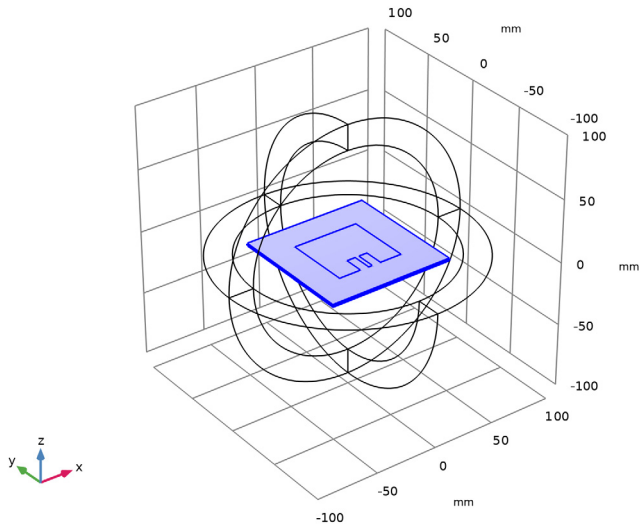

4 Locate the **Material Contents** section. In the table, enter the following settings:

Property	Variable	Value	Unit	Property group
Relative permittivity	epsilon _{nr_ii} ; epsilon _{nr_ii} = epsilon _{nr_ii} , epsilon _{nr_ij} = 0	3.38		Basic
Relative permeability	mu _{r_ii} ; mu _{r_ii} ; mu _{r_ii} = mu _{r_ii} , mu _{r_ij} = 0	1		Basic
Electric conductivity	sigma _{ii} ; sigma _{ii} = sigma _{ii} , sigma _{ij} = 0	0	S/m	Basic

MESH 1

In the **Model Builder** window, under **Component 1 (comp1)** right-click **Mesh 1** and choose **Build All**.

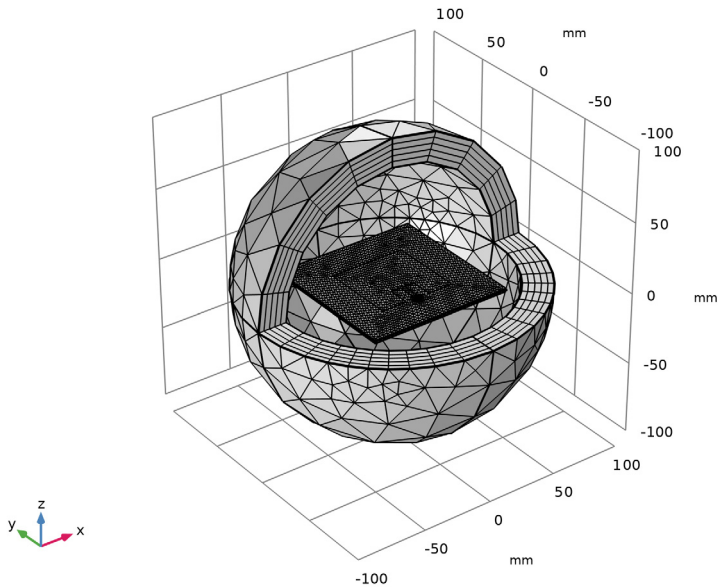

STUDY 1

In the **Study** toolbar, click **Compute**.

RESULTS

Multislice 1

- 1 In the **Model Builder** window, expand the **Results > Electric Field (emw)** node, then click **Multislice 1**.
- 2 In the **Settings** window for **Multislice**, locate the **Multipane Data** section.
- 3 Find the **X-planes** subsection. In the **Planes** text field, type 0.
- 4 Find the **Y-planes** subsection. In the **Planes** text field, type 0.
- 5 Locate the **Coloring and Style** section. From the **Color table** list, choose **ThermalDark**.

Selection 1

- 1 Right-click **Multislice 1** and choose **Selection**.
- 2 Select Domains 6 and 7 only.

Electric Field (emw)

- 1 In the **Model Builder** window, under **Results** click **Electric Field (emw)**.
- 2 In the **Settings** window for **3D Plot Group**, locate the **Plot Settings** section.
- 3 Clear the **Plot dataset edges** checkbox.

Arrow Volume 1

- 1 Right-click **Electric Field (emw)** and choose **Arrow Volume**.
- 2 In the **Electric Field (emw)** toolbar, click  **Plot**.
- 3 In the **Model Builder** window, click **Arrow Volume 1**.
- 4 In the **Settings** window for **Arrow Volume**, locate the **Arrow Positioning** section.
- 5 Find the **X grid points** subsection. In the **Points** text field, type 1.
- 6 Find the **Y grid points** subsection. In the **Points** text field, type 31.
- 7 Find the **Z grid points** subsection. In the **Points** text field, type 31.
- 8 Locate the **Coloring and Style** section. From the **Arrow length** list, choose **Logarithmic**.

Selection 1

- 1 Right-click **Arrow Volume 1** and choose **Selection**.
- 2 Select Domain 5 only.

Color Expression 1

- 1 In the **Model Builder** window, right-click **Arrow Volume 1** and choose **Color Expression**.
- 2 In the **Settings** window for **Color Expression**, locate the **Expression** section.
- 3 In the **Expression** text field, type $20 * \log_{10}(\text{emw}.\text{normE})$.
- 4 In the **Electric Field (emw)** toolbar, click  **Plot**.

Strong electric fields are observed on the radiating edges. See [Figure 3](#) and check the dominant polarization at the boresight.

Electric Field, Logarithmic (emw)

In the **Model Builder** window, under **Results** click **Electric Field, Logarithmic (emw)**.

freq(1)=1.575 GHz Surface: 1 (1) Multislice: Electric field norm (V/m) Surface: Electric field norm (V/m)

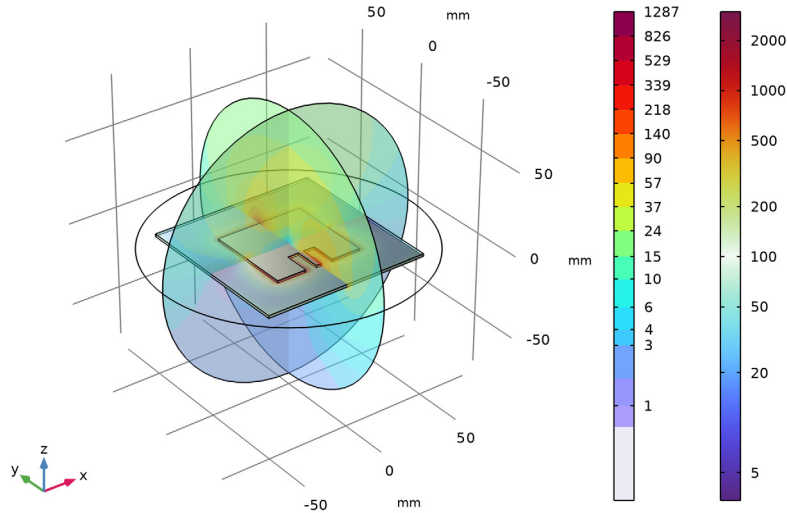

2D Far Field (emw)

- 1 In the **Model Builder** window, click **2D Far Field (emw)**.
- 2 In the **Settings** window for **Polar Plot Group**, click to expand the **Title** section.
- 3 From the **Title type** list, choose **Manual**.
- 4 In the **Title** text area, type Far-field gain, dBi.

Radiation Pattern I

- 1 In the **Model Builder** window, expand the **2D Far Field (emw)** node, then click **Radiation Pattern I**.
- 2 In the **Settings** window for **Radiation Pattern**, click **Replace Expression** in the upper-right corner of the **Expression** section. From the menu, choose **Component I (comp1) > Electromagnetic Waves, Frequency Domain > Far field > emw.gaindBefar - Far-field gain, dBi - dB**.
- 3 Locate the **Evaluation** section. Find the **Reference direction** subsection. In the **x** text field, type 0.
- 4 In the **y** text field, type 1.
- 5 Find the **Normal vector** subsection. In the **x** text field, type 1.

- 6 In the **z** text field, type 0.
- 7 Click to expand the **Legends** section. From the **Legends** list, choose **Manual**.
- 8 In the table, enter the following settings:

Legends
E-plane

Radiation Pattern 2

- 1 Right-click **Results > 2D Far Field (emw) > Radiation Pattern 1** and choose **Duplicate**.
- 2 In the **Settings** window for **Radiation Pattern**, locate the **Evaluation** section.
- 3 Find the **Normal vector** subsection. In the **x** text field, type 0.
- 4 In the **y** text field, type -1.
- 5 Find the **Reference direction** subsection. In the **x** text field, type 1.
- 6 In the **y** text field, type 0.
- 7 Click to expand the **Coloring and Style** section. Find the **Line style** subsection. From the **Line** list, choose **Dashed**.
- 8 Locate the **Legends** section. In the table, enter the following settings:

Legends
H-plane

- 9 In the **2D Far Field (emw)** toolbar, click  **Plot**.

This is the far-field gain patterns on the E- and H-plane (Figure 4). The E- and H-plane of a linearly polarized antenna are defined by the dominant polarization at the boresight. The E-plane includes the main polarization, E_y in this model, while the H-plane is perpendicular to the main polarization.

Radiation Pattern 1

The default 3D far-field plot evaluates the norm of the electric far field that is calculated from the near field using the Stratton-Chu formula. When the 3D far-field is visualized and **Compute directivity** is on, it also calculates the maximum directivity of an antenna. The default **Directivity expression** for **Electromagnetic Waves, Frequency Domain** is set to $emw.normEfar^2$, since antenna directivity is defined by the maximum radiation intensity, that is, the maximum power density per unit solid angle. The directivity calculation is used not only for electromagnetics but also for other physics such as acoustics, where the **Directivity expression** has a different input expression. The calculated maximum directivity value for the microstrip patch antenna is around 6.9 dB.

Annotation 1

- 1 In the **Model Builder** window, expand the **Results > 3D Far Field, Gain (emw)** node.
- 2 Right-click **3D Far Field, Gain (emw)** and choose **Annotation**.
- 3 In the **Settings** window for **Annotation**, locate the **Annotation** section.
- 4 In the **Text** text field, type Maximum directivity: 6.9 dB.
- 5 Locate the **Position** section. In the **Z** text field, type 1.71.
The location is set based on the maximum value of $\text{normE}_{\text{far}}$ at the antenna boresight.
- 6 Locate the **Coloring and Style** section. From the **Background color** list, choose **White**.
- 7 Select the **Show frame** checkbox.
- 8 In the **3D Far Field, Gain (emw)** toolbar, click  **Plot**.

Compare the 3D far-field radiation pattern plot with [Figure 5](#).

Inspect the input matching property (S_{11}) at the simulated frequency.

3D Plot Group 6

- 1 In the **Model Builder** window, expand the **Results > Derived Values** node.
- 2 Right-click **Results** and choose **3D Plot Group**.
- 3 In the **Settings** window for **3D Plot Group**, locate the **Plot Settings** section.
- 4 Clear the **Plot dataset edges** checkbox.

Isosurface 1

- 1 Right-click **3D Plot Group 6** and choose **Isosurface**.
- 2 In the **Settings** window for **Isosurface**, locate the **Expression** section.
- 3 In the **Expression** text field, type $20 * \log_{10}(\text{emw}.\text{normE})$.
- 4 Locate the **Levels** section. In the **Total levels** text field, type 20.
- 5 Locate the **Coloring and Style** section. From the **Color table** list, choose **Ranitomeya**.

Selection 1

- 1 Right-click **Isosurface 1** and choose **Selection**.
- 2 Select Domains 5–7 only.

Filter 1

- 1 In the **Model Builder** window, right-click **Isosurface 1** and choose **Filter**.
- 2 In the **Settings** window for **Filter**, locate the **Element Selection** section.
- 3 In the **Logical expression for inclusion** text field, type $x > 0$.

Transparency 1

- 1 Right-click **IsoSurface 1** and choose **Transparency**.
- 2 In the **Settings** window for **Transparency**, locate the **Transparency** section.
- 3 Find the **Transparency** subsection. Set the **Transparency** value to **0.7**.

Surface 1

- 1 In the **Model Builder** window, right-click **3D Plot Group 6** and choose **Surface**.
- 2 In the **Settings** window for **Surface**, locate the **Expression** section.
- 3 In the **Expression** text field, type 1.

Selection 1

- 1 Right-click **Surface 1** and choose **Selection**.
- 2 Select Boundary 21 only.

Material Appearance 1

- 1 In the **Model Builder** window, right-click **Surface 1** and choose **Material Appearance**.
- 2 In the **Settings** window for **Material Appearance**, locate the **Appearance** section.
- 3 From the **Appearance** list, choose **Custom**.
- 4 From the **Material type** list, choose **Rose gold**.

Surface 2

- 1 In the **Model Builder** window, right-click **3D Plot Group 6** and choose **Surface**.
- 2 In the **Settings** window for **Surface**, locate the **Coloring and Style** section.
- 3 From the **Color table** list, choose **Avicularia**.

Selection 1



- 1 Right-click **Surface 2** and choose **Selection**.
- 2 Select Boundaries 13, 14, 16, 17, and 48 only.
- 3 In the **3D Plot Group 6** toolbar, click  **Plot**.

Figure 6 shows the above isosurface plot.

Note that the following simulation requires more than 5 GB RAM.

In order to have the S-parameter plot of the microstrip patch antenna with a fine frequency resolution, analyze the model using **Adaptive Frequency Sweep** based on asymptotic waveform evaluation (AWE). When a device presents a slowly varying frequency response, the AWE solver is much faster than the regular frequency domain solver, when running the simulation for many frequency points.

ADD STUDY

- 1 In the **Home** toolbar, click  **Add Study** to open the **Add Study** window.
- 2 Go to the **Add Study** window.
- 3 Find the **Studies** subsection. In the **Select Study** tree, select **Preset Studies for Selected Physics Interfaces > Adaptive Frequency Sweep**.
- 4 Click the **Add Study** button in the window toolbar.
- 5 In the **Home** toolbar, click  **Add Study** to close the **Add Study** window.

STUDY 2

- 1 In the **Settings** window for **Study**, locate the **Study Settings** section.
- 2 Clear the **Generate default plots** checkbox.

Step 1: Adaptive Frequency Sweep

- 1 In the **Model Builder** window, under **Study 2** click **Step 1: Adaptive Frequency Sweep**.
- 2 In the **Settings** window for **Adaptive Frequency Sweep**, locate the **Study Settings** section.
- 3 In the **Frequencies** text field, type `range(freq_min, 100[kHz], freq_max)`.

A slowly varying scalar value curve works well for AWE expressions. For one-port devices like antennas, a trivial AWE expression is S_{11} . However, if the frequency response of the AWE expression contains an infinite gradient — the case for the S_{11} value of an antenna, with excellent impedance matching at a single frequency point — the simulation will take longer to complete. If the loss from the antenna is negligible, an alternative expression such as $\sqrt{1 - \text{abs}(\text{comp1}.\text{emw}.S_{11})^2}$ may work well and reduce the computation time. When **AWE expression type** is set to **Physics controlled** in the **Adaptive Frequency Sweep** study settings, $\sqrt{1 - \text{abs}(\text{comp1}.\text{emw}.S_{11})^2}$ is used automatically for one-port devices.

Because such a fine frequency step generates a memory-intensive solution, the model file size will increase tremendously when it is saved. When only the frequency response of port related variables is of interest, it is not necessary to store all of the field solutions. By selecting the **Store in Output** checkbox in the **Values of Dependent Variables** section, we can control the part of the model on which the computed solution is saved. We only add the selection containing the boundaries where the port variables are calculated. The lumped port size is typically very small compared to the entire modeling domain, and the saved file size with the fine frequency step is more or less that of the regular discrete frequency sweep model when only the solutions on the lumped port boundaries are stored.

4 Click to expand the **Store in Output** section. In the table, enter the following settings:

Interface	Output
Electromagnetic Waves, Frequency Domain (emw)	Selection

5 Click to select the first row in the table.

6 Under **Selections**, click  **Add**.

7 In the **Add** dialog, select **Lumped Port** in the **Selections** list.

8 Click **OK**.

It is necessary to include the lumped port boundaries to calculate the S-parameters. By choosing only the lumped port boundaries for **Store in Output** settings, it is possible to significantly reduce the size of the model file.

9 In the **Study** toolbar, click  **Compute**.

RESULTS

S-parameter, Asymptotic Waveform Evaluation

1 In the **Results** toolbar, click  **ID Plot Group**.

2 In the **Settings** window for **ID Plot Group**, type S-parameter, Asymptotic Waveform Evaluation in the **Label** text field.

3 Locate the **Data** section. From the **Dataset** list, choose **Probe Solution 2 (sol2)**.

4 Click to expand the **Title** section. From the **Title type** list, choose **Manual**.

5 In the **Title** text area, type Adaptive Frequency Sweep, Microstrip Patch Antenna.

6 Locate the **Legend** section. From the **Position** list, choose **Lower right**.

Global 1

1 Right-click **S-parameter, Asymptotic Waveform Evaluation** and choose **Global**.

2 In the **Settings** window for **Global**, click **Add Expression** in the upper-right corner of the **y-Axis Data** section. From the menu, choose **Component 1 (comp1) > Electromagnetic Waves, Frequency Domain > Ports > emw.S11 dB - S11 - dB**.

3 In the **S-parameter, Asymptotic Waveform Evaluation** toolbar, click  **Plot**.

Review the S-parameter plot in [Figure 7](#).

The following instructions show how to perform a quick evaluation of the far-field radiation pattern of an antenna array using the uniform array factor operator.

Array Factor 1

- 1 In the **Results** toolbar, click  **More Datasets** and choose **Array Factor**.
- 2 In the **Settings** window for **Array Factor**, locate the **Array Definition** section.
- 3 In row **Array size**, set **x** to 8.
- 4 In row **Array size**, set **y** to 8.
- 5 In row **Displacement**, set **x** to 0.48.
- 6 In row **Displacement**, set **y** to 0.48.
- 7 Locate the **Evaluation** section. From the **Scale** list, choose **dB**.
- 8 Select the **Normalization** checkbox.

3D Far Field, Virtual Array

- 1 In the **Results** toolbar, click  **3D Plot Group**.
- 2 In the **Settings** window for **3D Plot Group**, type 3D Far Field, Virtual Array in the **Label** text field.
- 3 Locate the **Data** section. From the **Dataset** list, choose **Array Factor 1**.
- 4 Locate the **Color Legend** section. Select the **Show maximum and minimum values** checkbox.

Radiation Pattern 1

- 1 In the **3D Far Field, Virtual Array** toolbar, click  **More Plots** and choose **Radiation Pattern**.
- 2 In the **Settings** window for **Radiation Pattern**, locate the **Expression** section.
- 3 In the **Expression** text field, type `emw.gaindBefar`.

Combined with the **Array Factor** dataset, the plot expression used above is equivalent to `emw.gaindBefar+20*log10(emw.af3(8,8,1,0.48,0.48,0,0,0,0))+10*log10(1/64)`.

See the [Results and Discussion](#) section for the usage of the uniform array factor operator `af3`.

- 4 Select the **Threshold** checkbox. In the associated text field, type -30.
- 5 Locate the **Evaluation** section. Find the **Angles** subsection. In the **Number of elevation angles** text field, type 180.
- 6 In the **Number of azimuth angles** text field, type 180.
- 7 Locate the **Coloring and Style** section. From the **Color table** list, choose **HeatCamera**.

8 In the **3D Far Field, Virtual Array** toolbar, click  **Plot**.

The far-field radiation pattern of a virtual 8x8 microstrip patch antenna array is plotted in [Figure 8](#).

Array Factor 2

1 In the **Model Builder** window, under **Results > Datasets** right-click **Array Factor 1** and choose **Duplicate**.

2 In the **Settings** window for **Array Factor**, locate the **Array Definition** section.

3 In row **Phase shift**, set **x** to $-2*\pi*0.48*\cos(\pi/3)$.

2D Far Field Gain (dB), Virtual Array

1 In the **Results** toolbar, click  **Polar Plot Group**.

2 In the **Settings** window for **Polar Plot Group**, type 2D Far Field Gain (dB), Virtual Array in the **Label** text field.

3 Locate the **Title** section. From the **Title type** list, choose **Manual**.

4 In the **Title** text area, type 8x8 Microstrip Patch Antenna Array.

5 Locate the **Axis** section. Select the **Manual axis limits** checkbox.

6 In the **r minimum** text field, type -15.

7 In the **r maximum** text field, type 25.

8 Locate the **Legend** section. From the **Position** list, choose **Upper left**.

Radiation Pattern 1

1 In the **2D Far Field Gain (dB), Virtual Array** toolbar, click  **More Plots** and choose **Radiation Pattern**.

2 In the **Settings** window for **Radiation Pattern**, locate the **Expression** section.

3 In the **Expression** text field, type `emw.gaindBefar`.

4 Locate the **Evaluation** section. Find the **Angles** subsection. In the **Number of angles** text field, type 360.

5 Find the **Normal vector** subsection. In the **y** text field, type -1.

6 In the **z** text field, type 0.

7 Locate the **Legends** section. Select the **Show legends** checkbox.

8 From the **Legends** list, choose **Manual**.

9 In the table, enter the following settings:

Legends
Single patch antenna gain

10 In the **2D Far Field Gain (dB), Virtual Array** toolbar, click  **Plot**.

Radiation Pattern 2

- 1 Right-click **Radiation Pattern 1** and choose **Duplicate**.
- 2 In the **Settings** window for **Radiation Pattern**, locate the **Data** section.
- 3 From the **Dataset** list, choose **Array Factor 2**.
- 4 Locate the **Expression** section. In the **Expression** text field, type 1.
- 5 Locate the **Legends** section. In the table, enter the following settings:

Legends

8x8 uniform array factor

6 In the **2D Far Field Gain (dB), Virtual Array** toolbar, click  **Plot**.

Radiation Pattern 3

- 1 Right-click **Radiation Pattern 2** and choose **Duplicate**.
- 2 In the **Settings** window for **Radiation Pattern**, locate the **Data** section.
- 3 From the **Dataset** list, choose **Array Factor 2**.
- 4 Locate the **Expression** section. In the **Expression** text field, type `emw.gaindBefar`.
- 5 Locate the **Legends** section. In the table, enter the following settings:

Legends

8x8 patch antenna array gain

6 In the **2D Far Field Gain (dB), Virtual Array** toolbar, click  **Plot**.

See [Figure 9](#) for the dB-scaled gain of the virtual 8x8 microstrip patch antenna array. It is plotted with the uniform array factor which has the maximum radiation at 60 degrees from the x -axis.