



Model created in COMSOL Multiphysics 6.4

# Lightning Surge on a Power Transmission Tower

## Introduction

---

In the realm of high-voltage transmission systems, the resilience of power infrastructure against lightning strikes is of paramount importance. Lightning strikes can cause transient overvoltages that lead to system failures, equipment damage, and even disruption of power supply. This model aims to address these concerns by simulating the effects of lightning surges on high-voltage transmission line towers. By examining the induced voltage on three-phase conductors resulting from a lightning strike, it allows for the assessment of potential overvoltages and helps in designing effective protection measures. This model specifically focuses on lightning carrying a current of 10 kA that strikes one of the tower's shielded wires. The induced voltage on the three-phase conductors is computed through rigorous simulation techniques. Noteworthy aspects of the model include the accurate representation of the transmission tower geometry, the complex parabolic shape of the hanging transmission lines, and the irregularities of the ground surface. Additionally, the model enables users to define the lightning strike channel arbitrarily and automates the definition of the propagating strike current.

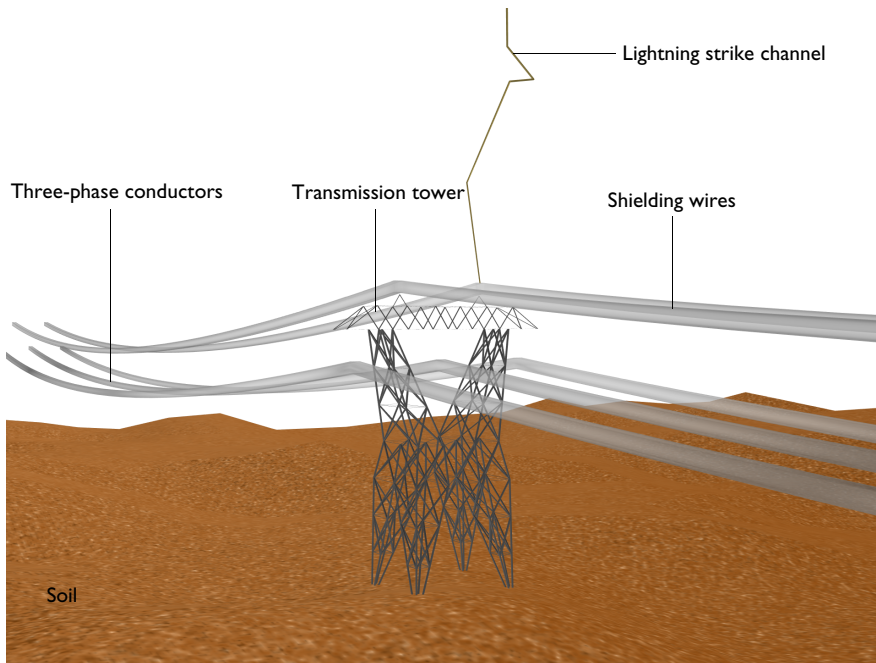

*Figure 1: A tower positioned over the soil is connected to two shielding wires and three three-phase conductors.*

## *Model Definition*

---

The example model incorporates a realistic representation of a high-voltage transmission line tower. The geometry captures the tower structure, including its cross-arms, and conductors while insulators are omitted. The transmission lines are modeled with a parabolic shape, which affects the distribution of induced voltages during a lightning surge. The ground surface is also accounted for, considering its irregularities that impact the surge propagation.

A customized meshing is conducted to ensure numerical stability and accuracy. Fine meshing near critical areas such as conductor-to-air interfaces and areas of significant electric field variation ensures reliable results.

The model employs electromagnetic and transient physics modules to simulate the lightning surge phenomenon. Maxwell's equations are solved to analyze the electromagnetic fields induced by the lightning strike. The boundary conditions encompass numerical representations of the wire conductors, tower surfaces, and lightning channel. Transient analysis captures the time-dependent behavior of the lightning surge, considering the rapid transient changes caused by the strike.

One of the model's strengths is the flexibility in defining the lightning strike channel. Users can input various strike paths, allowing for a wide range of scenarios and strike angles to be considered. This feature accommodates different lightning behavior patterns and enables thorough exploration of potential outcomes.

The edge current feature also incorporates an automated definition of the propagating strike current. This current distribution follows the principles of lightning physics, considering factors such as the leader progression and return stroke characteristics. The dynamic nature of the propagating current adds another layer of realism to the simulation.

The tower body is treated as a perfect electric conductor, under the assumption that the loss from the metal's finite conductivity is insignificant. The outer boundary of the model domain adopts a scattering boundary condition to reduce any reflections, simulating an expansive open space.

Concerning the modeling techniques for the wires, including the construction of geometry and meshing used in this example, the model [Lightning-Induced Voltage of an Overhead Line Over Lossy Ground](#) — also included in the RF Module Application Library — provides a comprehensive overview of the efficient numerical modeling process.

## Results and Discussion

The primary output of the simulation is the induced voltage at the three-phase conductors of the transmission tower. These induced voltages (Figure 2) are critical indicators of potential overvoltages that might affect the power system. Analyzing the magnitude and distribution of these induced voltages offers insights into areas of vulnerability and aids in designing appropriate protection measures.

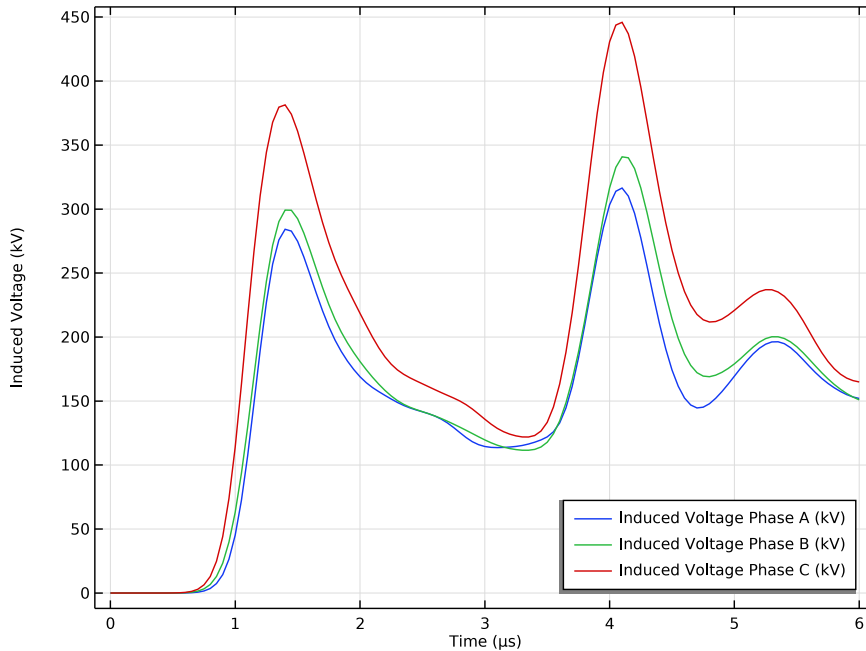
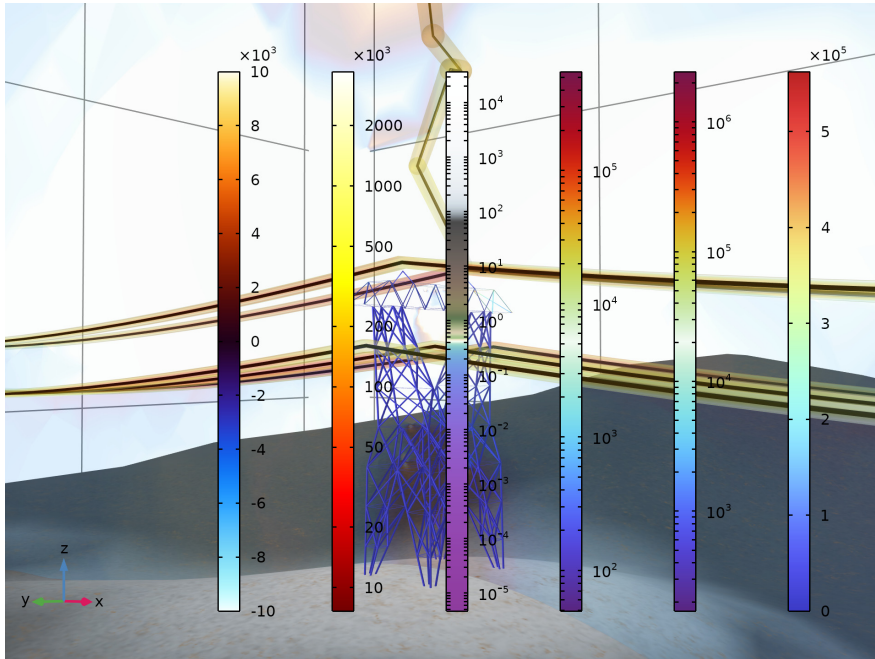

Figure 2: The induced voltage plot of three-phase conductors.

Insights into the electric field distribution, current flow paths, and potential points of high stress help refine tower design for better lightning resilience. For illustrative purposes, the magnitude of the electric fields is displayed on the lightning channel, tower, soil, and wires in the Figure 3.



*Figure 3: The norm of the electric field distribution caused by a lightning strike.*

This model stands as a guidance for investigating the effects of lightning surges on high-voltage transmission line towers. Its capabilities in representing tower geometry, strike channel definition, and propagating strike current automate the analysis process while maintaining a fidelity. By comprehensively assessing induced voltages and their distribution, the resilience of power infrastructure against lightning-induced disruptions can be enhanced.

### *Reference*

1. [www.comsol.com/blogs/what-is-gauge-fixing-a-theoretical-introduction](http://www.comsol.com/blogs/what-is-gauge-fixing-a-theoretical-introduction)

**Application Library path:** RF\_Module/ESD\_and\_Lightning\_Surge/  
lightning\_surge\_tower

## *Modeling Instructions*



---

From the **File** menu, choose **New**.

### **NEW**

In the **New** window, click  **Model Wizard**.

### **MODEL WIZARD**

- 1 In the **Model Wizard** window, click  **3D**.
- 2 In the **Select Physics** tree, select **Radio Frequency > Electromagnetic Waves, Transient (temw)**.
- 3 Click **Add**.
- 4 Click  **Study**.
- 5 In the **Select Study** tree, select **General Studies > Time Dependent**.
- 6 Click  **Done**.

### **GLOBAL DEFINITIONS**

#### *Parameters I*

- 1 In the **Model Builder** window, under **Global Definitions** click **Parameters I**.
- 2 In the **Settings** window for **Parameters**, locate the **Parameters** section.

3 In the table, enter the following settings:

Name	Expression	Value	Description
ds	1[m]	1 m	Thin wire domain mesh size
r_sw	1[cm]	0.01 m	Radius of the shielding wire
epsilon_r_sw	$\log(1/0.23) / \log(ds/r\_sw)$	0.31914	Modified relative permittivity
mu_r_sw	1/epsilon_r_sw	3.1335	Modified relative permeability
r_pc	10[cm]	0.1 m	Radius of the phase conductor
epsilon_r_pc	$\log(1/0.23) / \log(ds/r\_pc)$	0.63827	Modified relative permittivity
mu_r_pc	1/epsilon_r_pc	1.5667	Modified relative permeability
sigma_soil	0.01[S/m]	0.01 S/m	Soil conductivity

Add a part that will be used for the soil surface.

4 In the **Model Builder** window, right-click **Global Definitions** and choose **Geometry Parts > Part Libraries**.

#### PART LIBRARIES

1 In the **Part Libraries** window, select **COMSOL Multiphysics > Random Surfaces > random\_flat\_surface** in the tree.

2 Click  **Add to Model**.

3 In the **Select Part Variant** dialog, select **Specify amplitude scale factor** in the **Select part variant** list.

4 Click **OK**.

## RANDOM FLAT SURFACE

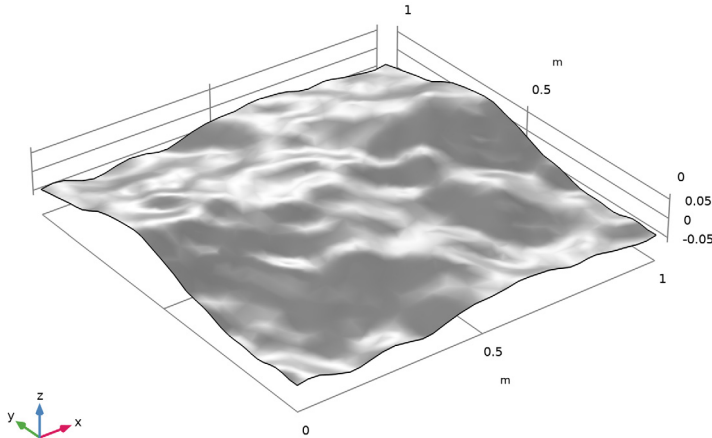

In the **Model Builder** window, under **Global Definitions** > **Geometry Parts** click **Random Flat Surface**.



Import the power transmission tower geometry.

## GEOMETRY I



*Import 1 (imp1)*

- 1 In the **Geometry** toolbar, click  **Import**.
- 2 In the **Settings** window for **Import**, locate the **Source** section.
- 3 From the **Source** list, choose **COMSOL Multiphysics file**.
- 4 In the **Filename** text field, type lightning\_surge\_tower\_geom.mphbin.
- 5 Click  **Build Selected**.
- 6 Click to expand the **Selections of Resulting Entities** section. Find the **Cumulative selection** subsection. Click **New**.
- 7 In the **New Cumulative Selection** dialog, **Cumulative selection** helps configure boundaries condition and material properties.
- 8 type Tower in the **Name** text field.

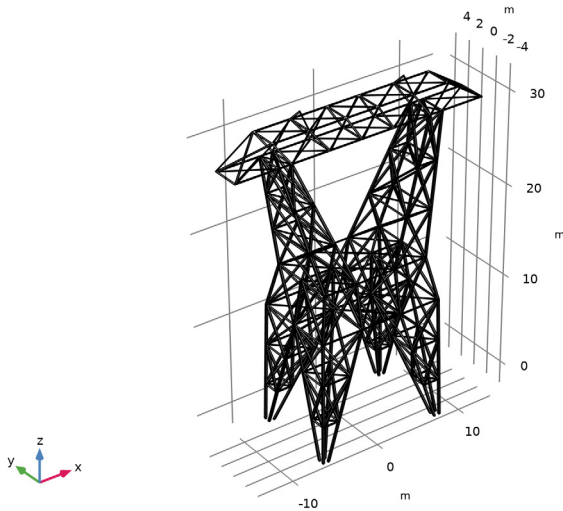
9 Click **OK**.





#### *Scale 1 (sca1)*

- 1 In the **Geometry** toolbar, click  **Transforms** and choose **Scale**.
- 2 Select the object **imp1** only.
- 3 In the **Settings** window for **Scale**, locate the **Scale Factor** section.
- 4 In the **Factor** text field, type 1.5.
- 5 Click  **Build Selected**.



Add the part representing the soil surface.

#### *Random Flat Surface 1 (pil)*



- 1 In the **Geometry** toolbar, click  **Part Instance** and choose **Random Flat Surface**.
- 2 In the **Settings** window for **Part Instance**, locate the **Position and Orientation of Output** section.
- 3 Find the **Displacement** subsection. In the **xwi** text field, type -0.6.
- 4 In the **ywi** text field, type -0.6.
- 5 Click  **Build Selected**.
- 6 Click the  **Go to Default View** button in the **Graphics** toolbar.

#### *Scale 2 (sca2)*

- 1 In the **Geometry** toolbar, click  **Transforms** and choose **Scale**.

- 2 Select the object **pi1** only.
- 3 In the **Settings** window for **Scale**, locate the **Scale Factor** section.
- 4 In the **Factor** text field, type 1200.
- 5 Click  **Build Selected**.
- 6 Click the  **Go to Default View** button in the **Graphics** toolbar.

*Move 1 (mov1)*

- 1 In the **Geometry** toolbar, click  **Transforms** and choose **Move**.
- 2 Select the object **sca2** only.
- 3 In the **Settings** window for **Move**, locate the **Displacement** section.
- 4 In the **x** text field, type 35.
- 5 In the **y** text field, type 10.
- 6 In the **z** text field, type -40.
- 7 Click  **Build Selected**.

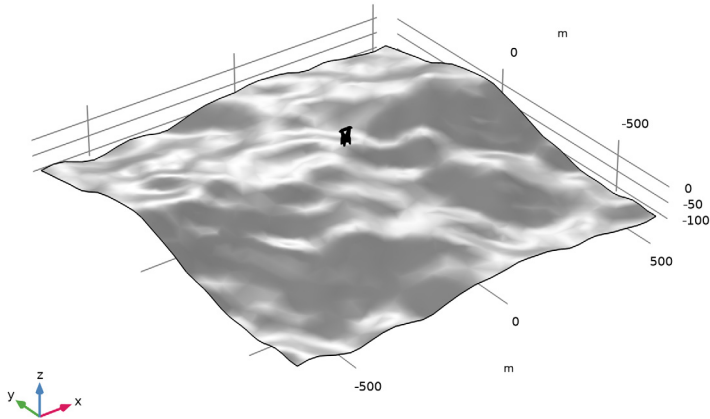

Draw a wire using a **Parametric Curve**.

*Parametric Curve 1 (pc1)*

- 1 In the **Geometry** toolbar, click  **More Primitives** and choose **Parametric Curve**.
- 2 In the **Settings** window for **Parametric Curve**, locate the **Parameter** section.
- 3 In the **Minimum** text field, type -200.

- 4 In the **Maximum** text field, type 200.
- 5 Locate the **Expressions** section. In the **x** text field, type -18.
- 6 In the **y** text field, type s.
- 7 In the **z** text field, type  $s^2/3e3+23$ .
- 8 Locate the **Position** section. In the **y** text field, type 200.

By sweeping a small square patch along the wire, create an effective area of a transmission line.

*Work Plane 1 (wp1)*

- 1 In the **Geometry** toolbar, click  **Work Plane**.
- 2 In the **Settings** window for **Work Plane**, locate the **Plane Definition** section.
- 3 From the **Plane** list, choose **xz-plane**.

*Work Plane 1 (wp1) > Plane Geometry*

In the **Model Builder** window, click **Plane Geometry**.

*Work Plane 1 (wp1) > Square 1 (sq1)*

- 1 In the **Work Plane** toolbar, click  **Square**.
- 2 In the **Settings** window for **Square**, locate the **Size** section.
- 3 In the **Side length** text field, type 2.
- 4 Locate the **Position** section. From the **Base** list, choose **Center**.
- 5 In the **xw** text field, type -18.
- 6 In the **yw** text field, type  $23+40/3$ .
- 7 Click to expand the **Layers** section. In the table, enter the following settings:

Layer name	Thickness (m)
Layer 1	1



- 8 Select the **Layers to the left** checkbox.

*Work Plane 1 (wp1)*

- 1 In the **Model Builder** window, under **Component 1 (comp1) > Geometry 1** click **Work Plane 1 (wp1)**.
- 2 In the **Settings** window for **Work Plane**, click  **Build Selected**.

*Sweep 1 (sw1)*

- 1 In the **Geometry** toolbar, click  **Sweep**.
- 2 On the object **wp1**, select Boundaries 1–4 only.

- 3 In the **Settings** window for **Sweep**, locate the **Spine Curve** section.
- 4 Click to select the  **Activate Selection** toggle button for **Edges to follow**.
- 5 On the object **pci**, select Edge 1 only.
- 6 Locate the **Input Object Handling** section. Clear the **Keep input objects** checkbox.
- 7 Click  **Build Selected**.

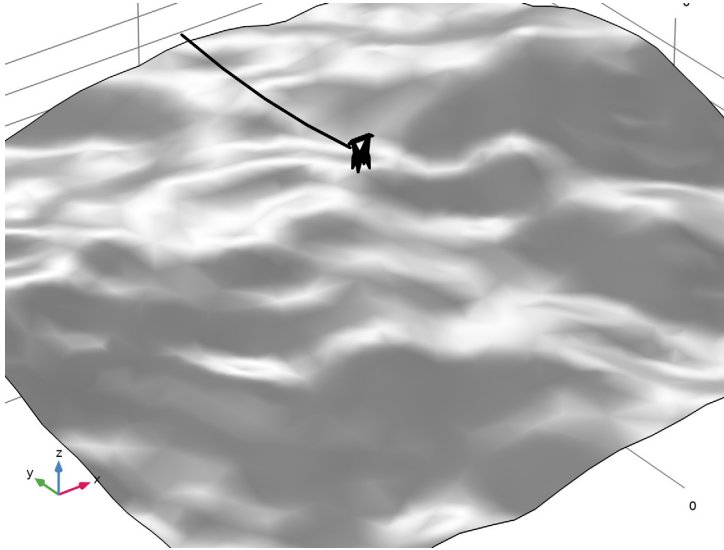

Copy the wire representation to add one for a shield wire.

*Copy 1 (copy1)*

In the **Geometry** toolbar, click  **Transforms** and choose **Copy**.

*Sweep 1 (swe1)*

1 In the **Model Builder** window, click **Sweep 1 (swe1)**.

2 Select the object **swe1** only.

*Copy 1 (copy1)*

1 In the **Model Builder** window, click **Copy 1 (copy1)**.

2 Select the object **swe1** only.

3 Click the  **Zoom to Selection** button in the **Graphics** toolbar.

4 Click the  **Zoom Out** button in the **Graphics** toolbar.

5 In the **Settings** window for **Copy**, locate the **Displacement** section.

6 In the **x** text field, type 9.

7 In the **z** text field, type 14.

8 Click  **Build Selected**.

Using an **Array**, create three three-phase conductors.

*Array 1 (arr1)*

1 In the **Geometry** toolbar, click  **Transforms** and choose **Array**.

2 Select the object **swel** only.

3 In the **Settings** window for **Array**, locate the **Size** section.

4 In the **x size** text field, type 3.

5 Locate the **Displacement** section. In the **x** text field, type 18.

6 Click  **Build Selected**.

7 Locate the **Selections of Resulting Entities** section. Find the **Cumulative selection** subsection. Click **New**.

8 In the **New Cumulative Selection** dialog, **Cumulative selection** helps configure boundaries condition and material properties.

9 type Phase Conductor in the **Name** text field.

10 Click **OK**.

11 In the **Settings** window for **Array**, click  **Build Selected**.

Using an **Array**, create two shield wires.

*Array 2 (arr2)*

1 In the **Geometry** toolbar, click  **Transforms** and choose **Array**.

2 Select the object **copy1** only.

3 In the **Settings** window for **Array**, locate the **Size** section.

4 In the **x size** text field, type 2.

5 Locate the **Displacement** section. In the **x** text field, type 18.

6 Click  **Build Selected**.

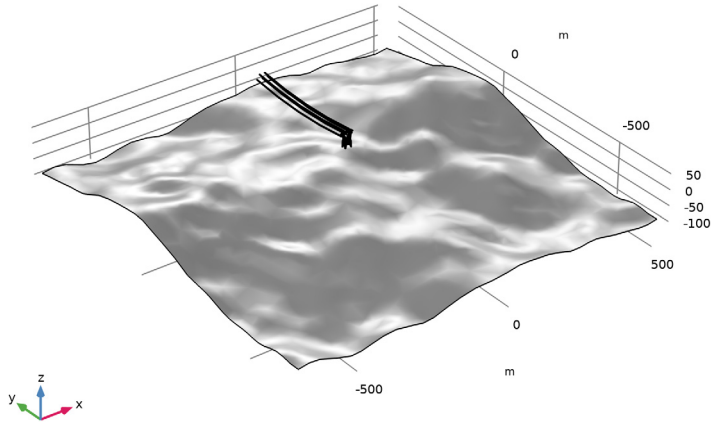

7 Locate the **Selections of Resulting Entities** section. Find the **Cumulative selection** subsection. Click **New**.

8 In the **New Cumulative Selection** dialog, **Cumulative selection** helps configure boundaries condition and material properties.

9 type **Shielding Wire** in the **Name** text field.

10 Click **OK**.

Added small strips to connect the shield wired to the tower.

*Work Plane 2 (wp2)*

1 In the **Geometry** toolbar, click  **Work Plane**.

2 In the **Settings** window for **Work Plane**, locate the **Plane Definition** section.

3 From the **Plane** list, choose **xz-plane**.

*Work Plane 2 (wp2) > Plane Geometry*

In the **Model Builder** window, click **Plane Geometry**.

*Work Plane 2 (wp2) > Rectangle 1 (r1)*

1 In the **Work Plane** toolbar, click  **Rectangle**.

2 In the **Settings** window for **Rectangle**, locate the **Size and Shape** section.

3 In the **Width** text field, type 2.

- 4 In the **Height** text field, type 40/3-12.
- 5 Locate the **Position** section. In the **xw** text field, type -10.
- 6 In the **yw** text field, type 48.

Complete the three-phase conductors and shield wires by mirroring all array objects.

*Work Plane 2 (wp2) > Mirror 1 (mir1)*

- 1 In the **Work Plane** toolbar, click  **Transforms** and choose **Mirror**.
- 2 Select the object **r1** only.
- 3 In the **Settings** window for **Mirror**, locate the **Input** section.
- 4 Select the **Keep input objects** checkbox.

*Work Plane 2 (wp2)*

- 1 In the **Model Builder** window, under **Component 1 (comp1) > Geometry 1** click **Work Plane 2 (wp2)**.
- 2 In the **Settings** window for **Work Plane**, click  **Build Selected**.

*Mirror 1 (mir1)*

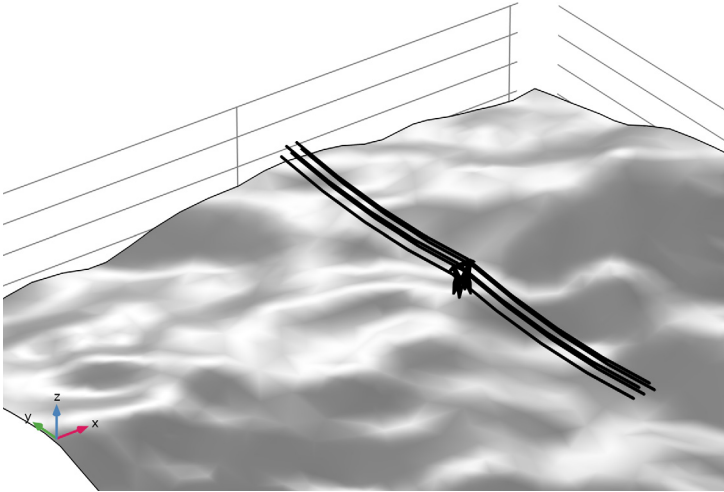

- 1 In the **Geometry** toolbar, click  **Transforms** and choose **Mirror**.
- 2 Select the objects **arr1(1,1,1)**, **arr1(2,1,1)**, **arr1(3,1,1)**, **arr2(1,1,1)**, and **arr2(2,1,1)** only.
- 3 In the **Settings** window for **Mirror**, locate the **Input** section.
- 4 Select the **Keep input objects** checkbox.
- 5 Locate the **Normal Vector to Plane of Reflection** section. In the **y** text field, type -1.
- 6 In the **z** text field, type 0.

7 Click  **Build Selected**.





8 Click the  **Zoom Extents** button in the **Graphics** toolbar.  
Enclose all objects by a block to make the air and soil domains.

*Block 1 (blk1)*

- 1 In the **Geometry** toolbar, click  **Block**.
- 2 In the **Settings** window for **Block**, locate the **Size and Shape** section.
- 3 In the **Width** text field, type 810.
- 4 In the **Depth** text field, type 810.
- 5 In the **Height** text field, type 800.
- 6 Locate the **Position** section. From the **Base** list, choose **Center**.
- 7 In the **z** text field, type 100.
- 8 Click  **Build Selected**.

*Partition Objects 1 (par1)*

- 1 In the **Geometry** toolbar, click  **Booleans and Partitions** and choose **Partition Objects**.
- 2 Select the object **blk1** only.
- 3 In the **Settings** window for **Partition Objects**, locate the **Partition Objects** section.
- 4 Click to select the  **Activate Selection** toggle button for **Tool objects**.
- 5 Select the object **mov1** only.

6 Click  **Build Selected**.

7 Click the  **Wireframe Rendering** button in the **Graphics** toolbar.

Use a **Polygon** to create a lightning channel path.

### *Lightning Channel*

1 In the **Geometry** toolbar, click  **More Primitives** and choose **Polygon**.

2 In the **Settings** window for **Polygon**, type Lightning Channel in the **Label** text field.

3 Locate the **Coordinates** section. Click  **Load from File**.

4 Browse to the model's Application Libraries folder and double-click the file lightning\_surge\_tower\_table.txt.

5 Locate the **Selections of Resulting Entities** section. Select the **Resulting objects selection** checkbox.

6 Click  **Build Selected**.

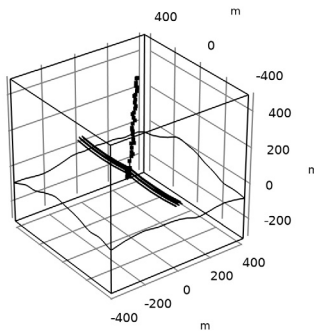

The following **Explicit** selection will be used to deploy numerical characteristics of the three-phase conductors and shield wires.

### **DEFINITIONS**

#### *All Wires*



1 In the **Definitions** toolbar, click  **Explicit**.

2 In the **Settings** window for **Explicit**, type All Wires in the **Label** text field.

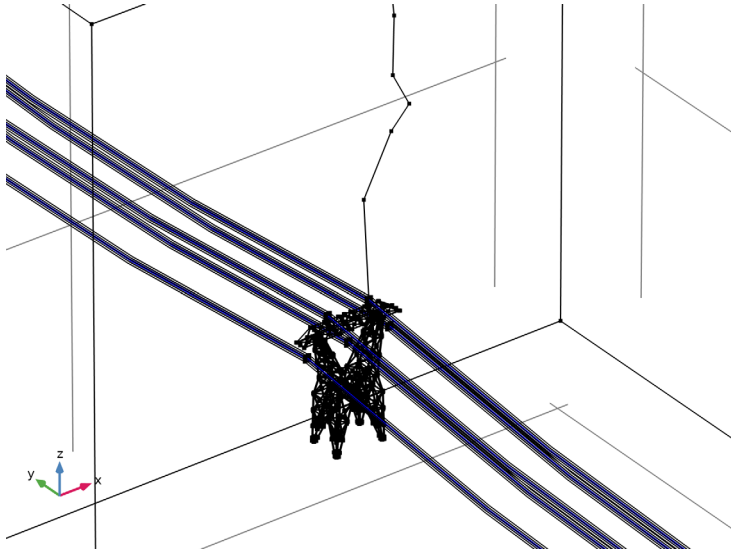
- 3 Locate the **Input Entities** section. From the **Geometric entity level** list, choose **Edge**.
- 4 Click  **Paste Selection**.
- 5 In the **Paste Selection** dialog, type 67, 75, 1365, 1375, 2624, 2654, 4127, 4137, 5205, 5213 in the **Selection** text field.
- 6 Click **OK**.



#### ADD MATERIAL

- 1 In the **Materials** toolbar, click  **Add Material** to open the **Add Material** window.
- 2 Go to the **Add Material** window.
- 3 In the tree, select **Built-in > Air**.
- 4 Click the **Add to Component** button in the window toolbar.
- 5 In the **Materials** toolbar, click  **Add Material** to close the **Add Material** window.

#### MATERIALS

##### Soil

- 1 In the **Model Builder** window, under **Component 1 (comp1)** right-click **Materials** and choose **Blank Material**.
- 2 In the **Settings** window for **Material**, type Soil in the **Label** text field.

3 Select Domain 1 only.

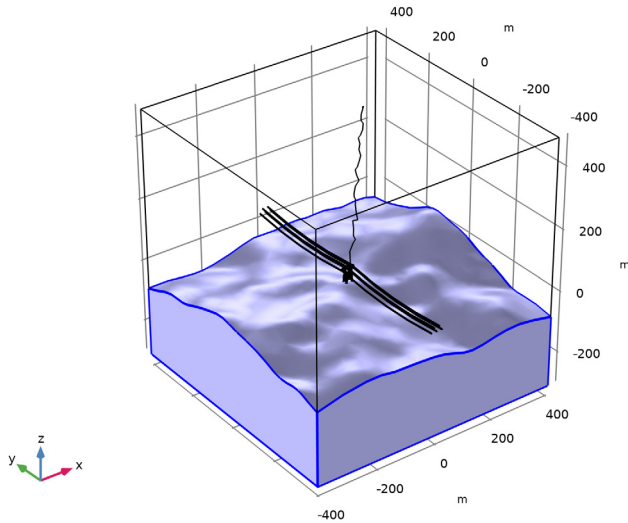

4 Locate the **Material Contents** section. In the table, enter the following settings:

Property	Variable	Value	Unit	Property group
Relative permittivity	epsilon <sub>r_iso</sub> ; epsilon <sub>r_ii</sub> = epsilon <sub>r_iso</sub> , epsilon <sub>r_ij</sub> = 0	1		Basic
Relative permeability	mu <sub>r_iso</sub> ; mu <sub>r_ii</sub> = mu <sub>r_iso</sub> , mu <sub>r_ij</sub> = 0	1		Basic
Electric conductivity	sigma <sub>iso</sub> ; sigma <sub>ii</sub> = sigma <sub>iso</sub> , sigma <sub>ij</sub> = 0	sigma <sub>s</sub> oil	S/m	Basic

#### Shielding Wire Domains

- 1 Right-click **Materials** and choose **Blank Material**.
- 2 In the **Settings** window for **Material**, type Shielding Wire Domains in the **Label** text field.

- 3 Locate the **Geometric Entity Selection** section. From the **Selection** list, choose **Shielding Wire**.

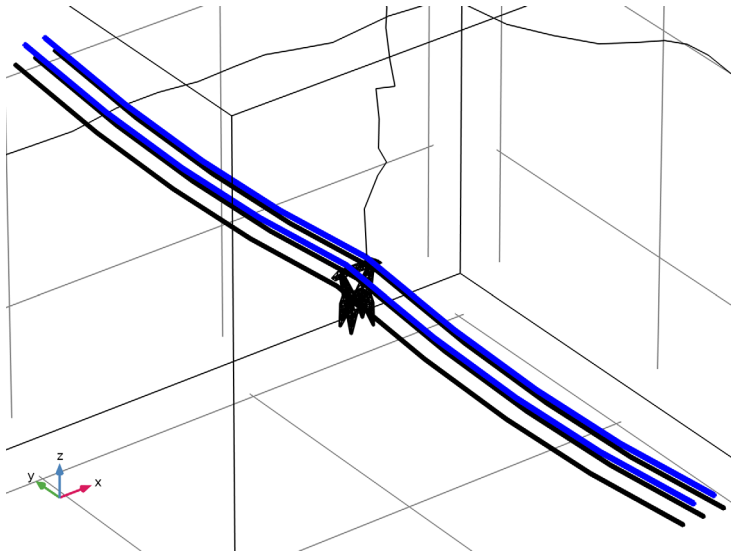

- 4 Locate the **Material Contents** section. In the table, enter the following settings:

Property	Variable	Value	Unit	Property group
Relative permittivity	epsilon <sub>r_</sub> iso ; epsilon <sub>r_</sub> ii = epsilon <sub>r_</sub> iso, epsilon <sub>r_</sub> ij = 0	epsilon <sub>r_</sub> sw	1	Basic
Relative permeability	mu <sub>r_</sub> iso ; mu <sub>r_</sub> ii = mu <sub>r_</sub> iso, mu <sub>r_</sub> ij = 0	mu <sub>r_</sub> sw	1	Basic
Electric conductivity	sigma <sub>iso</sub> ; sigma <sub>ii</sub> = sigma <sub>iso</sub> , sigma <sub>ij</sub> = 0	0	S/m	Basic

#### Phase Conductor Domains

- 1 Right-click **Materials** and choose **Blank Material**.
- 2 In the **Settings** window for **Material**, type Phase Conductor Domains in the **Label** text field.

3 Locate the **Geometric Entity Selection** section. From the **Selection** list, choose **Phase Conductor**.

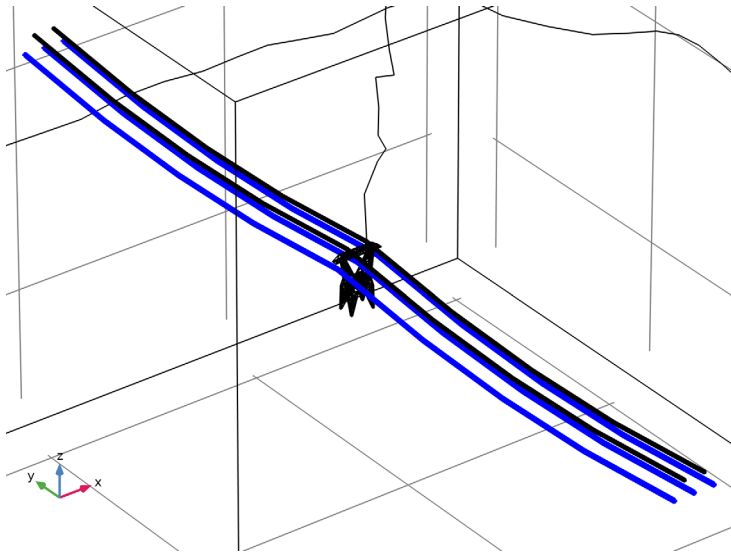

4 Locate the **Material Contents** section. In the table, enter the following settings:



Property	Variable	Value	Unit	Property group
Relative permittivity	epsilon <sub>r_</sub> iso ; epsilon <sub>r_</sub> ii = epsilon <sub>r_</sub> iso, epsilon <sub>r_</sub> ij = 0	epsilon <sub>r_</sub> pc	1	Basic
Relative permeability	mu <sub>r_</sub> iso ; mu <sub>r_</sub> ii = mu <sub>r_</sub> iso, mu <sub>r_</sub> ij = 0	mu <sub>r_</sub> pc	1	Basic
Electric conductivity	sigma <sub>iso</sub> ; sigma <sub>ii</sub> = sigma <sub>iso</sub> , sigma <sub>ij</sub> = 0	0	S/m	Basic

Use the **Linear** discretization to reduce computational costs, though this might compromise accuracy. The model is designed for demonstration with an emphasis on minimizing computational resources.

## ELECTROMAGNETIC WAVES, TRANSIENT (TEMW)

- 1 In the **Model Builder** window, under **Component 1 (comp1)** click **Electromagnetic Waves, Transient (temw)**.
- 2 In the **Settings** window for **Electromagnetic Waves, Transient**, click to expand the **Discretization** section.
- 3 From the **Magnetic vector potential** list, choose **Linear**.

### Scattering Boundary Condition 1

- 1 In the **Physics** toolbar, click  **Boundaries** and choose **Scattering Boundary Condition**.  
The concept of an open space can be represented using the **Scattering Boundary Condition**.
- 2 In the **Settings** window for **Scattering Boundary Condition**, locate the **Boundary Selection** section.
- 3 Click  **Paste Selection**.
- 4 In the **Paste Selection** dialog, type 1-5, 7-9, 2308, 2309 in the **Selection** text field.
- 5 Click **OK**.

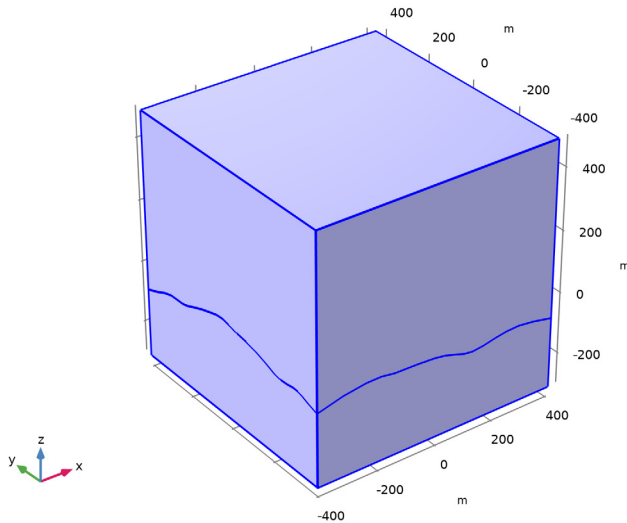

### Perfect Electric Conductor 2

- 1 In the **Physics** toolbar, click  **Boundaries** and choose **Perfect Electric Conductor**.  
To add **Pointwise Constraints, Equation-Based Contributions** needs to be triggered.

- 2 In the **Settings** window for **Perfect Electric Conductor**, locate the **Boundary Selection** section.
- 3 From the **Selection** list, choose **Tower**.

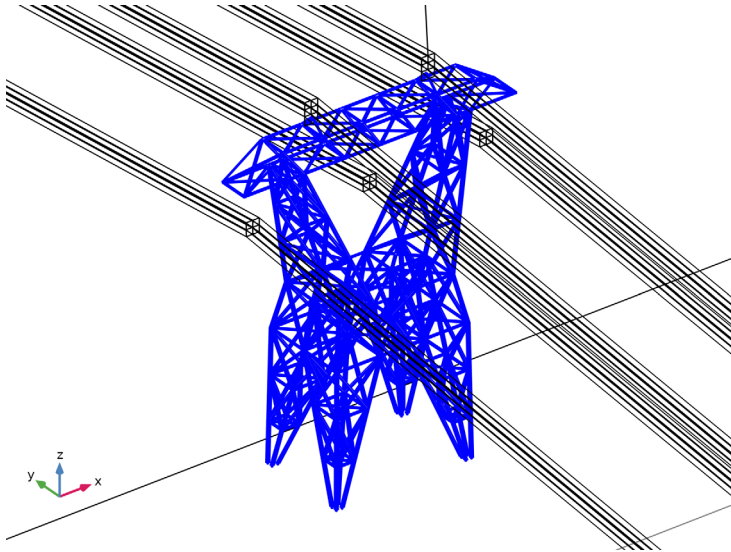

- 4 Click the  **Show More Options** button in the **Model Builder** toolbar.
- 5 In the **Show More Options** dialog, select **Physics** > **Equation Contributions** in the tree.
- 6 In the tree, select the checkbox for the node **Physics** > **Equation Contributions**.
- 7 Click **OK**.

#### *Pointwise Constraint 1*

- 1 In the **Physics** toolbar, click  **Edges** and choose **Pointwise Constraint**.
- 2 In the **Settings** window for **Pointwise Constraint**, locate the **Edge Selection** section.

- 3 From the **Selection** list, choose **All Wires**.

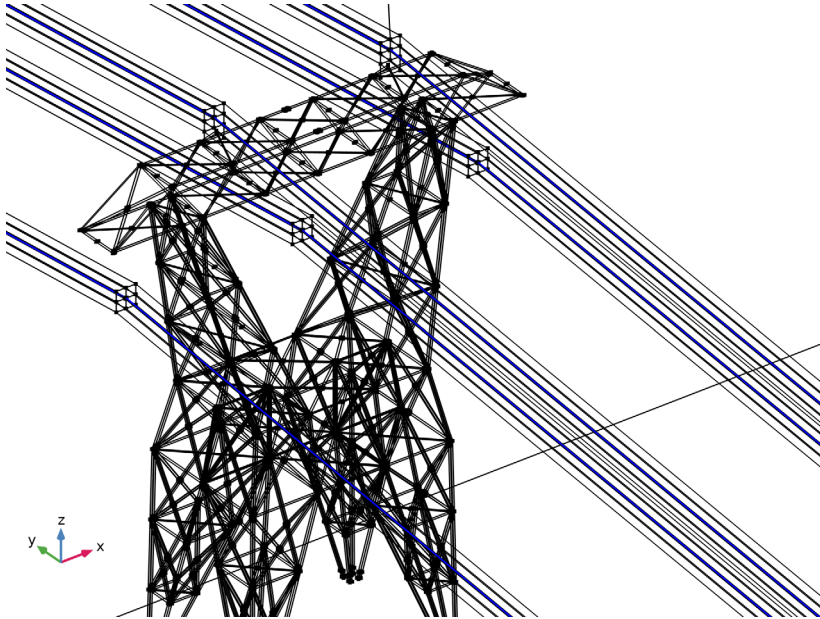

- 4 Locate the **Pointwise Constraint** section. In the **Constraint expression** text field, type  $0-tAx$ .

#### *Pointwise Constraint 2*

- 1 In the **Physics** toolbar, click  **Edges** and choose **Pointwise Constraint**.
- 2 In the **Settings** window for **Pointwise Constraint**, locate the **Edge Selection** section.
- 3 From the **Selection** list, choose **All Wires**.
- 4 Locate the **Pointwise Constraint** section. In the **Constraint expression** text field, type  $0-tAy$ .

#### *Pointwise Constraint 3*

- 1 In the **Physics** toolbar, click  **Edges** and choose **Pointwise Constraint**.
- 2 In the **Settings** window for **Pointwise Constraint**, locate the **Edge Selection** section.
- 3 From the **Selection** list, choose **All Wires**.
- 4 Locate the **Pointwise Constraint** section. In the **Constraint expression** text field, type  $0-tAz$ .

### Edge Current I

1 In the **Physics** toolbar, click  **Edges** and choose **Edge Current**.

**Edge Current** feature describes the behavior of a lightning strike.

2 In the **Settings** window for **Edge Current**, locate the **Edge Selection** section.

3 From the **Selection** list, choose **Lightning Channel**.

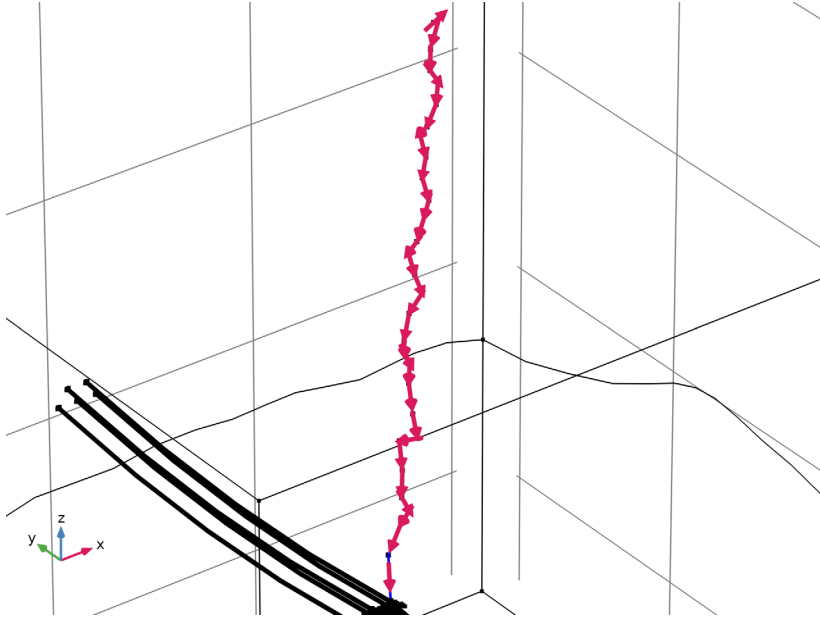

4 Locate the **Edge Current** section. From the **Edge current type** list, choose **Lightning**.

5 In the  $I_0$  text field, type 10[kA].

6 In the  $\tau_1$  text field, type 1[us].

7 In the  $\tau_2$  text field, type 60[us].

8 In the  $v_p$  text field, type c\_const/3.

9 Select the **Reverse direction** checkbox.

10 Click the **Plot Pulse Shape** button in the window toolbar.

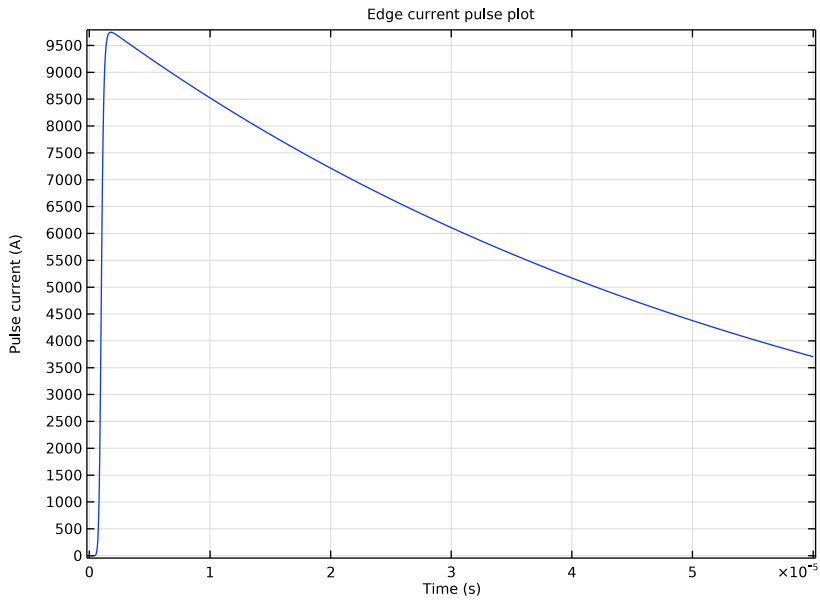

### *Perfect Electric Conductor 3*

- 1 In the **Physics** toolbar, click  **Boundaries** and choose **Perfect Electric Conductor**.
- 2 Select Boundaries 543, 545, 548, 671, 674, 1706, 1708, 1711, 1856, and 1859 only.  
You can also set the selection by copying the text '543, 545, 548, 671, 674, 1706,

1708, 1711, 1856, 1859’, clicking in the selection box, and then pressing **Ctrl+V**, or by using the **Paste Selection** dialog.

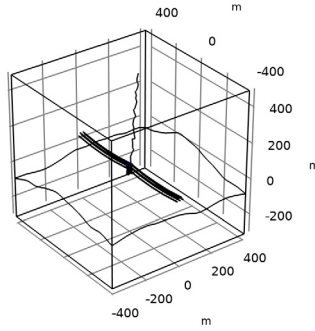

## MESH I

- 1 In the **Model Builder** window, under **Component 1 (comp1)** click **Mesh 1**.
- 2 In the **Settings** window for **Mesh**, locate the **Physics-Controlled Mesh** section.
- 3 In the table, clear the **Use** checkbox for **Geometric Analysis, Detail Size**.
- 4 Locate the **Electromagnetic Waves, Transient (temw)** section. In the **Maximum element size in free space** text field, type 200.
- 5 Locate the **Sequence Type** section. From the list, choose **User-controlled mesh**.

## Size

- 1 In the **Model Builder** window, under **Component 1 (comp1) > Mesh 1** click **Size**.
- 2 In the **Settings** window for **Size**, locate the **Element Size Parameters** section.
- 3 In the **Maximum element size** text field, type 100.
- 4 In the **Minimum element size** text field, type 15.

## Swept 1

- 1 In the **Mesh** toolbar, click  **Swept**.
- 2 In the **Settings** window for **Swept**, locate the **Domain Selection** section.
- 3 From the **Geometric entity level** list, choose **Domain**.

4 From the **Selection** list, choose **Phase Conductor**.

5 Drag and drop below **Size**.

#### *Swept 2*

1 Right-click **Swept 1** and choose **Duplicate**.

2 In the **Settings** window for **Swept**, locate the **Domain Selection** section.

3 From the **Selection** list, choose **Shielding Wire**.

4 In the **Graphics** window toolbar, click ▼ next to  **Select Domains**, then choose **Select Boundaries**.

5 Click the  **Click and Hide** button in the **Graphics** toolbar.

6 Select Boundary 7 only.

7 Select Boundary 4 only.

8 Select Boundary 5 only.

9 Click the  **Click and Hide** button in the **Graphics** toolbar.

#### *Free Tetrahedral 1*

1 In the **Model Builder** window, click **Free Tetrahedral 1**.

2 In the **Settings** window for **Free Tetrahedral**, click  **Build All**.

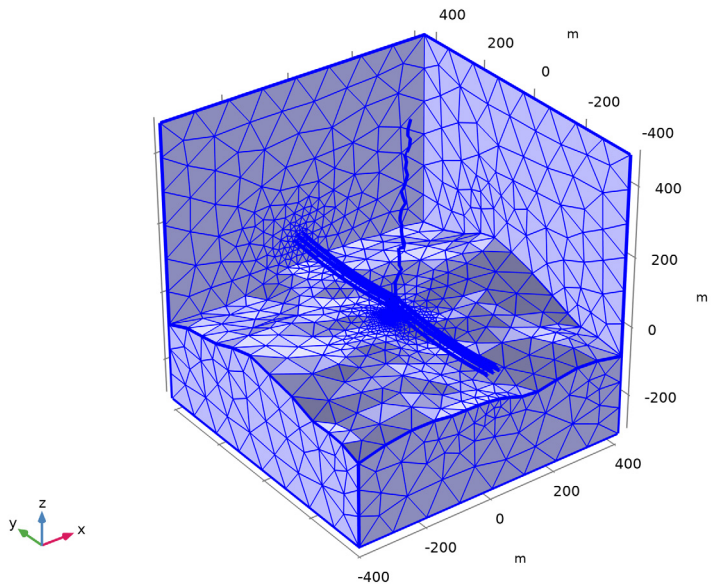



## STUDY 1

### Step 1: Time Dependent

- 1 In the **Model Builder** window, under **Study 1** click **Step 1: Time Dependent**.
- 2 In the **Settings** window for **Time Dependent**, locate the **Study Settings** section.
- 3 From the **Time unit** list, choose **μs**.
- 4 In the **Output times** text field, type range (0,0.05,6).

### Solution 1 (sol1)

- 1 In the **Study** toolbar, click  **Show Default Solver**.
- 2 In the **Model Builder** window, expand the **Solution 1 (sol1)** node, then click **Time-Dependent Solver 1**.
- 3 In the **Settings** window for **Time-Dependent Solver**, click to expand the **Time Stepping** section.
- 4 From the **Steps taken by solver** list, choose **Manual**.
- 5 In the **Time step** text field, type 0.02[us].
- 6 In the **Study** toolbar, click  **Compute**.

The TEMW interface is a purely A-formulation–based interface and is therefore limited to computing the induced voltage in closed loops resulting from gauge transformations (see, for example, [Ref. 1](#)). In general, this interface cannot be used to compute the induced voltage along an open curve, nor can it directly determine the voltage difference between two conductors, because the electric potential is not solved explicitly and is therefore not available within the formulation. In the present example, Cut Line Integration is employed as an approximation method, based on the assumption that the potential at the closest tower surface to the phase conductor is equal to the potential at the conductor center, thereby effectively forming a closed loop. From an engineering perspective, this assumption is generally acceptable, since practical interest typically lies in the induced voltage relative to the nearest grounded structure, which is the quantity governing electrical breakdown behavior and insulation design requirements.

## RESULTS

### Cut Line 3D 1

- 1 In the **Results** toolbar, click  **Cut Line 3D**.
- 2 In the **Settings** window for **Cut Line 3D**, locate the **Line Data** section.
- 3 In row **Point 1**, set **X** to -18.
- 4 In row **Point 1**, set **Z** to 40/3+23.

5 In row **Point 2**, set **X** to -18.

6 In row **Point 2**, set **Z** to 43.

#### *Cut Line 3D 2*

1 Right-click **Cut Line 3D 1** and choose **Duplicate**.

2 In the **Settings** window for **Cut Line 3D**, locate the **Line Data** section.

3 In row **Point 1**, set **X** to 0.

4 In row **Point 2**, set **X** to 0.

#### *Cut Line 3D 3*

1 Right-click **Cut Line 3D 2** and choose **Duplicate**.

2 In the **Settings** window for **Cut Line 3D**, locate the **Line Data** section.

3 In row **Point 1**, set **X** to 18.

4 In row **Point 2**, set **X** to 18.

#### *Line Integration 1*

1 In the **Results** toolbar, click  $\frac{8.85}{e-12}$  **More Derived Values** and choose **Integration > Line Integration**.

2 In the **Settings** window for **Line Integration**, locate the **Data** section.

3 From the **Dataset** list, choose **Cut Line 3D 1**.

4 Locate the **Expressions** section. In the table, enter the following settings:

Expression	Unit	Description
temw.Ez	kV	Induced Voltage Phase A

5 Click  **Evaluate**.

#### *Line Integration 2*

1 Right-click **Line Integration 1** and choose **Duplicate**.

2 In the **Settings** window for **Line Integration**, locate the **Data** section.

3 From the **Dataset** list, choose **Cut Line 3D 2**.

4 Locate the **Expressions** section. In the table, enter the following settings:

Expression	Unit	Description
temw.Ez	kV	Induced Voltage Phase B

5 Click  **Evaluate**.

### Line Integration 3

- 1 Right-click **Line Integration 2** and choose **Duplicate**.
- 2 In the **Settings** window for **Line Integration**, locate the **Data** section.
- 3 From the **Dataset** list, choose **Cut Line 3D 3**.
- 4 Locate the **Expressions** section. In the table, enter the following settings:

Expression	Unit	Description
temw.Ez	kV	Induced Voltage Phase C

- 5 Click  **Evaluate**.

### ID Plot Group 2

In the **Results** toolbar, click  **ID Plot Group**.

### Table Graph 1

- 1 Right-click **ID Plot Group 2** and choose **Table Graph**.
- 2 In the **Settings** window for **Table Graph**, click to expand the **Legends** section.
- 3 Select the **Show legends** checkbox.

### ID Plot Group 2

- 1 In the **Model Builder** window, click **ID Plot Group 2**.
- 2 In the **Settings** window for **ID Plot Group**, locate the **Plot Settings** section.
- 3 Select the **y-axis label** checkbox. In the associated text field, type **Induced Voltage (kV)**.
- 4 Locate the **Legend** section. From the **Position** list, choose **Lower right**.

5 In the **ID Plot Group 2** toolbar, click  **Plot**.

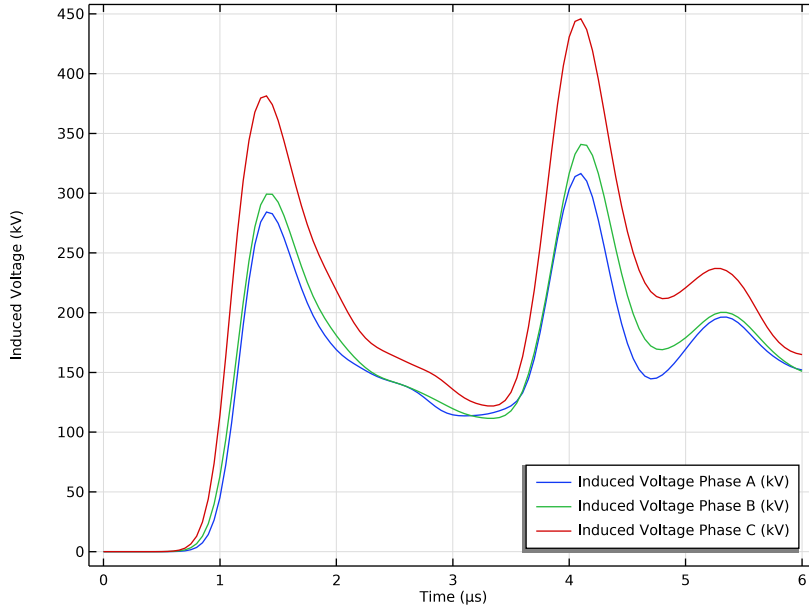

The subsequent instructions will guide you on enhancing the default plot through visualization effects.

### *Multislice 1*

- 1 In the **Model Builder** window, expand the **Results > 3D Plot Group 1** node, then click **Multislice 1**.
- 2 In the **Settings** window for **Multislice**, locate the **Expression** section.
- 3 In the **Expression** text field, type `t*emw.Ez`.
- 4 Locate the **Multipane Data** section. Find the **Y-planes** subsection. In the **Planes** text field, type `0`.
- 5 Find the **Z-planes** subsection. In the **Planes** text field, type `0`.
- 6 Click to expand the **Range** section. Select the **Manual color range** checkbox.
- 7 In the **Minimum** text field, type `-10000`.
- 8 In the **Maximum** text field, type `10000`.
- 9 Locate the **Coloring and Style** section. From the **Color table** list, choose **ThermalWaveDark**.

### *Transparency I*

- 1 Right-click **Multislice I** and choose **Transparency**.
- 2 In the **Settings** window for **Transparency**, locate the **Transparency** section.
- 3 Find the **Transparency** subsection. Set the **Transparency** value to **0.85**.

### *Line I*

- 1 In the **Model Builder** window, right-click **3D Plot Group I** and choose **Line**.
- 2 In the **Settings** window for **Line**, locate the **Coloring and Style** section.
- 3 From the **Line type** list, choose **Tube**.
- 4 In the **Tube radius expression** text field, type  $z/40$ .
- 5 Select the **Radius scale factor** checkbox.
- 6 From the **Color table** list, choose **ThermalLightClassic**.
- 7 From the **Scale** list, choose **Logarithmic**.

### *Transparency I*

- 1 Right-click **Line I** and choose **Transparency**.
- 2 In the **Settings** window for **Transparency**, locate the **Transparency** section.
- 3 Find the **Transparency** subsection. Set the **Transparency** value to **0.85**.

### *Selection I*

- 1 In the **Model Builder** window, right-click **Line I** and choose **Selection**.
- 2 In the **Settings** window for **Selection**, locate the **Selection** section.
- 3 From the **Selection** list, choose **Lightning Channel**.

### *Volume I*

- 1 In the **Model Builder** window, right-click **3D Plot Group I** and choose **Volume**.
- 2 In the **Settings** window for **Volume**, locate the **Coloring and Style** section.
- 3 From the **Color table** list, choose **GaiLight**.
- 4 From the **Scale** list, choose **Logarithmic**.

### *Selection I*

- 1 Right-click **Volume I** and choose **Selection**.
- 2 Select Domain 1 only.

### *Material Appearance I*

- 1 In the **Model Builder** window, right-click **Volume I** and choose **Material Appearance**.
- 2 In the **Settings** window for **Material Appearance**, locate the **Appearance** section.

- 3 From the **Appearance** list, choose **Custom**.
- 4 From the **Material type** list, choose **Soil**.
- 5 Locate the **Color** section. Select the **Use the plot's color** checkbox.

#### *Volume 2*

- 1 In the **Model Builder** window, right-click **3D Plot Group 1** and choose **Volume**.
- 2 In the **Settings** window for **Volume**, locate the **Coloring and Style** section.
- 3 From the **Color table** list, choose **Dipole**.
- 4 From the **Scale** list, choose **Logarithmic**.

#### *Selection 1*

- 1 Right-click **Volume 2** and choose **Selection**.
- 2 In the **Settings** window for **Selection**, locate the **Selection** section.
- 3 From the **Selection** list, choose **Phase Conductor**.

#### *Transparency 1*

- 1 In the **Model Builder** window, right-click **Volume 2** and choose **Transparency**.
- 2 In the **Settings** window for **Transparency**, locate the **Transparency** section.
- 3 Find the **Transparency** subsection. Set the **Transparency** value to **0.75**.

#### *Volume 3*

Right-click **Volume 2** and choose **Duplicate**.

#### *Selection 1*

- 1 In the **Model Builder** window, expand the **Volume 3** node, then click **Selection 1**.
- 2 In the **Settings** window for **Selection**, locate the **Selection** section.
- 3 From the **Selection** list, choose **Shielding Wire**.

#### *Surface 1*

In the **Model Builder** window, right-click **3D Plot Group 1** and choose **Surface**.

#### *Selection 1*

- 1 In the **Model Builder** window, right-click **Surface 1** and choose **Selection**.
- 2 In the **Settings** window for **Selection**, locate the **Selection** section.
- 3 From the **Selection** list, choose **Tower**.

#### *Line 2*

- 1 In the **Model Builder** window, right-click **3D Plot Group 1** and choose **Line**.
- 2 In the **Settings** window for **Line**, locate the **Expression** section.

- 3 In the **Expression** text field, type 1.
- 4 Locate the **Coloring and Style** section. From the **Line type** list, choose **Tube**.
- 5 Select the **Radius scale factor** checkbox. In the associated text field, type 0.3.

#### *Selection 1*

- 1 Right-click **Line 2** and choose **Selection**.
- 2 In the **Settings** window for **Selection**, locate the **Selection** section.
- 3 From the **Selection** list, choose **Lightning Channel**.

#### *Material Appearance 1*

- 1 In the **Model Builder** window, right-click **Line 2** and choose **Material Appearance**.
- 2 In the **Settings** window for **Material Appearance**, locate the **Appearance** section.
- 3 From the **Appearance** list, choose **Custom**.
- 4 From the **Material type** list, choose **Gold**.

#### *Line 3*

- 1 In the **Model Builder** window, right-click **3D Plot Group 1** and choose **Line**.
- 2 In the **Settings** window for **Line**, locate the **Expression** section.
- 3 In the **Expression** text field, type 1.
- 4 Locate the **Coloring and Style** section. From the **Line type** list, choose **Tube**.
- 5 Select the **Radius scale factor** checkbox. In the associated text field, type 0.3.
- 6 From the **Coloring** list, choose **Uniform**.
- 7 From the **Color** list, choose **Black**.

#### *Selection 1*

- 1 Right-click **Line 3** and choose **Selection**.
- 2 In the **Settings** window for **Selection**, locate the **Selection** section.
- 3 From the **Selection** list, choose **All Wires**.
- 4 In the **3D Plot Group 1** toolbar, click  **Plot**.

#### *3D Plot Group 1*

- 1 In the **Model Builder** window, under **Results** click **3D Plot Group 1**.
- 2 In the **Settings** window for **3D Plot Group**, locate the **Data** section.
- 3 From the **Time ( $\mu$ s)** list, choose 5.
- 4 Click to expand the **Title** section. From the **Title type** list, choose **None**.
- 5 Locate the **Plot Settings** section. Clear the **Plot dataset edges** checkbox.

6 Locate the **Color Legend** section. Clear the **Show legends** checkbox.

7 In the **3D Plot Group I** toolbar, click  **Plot**.

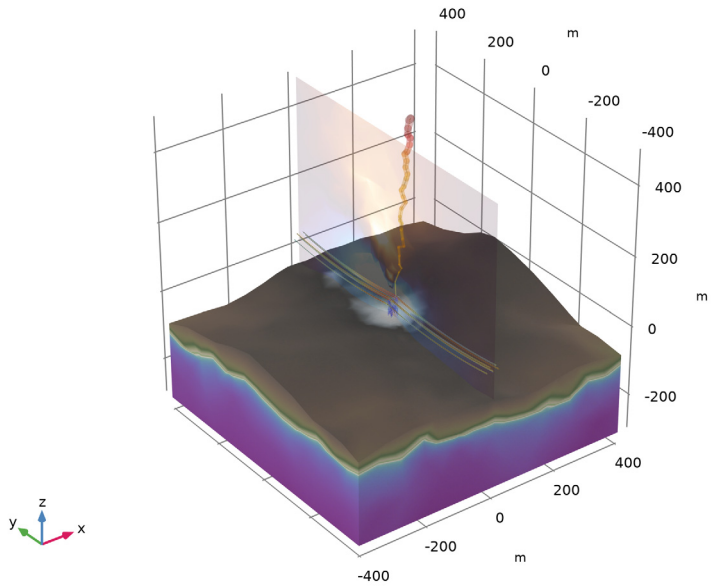

By adjusting the 3D camera settings, the plot can be made even more visually striking.

## DEFINITIONS

### Camera

- 1 In the **Model Builder** window, expand the **View I** node, then click **Camera**.
- 2 In the **Settings** window for **Camera**, locate the **Camera** section.
- 3 In the **Zoom angle** text field, type 50.
- 4 Locate the **Position** section. In the **x** text field, type -130.
- 5 In the **y** text field, type -100.
- 6 In the **z** text field, type 35.
- 7 Locate the **Target** section. In the **x** text field, type 5000.
- 8 In the **y** text field, type 4500.
- 9 In the **z** text field, type 200.
- 10 Locate the **Up Vector** section. In the **x** text field, type 0.
- 11 In the **y** text field, type 0.

- 12 In the **z** text field, type 1.
- 13 Locate the **Center of Rotation** section. In the **x** text field, type -20.
- 14 In the **y** text field, type -18.
- 15 In the **z** text field, type 34.
- 16 Locate the **View Offset** section. In the **x** text field, type -0.09.
- 17 In the **y** text field, type 0.00.
- 18 Click  **Update**.

## RESULTS

### 3D Plot Group 1

In the **Model Builder** window, under **Results** click **3D Plot Group 1**.

