



Model created in COMSOL Multiphysics 6.4

# Dipole Antenna

## Introduction

---

The dipole antenna is one of the most straightforward antenna configurations. It can be realized with two thin metallic rods that have a sinusoidal voltage difference applied between them. The length of the rods is chosen such that they are quarter wavelength elements at the operating frequency. Such an antenna has a well-known torus-like radiation pattern.

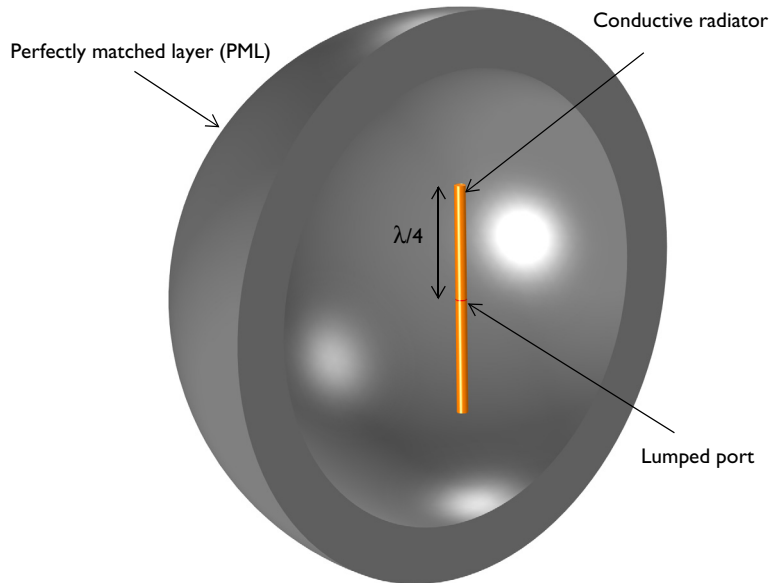

*Figure 1: A dipole antenna. The model consists of two cylindrical arms of conductive material with a voltage source in between. A region of free space bounded by a perfectly matched layer (PML) surrounds the antenna.*

## Model Definition

---

The model of the antenna consists of two cylinders representing each of the dipole arms. The free space wavelength at the antenna's operating frequency is 4 m. Thus, each of the antenna arms is 1 m long and aligned with the  $z$ -axis. The arm radius is chosen to be 0.05 m. In the limit as the radius approaches zero, this antenna approaches the analytic solution for a thin linear half wave dipole antenna.

A small cylindrical gap of size 0.01 m between the antenna arms represents the voltage source. The power supply and feed structure are not modeled explicitly, and it is assumed

that a uniform voltage difference is applied across these faces. This source induces electromagnetic fields and surface currents on the adjacent conductive faces.

The dipole arm surfaces are modeled using the Impedance Boundary Condition, which is appropriate for conductive surfaces that have dimensions much larger than the skin depth. This boundary condition introduces a finite conductivity at the surface as well as resistive losses.

The air domain around the antenna is modeled as sphere of free space of radius 2 m, which is approximately the boundary between the near-field and the far-field. This sphere of air is truncated with a perfectly matched layer (PML) that acts as an absorber of outgoing radiation. The far-field pattern is computed on the boundary between the air and the PML domains.

The mesh is manually adjusted such that there are five elements per free space wavelength and that the boundaries of the antenna are meshed more finely. The PML is swept with a total of five elements along the radial direction.

### *Results and Discussion*

---

The magnitude of the electric field around the antenna is shown in [Figure 2](#). The fields appear artificially high near the excitation, as well as at the ends of the arms. These peaks in the intensity are due to local singularities; the fields at sharp transitions in the model are locally artificially high, but they do not affect the results some distance (1~2 elements) away from these regions.

The polar plot in [Figure 3](#) of the far-field pattern in the  $xy$ -plane shows the expected isotropic radiation pattern. The 3D visualization of the far-field intensity in [Figure 4](#) shows the expected torus-shaped pattern.

The real part of the impedance as seen by the port is evaluated to be about  $120 \Omega$ , which agrees reasonably with expectations. With further tuning of the antenna length, radius, and gap height to have the resonance at which the reactance is zero, the result approaches the well known value for a half-wave ( $0.48\lambda_0$ ) dipole antenna, which is  $73 \Omega$ .

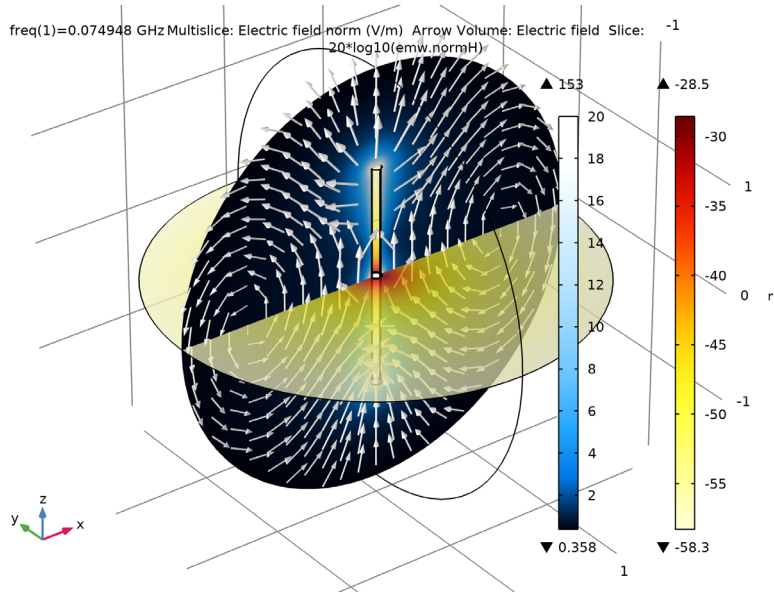

Figure 2: A slice plot of the electric and magnetic field magnitude around the antenna.

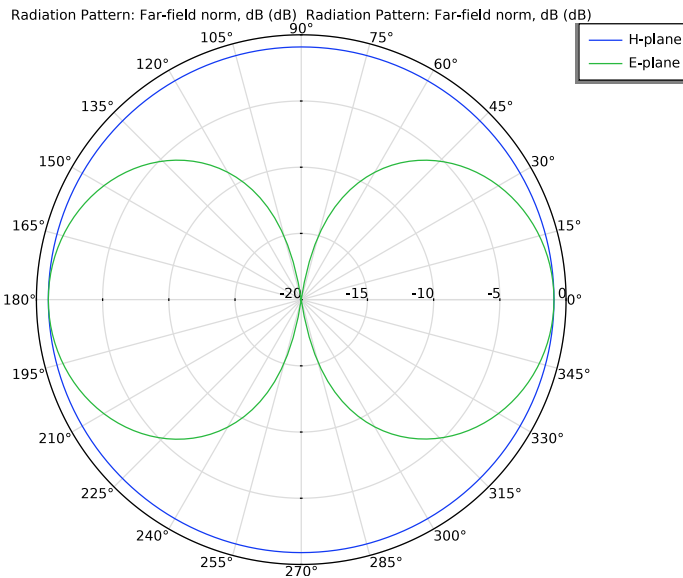

Figure 3: The polar plot of the far field pattern in the xy-plane is isotropic.

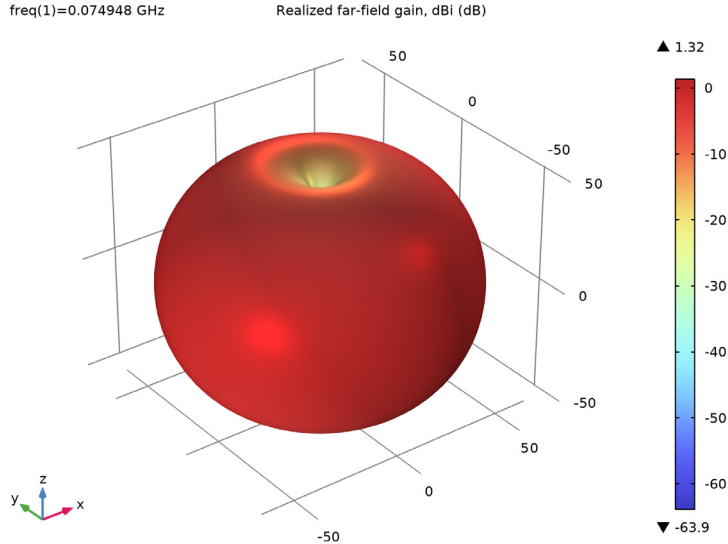

Figure 4: A 3D visualization of the far-field pattern of the dipole shows the expected torus-shaped pattern.

---

**Application Library path:** RF\_Module/Antennas/dipole\_antenna

---

### *Modeling Instructions*



---

From the **File** menu, choose **New**.

#### **NEW**

In the **New** window, click  **Model Wizard**.

#### **MODEL WIZARD**

- 1 In the **Model Wizard** window, click  **3D**.
- 2 In the **Select Physics** tree, select **Radio Frequency > Electromagnetic Waves, Frequency Domain (emw)**.
- 3 Click **Add**.
- 4 Click  **Study**.

5 In the **Select Study** tree, select **General Studies > Frequency Domain**.

6 Click  **Done**.

## GLOBAL DEFINITIONS

### Parameters 1

1 In the **Model Builder** window, under **Global Definitions** click **Parameters 1**.

2 In the **Settings** window for **Parameters**, locate the **Parameters** section.

3 In the table, enter the following settings:

Name	Expression	Value	Description
lda0	4[m]	4 m	Operating wavelength
arm_length	lda0/4	1 m	Dipole antenna arm length
r_antenna	arm_length/20	0.05 m	Dipole antenna arm radius
gap_size	arm_length/100	0.01 m	Gap between arms

## STUDY 1

### Step 1: Frequency Domain

Define the study frequency ahead of performing any frequency-dependent operation such as building mesh. The physics-controlled mesh uses the specified frequency value.

1 In the **Model Builder** window, under **Study 1** click **Step 1: Frequency Domain**.

2 In the **Settings** window for **Frequency Domain**, locate the **Study Settings** section.

3 In the **Frequencies** text field, type  $c\_const/lda0$ .

## GEOMETRY 1

Create a sphere with a layer. The outer layer presents the PML.

### Sphere 1 (sph1)

1 In the **Geometry** toolbar, click  **Sphere**.

2 In the **Settings** window for **Sphere**, locate the **Size** section.

3 In the **Radius** text field, type  $2.4*arm\_length$ .

4 Click to expand the **Layers** section. In the table, enter the following settings:

Layer name	Thickness (m)
Layer 1	$0.5*arm\_length$

5 Click  **Build Selected**.

Choose wireframe rendering to get a better view of the interior parts.

6 Click the  **Wireframe Rendering** button in the **Graphics** toolbar.

Add a cylinder with layers. The top and bottom parts are the antenna radiators. A small gap between the antenna radiators is for the voltage source.

*Cylinder 1 (cyl1)*

1 In the **Geometry** toolbar, click  **Cylinder**.

2 In the **Settings** window for **Cylinder**, locate the **Size and Shape** section.

3 In the **Radius** text field, type `r_antenna`.

4 In the **Height** text field, type `2*arm_length+gap_size`.

5 Locate the **Position** section. In the **z** text field, type `-(arm_length+gap_size/2)`.

6 Click to expand the **Layers** section. In the table, enter the following settings:

Layer name	Thickness (m)
Layer 1	<code>arm_length</code>

7 Clear the **Layers on side** checkbox.

8 Select the **Layers on bottom** checkbox.

9 Select the **Layers on top** checkbox.

10 Click  **Build All Objects**.

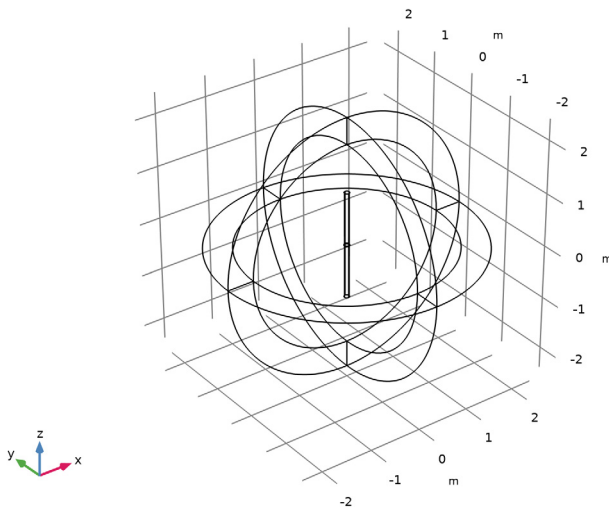

## DEFINITIONS

Add a perfectly matched layer on the outermost domain of the sphere.

*Perfectly Matched Layer 1 (pml1)*

- 1 In the **Definitions** toolbar, click  **Perfectly Matched Layer**.
- 2 Select Domains 1–4 and 9–12 only.
- 3 In the **Settings** window for **Perfectly Matched Layer**, locate the **Geometry** section.
- 4 From the **Type** list, choose **Spherical**.

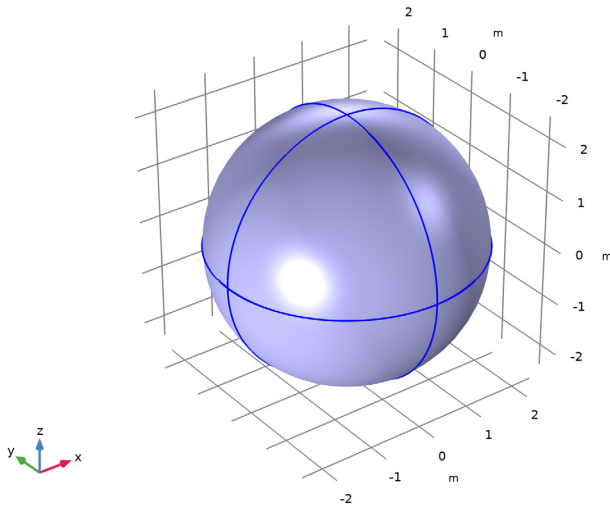

*View 1*

Suppress some domains and boundaries. This helps to see the interior parts when setting up the physics and reviewing the mesh.

*Hide for Physics 1*

- 1 In the **Model Builder** window, right-click **View 1** and choose **Hide for Physics**.

2 Select Domains 1 and 2 only.

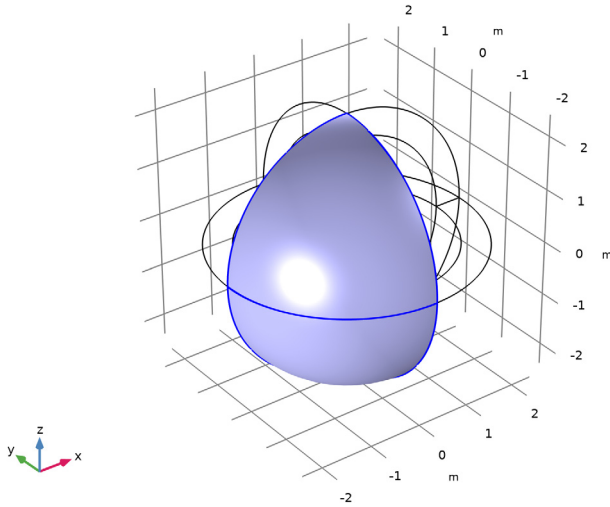

*Hide for Physics 2*

- 1 Right-click **View 1** and choose **Hide for Physics**.
- 2 In the **Settings** window for **Hide for Physics**, locate the **Geometric Entity Selection** section.
- 3 From the **Geometric entity level** list, choose **Boundary**.

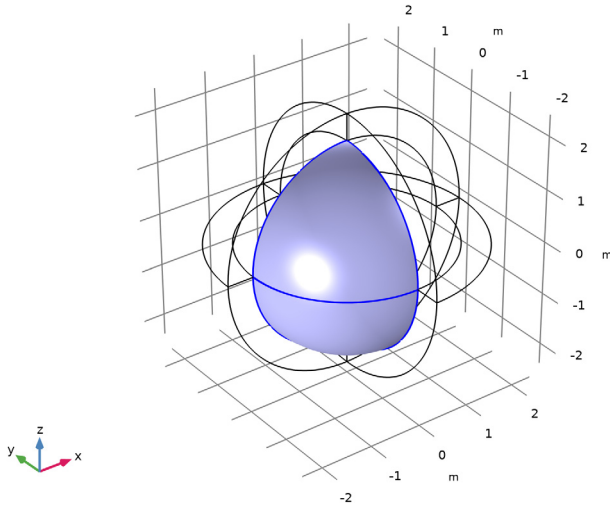

4 Select Boundaries 9 and 10 only.



## MATERIALS

Assign air as the material for all domains and override the antenna radiator surface with copper.

### ADD MATERIAL

- 1 In the **Materials** toolbar, click  **Add Material** to open the **Add Material** window.
- 2 Go to the **Add Material** window.
- 3 In the tree, select **Built-in > Air**.
- 4 Click the **Add to Component** button in the window toolbar.
- 5 In the tree, select **Built-in > Copper**.
- 6 Click the **Add to Component** button in the window toolbar.
- 7 In the **Materials** toolbar, click  **Add Material** to close the **Add Material** window.

## MATERIALS

*Copper (mat2)*

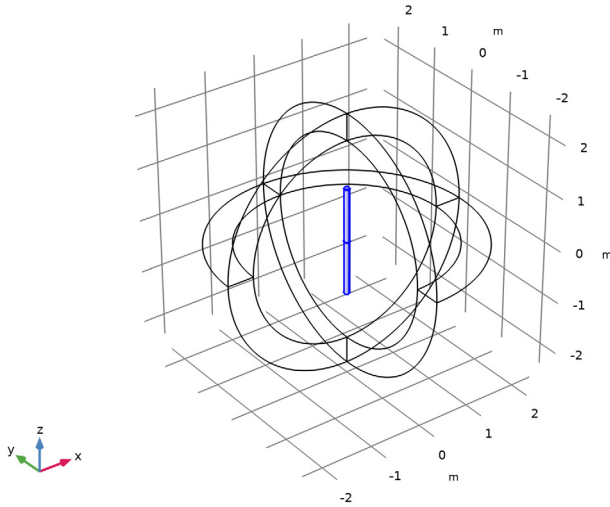

- 1 In the **Settings** window for **Material**, locate the **Geometric Entity Selection** section.
- 2 From the **Geometric entity level** list, choose **Domain**.

3 Select Domains 6 and 8 only.



## ELECTROMAGNETIC WAVES, FREQUENCY DOMAIN (EMW)

### Lumped Port 1

- 1 In the **Physics** toolbar, click  **Boundaries** and choose **Lumped Port**.
- 2 Click the  **Zoom In** button in the **Graphics** toolbar, a couple of times to see the small gap between antenna radiators clearly.

3 Select Boundaries 16, 17, 31, and 42 only.

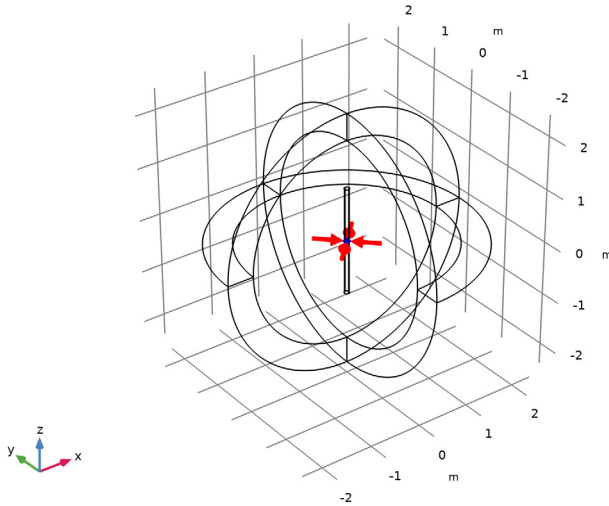

4 In the **Settings** window for **Lumped Port**, locate the **Lumped Port Properties** section.

5 From the **Type of lumped port** list, choose **User defined**.

6 In the  $h_{\text{port}}$  text field, type `gap_size`.

7 In the  $w_{\text{port}}$  text field, type `2*pi*r_antenna`.

8 Specify the  $\mathbf{a}_h$  vector as

0	x
0	y
1	z

For the first port, wave excitation is **on** by default.

## ELECTROMAGNETIC WAVES, FREQUENCY DOMAIN (EMW)

Next, to set up the physics quickly, use the toolbar button at the top of the physics interface's **Settings** window.

1 In the **Model Builder** window, under **Component 1 (comp1)** click **Electromagnetic Waves, Frequency Domain (emw)**.

2 In the **Settings** window for **Electromagnetic Waves, Frequency Domain**, click the **Lossy Features from Materials** button in the window toolbar. This tool automatically generates or updates lossy features, including impedance boundary, domain impedance

boundary, or transition boundary conditions, adjusting the selection based on material definitions, geometry size, and skin depth.

### *Impedance Boundary Condition 1*

1 Click the  **Zoom Extents** button in the **Graphics** toolbar.

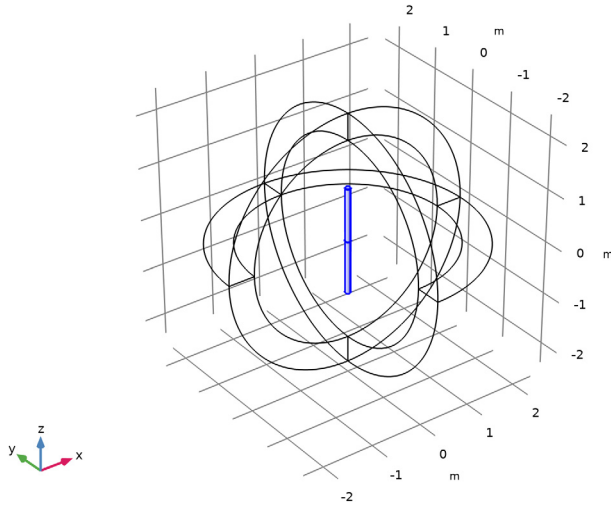

2 Click the  **Zoom Extents** button in the **Graphics** toolbar.

### *Far-Field Domain 1*

In the **Physics** toolbar, click  **Domains** and choose **Far-Field Domain**.

## MESH 1

In the **Model Builder** window, under **Component 1 (comp1)** right-click **Mesh 1** and choose **Build All**.

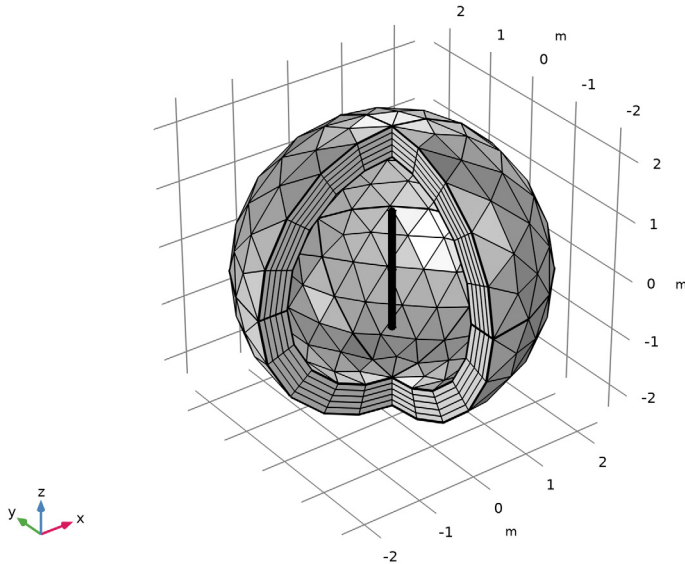

## STUDY 1



In the **Study** toolbar, click  **Compute**.

## RESULTS

The default plot shows the E-field norm, the 2D far field in a polar plot, and the 3D far-field radiation pattern.

### *Multislice 1*

- 1 In the **Model Builder** window, expand the **Results > Electric Field (emw)** node, then click **Multislice 1**.
- 2 In the **Settings** window for **Multislice**, locate the **Multipane Data** section.
- 3 Find the **X-planes** subsection. In the **Planes** text field, type 0.
- 4 Find the **Z-planes** subsection. In the **Planes** text field, type 0.
- 5 Click to expand the **Range** section. Select the **Manual color range** checkbox.
- 6 In the **Maximum** text field, type 20.

- 7 Locate the **Coloring and Style** section. From the **Color table** list, choose **JupiterAuroraBorealis**.
- 8 In the **Electric Field (emw)** toolbar, click  **Plot**.
- 9 Click the  **Zoom In** button in the **Graphics** toolbar.

#### *Arrow Volume I*

- 1 In the **Model Builder** window, right-click **Electric Field (emw)** and choose **Arrow Volume**.
- 2 In the **Settings** window for **Arrow Volume**, locate the **Arrow Positioning** section.
- 3 Find the **X grid points** subsection. In the **Points** text field, type 21.
- 4 Find the **Y grid points** subsection. In the **Points** text field, type 1.
- 5 Find the **Z grid points** subsection. In the **Points** text field, type 21.
- 6 Locate the **Coloring and Style** section. From the **Arrow length** list, choose **Logarithmic**.
- 7 In the **Range quotient** text field, type 3000.
- 8 From the **Color** list, choose **White**.

#### *Slice I*

- 1 Right-click **Electric Field (emw)** and choose **Slice**.
- 2 In the **Settings** window for **Slice**, locate the **Expression** section.
- 3 In the **Expression** text field, type  $20 * \log_{10}(emw.normH)$ .
- 4 Locate the **Plane Data** section. From the **Plane** list, choose **XY-planes**.
- 5 In the **Planes** text field, type 1.
- 6 Locate the **Coloring and Style** section. From the **Color table** list, choose **Thermal**.
- 7 From the **Color table transformation** list, choose **Reverse**.

#### *Transparency I*

- 1 Right-click **Slice I** and choose **Transparency**.
- 2 In the **Settings** window for **Transparency**, locate the **Transparency** section.
- 3 Find the **Transparency** subsection. Set the **Transparency** value to **0.25**.

#### *Electric Field (emw)*

- 1 In the **Model Builder** window, under **Results** click **Electric Field (emw)**.
- 2 In the **Settings** window for **3D Plot Group**, click to expand the **Selection** section.
- 3 From the **Geometric entity level** list, choose **Domain**.
- 4 Select Domain 5 only.
- 5 Select the **Apply to dataset edges** checkbox.

6 In the **Electric Field (emw)** toolbar, click  **Plot**.

The results show the E-field norm and dB-scaled magnetic field norm distribution around the antenna radiators. It is plotted in [Figure 2](#).

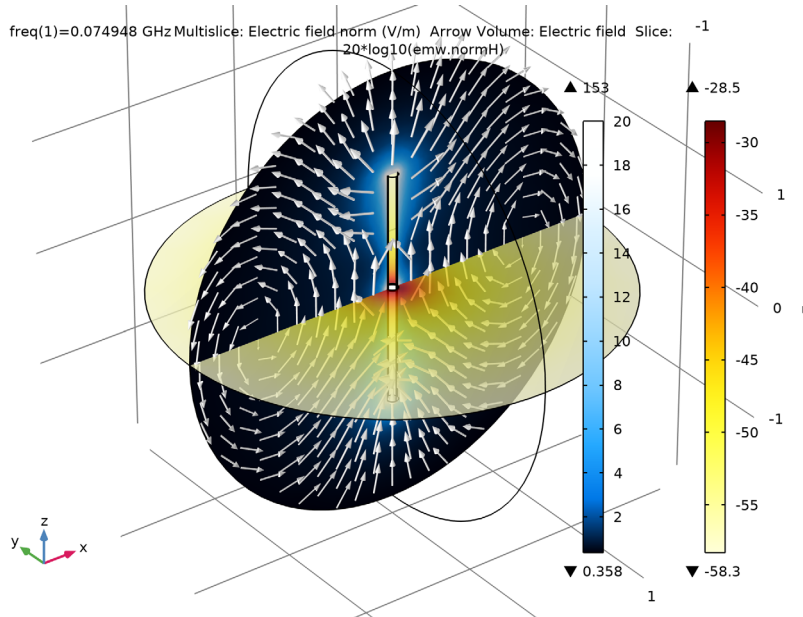

### Electric Field, Logarithmic (emw)

In the **Model Builder** window, click **Electric Field, Logarithmic (emw)**.

freq(1)=0.074948 GHz Surface: 1 (1) Multislice: Electric field norm (V/m) Surface: Electric field norm (V/m)

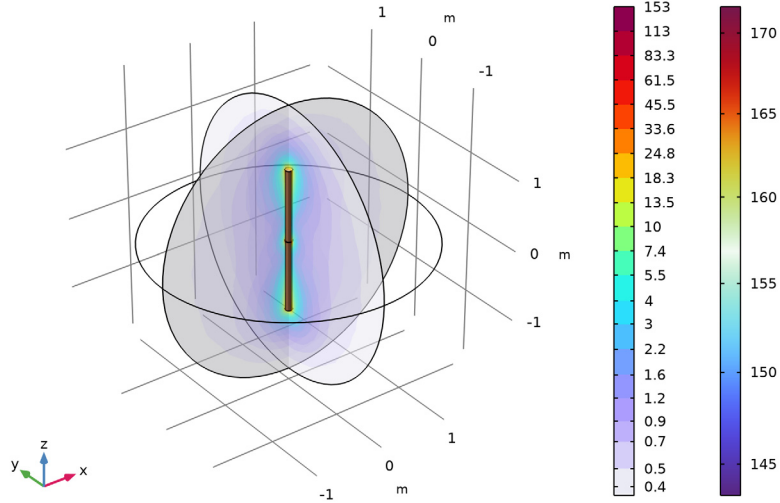

### 2D Far Field (emw)

Adjust the axis range.

- 1 In the **Model Builder** window, click **2D Far Field (emw)**.
- 2 In the **Settings** window for **Polar Plot Group**, locate the **Axis** section.
- 3 Select the **Manual axis limits** checkbox.
- 4 In the **r minimum** text field, type -20.
- 5 In the **r maximum** text field, type 0.

### Radiation Pattern 1

- 1 In the **Model Builder** window, expand the **2D Far Field (emw)** node, then click **Radiation Pattern 1**.
- 2 In the **Settings** window for **Radiation Pattern**, locate the **Expression** section.
- 3 In the **Expression** text field, type `emw.normdBefar`.
- 4 Click to expand the **Legends** section. From the **Legends** list, choose **Manual**.

5 In the table, enter the following settings:

---

**Legends**

H-plane

---

6 In the **2D Far Field (emw)** toolbar, click  **Plot**.

The plotted H-plane pattern is omnidirectional (isotropic) on the  $xy$ -plane as shown in [Figure 3](#). The E- and H-plane of a linearly polarized antenna are defined by the antenna main polarization. The E-plane includes the main polarization that is  $E_z$  in this model while the H-plane is perpendicular to the main polarization.

*Radiation Pattern 2*

1 Right-click **Results > 2D Far Field (emw) > Radiation Pattern 1** and choose **Duplicate**.

2 In the **Settings** window for **Radiation Pattern**, locate the **Evaluation** section.

3 Find the **Normal vector** subsection. In the **y** text field, type 1.

4 In the **z** text field, type 0.

5 Find the **Angles** subsection. From the **Compute beamwidth** list, choose **On**.

6 In the **Level down** text field, type 3.

With these settings, the beamwidth is calculated according to the given level-down value.

7 Locate the **Legends** section. In the table, enter the following settings:

---

**Legends**

E-plane

---

8 In the **2D Far Field (emw)** toolbar, click  **Plot**.

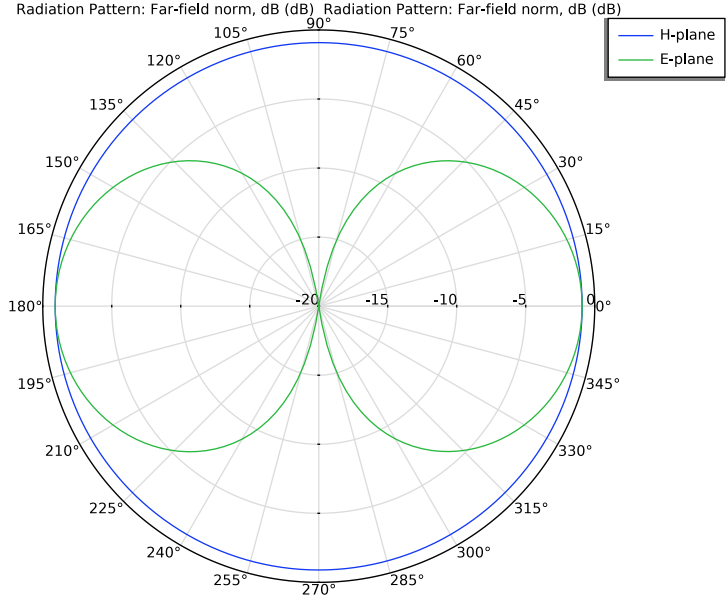

The computed half-power beamwidth is about 75.5 degrees. Note that the result is valid only when the main beam for calculation is at 0 degree in the plot. The beam orientation in the plot can be adjusted by setting the **Normal vector** and **Reference direction**.

### 3D Far Field, Gain (emw)

1 In the **Model Builder** window, under **Results** click **3D Far Field, Gain (emw)**.

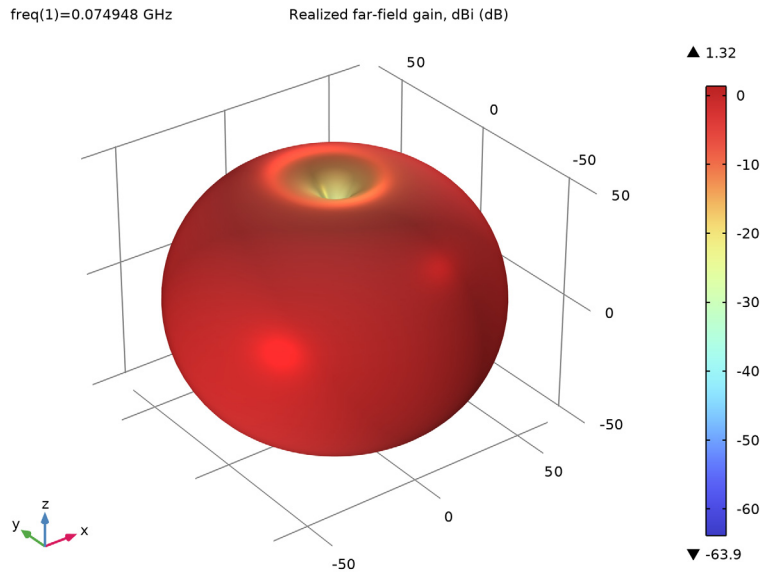

Compare the reproduced plot with [Figure 4](#).

Evaluate the port impedance.

### Global Evaluation 2

1 In the **Results** toolbar, click  **Global Evaluation**.

2 In the **Settings** window for **Global Evaluation**, click **Replace Expression** in the upper-right corner of the **Expressions** section. From the menu, choose **Component 1 (comp1) > Electromagnetic Waves, Frequency Domain > Ports > emw.Zport\_1 - Lumped port 1 impedance -  $\Omega$** .

3 Click  **Evaluate**.

### 3D Plot Group 6

In the **Results** toolbar, click  **3D Plot Group**.

### Isosurface 1

1 Right-click **3D Plot Group 6** and choose **Isosurface**.

2 In the **Settings** window for **Isosurface**, locate the **Expression** section.

3 In the **Expression** text field, type  $20 \cdot \log_{10}(\text{emw.normE})$ .

- 4 Locate the **Levels** section. In the **Total levels** text field, type 15.
- 5 Locate the **Coloring and Style** section. From the **Color table** list, choose **HeatCamera**.
- 6 From the **Color table transformation** list, choose **Reverse**.

#### Filter 1

- 1 Right-click **Isosurface 1** and choose **Filter**.
- 2 In the **Settings** window for **Filter**, locate the **Element Selection** section.
- 3 In the **Logical expression for inclusion** text field, type  $y > 0$ .

#### Selection 1

- 1 In the **Model Builder** window, right-click **Isosurface 1** and choose **Selection**.
- 2 Select Domain 5 only.
- 3 In the **3D Plot Group 6** toolbar, click  **Plot**.

#### 3D Plot Group 6

- 1 In the **Model Builder** window, under **Results** click **3D Plot Group 6**.
- 2 In the **Settings** window for **3D Plot Group 6**, locate the **Plot Settings** section.
- 3 Clear the **Plot dataset edges** checkbox.
- 4 In the **3D Plot Group 6** toolbar, click  **Plot**.

