



Model created in COMSOL Multiphysics 6.4

# Biconical Antenna

## Introduction

---

The biconical antenna is a wideband antenna with an omnidirectional radiation pattern. This example models such an antenna, including its coaxial feed structure.

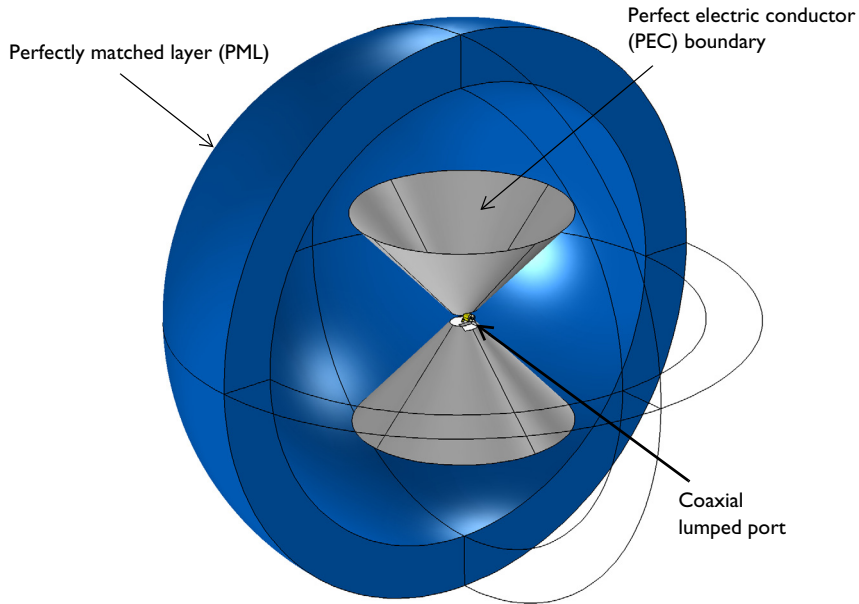

*Figure 1: Biconical antenna fed by a coaxial lumped port. The region of free space around the antenna is truncated by a perfectly matched layer (PML).*

## Model Definition

---

The biconical antenna, shown in [Figure 1](#), is composed of two conical, metallic, radiating elements. [Figure 2](#) shows the details of the feed structure at the center. A short section of a dielectric-filled coaxial cable starts at a small cylindrical domain containing the power source, which is not part of the model domain. Instead, you model the source by applying a coaxial lumped port condition at the boundary facing the coaxial cable, which launches a wave down the coax. The inner and outer conductors of the coax are connected to the cone-shaped radiators via wires that you model as perfect electric conductors. A small symmetric cutout in each cone provides sufficient clearance for mounting and assembly.

The distance between radiators and the surface area of the cone end tips controls the reactance of the antenna's input port, and can be adjusted to alter antenna performance.

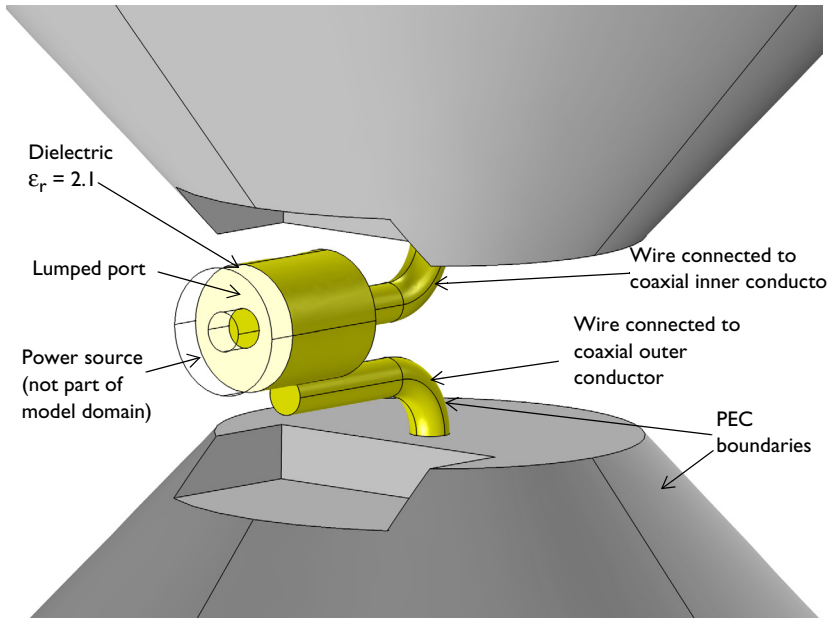

*Figure 2: The zoomed view of the coaxial lumped port. The coaxial cable begins at a small cylindrical domain that is external to the model domain, as are the wire interiors.*

### *Results and Discussion*

---

The simulated results in [Figure 3](#) shows that  $S_{11}$  is less than  $-10$  dB from 1.5 GHz to 3.5 GHz. This is much wider than a typical dipole antenna bandwidth. The radiation pattern at the E-plane and the H-plane resembles that from a dipole antenna. The biconical antenna works well in applications requiring an omnidirectional radiation pattern and a wide bandwidth.

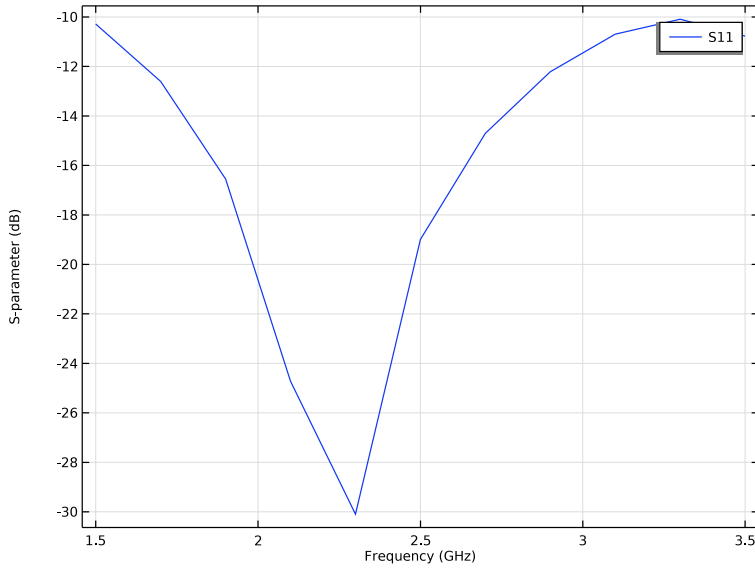

Figure 3: The frequency response of the biconical antenna shows wideband impedance matching.

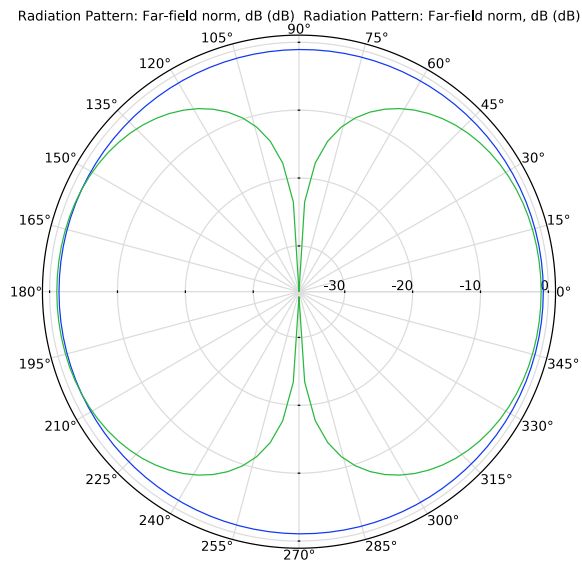

Figure 4: Far-field radiation pattern at the E-plane (blue) and the H-plane (green) at 1.9 GHz. It is similar to the radiation pattern of a dipole antenna.

## References

---

1. D.M. Pozar, *Microwave Engineering*, John Wiley & Sons, 1998.
  2. C.A. Balanis, *Antenna Theory*, John Wiley & Sons, 1997.
  3. R.E. Collin, *Antennas and Radiowave Propagation*, McGraw Hill, 1985.
- 

**Application Library path:** RF\_Module/Antennas/biconical\_antenna

---

## Modeling Instructions



---

From the **File** menu, choose **New**.

### NEW

In the **New** window, click  **Model Wizard**.

### MODEL WIZARD

- 1 In the **Model Wizard** window, click  **3D**.
- 2 In the **Select Physics** tree, select **Radio Frequency > Electromagnetic Waves, Frequency Domain (emw)**.
- 3 Click **Add**.
- 4 Click  **Study**.
- 5 In the **Select Study** tree, select **General Studies > Frequency Domain**.
- 6 Click  **Done**.

### STUDY I

#### *Step 1: Frequency Domain*

Define the study frequency ahead of performing any frequency-dependent operation such as building mesh. The physics-controlled mesh uses the highest frequency value in the specified range.



- 1 In the **Model Builder** window, under **Study I** click **Step 1: Frequency Domain**.
- 2 In the **Settings** window for **Frequency Domain**, locate the **Study Settings** section.
- 3 In the **Frequencies** text field, type range (1.5[GHz], 0.2[GHz], 3.5[GHz]).

## GEOMETRY 1

- 1 In the **Model Builder** window, under **Component 1 (comp1)** click **Geometry 1**.
- 2 In the **Settings** window for **Geometry**, locate the **Units** section.
- 3 From the **Length unit** list, choose **mm**.

Add a cylinder for the inner conductor.

### *Cylinder 1 (cyl1)*

- 1 In the **Geometry** toolbar, click  **Cylinder**.
- 2 In the **Settings** window for **Cylinder**, locate the **Size and Shape** section.
- 3 In the **Radius** text field, type 0.635.
- 4 In the **Height** text field, type 7.95.
- 5 Locate the **Position** section. In the **x** text field, type -10.
- 6 In the **z** text field, type 1.2.
- 7 Locate the **Axis** section. From the **Axis type** list, choose **x-axis**.
- 8 Click  **Build Selected**.
- 9 Click the  **Wireframe Rendering** button in the **Graphics** toolbar.

Add a concentric cylinder to include the outer conductor.

### *Cylinder 2 (cyl2)*

- 1 In the **Geometry** toolbar, click  **Cylinder**.
- 2 In the **Settings** window for **Cylinder**, locate the **Size and Shape** section.
- 3 In the **Radius** text field, type 2.05.
- 4 In the **Height** text field, type 6.
- 5 Locate the **Position** section. In the **x** text field, type -10.
- 6 In the **z** text field, type 1.2.
- 7 Locate the **Axis** section. From the **Axis type** list, choose **x-axis**.
- 8 Click to expand the **Layers** section. In the table, enter the following settings:



Layer name	Thickness (mm)
Layer 1	1

- 9 Clear the **Layers on side** checkbox.
- 10 Select the **Layers on bottom** checkbox.
- 11 Click  **Build Selected**.

12 Click the  **Zoom Extents** button in the **Graphics** toolbar.



Next, create a structure connecting the coaxial cable and the radiator.

#### *Torus 1 (tor1)*

- 1 In the **Geometry** toolbar, click  **Torus**.
- 2 In the **Settings** window for **Torus**, locate the **Size and Shape** section.
- 3 In the **Major radius** text field, type 2.05.
- 4 In the **Minor radius** text field, type 0.635.
- 5 In the **Revolution angle** text field, type 90.
- 6 Locate the **Position** section. In the **x** text field, type -2.05.
- 7 In the **z** text field, type 2.25+1.
- 8 Locate the **Axis** section. From the **Axis type** list, choose **Cartesian**.
- 9 In the **y** text field, type 1.
- 10 In the **z** text field, type 0.
- 11 Locate the **Rotation Angle** section. In the **Rotation** text field, type 270.
- 12 Click  **Build Selected**.

Create a domain backing the lumped port. This part is excluded from the model space later on.

#### *Cylinder 3 (cyl3)*

- 1 In the **Geometry** toolbar, click  **Cylinder**.
- 2 In the **Settings** window for **Cylinder**, locate the **Size and Shape** section.
- 3 In the **Radius** text field, type 0.635.
- 4 In the **Height** text field, type 4.95.
- 5 Locate the **Position** section. In the **x** text field, type -7.
- 6 In the **z** text field, type -1.2.
- 7 Locate the **Axis** section. From the **Axis type** list, choose **Cartesian**.
- 8 In the **x** text field, type 1.
- 9 In the **z** text field, type 0.
- 10 Click  **Build Selected**.

Go on to add a radiator cone.



#### *Cone 1 (cone1)*

- 1 In the **Geometry** toolbar, click  **Cone**.



- 2 In the **Settings** window for **Cone**, locate the **Size and Shape** section.
- 3 In the **Bottom radius** text field, type 51.
- 4 In the **Height** text field, type 51.
- 5 From the **Specify top size using** list, choose **Angle**.
- 6 In the **Semiangle** text field, type 40.
- 7 Locate the **Position** section. In the **z** text field, type 54.25.
- 8 Locate the **Axis** section. From the **Axis type** list, choose **Cartesian**.
- 9 In the **z** text field, type -1.
- 10 Click  **Build Selected**.

Add a block representing the assembly and mounting cutout from the upper radiator.

#### *Block 1 (blk1)*

- 1 In the **Geometry** toolbar, click  **Block**.
- 2 In the **Settings** window for **Block**, locate the **Size and Shape** section.
- 3 In the **Width** text field, type 8.
- 4 In the **Depth** text field, type 9.
- 5 In the **Height** text field, type 3.
- 6 Locate the **Position** section. In the **x** text field, type -10.
- 7 In the **y** text field, type -4.5.
- 8 In the **z** text field, type 2.
- 9 Click  **Build Selected**.

#### *Difference 1 (dif1)*

- 1 In the **Geometry** toolbar, click  **Booleans and Partitions** and choose **Difference**.
- 2 Select the object **cone1** only.
- 3 In the **Settings** window for **Difference**, locate the **Difference** section.
- 4 Click to select the  **Activate Selection** toggle button for **Objects to subtract**.
- 5 Select the object **blk1** only.
- 6 Click  **Build Selected**.

Generate the second radiator by mirroring the first one.

#### *Mirror 1 (mir1)*



- 1 In the **Geometry** toolbar, click  **Transforms** and choose **Mirror**.
- 2 Select the objects **dif1** and **tor1** only.

- 3 In the **Settings** window for **Mirror**, locate the **Input** section.
- 4 Select the **Keep input objects** checkbox.
- 5 Click  **Build Selected**.

#### *Sphere 1 (sph1)*

- 1 In the **Geometry** toolbar, click  **Sphere**.
- 2 In the **Settings** window for **Sphere**, locate the **Size** section.
- 3 In the **Radius** text field, type 150.
- 4 Click to expand the **Layers** section. In the table, enter the following settings:

Layer name	Thickness (mm)
Layer 1	40

- 5 Click  **Build All Objects**.
- 6 Click the  **Go to Default View** button in the **Graphics** toolbar.  
Disable the analysis of the geometry as the remaining small geometric details can be kept.
- 7 In the **Model Builder** window, click **Geometry 1**.
- 8 In the **Settings** window for **Geometry**, locate the **Cleanup** section.
- 9 Clear the **Automatic detection of small details** checkbox.
- 10 In the **Geometry** toolbar, click  **Build All**.

## DEFINITIONS

### *External Domains*

- 1 In the **Definitions** toolbar, click  **Explicit**.  
Next, create a set of selections for use when setting up the physics.
- 2 In the **Settings** window for **Explicit**, type External Domains in the **Label** text field.

**3** Select Domains 8, 9, 11, 12, and 14–16 only.

You can do this most easily by copying the text '8, 9, 11, 12, and 14-16', clicking in the selection box, and then pressing **Ctrl+V**, or by using the **Paste Selection** dialog.

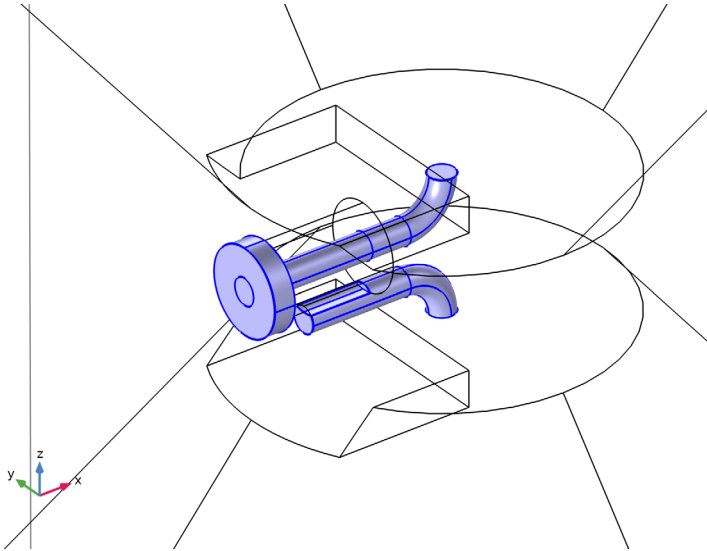

**4** Click the  **Go to Default View** button in the **Graphics** toolbar.

#### *Model Domains*

**1** In the **Definitions** toolbar, click  **Complement**.

**2** In the **Settings** window for **Complement**, type Model Domains in the **Label** text field.

**3** Locate the **Input Entities** section. Under **Selections to invert**, click  **Add**.

**4** In the **Add** dialog, select **External Domains** in the **Selections to invert** list.

5 Click **OK**.

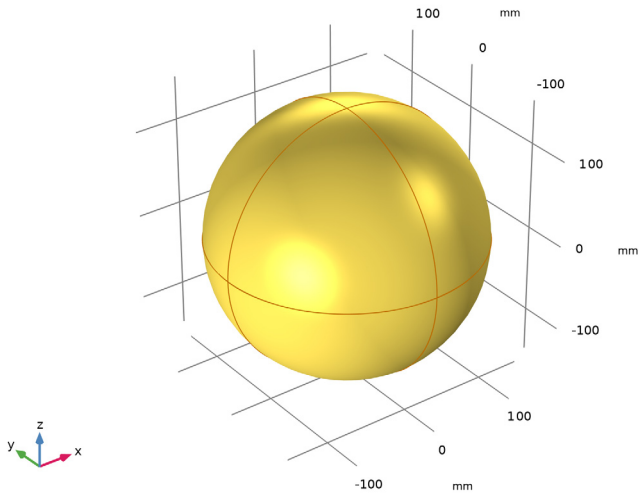

#### *Internal PEC Boundaries*

- 1 In the **Definitions** toolbar, click  **Explicit**.
- 2 In the **Settings** window for **Explicit**, type Internal PEC Boundaries in the **Label** text field.
- 3 Locate the **Input Entities** section. From the **Geometric entity level** list, choose **Boundary**.
- 4 Select Boundaries 13, 14, 16, 17, 29, 30, 32, 33, 37, 40–44, 55, 56, 74, 75, 85, 86, 95, and 96 only.

- 5 Click the  **Zoom In** button in the **Graphics** toolbar, a couple of times to see the selected boundaries clearly.

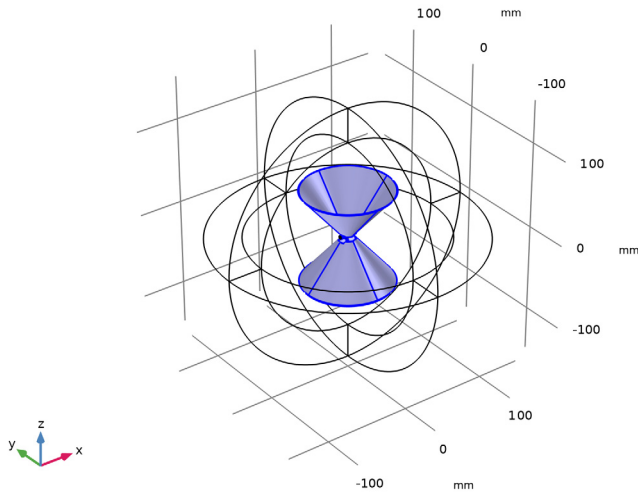

#### *Perfectly Matched Layer 1 (pml1)*

- 1 In the **Definitions** toolbar, click  **Perfectly Matched Layer**.
- 2 Select Domains 1–4 and 17–20 only.
- 3 In the **Settings** window for **Perfectly Matched Layer**, locate the **Geometry** section.
- 4 From the **Type** list, choose **Spherical**.

Hide some domains to get a better view of the interior parts.

#### *Hide for Physics 1*

- 1 In the **Model Builder** window, right-click **View 1** and choose **Hide for Physics**.
- 2 Select Domains 1, 2, 5, 17, and 18 only.

### **ELECTROMAGNETIC WAVES, FREQUENCY DOMAIN (EMW)**

- 1 In the **Model Builder** window, under **Component 1 (comp1)** click **Electromagnetic Waves, Frequency Domain (emw)**.
- 2 In the **Settings** window for **Electromagnetic Waves, Frequency Domain**, locate the **Domain Selection** section.
- 3 From the **Selection** list, choose **Model Domains**.

### Perfect Electric Conductor 2

- 1 In the **Physics** toolbar, click  **Boundaries** and choose **Perfect Electric Conductor**.
- 2 In the **Settings** window for **Perfect Electric Conductor**, locate the **Boundary Selection** section.
- 3 From the **Selection** list, choose **Internal PEC Boundaries**.

While the perfect electric conductor is the default boundary condition for exterior boundaries, you need to apply this condition explicitly to interior boundaries.

### Lumped Port 1

- 1 In the **Physics** toolbar, click  **Boundaries** and choose **Lumped Port**.
- 2 Select Boundary 31 only.

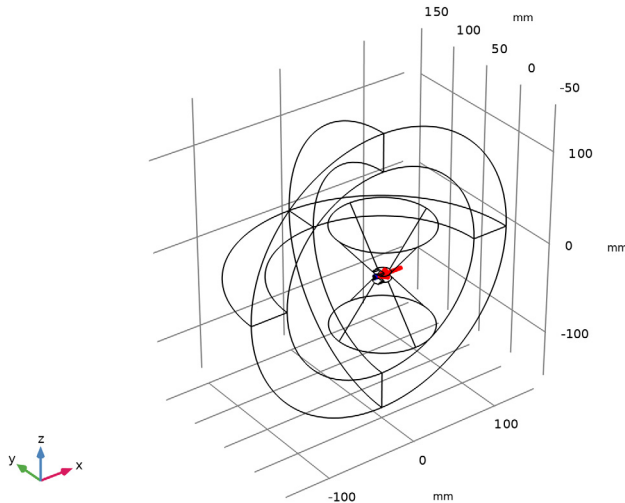

- 3 In the **Settings** window for **Lumped Port**, locate the **Lumped Port Properties** section.
- 4 From the **Type of lumped port** list, choose **Coaxial**.

For the first port, wave excitation is **on** by default.

### Far-Field Domain 1

In the **Physics** toolbar, click  **Domains** and choose **Far-Field Domain**.

### ADD MATERIAL

- 1 In the **Materials** toolbar, click  **Add Material** to open the **Add Material** window.
- 2 Go to the **Add Material** window.

- 3 In the tree, select **Built-in > Air**.
- 4 Click the **Add to Component** button in the window toolbar.
- 5 In the **Materials** toolbar, click  **Add Material** to close the **Add Material** window.

## MATERIALS

*Air (mat1)*

Override this material for the coaxial cable domain.

*PTFE*

- 1 In the **Model Builder** window, right-click **Materials** and choose **Blank Material**.
- 2 In the **Settings** window for **Material**, type PTFE in the **Label** text field.
- 3 Select Domain 10 only.
- 4 Locate the **Material Contents** section. In the table, enter the following settings:

Property	Variable	Value	Unit	Property group
Relative permittivity	epsilon <sub>nr_ii</sub> ; epsilon <sub>nr_ii</sub> = epsilon <sub>nr_ii</sub> , epsilon <sub>nr_ij</sub> = 0	2.1		Basic
Relative permeability	mu <sub>r_ii</sub> ; mu <sub>r_ii</sub> = mu <sub>r_ii</sub> , mu <sub>r_ij</sub> = 0	1		Basic
Electric conductivity	sigma <sub>iso</sub> ; sigma <sub>ii</sub> = sigma <sub>iso</sub> , sigma <sub>ij</sub> = 0	0	S/m	Basic

## MESH 1

- 1 In the **Model Builder** window, under **Component 1 (comp1)** right-click **Mesh 1** and choose **Build All**.
- 2 Click the  **Zoom Extents** button in the **Graphics** toolbar.

- 3 Click the  **Zoom In** button in the **Graphics** toolbar.

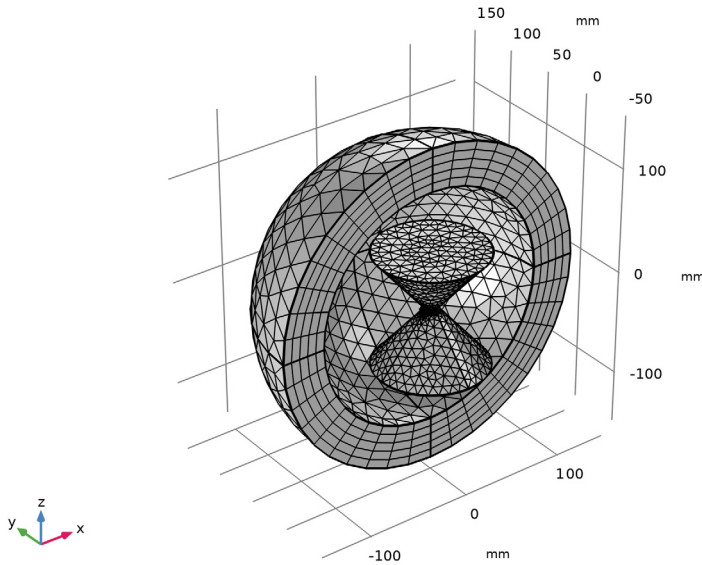

- 4 Click the  **Reset Hiding** button in the **Graphics** toolbar, to reset the visibility state of the hidden domains in preparation of the results processing.

## STUDY I

In the **Study** toolbar, click  **Compute**.

## RESULTS

### *Electric Field (emw)*

Begin the results analysis and visualization by modifying the first default plot to show the E-field norm in the  $xz$ -plane.

### *Multislice I*

- 1 In the **Model Builder** window, expand the **Electric Field (emw)** node, then click **Multislice I**.
- 2 In the **Settings** window for **Multislice**, locate the **Expression** section.
- 3 In the **Expression** text field, type  $20 \cdot \log_{10}(\text{emw}.\text{normE})$ .
- 4 Select the **Description** checkbox. In the associated text field, type **Electric field norm (dB)**.

- 5 Locate the **Multiplane Data** section. Find the **Z-planes** subsection. In the **Planes** text field, type 0.
- 6 Find the **X-planes** subsection. In the **Planes** text field, type 0.
- 7 Click to expand the **Range** section. Select the **Manual color range** checkbox.
- 8 In the **Minimum** text field, type -60.
- 9 In the **Maximum** text field, type 60.
- 10 In the **Electric Field (emw)** toolbar, click  **Plot**.

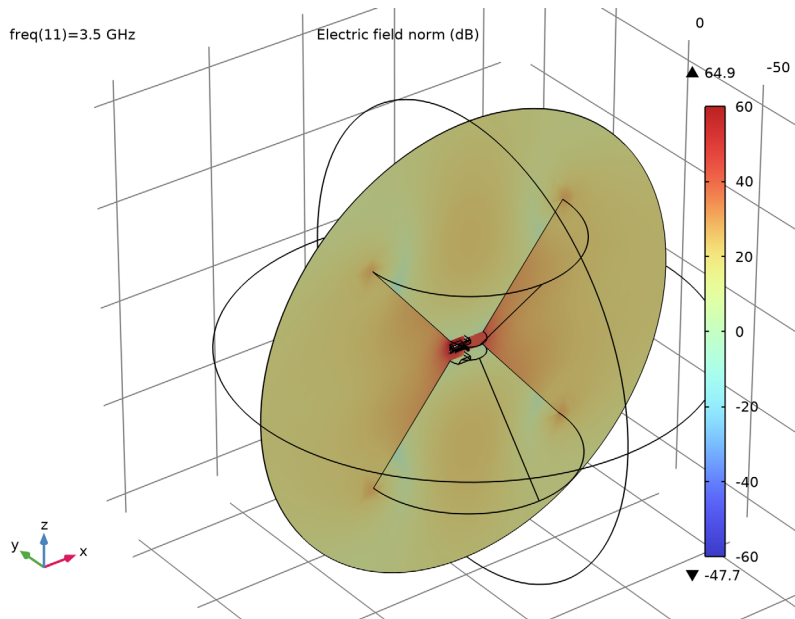

Use the zoom controls in the **Graphics** toolbar to explore the plot further.  
 The following instructions reproduce the frequency-response plot shown in [Figure 3](#).

### Smith Plot (emw)

- 1 In the **Model Builder** window, click **Smith Plot (emw)**.

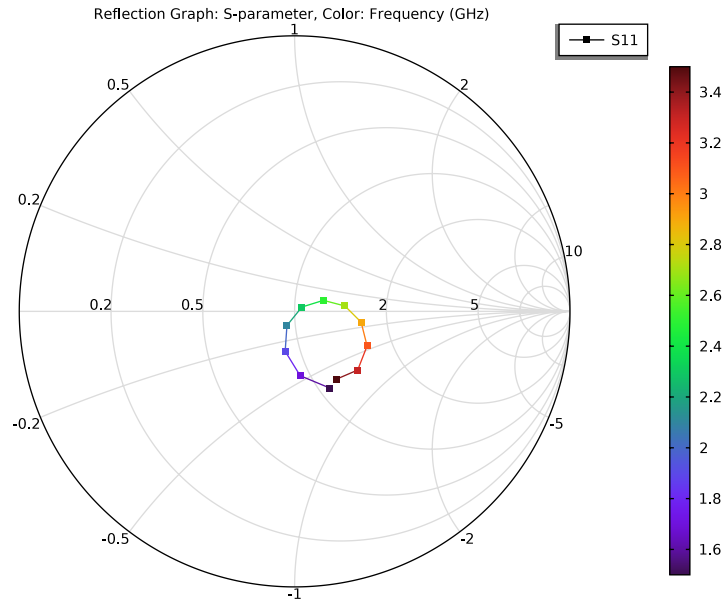

- 2 Click the  **Zoom Out** button in the **Graphics** toolbar.

### Multislice 1

- 1 In the **Model Builder** window, expand the **Results > Electric Field, Logarithmic (emw)** node, then click **Multislice 1**.
- 2 In the **Settings** window for **Multislice**, locate the **Expression** section.
- 3 In the **Expression** text field, type `emw.normE+1e1`.

The multislice plot uses a logarithmic scale. When the solutions include values very close to zero, the dynamic range of the data becomes too wide to visualize properly, while the meaningful data range occupies only a small fraction of it. To improve plot quality, a small negligible noise can be added.

4 In the **Electric Field, Logarithmic (emw)** toolbar, click  **Plot**.

freq(11)=3.5 GHz Surface: 1 (1) Surface: 1 (1) Multislice: emw.normE+1e1 (V/m) Surface: Electric field norm (V/m) Surface: Electric field norm (V/m)

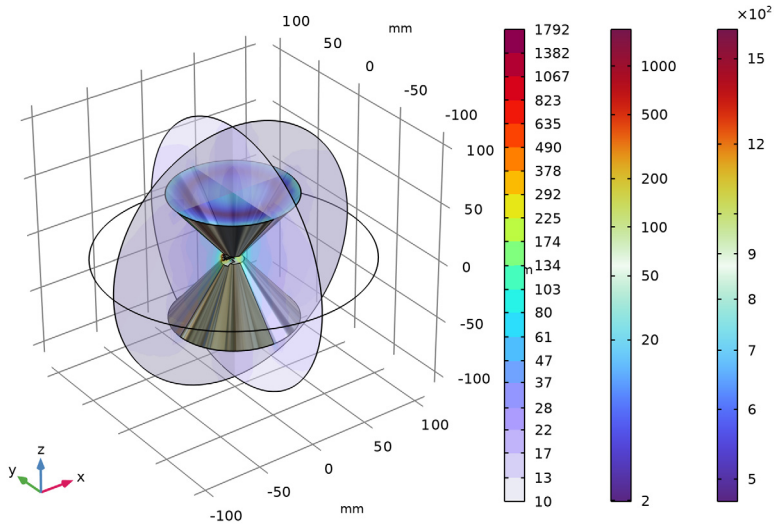

*3D Far Field, Gain (emw)*

- 1 In the **Model Builder** window, under **Results** click **3D Far Field, Gain (emw)**.
- 2 In the **Settings** window for **3D Plot Group**, locate the **Data** section.
- 3 From the **Parameter value (freq (GHz))** list, choose **1.5**.

4 In the **3D Far Field, Gain (emw)** toolbar, click  **Plot**.

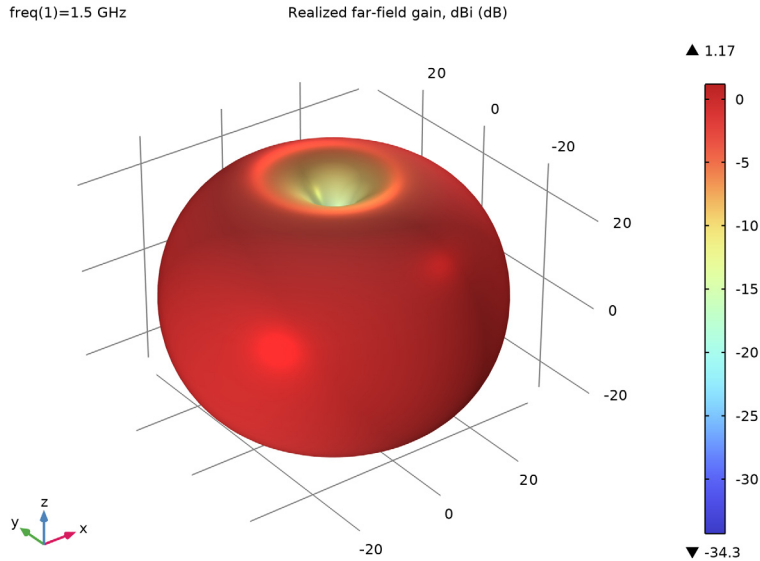

3D far-field pattern is isotropic on the  $xy$ -plane.

Finally, reproduce the polar plot of the far-field on the E- and H-plane.

#### *Polar Plot Group 8*

- 1 In the **Results** toolbar, click  **Polar Plot Group**.
- 2 In the **Settings** window for **Polar Plot Group**, locate the **Data** section.
- 3 From the **Parameter selection (freq)** list, choose **From list**.
- 4 In the **Parameter values (freq (GHz))** list box, select **1.9**.

#### *Radiation Pattern 1*

- 1 In the **Polar Plot Group 8** toolbar, click  **More Plots** and choose **Radiation Pattern**.
- 2 In the **Settings** window for **Radiation Pattern**, click **Replace Expression** in the upper-right corner of the **Expression** section. From the menu, choose **Component I (comp1) > Electromagnetic Waves, Frequency Domain > Far field > emw.normdBefar - Far-field norm, dB - dB**.
- 3 Locate the **Evaluation** section. Find the **Angles** subsection. In the **Number of angles** text field, type 100.

*Radiation Pattern 2*

- 1 Right-click **Radiation Pattern 1** and choose **Duplicate**.
  - 2 In the **Settings** window for **Radiation Pattern**, locate the **Evaluation** section.
  - 3 Find the **Normal vector** subsection. In the **x** text field, type 1.
  - 4 In the **z** text field, type 0.
  - 5 Find the **Reference direction** subsection. In the **x** text field, type 0.
  - 6 In the **y** text field, type 1.
  - 7 In the **Polar Plot Group 8** toolbar, click  **Plot**.
- Compare the resulting plot with that shown in [Figure 4](#).