



Model created in COMSOL Multiphysics 6.4

# Insulation of a Pipeline Section

## *Introduction*

---

As oil flows through a pipeline, heat is dissipated due to internal viscous shear in the fluid. With good insulation of the pipeline, this generated heat can be used to avoid the need of preheating of the oil, despite the fact that it needs to be transported in a cold environment over long distances.

This model uses the Nonisothermal Pipe Flow interface to set up and solve the flow and energy equations describing oil transport in a pipeline section. With the addition of an Optimization study, the thickness of the pipeline insulation can be found such that the temperature is constant along the pipe stretch.

---

**Note:** The third study in this application requires the Optimization Module.

---

## *Model Definition*

---

Oil flowing at a rate of  $2500 \text{ m}^3/\text{h}$  enters a 150 km pipeline section with a temperature of  $25^\circ\text{C}$ . The average temperature outside of the pipeline is  $-10^\circ\text{C}$ .



*Figure 1: A section of pipeline transporting crude oil.*

## FLOW EQUATIONS

The continuity and momentum equations below describe the flow of oil inside a horizontal pipe:

$$\begin{aligned}\nabla \cdot (A\rho\mathbf{u}) &= 0 \\ 0 &= -\nabla p - f_D \frac{\rho}{2d_h} \mathbf{u}|\mathbf{u}|\end{aligned}\quad (1)$$

Above,  $A$  (SI unit:  $\text{m}^2$ ) is the cross section area of the pipe,  $\rho$  (SI unit:  $\text{kg}/\text{m}^3$ ) is the density,  $\mathbf{u}$  (SI unit:  $\text{m}/\text{s}$ ) is the fluid velocity, and  $p$  (SI unit:  $\text{N}/\text{m}^2$ ) is the pressure.

The second term on the right-hand side of Equation 1 describes the pressure drop due to internal viscous shear. The term contains the Darcy friction factor,  $f_D$ , which is a function of the Reynolds number and the surface roughness divided by the hydraulic pipe diameter. In this example,  $f_D$  is calculated from the Haaland equation (Ref. 1). It can recover both small and large relative roughness limits for a wide range of Reynolds numbers ( $4 \cdot 10^3 < \text{Re} < 1 \cdot 10^8$ ):

$$\sqrt{\frac{1}{f_D}} = -1.8 \log_{10} \left( \left( \frac{e/d}{3.7} \right)^{1.11} + \left( \frac{6.9}{\text{Re}} \right) \right) \quad (2)$$

The pipe flow interfaces have the Haaland equation and several other friction models predefined and automatically calculate the friction factor based on the local properties of the pipe, the fluid physical properties, and the fluid velocity.

## HEAT TRANSFER EQUATIONS

The energy equation the pipeline flow is:

$$\rho A C_p \mathbf{u} \cdot \nabla T = \nabla \cdot A k \nabla T + f_D \frac{\rho A}{2d_h} |\mathbf{u}|^3 + Q_{\text{wall}} \quad (3)$$

where  $C_p$  (SI unit:  $\text{J}/(\text{kg} \cdot \text{K})$ ) is the heat capacity at constant pressure,  $T$  is the temperature (SI unit:  $\text{K}$ ), and  $k$  (SI unit:  $\text{W}/(\text{m} \cdot \text{K})$ ) is the thermal conductivity. The second term on the right-hand side of Equation 3 corresponds to heat released due to the work of internal friction forces.  $Q_{\text{wall}}$  (SI unit:  $\text{W}/\text{m}$ ) is a source/sink term due to heat exchange with the surroundings through the pipe wall:

$$Q_{\text{wall}} = hZ(T_{\text{ext}} - T)$$

Where  $Z$  (m) is the perimeter of the pipe,  $h$  ( $\text{W}/(\text{m}^2 \cdot \text{K})$ ) an overall heat transfer coefficient and  $T_{\text{ext}}$  (K) the external temperature outside the pipe.

The overall heat transfer coefficient includes contribution from internal film resistance, wall resistance, and external film resistance.

For a circular pipe, assuming equal temperature around the circumference of the pipe, and that the heat transfer through the wall is quasi static, an effective  $hZ$  in Equation 3 is given by

$$(hZ)_{\text{eff}} = \frac{2\pi}{\frac{1}{r_0 h_{\text{int}}} + \frac{1}{r_N h_{\text{ext}}} + \sum_{n=1}^N \left( \frac{\ln\left(\frac{r_n}{r_{n-1}}\right)}{k_n} \right)}$$

where  $r_n$  is the outer radius of wall  $n$ ,  $h_{\text{int}}$ , and  $h_{\text{ext}}$  are the film heat transfer coefficients on the inside and outside of the tube, respectively, and  $k_n$  is the thermal conductivity of wall  $n$ . In this model, the pipe wall and one layer of insulation is modeled (Figure 2)

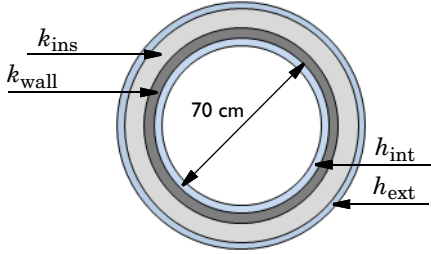

Figure 2: Pipeline cross section. A two layered wall (dark and light gray) and the film resistances on the inside and outside (light blue).

Properties of the pipe and insulation material is given in the table below.

TABLE 1: PIPE PROPERTIES.

NAME	VALUE	DESCRIPTION
$d_{\text{wall}}$	2 cm	Pipe wall thickness
$k_{\text{wall}}$	45 W/(m·K)	Pipe wall thermal conductivity
$d_{\text{ins}}$	To be determined	Insulation thickness
$k_{\text{ins}}$	0.025 W/(m·K)	Insulation thermal conductivity

The film resistance inside the pipe is given by:

$$h_{\text{int}} = \text{Nu}_{\text{int}} \frac{k_{\text{oil}}}{d}$$

with the following Nusselt correlation (Ref. 2):

$$\text{Nu}_{\text{int}} = \frac{(f_D/8)(\text{Re} - 1000)\text{Pr}}{1 + \sqrt{12.7}(\text{Pr}^{2/3} - 1)}$$

The film resistance due to the external flow of air around the pipeline is:

$$h_{\text{ext}} = \text{Nu}_{\text{ext}} \frac{k_{\text{air}}}{d}$$

where  $\text{Nu}_{\text{ext}}$  is calculated with a forced convection relation, assuming an average air speed of 5 m/s.

$$\text{Nu}_{\text{ext}} = 0.3 + \frac{0.62\sqrt{\text{RePr}}^{1/3}}{[1 + (0.4/\text{Pr})^{2/3}]^{1/4}} [1 + (\text{Re}/282,000)^{5/8}]^{4/5}$$

### *Results and Discussion*

---

A first study calculates the temperature along the pipeline assuming perfect insulation, as well as case where the pipeline is uninsulated. [Figure 3](#) shows that the heat generated due

to friction increases the temperature of the oil by approximately 3°C over 150 km. With no pipeline insulation the temperature at the outlet is close to that of the surroundings.

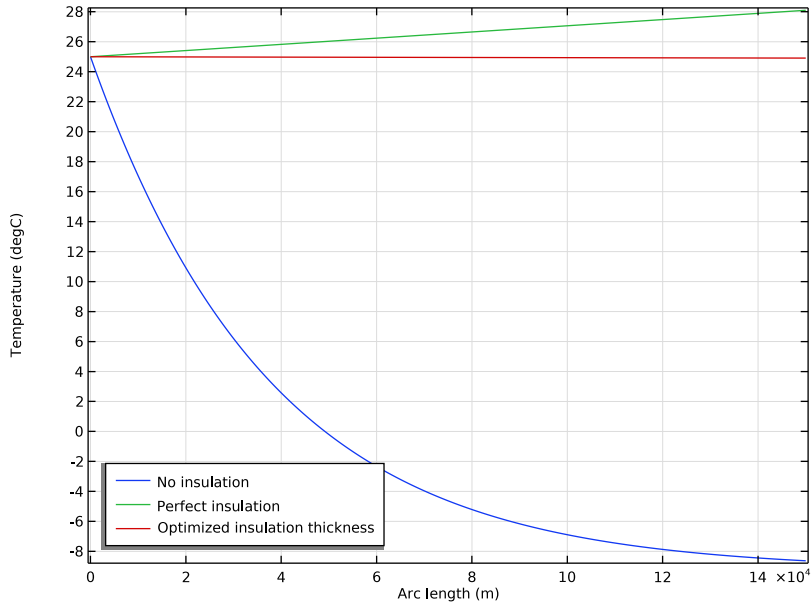

Figure 3: Oil temperature as a function of position in the pipeline assuming no heat transfer across the pipe wall, heat transfer with no insulating material around the pipe, and with an optimized insulation thickness.

Optimization calculations performed under the constraint that the temperature at the outlet should be the same as inlet temperature, predicts that the thickness of the insulating material should be approximately 8.6 cm.

It is always advisable to check the Reynolds number and verify that the friction model is valid under the present flow conditions. In this case  $Re = 1.1 \cdot 10^5$  confirming that the Haaland equation is valid for calculating  $f_D$ .

Figure 4 shows the temperature distribution in the pipe insulation layer visualized using a special Pipe dataset.

d\_ins(1)=0.08625 m Surface: Temperature (°C) Surface: Temperature of Steel pipe wall (Wall Heat Transfer 1) (°C) Surface: Temperature of Insulation layer (Wall Heat Transfer 1) (°C)

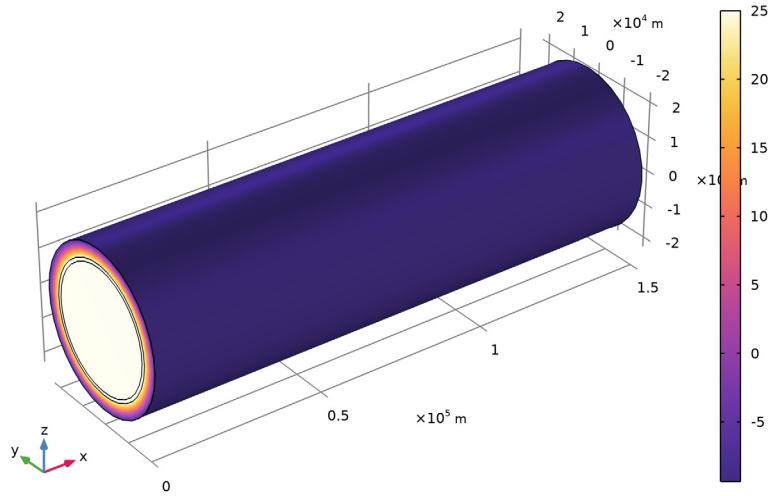

Figure 4: Temperature distribution.

### Notes About the COMSOL Implementation

This modeling example involves three study.

- 1 The oil's temperature is calculated accounting for friction heating and heat lost to the surroundings when the pipeline is uninsulated.
- 2 The other extreme case is computed: perfect insulation (no heat leakage to the surroundings).
- 3 The optimal thickness of an insulating layer is computed through optimization. The insulation thickness is sought so that the outlet temperature is equal to the inlet temperature.

### References

1. S.E. Haaland, "Simple and Explicit Formulas for the Friction Factor in Turbulent Flow," *J. Fluids Engineering (ASME)*, vol. 103, no. 5, pp. 89–90, 1983.

2. F.P. Incropera and D.P. DeWitt, *Fundamentals of Heat and Mass Transfer*, 4th ed., John Wiley & Sons, 1996. Eq 8.62 and Eq 7.55, respectively.

---

**Application Library path:** Pipe\_Flow\_Module/Heat\_Transfer/  
pipeline\_insulation

---

### *Modeling Instructions*



---

From the **File** menu, choose **New**.

#### **NEW**

In the **New** window, click  **Model Wizard**.

#### **MODEL WIZARD**

- 1 In the **Model Wizard** window, Start by setting up the nonisothermal flow problem, solving for the cases of perfect insulation and no insulation of the pipeline.
- 2 click  **3D**.
- 3 In the **Select Physics** tree, select **Fluid Flow > Nonisothermal Flow > Nonisothermal Pipe Flow (nipfl)**.
- 4 Click **Add**.
- 5 Click  **Study**.
- 6 In the **Select Study** tree, select **General Studies > Stationary**.
- 7 Click  **Done**.

#### **GEOMETRY I**

##### *Polygon 1 (poll)*

- 1 In the **Geometry** toolbar, click  **More Primitives** and choose **Polygon**.
- 2 In the **Settings** window for **Polygon**, locate the **Coordinates** section.
- 3 In the table, enter the following settings:

<b>x (m)</b>	<b>y (m)</b>	<b>z (m)</b>
0	0	0
0	0	0
150e3	0	0

4 Click  **Build Selected**.

Next, import parameter values from text file.

## GLOBAL DEFINITIONS

### *Parameters 1*

- 1 In the **Model Builder** window, under **Global Definitions** click **Parameters 1**.
- 2 In the **Settings** window for **Parameters**, locate the **Parameters** section.
- 3 Click  **Load from File**.
- 4 Browse to the model's Application Libraries folder and double-click the file `pipeline_insulation_parameters.txt`.

## MATERIALS

Now create the crude oil material needed for the simulation. The air properties needed for the external forced convection cooling is taken from the built-in materials database.

### *Crude oil*

- 1 In the **Model Builder** window, under **Component 1 (comp1)** right-click **Materials** and choose **Blank Material**.
- 2 In the **Settings** window for **Material**, type `Crude oil` in the **Label** text field.
- 3 Locate the **Material Contents** section. In the table, enter the following settings:

Property	Variable	Value	Unit	Property group
Density	rho	rho_oil	kg/m <sup>3</sup>	Basic
Dynamic viscosity	mu	mu_oil	Pa·s	Basic
Heat capacity at constant pressure	Cp	Cp_oil	J/(kg·K)	Basic
Ratio of specific heats	gamma	gamma_oil	1	Basic
Thermal conductivity	k_iso ; kii = k_iso, kij = 0	k_oil	W/(m·K)	Basic

## ADD MATERIAL

- 1 In the **Materials** toolbar, click  **Add Material** to open the **Add Material** window.
- 2 Go to the **Add Material** window.
- 3 In the tree, select **Built-in > Air**.
- 4 Click the **Add to Component** button in the window toolbar.

5 In the **Materials** toolbar, click  **Add Material** to close the **Add Material** window.

## MATERIALS

### *Air (mat2)*

Use the default settings for the **Nonisothermal Pipe Flow** and the **Fluid I** nodes. You can click them if you want to inspect the defaults.

## NONISOTHERMAL PIPE FLOW (NIPFL)

### *Pipe Properties I*

- 1 In the **Model Builder** window, under **Component I (comp1)** > **Nonisothermal Pipe Flow (nipfl)** click **Pipe Properties I**.
- 2 In the **Settings** window for **Pipe Properties**, locate the **Pipe Shape** section.
- 3 From the list, choose **Circular**.
- 4 In the  $d_i$  text field, type 70[ cm].
- 5 Locate the **Flow Resistance** section. From the **Friction model** list, choose **Haaland**.
- 6 From the **Surface roughness** list, choose **Commercial steel (0.046 mm)**.

### *Temperature I*

- 1 In the **Model Builder** window, click **Temperature I**.
- 2 In the **Settings** window for **Temperature**, locate the **Temperature** section.
- 3 In the  $T_{in}$  text field, type T\_in.

### *Heat Outflow I*

- 1 In the **Physics** toolbar, click  **Points** and choose **Heat Outflow**.
- 2 Select Point 2 only.

### *Inlet I*

- 1 In the **Physics** toolbar, click  **Points** and choose **Inlet**.
- 2 Select Point 1 only.
- 3 In the **Settings** window for **Inlet**, locate the **Inlet Specification** section.
- 4 From the **Specification** list, choose **Volumetric flow rate**.
- 5 In the  $q_{v,0}$  text field, type oil\_rate.

Next, set up the wall heat transfer components.

### *Wall Heat Transfer I*

- 1 In the **Physics** toolbar, click  **Edges** and choose **Wall Heat Transfer**.

- 2 Select Edge 1 only.
- 3 In the **Settings** window for **Wall Heat Transfer**, locate the **Heat Transfer Model** section.
- 4 In the  $T_{ext}$  text field, type  $T_{ext}$ .

#### *Internal Film Resistance 1*

In the **Physics** toolbar, click  **Attributes** and choose **Internal Film Resistance**.

#### *Wall Heat Transfer 1*

Add two layers of wall material.

- 1 In the **Model Builder** window, click **Wall Heat Transfer 1**.

#### *Steel pipe wall*

- 1 In the **Physics** toolbar, click  **Attributes** and choose **Wall Layer**.
- 2 In the **Settings** window for **Wall Layer**, type Steel pipe wall in the **Label** text field.
- 3 Locate the **Specification** section. From the  $k$  list, choose **User defined**.
- 4 In the text field, type  $k_{wall}$ .
- 5 From the  $\Delta w$  list, choose **User defined**.
- 6 In the text field, type  $d_{wall}$ .

#### *Wall Heat Transfer 1*

In the **Model Builder** window, click **Wall Heat Transfer 1**.

#### *Insulation layer*

- 1 In the **Physics** toolbar, click  **Attributes** and choose **Wall Layer**.
- 2 In the **Settings** window for **Wall Layer**, type Insulation layer in the **Label** text field.
- 3 Locate the **Specification** section. From the  $k$  list, choose **User defined**.
- 4 In the text field, type  $k_{ins}$ .
- 5 From the  $\Delta w$  list, choose **User defined**.
- 6 In the text field, type  $d_{ins}$ .

#### *Wall Heat Transfer 1*

Now add the external film resistance to model the forced convection.

- 1 In the **Model Builder** window, click **Wall Heat Transfer 1**.

#### *External Film Resistance 1*

- 1 In the **Physics** toolbar, click  **Attributes** and choose **External Film Resistance**.
- 2 In the **Settings** window for **External Film Resistance**, locate the **Specification** section.

- 3 From the **Surrounding fluid** list, choose **Air (mat2)**.
- 4 In the  $u_{ext}$  text field, type `v_air`.

#### **MESH 1**

- 1 In the **Model Builder** window, under **Component 1 (comp1)** click **Mesh 1**.
- 2 In the **Settings** window for **Mesh**, locate the **Physics-Controlled Mesh** section.
- 3 From the **Element size** list, choose **Extra fine**.
- 4 Click  **Build All**.

#### **STUDY 1**

The first study calculates the temperature for the uninsulated pipeline.

##### *Step 1: Stationary*

- 1 In the **Model Builder** window, under **Study 1** click **Step 1: Stationary**.
- 2 In the **Settings** window for **Stationary**, locate the **Physics and Variables Selection** section.
- 3 Select the **Modify model configuration for study step** checkbox.
- 4 In the tree, select **Component 1 (comp1) > Nonisothermal Pipe Flow (nipfl) > Wall Heat Transfer 1 > Insulation layer**.
- 5 Right-click and choose **Disable**.
- 6 In the **Model Builder** window, click **Study 1**.
- 7 In the **Settings** window for **Study**, locate the **Study Settings** section.
- 8 Clear the **Generate default plots** checkbox.
- 9 In the **Label** text field, type `No insulation`.
- 10 In the **Study** toolbar, click  **Compute**.

#### **RESULTS**

Plot the temperature distribution along the pipeline.

##### *ID Plot Group 1*

In the **Results** toolbar, click  **ID Plot Group**.

##### *Line Graph 1*

- 1 Right-click **ID Plot Group 1** and choose **Line Graph**.
- 2 In the **Settings** window for **Line Graph**, locate the **Selection** section.
- 3 From the **Selection** list, choose **All edges**.



- 4 Click **Replace Expression** in the upper-right corner of the **y-Axis Data** section. From the menu, choose **Component 1 (comp1) > Nonisothermal Pipe Flow (Heat Transfer in Pipes) > T - Temperature - K**.
- 5 Locate the **y-Axis Data** section. In the **Unit** field, type degC.
- 6 Click to expand the **Legends** section. Select the **Show legends** checkbox.
- 7 From the **Legends** list, choose **Manual**.
- 8 In the table, enter the following settings:

Legends
No insulation

- 9 In the **ID Plot Group 1** toolbar, click  **Plot**.

Add the second study for the perfect insulation case.

#### ADD STUDY

- 1 In the **Home** toolbar, click  **Add Study** to open the **Add Study** window.
- 2 Go to the **Add Study** window.
- 3 Find the **Studies** subsection. In the **Select Study** tree, select **General Studies > Stationary**.
- 4 Click the **Add Study** button in the window toolbar.
- 5 In the **Home** toolbar, click  **Add Study** to close the **Add Study** window.

#### STUDY 2

##### *Step 1: Stationary*

- 1 In the **Settings** window for **Stationary**, locate the **Physics and Variables Selection** section.
- 2 Select the **Modify model configuration for study step** checkbox.
- 3 In the tree, select **Component 1 (comp1) > Nonisothermal Pipe Flow (nipfl) > Wall Heat Transfer 1**.
- 4 Right-click and choose **Disable**.
- 5 In the **Model Builder** window, click **Study 2**.
- 6 In the **Settings** window for **Study**, locate the **Study Settings** section.
- 7 Clear the **Generate default plots** checkbox.
- 8 In the **Label** text field, type Perfect insulation.
- 9 In the **Study** toolbar, click  **Compute**.

## RESULTS

### *Line Graph 2*

- 1 In the **Model Builder** window, under **Results > ID Plot Group 1** right-click **Line Graph 1** and choose **Duplicate**.
- 2 In the **Settings** window for **Line Graph**, locate the **Data** section.
- 3 From the **Dataset** list, choose **Perfect insulation/Solution 2 (sol2)**.
- 4 Locate the **Legends** section. In the table, enter the following settings:

---

<b>Legends</b>
Perfect insulation

---

- 5 In the **ID Plot Group 1** toolbar, click  **Plot**.  
Finish the plot by adjusting the title and legend positioning.

### *ID Plot Group 1*

- 1 In the **Model Builder** window, click **ID Plot Group 1**.
- 2 In the **Settings** window for **ID Plot Group**, click to expand the **Title** section.
- 3 From the **Title type** list, choose **None**.
- 4 Locate the **Legend** section. From the **Position** list, choose **Lower left**.

5 In the **ID Plot Group 1** toolbar, click  **Plot**.

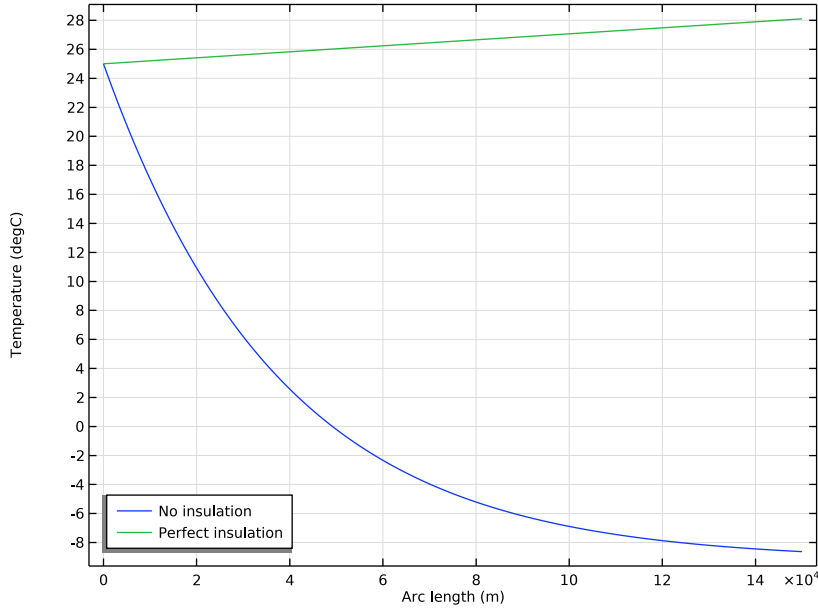

## DEFINITIONS

Next, set up the study to optimize the insulation thickness.

### Integration 1 (intop1)



- 1 In the **Definitions** toolbar, click  **Nonlocal Couplings** and choose **Integration**.
- 2 In the **Settings** window for **Integration**, locate the **Source Selection** section.
- 3 From the **Geometric entity level** list, choose **Point**.
- 4 Select Point 2 only.

### Variables 1

- 1 In the **Definitions** toolbar, click  **Local Variables**.
- 2 In the **Settings** window for **Variables**, locate the **Variables** section.
- 3 In the table, enter the following settings:

Name	Expression	Unit	Description
T_diff	intop1((T_in-T)^2)	K <sup>2</sup>	

## ADD STUDY

- 1 In the **Home** toolbar, click  **Add Study** to open the **Add Study** window.
- 2 Go to the **Add Study** window.
- 3 Find the **Studies** subsection. In the **Select Study** tree, select **General Studies > Stationary**.
- 4 Click the **Add Study** button in the window toolbar.
- 5 In the **Home** toolbar, click  **Add Study** to close the **Add Study** window.

## STUDY 3

### *General Optimization*

- 1 In the **Study** toolbar, click  **Optimization** and choose **General Optimization**.
- 2 In the **Settings** window for **General Optimization**, locate the **Objective Function** section.
- 3 In the table, enter the following settings:

Expression	Description	Evaluate for
comp1.T_diff		Stationary

- 4 Locate the **Control Variables and Parameters** section. Click  **Add**.
- 5 In the table, enter the following settings:

Parameter	Initial value	Scale	Lower bound	Upper bound	Unit
d_ins (Thickness of insulation layer)	3 [cm]	1			m

- 6 In the **Model Builder** window, click **Study 3**.
- 7 In the **Settings** window for **Study**, locate the **Study Settings** section.
- 8 Clear the **Generate default plots** checkbox.
- 9 In the **Label** text field, type Insulation thickness optimization.
- 10 In the **Study** toolbar, click  **Compute**.

## RESULTS

### *Temperature*

- 1 In the **Model Builder** window, under **Results** click **ID Plot Group 1**.
- 2 In the **Settings** window for **ID Plot Group**, type Temperature in the **Label** text field.

### Line Graph 3

- 1 In the **Model Builder** window, under **Results > Temperature** right-click **Line Graph 2** and choose **Duplicate**.
- 2 In the **Settings** window for **Line Graph**, locate the **Data** section.
- 3 From the **Dataset** list, choose **Insulation thickness optimization/Solution 3 (sol3)**.
- 4 Locate the **Legends** section. In the table, enter the following settings:

Legends
Optimized insulation thickness

- 5 In the **Temperature** toolbar, click  **Plot**.  
Compare this plot with [Figure 3](#).

### Objective Table 2

Scroll down the table to find the resulting values of the insulation thickness.

Plot a temperature distribution in the pipe with optimized insulation thickness using a special Pipe dataset.

- 1 From the **Results** menu, choose **Result Templates**.

### RESULT TEMPLATES



- 1 Go to the **Result Templates** window.
- 2 In the tree, select **Insulation thickness optimization/Parametric Solutions 1 (sol4) > Nonisothermal Pipe Flow > Temperature, 3D (nipfl)**.
- 3 Click the **Add Result Template** button in the window toolbar.
- 4 From the **Results** menu, choose **Result Templates**.

### RESULTS



#### Temperature, 3D (nipfl)

In the **Model Builder** window, expand the **Results > Tables** node.



#### Pipe

- 1 In the **Model Builder** window, expand the **Results > Datasets** node, then click **Pipe**.
- 2 In the **Settings** window for **Pipe**, locate the **Cross Section** section.
- 3 In the **Scale** text field, type 50e3.
- 4 Click  **Plot**.
- 5 Click the  **Zoom Extents** button in the **Graphics** toolbar.

### Temperature, 3D (nipfl)

- 1 In the **Model Builder** window, under **Results** click **Temperature, 3D (nipfl)**.
- 2 In the **Settings** window for **3D Plot Group**, locate the **Plot Settings** section.
- 3 Select the **Plot dataset edges** checkbox.
- 4 Click the  **Zoom Extents** button in the **Graphics** toolbar.
- 5 In the **Temperature, 3D (nipfl)** toolbar, click  **Plot**.



### Preferred Units 1

- 1 In the **Results** toolbar, click  **Configurations** and choose **Preferred Units**.
- 2 In the **Settings** window for **Preferred Units**, locate the **Units** section.
- 3 Click  **Add Physical Quantity**.
- 4 In the **Physical Quantity** dialog, select **General > Temperature (K)** in the tree.
- 5 Click **OK**.
- 6 In the **Settings** window for **Preferred Units**, locate the **Units** section.
- 7 In the table, enter the following settings:

Quantity	Unit	Preferred unit
Temperature	K	°C

- 8 Click  **Apply**.

### Temperature, 3D (nipfl)

- 1 In the **Model Builder** window, under **Results** click **Temperature, 3D (nipfl)**.
- 2 In the **Settings** window for **3D Plot Group**, locate the **Plot Settings** section.
- 3 From the **View** list, choose **New view** to generate a dedicated view for this plot.
- 4 In the **Temperature, 3D (nipfl)** toolbar, click  **Plot**.
- 5 Click the  **Zoom Extents** button in the **Graphics** toolbar.
- 6 Click  **Go to Source**.

### Section View

- 1 In the **Model Builder** window, under **Results > Views** click **View 3D 2**.
- 2 In the **Settings** window for **View 3D**, type Section View in the **Label** text field.