



Model created in COMSOL Multiphysics 6.4

# Coupled Analysis of Flow and Stress in a Pipe

## Introduction

---

In this tutorial model, the flow in a pipe with a bend is computed using the Pipe Flow interface. The computed fluid load is used as input to a stress analysis in the Pipe Mechanics interface. Gravity loads from the pipe and fluid are also taken into account.

## Model Definition

---

A circular pipe with outer diameter  $d_o = 10$  cm consists of two straight 8 m long sections that are connected by a smooth 90-degree circular bend with a radius  $r_b = 2$  m; see [Figure 1](#).

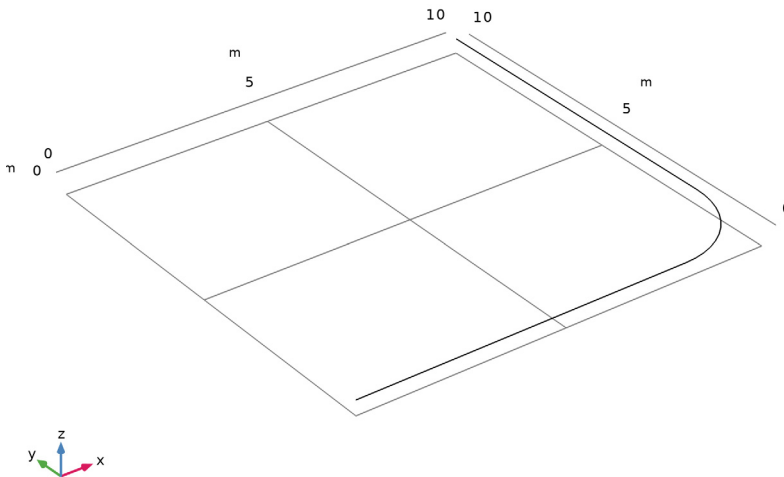

*Figure 1: Pipe geometry.*

Both ends are fixed, and the pipe is placed on three evenly spaced vertical supports.

The pipe wall thickness is  $t = 4$  mm, so that the inner diameter is  $d_i = 9.2$  cm. The inlet and outlet pressure are kept at 50 bar and 40 bar, respectively. A stationary flow of water in the pipe is driven by the resulting pressure drop. The pressure outside the pipe is assumed to be negligible. Thus, a significant internal overpressure,  $p$ , causes a hoop stress in the pipe walls.

The pipe is made of steel and has the inner surface roughness of  $e = 0.046$  mm.

The system is subjected to the gravity, so that the pipe and fluid weights cause the pipe's vertical bending. In addition, the flow acts on the pipe in two ways: the drag force due to the wall friction, and the centrifugal force in the bend. Both forces lead to the pipe horizontal deflection and bending.

The drag force acts along the pipe and is estimated using the Swamee–Jain formula (Ref. 1)

$$f_D = \frac{0.25}{\left(\log_{10}\left(\left(\frac{e/d_i}{3.7}\right) + \frac{5.74}{(\text{Re})^{0.9}}\right)\right)^2}$$

which is valid for relative roughness  $1 \cdot 10^{-6} < e/d_i < 1 \cdot 10^{-2}$  and  $5 \cdot 10^3 < \text{Re} < 1 \cdot 10^8$ . The Reynolds number is  $\text{Re} = \rho u d_i / \mu$ , where  $u$  is the flow velocity,  $\rho$  is water density, and  $\mu$  is the dynamic viscosity.

The centrifugal force acts outward the bend perpendicular to the pipe, and its magnitude is given by:  $\rho A u^2 / r_b$ , where  $A$  is the area of the pipe inner cross section.

## Results and Discussion

The pressure distribution inside the pipe is shown in [Figure 2](#). The flow has a uniform velocity around 23.8 m/s along the whole pipe, which corresponds to the Reynolds number  $Re = 2.2 \cdot 10^6$  that indicates that the flow regime is highly turbulent.

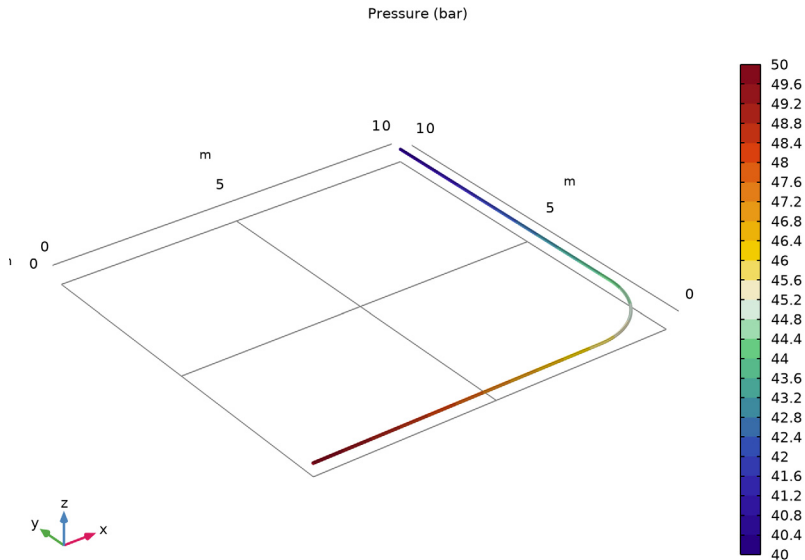

*Figure 2: Pressure distribution.*

The stress distribution in the pipe walls is shown in [Figure 3](#). Due to the pressure drop in the fluid, the value is higher at the inlet than at the outlet. The pipe displacement

components are shown in [Figure 4](#). The importance of the vertical supports is clearly visible.

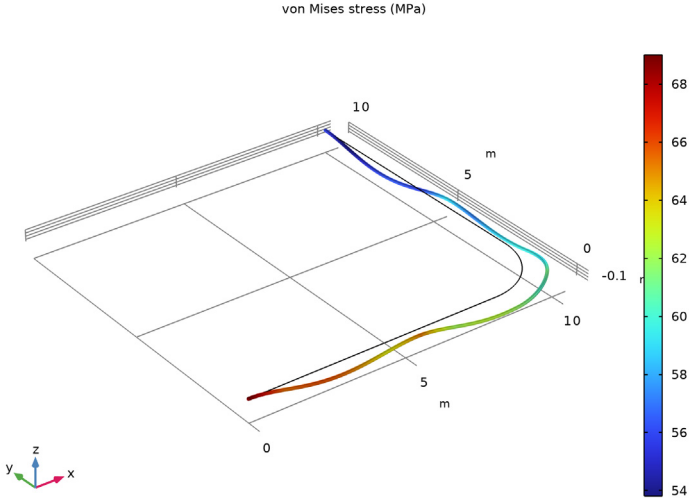

*Figure 3: von Mises stress distribution along the deformed pipe. The deformation is magnified.*

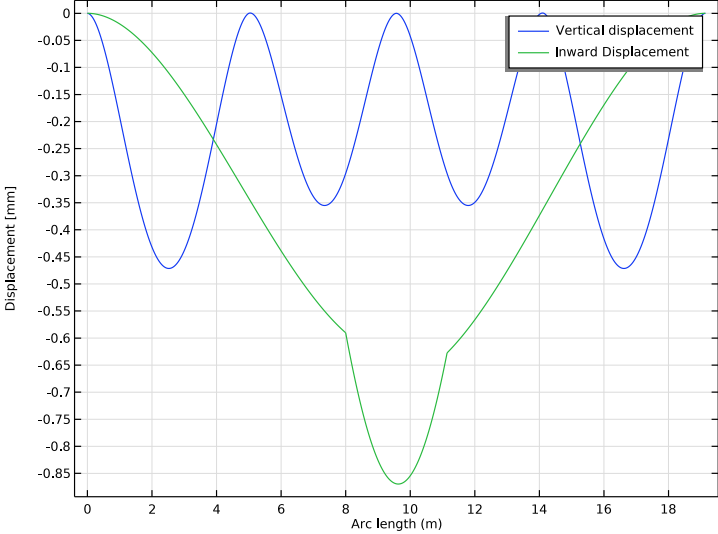

*Figure 4: Pipe displacement.*

The bending moments and shear forces along the pipe are shown in [Figure 5](#) and [Figure 6](#).

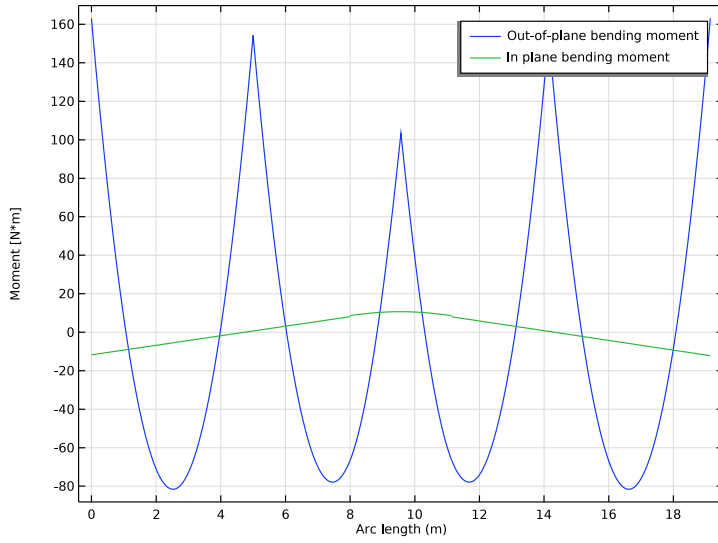

Figure 5: Bending moments.

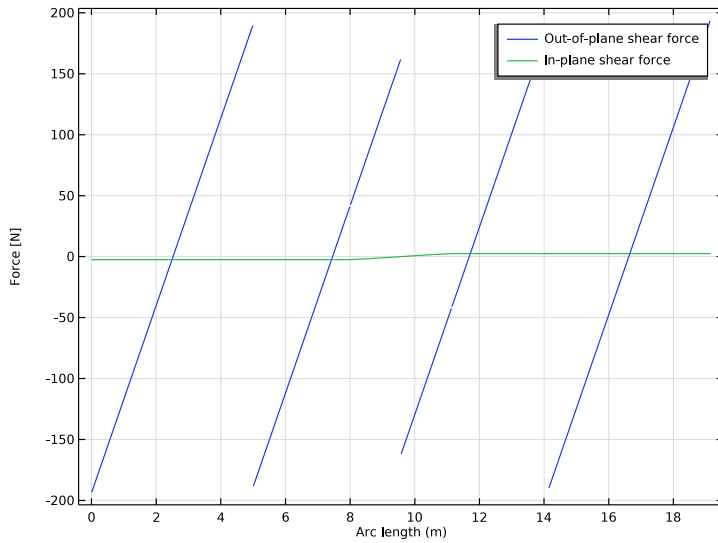

Figure 6: Shear forces.

The different contributions to the total stress state are shown in Figure 7. As is common in piping systems, the hoop stress caused by the internal pressure is dominant.

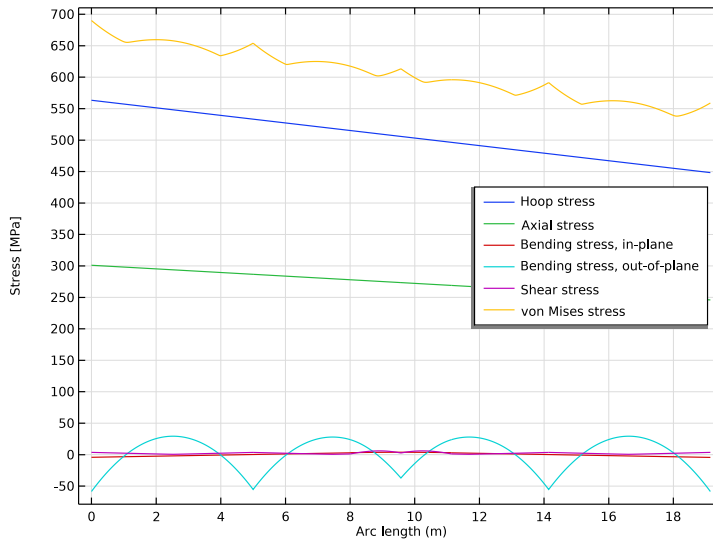

Figure 7: Stress contributions.

### Notes About the COMSOL Implementation

You start the model setup by adding a multiphysics interface, Fluid–Pipe Interaction, Fixed Geometry. This will bring in two physics interfaces, Pipe Flow and Pipe Mechanics, together with a multiphysics coupling feature, Fluid–Pipe Interaction.

The interfaces are one-way coupled. Thus, the flow will affect the structural displacement, but the pipe geometry change because of the deformation is assumed to be small and will have no effect on the flow computations.

The flow-induced forces such as internal overpressure, drag, and centrifugal forces are computed and applied on the structure automatically by the coupling feature.

The Pipe Mechanics interface needs two materials, one for the pipe wall and the other for the contained fluid. The materials are chosen in the **Fluid and Pipe Materials** node under the interface. The material selection lists will contain all materials available in the component. The material data will be taken from the selected material even if the corresponding material node has no selection or is overridden under **Materials** in the component. The **Pipe Flow** interface can only take data from an active material with proper selection made under **Materials** in the component.

The gravity contribution is added only in the **Pipe Mechanics** interface because the gravity does not affect the flow when the pipes are at the same height.

## *Reference*

---

1. P.K Swamee and A.K. Jain, “Explicit Equations for Pipe-flow Problems,” *J. Hydraulics Division (ASCE)*, vol. 102, no. 5, pp. 657–664, 1976.

---

**Application Library path:** Pipe\_Flow\_Module/Pipe\_Mechanics/pipe\_flow\_stress

---

## *Modeling Instructions*



---

From the **File** menu, choose **New**.

### **NEW**

In the **New** window, click  **Model Wizard**.

### **MODEL WIZARD**

- 1 In the **Model Wizard** window, click  **3D**.
- 2 In the **Select Physics** tree, select **Structural Mechanics > Fluid–Structure Interaction > Fluid–Pipe Interaction, Fixed Geometry**.
- 3 Click **Add**.
- 4 Click  **Study**.
- 5 In the **Select Study** tree, select **General Studies > Stationary**.
- 6 Click  **Done**.

### **GLOBAL DEFINITIONS**

#### *Parameters I*

- 1 In the **Model Builder** window, under **Global Definitions** click **Parameters I**.
- 2 In the **Settings** window for **Parameters**, locate the **Parameters** section.
- 3 Click  **Load from File**.
- 4 Browse to the model’s Application Libraries folder and double-click the file `pipe_flow_stress_parameters.txt`.

The undeformed pipe is located in the *xy*-plane.

## GEOMETRY I

*Work Plane 1 (wp1)*

In the **Geometry** toolbar, click  **Work Plane**.

The pipe consists of two straight sections connected by a circular bend.

*Work Plane 1 (wp1) > Plane Geometry*

In the **Model Builder** window, click **Plane Geometry**.

*Work Plane 1 (wp1) > Polygon 1 (pol1)*

1 In the **Work Plane** toolbar, click  **Polygon**.

2 In the **Settings** window for **Polygon**, locate the **Object Type** section.

3 From the **Type** list, choose **Open curve**.

4 Locate the **Coordinates** section. In the table, enter the following settings:

<b>xw (m)</b>	<b>yw (m)</b>
0	0
Xs	0
Xb - rb	0

*Work Plane 1 (wp1) > Circular Arc 1 (ca1)*

1 In the **Work Plane** toolbar, click  **More Primitives** and choose **Circular Arc**.

2 In the **Settings** window for **Circular Arc**, locate the **Radius** section.

3 In the **Radius** text field, type rb.

4 Locate the **Center** section. In the **xw** text field, type Xb - rb.

5 In the **yw** text field, type rb.

6 Locate the **Angles** section. In the **Start angle** text field, type 270.

7 In the **End angle** text field, type 315.

*Work Plane 1 (wp1) > Circular Arc 2 (ca2)*

1 Right-click **Component 1 (comp1) > Geometry 1 > Work Plane 1 (wp1) > Plane Geometry > Circular Arc 1 (ca1)** and choose **Duplicate**.

2 In the **Settings** window for **Circular Arc**, locate the **Angles** section.

3 In the **Start angle** text field, type 315.

4 In the **End angle** text field, type 0.

*Work Plane 1 (wp1) > Polygon 2 (pol2)*

1 In the **Work Plane** toolbar, click  **Polygon**.

- 2 In the **Settings** window for **Polygon**, locate the **Object Type** section.
- 3 From the **Type** list, choose **Open curve**.
- 4 Locate the **Coordinates** section. In the table, enter the following settings:

<b>xw (m)</b>	<b>yw (m)</b>
Xb	rb
Xb	Ys
Xb	Yout

- 5 In the **Model Builder** window, right-click **Geometry 1** and choose **Build All**.

#### **MESH 1**



- 1 In the **Model Builder** window, under **Component 1 (comp1)** click **Mesh 1**.
- 2 In the **Settings** window for **Mesh**, locate the **Physics-Controlled Mesh** section.
- 3 From the **Element size** list, choose **Extremely fine**.
- 4 Right-click **Component 1 (comp1) > Mesh 1** and choose **Edit Physics-Induced Sequence**.

#### *Size*

- 1 In the **Model Builder** window, under **Component 1 (comp1) > Mesh 1** click **Size**.
- 2 In the **Settings** window for **Size**, click to expand the **Element Size Parameters** section.
- 3 In the **Maximum element size** text field, type 0.02.
- 4 Click  **Build All**.

Add two materials for the pipe wall and contained fluid.

#### **ADD MATERIAL**

- 1 In the **Materials** toolbar, click  **Add Material** to open the **Add Material** window.
- 2 Go to the **Add Material** window.
- 3 In the tree, select **Built-in > Structural steel**.
- 4 Right-click and choose **Add to Component 1 (comp1)**.
- 5 In the tree, select **Built-in > Water, liquid**.
- 6 Right-click and choose **Add to Component 1 (comp1)**.
- 7 In the **Materials** toolbar, click  **Add Material** to close the **Add Material** window.

## MATERIALS

*Water, liquid (mat2)*

- 1 In the **Settings** window for **Material**, locate the **Geometric Entity Selection** section.
- 2 From the **Selection** list, choose **All edges**.

## PIPE FLOW (PFL)

*Pipe Properties I*

- 1 In the **Model Builder** window, under **Component 1 (comp1) > Pipe Flow (pfl)** click **Pipe Properties I**.
- 2 In the **Settings** window for **Pipe Properties**, locate the **Pipe Shape** section.
- 3 From the list, choose **Circular**.
- 4 In the  $d_i$  text field, type di.
- 5 Locate the **Flow Resistance** section. From the **Friction model** list, choose **Swamee-Jain**.
- 6 From the **Surface roughness** list, choose **Commercial steel (0.046 mm)**.

In the **Pipe Mechanics** interface, you select the materials explicitly from the list.

## PIPE MECHANICS (PIPEM)

*Fluid and Pipe Materials I*

- 1 In the **Model Builder** window, under **Component 1 (comp1) > Pipe Mechanics (pipem)** click **Fluid and Pipe Materials I**.
- 2 In the **Settings** window for **Fluid and Pipe Materials**, locate the **Fluid Properties** section.
- 3 From the **Fluid material** list, choose **Water, liquid (mat2)**.
- 4 Locate the **Pipe Properties** section. From the **Pipe material** list, choose **Structural steel (mat1)**.

*Pipe Cross Section I*

- 1 In the **Model Builder** window, click **Pipe Cross Section I**.
- 2 In the **Settings** window for **Pipe Cross Section**, locate the **Pipe Shape** section.
- 3 From the list, choose **Circular**.
- 4 In the  $d_o$  text field, type do.
- 5 In the  $d_i$  text field, type di.

Orient the pipe cross section so that the second coordinate axis of the beam coordinate system is oriented normal to the pipe in the  $xy$ -plane. The first coordinate axis is always oriented along the pipe.

#### *Section Orientation 1*

- 1 In the **Model Builder** window, click **Section Orientation 1**.
- 2 In the **Settings** window for **Section Orientation**, locate the **Section Orientation** section.
- 3 From the **Orientation method** list, choose **Orientation vector**.
- 4 Specify the  $V$  vector as

-1	X
1	Y
0	Z

#### *Pipe Cross Section 1*

In the **Model Builder** window, click **Pipe Cross Section 1**.

#### *Bend 1*

- 1 In the **Physics** toolbar, click  **Attributes** and choose **Bend**.
- 2 Select Edges 3 and 4 only.
- 3 In the **Settings** window for **Bend**, locate the **Correction Factors** section.
- 4 In the  $k_i$  text field, type  $1.65/\text{pipem.hFlex}$ .
- 5 In the  $k_o$  text field, type  $1.65/\text{pipem.hFlex}$ .
- 6 In the  $i_i$  text field, type  $0.9/(\text{pipem.hFlex})^{(2/3)}$ .
- 7 In the  $i_o$  text field, type  $0.75/(\text{pipem.hFlex})^{(2/3)}$ .

Both ends of the pipe are fixed.

#### *Fixed Constraint 1*

- 1 In the **Physics** toolbar, click  **Points** and choose **Fixed Constraint**.
- 2 Select Points 1 and 7 only.

The pipe is supported vertically at three locations.

#### *Prescribed Displacement/Rotation 1*

- 1 In the **Physics** toolbar, click  **Points** and choose **Prescribed Displacement/Rotation**.
- 2 Select Points 2, 4, and 6 only.
- 3 In the **Settings** window for **Prescribed Displacement/Rotation**, locate the **Prescribed Displacement** section.

4 From the **Displacement in z direction** list, choose **Prescribed**.

*Gravity 1*

In the **Physics** toolbar, click  **Global** and choose **Gravity**.

## PIPE FLOW (PFL)

*Pressure, inlet*

1 In the **Model Builder** window, under **Component 1 (comp1) > Pipe Flow (pfl)** click **Pressure 1**.

2 In the **Settings** window for **Pressure**, type **Pressure, inlet** in the **Label** text field.

3 Locate the **Boundary Pressure** section. In the  $p_0$  text field, type **pin**.

*Pressure, outlet*

1 In the **Physics** toolbar, click  **Points** and choose **Pressure**.

2 In the **Settings** window for **Pressure**, type **Pressure, outlet** in the **Label** text field.

3 Select **Point 7** only.

4 Locate the **Boundary Pressure** section. In the  $p_0$  text field, type **pout**.

## STUDY 1

In the **Study** toolbar, click  **Compute**.

The first three default plots show the pressure in the pipe, the flow velocity, and the stress distribution along the deformed pipe.

## RESULTS

*Preferred Units 1*

1 In the **Results** toolbar, click  **Configurations** and choose **Preferred Units**.

2 In the **Settings** window for **Preferred Units**, locate the **Units** section.

3 Click  **Add Physical Quantity**.

4 In the **Physical Quantity** dialog, select **Solid Mechanics > Stress tensor (N/m<sup>2</sup>)** in the tree.

5 Click **OK**.

6 In the **Settings** window for **Preferred Units**, locate the **Units** section.

7 In the table, enter the following settings:

Quantity	Unit	Preferred unit
Stress tensor	N/m <sup>2</sup>	MPa

- 8 Click  **Add Physical Quantity**.
- 9 In the **Physical Quantity** dialog, select **General > Pressure (Pa)** in the tree.
- 10 Click **OK**.
- 11 In the **Settings** window for **Preferred Units**, locate the **Units** section.
- 12 In the table, enter the following settings:

Quantity	Unit	Preferred unit
Pressure	Pa	bar

- 13 Click  **Apply**.

#### *Line 1*

- 1 In the **Model Builder** window, expand the **Pressure (pfl)** node, then click **Line 1**.
- 2 In the **Pressure (pfl)** toolbar, click  **Plot**.

#### *Velocity (pfl)*

- 1 In the **Model Builder** window, under **Results** click **Velocity (pfl)**.
- 2 In the **Settings** window for **3D Plot Group**, locate the **Color Legend** section.
- 3 Select the **Show units** checkbox.

#### *Displacement*

- 1 In the **Results** toolbar, click  **ID Plot Group**.  
Add a plot of the pipe displacement components.
- 2 In the **Settings** window for **ID Plot Group**, type Displacement in the **Label** text field.
- 3 Locate the **Plot Settings** section.
- 4 Select the **y-axis label** checkbox. In the associated text field, type Displacement [mm].

#### *Line Graph 1*

- 1 Right-click **Displacement** and choose **Line Graph**.
- 2 In the **Settings** window for **Line Graph**, locate the **Selection** section.
- 3 From the **Selection** list, choose **All edges**.
- 4 Locate the **y-Axis Data** section. In the **Expression** text field, type w\_pipe.
- 5 From the **Unit** list, choose **mm**.
- 6 Click to expand the **Title** section. From the **Title type** list, choose **None**.
- 7 Click to expand the **Legends** section. Select the **Show legends** checkbox.
- 8 From the **Legends** list, choose **Manual**.

9 In the table, enter the following settings:

---

<b>Legends</b>
Vertical displacement

---

#### *Line Graph 2*

- 1 Right-click **Line Graph 1** and choose **Duplicate**.
- 2 In the **Settings** window for **Line Graph**, locate the **y-Axis Data** section.
- 3 In the **Expression** text field, type `u_pipe*pipem.beamsys.e_y1+v_pipe*pipem.beamsys.e_y2`.
- 4 Locate the **Legends** section. In the table, enter the following settings:

---

<b>Legends</b>
Inward Displacement

---

- 5 In the **Displacement** toolbar, click  **Plot**.

Next, plot the moment and force distributions along the pipe.

#### *Bending Moment*

- 1 In the **Model Builder** window, right-click **Displacement** and choose **Duplicate**.
- 2 In the **Settings** window for **ID Plot Group**, type Bending Moment in the **Label** text field.
- 3 Locate the **Plot Settings** section. In the **y-axis label** text field, type Moment [N\*m].

#### *Line Graph 1*

- 1 In the **Model Builder** window, expand the **Bending Moment** node, then click **Line Graph 1**.
- 2 In the **Settings** window for **Line Graph**, locate the **y-Axis Data** section.
- 3 In the **Expression** text field, type `pipem.My1`.
- 4 Locate the **Legends** section. In the table, enter the following settings:

---

<b>Legends</b>
Out-of-plane bending moment

---

- 5 Click to expand the **Quality** section. From the **Evaluation settings** list, choose **Manual**.
- 6 From the **Resolution** list, choose **No refinement**.

#### *Line Graph 2*

- 1 In the **Model Builder** window, click **Line Graph 2**.
- 2 In the **Settings** window for **Line Graph**, locate the **y-Axis Data** section.

- 3 In the **Expression** text field, type `pipem.Mz1`.
- 4 Locate the **Legends** section. In the table, enter the following settings:

<b>Legends</b>
In plane bending moment

- 5 Locate the **Quality** section. From the **Evaluation settings** list, choose **Manual**.
- 6 From the **Resolution** list, choose **No refinement**.
- 7 In the **Bending Moment** toolbar, click  **Plot**.

#### *Shear Force*

- 1 In the **Model Builder** window, right-click **Bending Moment** and choose **Duplicate**.
- 2 In the **Settings** window for **ID Plot Group**, type Shear Force in the **Label** text field.
- 3 Locate the **Plot Settings** section. In the **y-axis label** text field, type Force [N].

#### *Line Graph 1*

- 1 In the **Model Builder** window, expand the **Shear Force** node, then click **Line Graph 1**.
- 2 In the **Settings** window for **Line Graph**, locate the **y-Axis Data** section.
- 3 In the **Expression** text field, type `pipem.Tz1`.
- 4 Locate the **Legends** section. In the table, enter the following settings:

<b>Legends</b>
Out-of-plane shear force

#### *Line Graph 2*

- 1 In the **Model Builder** window, click **Line Graph 2**.
- 2 In the **Settings** window for **Line Graph**, locate the **y-Axis Data** section.
- 3 In the **Expression** text field, type `pipem.Ty1`.
- 4 Locate the **Legends** section. In the table, enter the following settings:

<b>Legends</b>
In-plane shear force

- 5 In the **Shear Force** toolbar, click  **Plot**.

#### *Stress Contributions*

- 1 In the **Results** toolbar, click  **ID Plot Group**.

Finally, create a plot to compare different stress contributions.

- 2 In the **Settings** window for **ID Plot Group**, type Stress Contributions in the **Label** text field.
- 3 Locate the **Plot Settings** section.
- 4 Select the **y-axis label** checkbox. In the associated text field, type Stress [MPa].
- 5 Locate the **Legend** section. From the **Position** list, choose **Middle right**.

*Line Graph 1*

- 1 Right-click **Stress Contributions** and choose **Line Graph**.
- 2 In the **Settings** window for **Line Graph**, locate the **Selection** section.
- 3 From the **Selection** list, choose **All edges**.
- 4 Locate the **y-Axis Data** section. In the **Expression** text field, type `pipem.shm`.
- 5 Locate the **Title** section. From the **Title type** list, choose **None**.
- 6 Locate the **Legends** section. Select the **Show legends** checkbox.
- 7 From the **Legends** list, choose **Manual**.
- 8 In the table, enter the following settings:

Legends
Hoop stress

*Line Graph 2*

- 1 Right-click **Line Graph 1** and choose **Duplicate**.
- 2 In the **Settings** window for **Line Graph**, locate the **y-Axis Data** section.
- 3 In the **Expression** text field, type `pipem.sn`.
- 4 Locate the **Legends** section. In the table, enter the following settings:

Legends
Axial stress

*Line Graph 3*

- 1 Right-click **Line Graph 2** and choose **Duplicate**.
- 2 In the **Settings** window for **Line Graph**, locate the **y-Axis Data** section.
- 3 In the **Expression** text field, type `pipem.sb1`.
- 4 Locate the **Legends** section. In the table, enter the following settings:

Legends
Bending stress, in-plane

#### Line Graph 4

- 1 Right-click **Line Graph 3** and choose **Duplicate**.
- 2 In the **Settings** window for **Line Graph**, locate the **y-Axis Data** section.
- 3 In the **Expression** text field, type `pipem.sb2`.
- 4 Locate the **Legends** section. In the table, enter the following settings:

---

<b>Legends</b>
Bending stress, out-of-plane

---

#### Line Graph 5

- 1 Right-click **Line Graph 4** and choose **Duplicate**.
- 2 In the **Settings** window for **Line Graph**, locate the **y-Axis Data** section.
- 3 In the **Expression** text field, type `sqrt(pipem.txymax^2+pipem.txzmax^2)`.
- 4 Locate the **Legends** section. In the table, enter the following settings:

---

<b>Legends</b>
Shear stress

---

#### Line Graph 6

- 1 Right-click **Line Graph 5** and choose **Duplicate**.
- 2 In the **Settings** window for **Line Graph**, locate the **y-Axis Data** section.
- 3 In the **Expression** text field, type `pipem.mises`.
- 4 Locate the **Legends** section. In the table, enter the following settings:

---

<b>Legends</b>
von Mises stress

---

- 5 In the **Stress Contributions** toolbar, click  **Plot**.