



Model created in COMSOL Multiphysics 6.4

Stress in Cooling Pipeline Network

Introduction

This example demonstrates how to model coupled flow, heat transfer, and structural deformation in a pipe network. Gravity loads from the pipe and fluid are also taken into account.

Model Definition

The cooling system consists of a pipeline network spread over the floor as shown in [Figure 1](#). The cooling fluid is water, and the flow is driven by a pump located at the ground floor. The heat is supplied to the inner spiral part of the pipeline, while the part of the pipeline located at the upper floor is cooled by the natural convection in the surrounding air. All other pipes are thermally insulated.

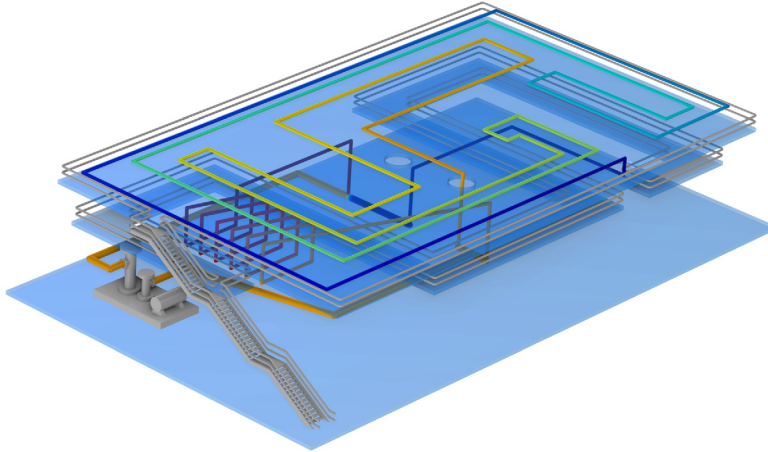

Figure 1: Geometry.

Model the pipeline in 3D as a system of connected edges using dedicated physics interfaces for computing pipe flow, pipe deformation, and heat transfer. The interfaces are based on the assumption that the diameter to length ratio is small enough to represent each individual pipe section as a 1D object. The simplified geometry is shown in [Figure 2](#). The pump is replaced by a straight pipe section connecting the pump intake and outlet positions, making the pipe system closed. The pressure increase is specified at the point representing the pipe outlet, and the pressure is set to a reference value of 1 atm at the point representing the pipe intake.

$dp(7)=0.5 \text{ atm}$

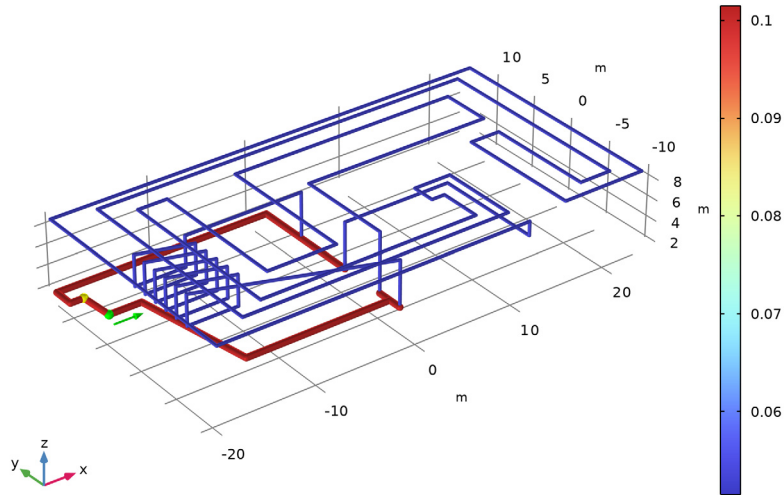

Figure 2: Simplified model geometry. The blue and red colors represent the parts of the pipeline with the pipe inner diameter of 10 cm and 20 cm, respectively. The pump position and the flow direction is highlighted in green. The reference pressure of 1 atm is prescribed at the point highlighted in yellow.

A heat source of 300 W/m is applied at the spiral part of the pipeline, while its upper part is cooled by the natural convection in the surrounding air, which has the environment temperature of 20°C .

The pipes are made of structural steel with a wall thickness of 3 mm. The whole system is subjected to gravity. The pipes are mechanically constrained by various unidirectional supports located at certain points. The fluid overpressure and other flow-induced forces act on the pipe walls. In addition, the temperature increase and variation cause thermal expansion and stress in the pipeline sections.

Results and Discussion

Compute the flow, temperature distribution, and pipe deformation and stress for the pressure increase at the pump, dp , that gradually varies from 2 atm down to 0.25 atm. The resulting maximum temperature and maximum von Mises stress over the pipeline are shown in [Figure 3](#) and [Figure 4](#), respectively.

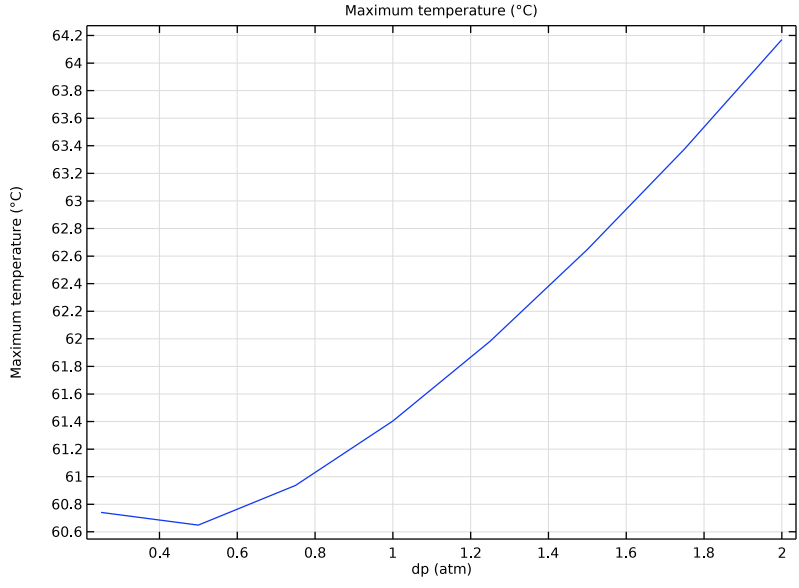

Figure 3: Maximum temperature.

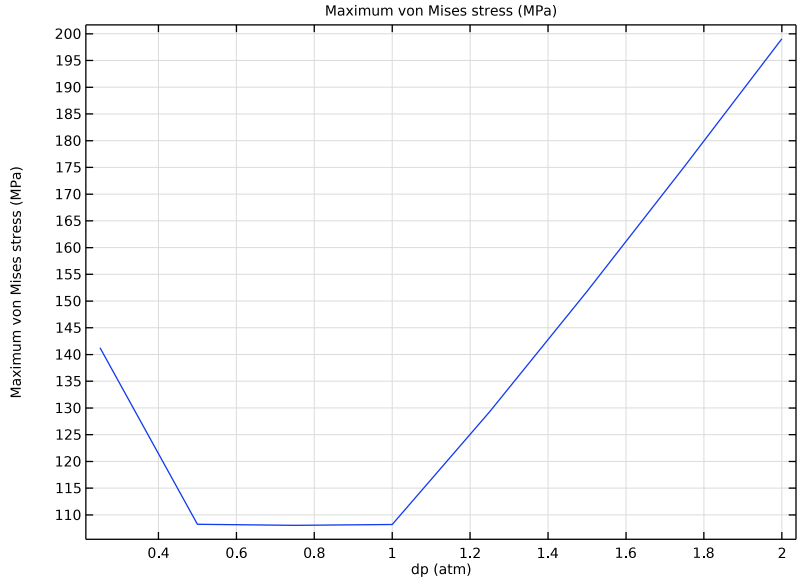

Figure 4: Maximum von Mises stress.

The plots show that both quantities assume their lowest value at dp around 0.5 atm. [Figure 5](#) shows the temperature distribution over the pipeline for that value of the parameter. Thus, the temperature increase is almost 30°C above the environment temperature. The performance can be considered acceptable since the total rate of removed heat is about 26 kW.

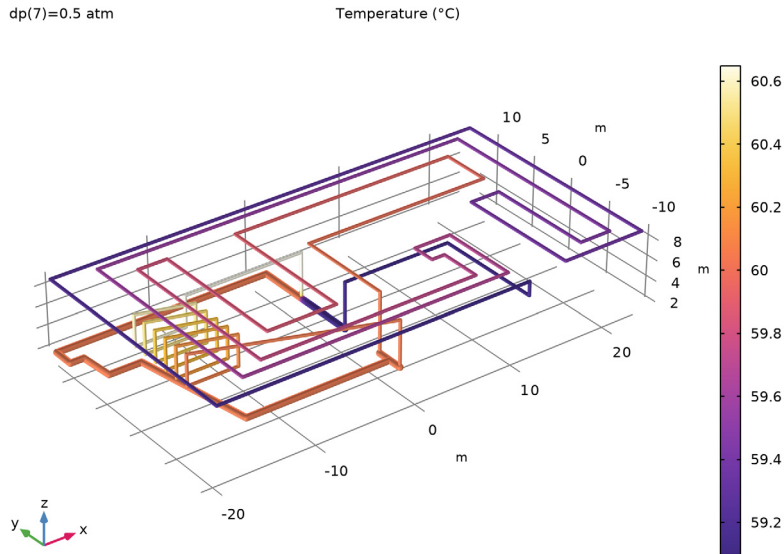

Figure 5: Temperature distribution for the pressure increase of 0.5 atm at the pump.

The fluid pressure and the velocity field for $dp = 0.5$ atm are shown in [Figure 6](#) and [Figure 7](#), respectively.

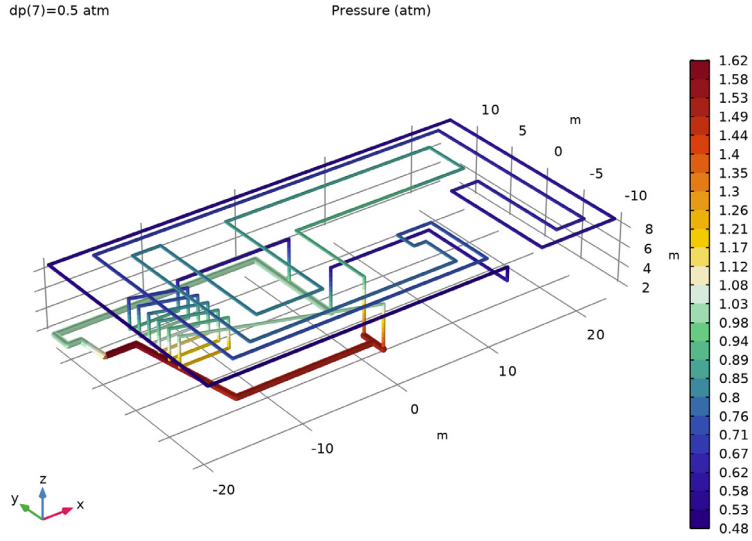

Figure 6: Fluid pressure distribution for the pressure increase of 0.5 atm at the pump.

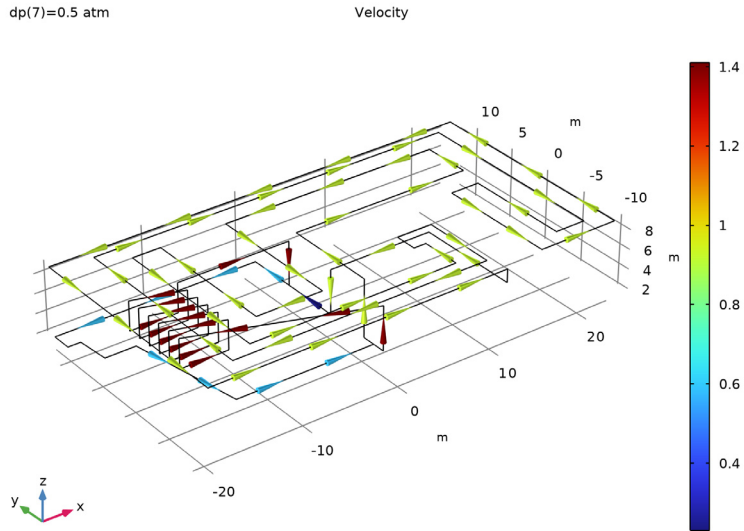

Figure 7: Flow velocity field for the pressure increase of 0.5 atm at the pump.

The stress distribution in the pipeline is shown in [Figure 8](#). The maximum von Mises stress is about 100 MPa, which is far below the yield strengths of the material.

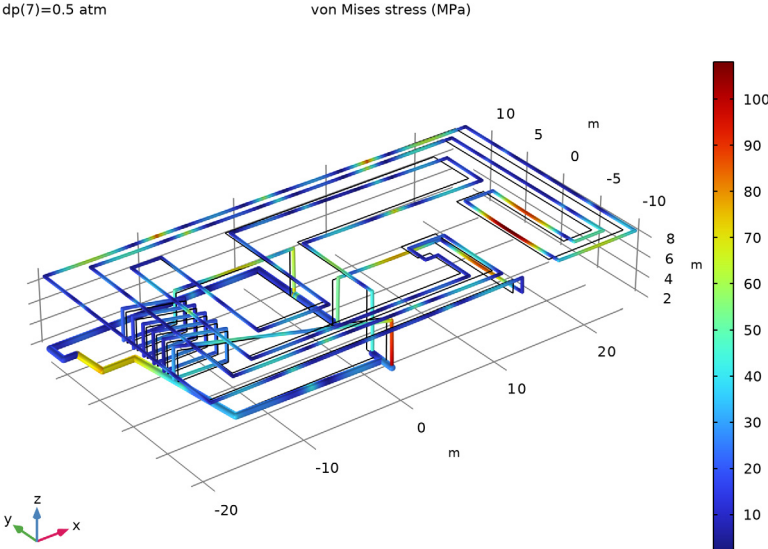

Figure 8: von Mises stress in the deformed pipeline for the pressure increase of 0.5 atm at the pump.

The following two plots show the section force and moment.

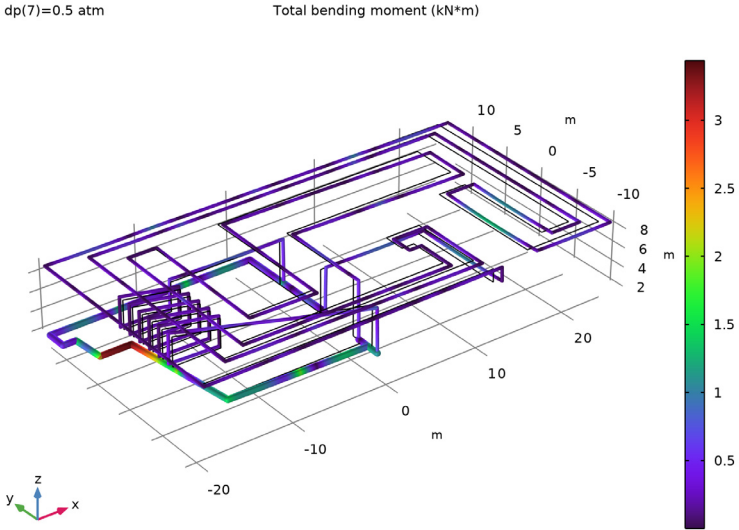

Figure 9: Total bending moment for the pressure increase of 0.5 atm at the pump.

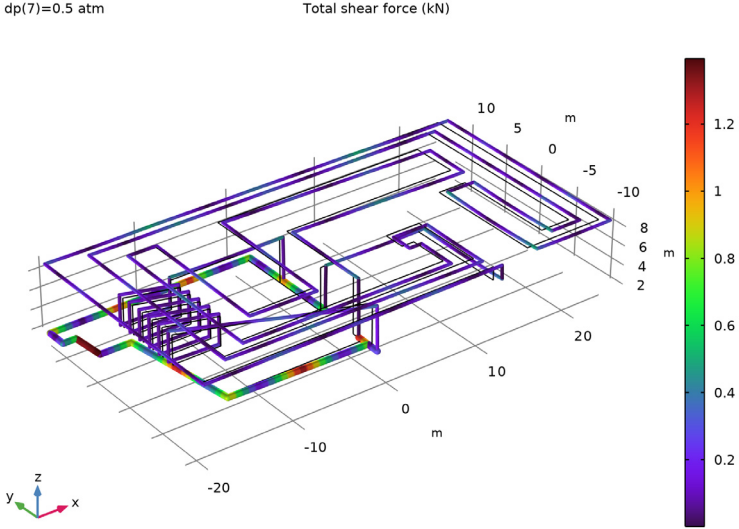

Figure 10: Total shear force for the pressure increase of 0.5 atm at the pump.

Figure 11 shows the stress distribution in the pipe section near the pump visualized using a special Pipe dataset.

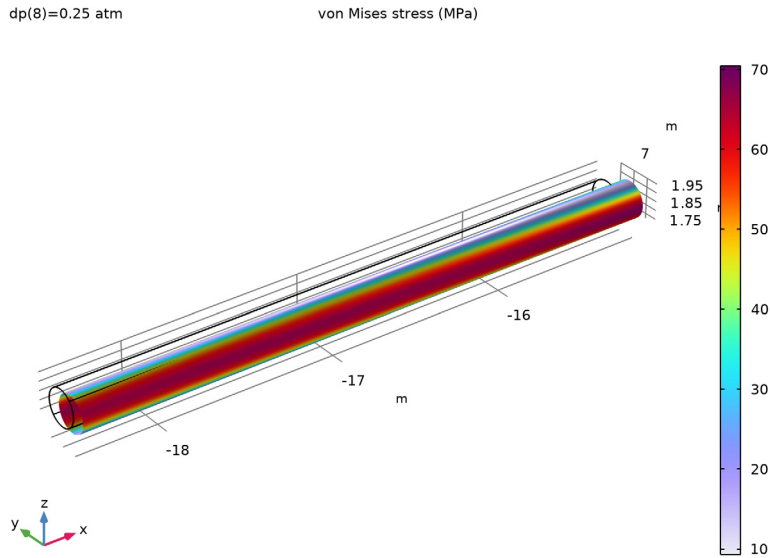

Figure 11: Stress distribution in the pipe section near the pump.

Notes About the COMSOL Implementation

Start the model setup by adding a Fluid–Pipe Interaction, Fixed Geometry multiphysics interface. This will bring in two physics interfaces, Pipe Flow and Pipe Mechanics, together with a multiphysics coupling feature, Fluid–Pipe Interaction.

The interfaces are unidirectionally coupled. Thus, the flow affects the structural displacement, but the pipeline geometry change because of the deformation is assumed to be small and will have no effect on the flow computations.

The flow-induced forces, such as internal overpressure, drag, and junction forces are computed and applied on the structure automatically by the coupling feature.

Later on in the modeling, you add a Heat Transfer in Pipes interface. This interface is based on the assumption that the main mechanism of the heat transfer along the pipe is heat convection due to the fluid flow. Thus, the heat conduction in the pipe walls in the direction along the pipe is neglected. Therefore, only the material representing the fluid is needed for the Heat Transfer in Pipes interface. The same applies to the Pipe Flow

interface. Since both interfaces can take data from an active material with proper selection made under **Materials** in the component, add the fluid material (water in this case) as the last one to avoid overriding.

The Pipe Mechanics interface needs two materials, one for the pipe wall and the other for the contained fluid. The materials are chosen in the node **Fluid and Pipe Materials** under the interface. The material selection lists contain all materials available in the component. The material data are taken from the selected material even if the corresponding material node has no selection or is overridden under **Materials** in the component.

Application Library path: Pipe_Flow_Module/Pipe_Mechanics/
cooling_pipeline_stress



Modeling Instructions

From the **File** menu, choose **New**.

NEW

In the **New** window, click  **Model Wizard**.

MODEL WIZARD

- 1 In the **Model Wizard** window, click  **3D**.
- 2 In the **Select Physics** tree, select **Structural Mechanics > Fluid–Structure Interaction > Fluid–Pipe Interaction, Fixed Geometry**.
- 3 Click **Add**.
- 4 Click  **Study**.
- 5 In the **Select Study** tree, select **General Studies > Stationary**.
- 6 Click  **Done**.

GLOBAL DEFINITIONS

Parameters 1

- 1 In the **Model Builder** window, under **Global Definitions** click **Parameters 1**.
- 2 In the **Settings** window for **Parameters**, locate the **Parameters** section.



3 In the table, enter the following settings:

Name	Expression	Value	Description
d1	10[cm]	0.1 m	Pipe diameter 1
d2	20[cm]	0.2 m	Pipe diameter 2
Q	300[W/m]	300 W/m	Heat source
Text	20[degC]	293.15 K	External temperature
dp	0.5[atm]	50663 Pa	Pressure increase
hpw	3[mm]	0.003 m	Pipe wall thickness



Build the geometry using predefined polygons representing different parts of the pipeline.

GEOMETRY I

Polygon 1 (pol1)



- 1 In the **Geometry** toolbar, click  **More Primitives** and choose **Polygon**.
- 2 In the **Settings** window for **Polygon**, locate the **Coordinates** section.
- 3 Click  **Load from File**.
- 4 Browse to the model's Application Libraries folder and double-click the file `cooling_pipeline_stress_main.txt`.
- 5 Locate the **Selections of Resulting Entities** section. Select the **Resulting objects selection** checkbox.
- 6 Find the **Cumulative selection** subsection. Click **New**.
- 7 In the **New Cumulative Selection** dialog, type `piping_main` in the **Name** text field.
- 8 Click **OK**.

Polygon 2 (pol2)



- 1 In the **Geometry** toolbar, click  **More Primitives** and choose **Polygon**.
- 2 In the **Settings** window for **Polygon**, locate the **Coordinates** section.
- 3 Click  **Load from File**.
- 4 Browse to the model's Application Libraries folder and double-click the file `cooling_pipeline_stress_inlet.txt`.
- 5 Locate the **Selections of Resulting Entities** section. Select the **Resulting objects selection** checkbox.
- 6 Find the **Cumulative selection** subsection. Click **New**.
- 7 In the **New Cumulative Selection** dialog, type `piping_inlet` in the **Name** text field.

8 Click **OK**.

Polygon 3 (pol3)



- 1 In the **Geometry** toolbar, click  **More Primitives** and choose **Polygon**.
- 2 In the **Settings** window for **Polygon**, locate the **Coordinates** section.
- 3 Click  **Load from File**.
- 4 Browse to the model's Application Libraries folder and double-click the file `cooling_pipeline_stress_outlet.txt`.
- 5 Locate the **Selections of Resulting Entities** section. Select the **Resulting objects selection** checkbox.
- 6 Find the **Cumulative selection** subsection. Click **New**.
- 7 In the **New Cumulative Selection** dialog, type `piping_outlet` in the **Name** text field.
- 8 Click **OK**.

Polygon 4 (pol4)

- 1 In the **Geometry** toolbar, click  **More Primitives** and choose **Polygon**.
- 2 In the **Settings** window for **Polygon**, locate the **Coordinates** section.
- 3 Click  **Load from File**.
- 4 Browse to the model's Application Libraries folder and double-click the file `cooling_pipeline_stress_heater.txt`.
- 5 Locate the **Selections of Resulting Entities** section. Select the **Resulting objects selection** checkbox.
- 6 Find the **Cumulative selection** subsection. Click **New**.
- 7 In the **New Cumulative Selection** dialog, type `piping_heater` in the **Name** text field.
- 8 Click **OK**.

Partition certain edges to add points where the pipeline will be mechanically supported.



Partition Edges 1 (pare1)

- 1 In the **Geometry** toolbar, click  **Booleans and Partitions** and choose **Partition Edges**.
- 2 In the **Settings** window for **Partition Edges**, locate the **Edge Selection** section.
- 3 Click the  **Paste Selection** button for **Edges to partition**.
- 4 In the **Paste Selection** dialog, type `p011: 1-3, 6, 32, 33` in the **Selection** text field.
- 5 Click **OK**.
- 6 In the **Settings** window for **Partition Edges**, locate the **Positions** section.

7 In the table, enter the following settings:



Relative arc length parameters
0.25
0.5
0.75

Partition Edges 2 (pare2)

- 1 In the **Geometry** toolbar, click  **Booleans and Partitions** and choose **Partition Edges**.
- 2 In the **Settings** window for **Partition Edges**, locate the **Edge Selection** section.
- 3 Click the  **Paste Selection** button for **Edges to partition**.
- 4 In the **Paste Selection** dialog, type pare1: 7, 8, 11, 20 po13: 3 in the **Selection** text field.
- 5 Click **OK**.
- 6 In the **Settings** window for **Partition Edges**, locate the **Positions** section.
- 7 In the table, enter the following settings:



Relative arc length parameters
1/3
2/3



Partition Edges 3 (pare3)

- 1 In the **Geometry** toolbar, click  **Booleans and Partitions** and choose **Partition Edges**.
- 2 In the **Settings** window for **Partition Edges**, locate the **Edge Selection** section.
- 3 Click the  **Paste Selection** button for **Edges to partition**.
- 4 In the **Paste Selection** dialog, type pare2(1): 12, 16, 23, 29 po12: 3, 4 po14: 3 in the **Selection** text field.
- 5 Click **OK**.

Define a work plane and the corresponding boundary coordinate system to be used in the support definition.

Work Plane 1 (wp1)

- 1 In the **Geometry** toolbar, click  **Work Plane**.
- 2 In the **Settings** window for **Work Plane**, locate the **Plane Definition** section.
- 3 From the **Plane type** list, choose **Vertices**.
- 4 Click the  **Zoom Box** button in the **Graphics** toolbar.

- 5 On the object **pare3(3)**, select Point 2 only.
- 6 Click to select the  **Activate Selection** toggle button for **Second vertex**.
- 7 On the object **pare3(3)**, select Point 25 only.
- 8 Click to select the  **Activate Selection** toggle button for **Third vertex**.
- 9 On the object **pare3(3)**, select Point 1 only.

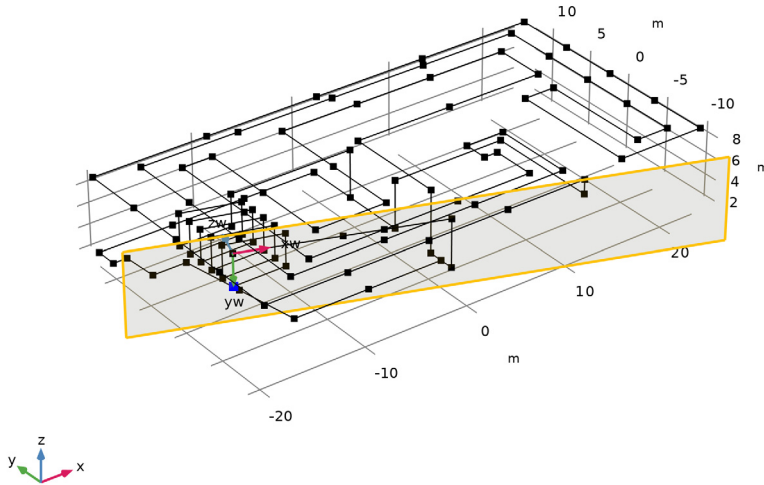

- 10 Click  **Build All Objects**.

DEFINITIONS

System from Geometry 2 (sys2)

- 1 In the **Definitions** toolbar, click  **Coordinate Systems** and choose **System from Geometry**.
- 2 In the **Settings** window for **System from Geometry**, locate the **System from Geometry** section.
- 3 From the **Work plane** list, choose **Work Plane I (wp1)**.

Define variables for the pipe inner diameter for different parts of the pipeline.

Variables 1

- 1 In the **Model Builder** window, right-click **Definitions** and choose **Variables**.

- 2 In the **Settings** window for **Variables**, locate the **Variables** section.
- 3 In the table, enter the following settings:

Name	Expression	Unit	Description
di	d1	m	Inner diameter

- 4 Locate the **Geometric Entity Selection** section. From the **Geometric entity level** list, choose **Edge**.
- 5 From the **Selection** list, choose **pipng_main**.

Variables 2

- 1 Right-click **Variables 1** and choose **Duplicate**.
- 2 In the **Settings** window for **Variables**, locate the **Geometric Entity Selection** section.
- 3 From the **Selection** list, choose **pipng_heater**.

Variables 3

- 1 Right-click **Variables 2** and choose **Duplicate**.
- 2 In the **Settings** window for **Variables**, locate the **Variables** section.
- 3 In the table, enter the following settings:

Name	Expression	Unit	Description
di	d2	m	Inner diameter

- 4 Locate the **Geometric Entity Selection** section. From the **Selection** list, choose **pipng_inlet**.

Variables 4

- 1 Right-click **Variables 3** and choose **Duplicate**.
- 2 In the **Settings** window for **Variables**, locate the **Geometric Entity Selection** section.
- 3 From the **Selection** list, choose **pipng_outlet**.

Variables 1, Variables 2, Variables 3, Variables 4

- 1 In the **Model Builder** window, under **Component 1 (comp1) > Definitions**, Ctrl-click to select **Variables 1**, **Variables 2**, **Variables 3**, and **Variables 4**.
- 2 Right-click and choose **Group**.

Inner Diameter

- 1 In the **Settings** window for **Group**, type Inner Diameter in the **Label** text field.
- 2 In the **Model Builder** window, collapse the **Inner Diameter** node.

Define a maximum operator to be used in the result analysis.

Maximum 1 (maxop1)

- 1 In the **Definitions** toolbar, click  **Nonlocal Couplings** and choose **Maximum**.
- 2 In the **Settings** window for **Maximum**, locate the **Source Selection** section.
- 3 From the **Geometric entity level** list, choose **Edge**.
- 4 From the **Selection** list, choose **All edges**.

The pipe walls are made of structural steel, the fluid inside is water, and the surrounding medium is air. The latter is needed for the specification of the cooling section of the pipeline.

ADD MATERIAL

- 1 In the **Materials** toolbar, click  **Add Material** to open the **Add Material** window.
- 2 Go to the **Add Material** window.
- 3 In the tree, select **Built-in > Structural steel**.
- 4 Right-click and choose **Add to Component 1 (comp1)**.
- 5 In the tree, select **Built-in > Air**.
- 6 Right-click and choose **Add to Component 1 (comp1)**.

MATERIALS

Air (mat2)

- 1 In the **Model Builder** window, under **Component 1 (comp1) > Materials** click **Air (mat2)**.
- 2 In the **Settings** window for **Material**, locate the **Geometric Entity Selection** section.
- 3 From the **Selection** list, choose **piping_main**.

ADD MATERIAL

- 1 Go to the **Add Material** window.
- 2 In the tree, select **Built-in > Water, liquid**.
- 3 Right-click and choose **Add to Component 1 (comp1)**.
- 4 In the **Materials** toolbar, click  **Add Material** to close the **Add Material** window.

MATERIALS

Water, liquid (mat3)

- 1 In the **Settings** window for **Material**, locate the **Geometric Entity Selection** section.

- 2 From the **Selection** list, choose **All edges**.

PIPE FLOW (PFL)

Fluid Properties I

- 1 In the **Model Builder** window, under **Component 1 (comp1) > Pipe Flow (pfl)** click **Fluid Properties I**.
- 2 In the **Settings** window for **Fluid Properties**, locate the **Model Input** section.
- 3 In the T text field, type 50[degC].

Pipe Properties I

- 1 In the **Model Builder** window, click **Pipe Properties I**.
- 2 In the **Settings** window for **Pipe Properties**, locate the **Pipe Shape** section.
- 3 From the list, choose **Circular**.
- 4 In the d_i text field, type di.
- 5 Locate the **Flow Resistance** section. From the **Surface roughness** list, choose **Commercial steel (0.046 mm)**.

PIPE MECHANICS (PIPEM)

Fluid and Pipe Materials I

- 1 In the **Model Builder** window, under **Component 1 (comp1) > Pipe Mechanics (pipem)** click **Fluid and Pipe Materials I**.
- 2 In the **Settings** window for **Fluid and Pipe Materials**, locate the **Pipe Properties** section.
- 3 From the **Pipe material** list, choose **Structural steel (mat1)**.

Pipe Cross Section I

- 1 In the **Model Builder** window, click **Pipe Cross Section I**.
- 2 In the **Settings** window for **Pipe Cross Section**, locate the **Pipe Shape** section.
- 3 From the list, choose **Circular**.
- 4 In the d_i text field, type di.
- 5 In the d_o text field, type di+hpw.

Add the gravity force acting on the fluid. Note that the force defined here will only be accounted for when computing the flow in the pipeline.

PIPE FLOW (PFL)

In the **Model Builder** window, under **Component 1 (comp1)** click **Pipe Flow (pfl)**.

Volume Force 1

- 1 In the **Physics** toolbar, click  **Edges** and choose **Volume Force**.
- 2 In the **Settings** window for **Volume Force**, locate the **Edge Selection** section.
- 3 From the **Selection** list, choose **All edges**.

Add a pump node and define the pressure increase at its selected location.

Pump 1

- 1 In the **Physics** toolbar, click  **Points** and choose **Pump**.
- 2 Select Point 9 only.
- 3 In the **Settings** window for **Pump**, locate the **Pump Specification** section.
- 4 From the **Type** list, choose **Pressure increase**.
- 5 In the Δp text field, type dp.

Define the reference pressure.

Internal Pressure Lock 1



- 1 In the **Physics** toolbar, click  **Points** and choose **Internal Pressure Lock**.
- 2 Select Point 8 only.

Define two T-junctions in the pipeline.

T-Junction 1

- 1 In the **Physics** toolbar, click  **Points** and choose **T-Junction**.
- 2 In the **Settings** window for **T-Junction**, locate the **Selection Settings** section.
- 3 Clear the **Manual control of selections** checkbox.

Bend 1

- 1 In the **Physics** toolbar, click  **Points** and choose **Bend**.
- 2 In the **Settings** window for **Bend**, locate the **Point Selection** section.
- 3 Click  **Paste Selection**.
- 4 In the **Paste Selection** dialog, type 1-3, 7, 10-22, 25, 26, 28, 30, 32, 34-46, 48, 57, 59-61, 63-67, 69, 70, 77-80, 82-86, 90-96, 100, 101, 105 in the **Selection** text field.

5 Click **OK**.

This selection corresponds to all geometry turns except those used in the setup of the three previous nodes.

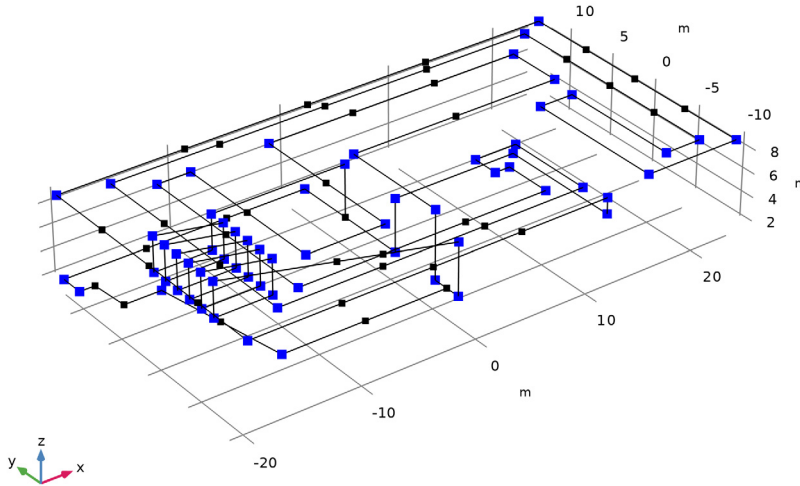

Initial Values 1

- 1 In the **Model Builder** window, click **Initial Values 1**.
- 2 In the **Settings** window for **Initial Values**, locate the **Initial Values** section.
- 3 In the u_{fluid} text field, type -1.

Next, add the gravity force acting on the pipeline. The weights of both the pipe walls and the containing fluid will be taken into account in the force computations.

PIPE MECHANICS (PIPEM)

In the **Model Builder** window, under **Component 1 (comp1)** click **Pipe Mechanics (pipem)**.

Gravity 1



In the **Physics** toolbar, click  **Global** and choose **Gravity**.

Fixed Constraint 1

- 1 In the **Physics** toolbar, click  **Points** and choose **Fixed Constraint**.
- 2 Select Point 8 only.

Define other mechanical constraints applied to the pipeline by using unidirectional supports.

Prescribed Displacement/Rotation I

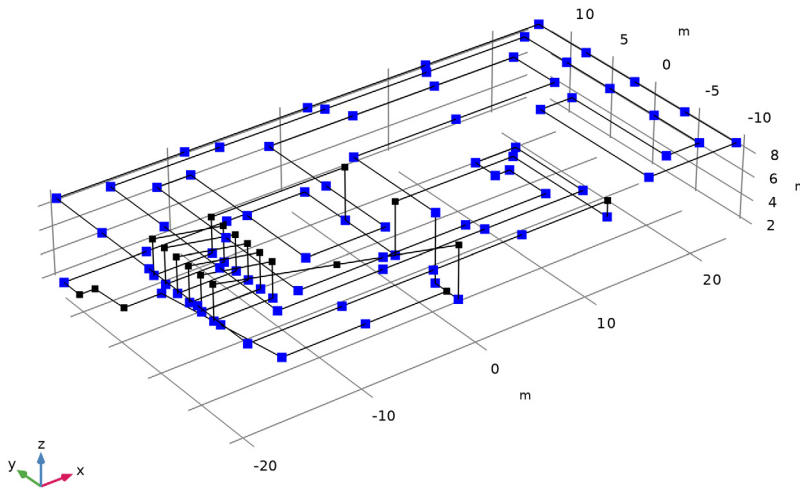

- 1 In the **Physics** toolbar, click  **Points** and choose **Prescribed Displacement/Rotation**.
- 2 In the **Settings** window for **Prescribed Displacement/Rotation**, locate the **Point Selection** section.
- 3 Click  **Paste Selection**.
- 4 In the **Paste Selection** dialog, type 2-7, 10, 12, 14, 16, 18, 20, 22-34, 36, 38, 40, 42, 44, 46-49, 51-60, 63-65, 67, 68, 70-84, 86-105 in the **Selection** text field.
- 5 Click **OK**.



At these locations, the pipeline is supported, which will constrain its downward motion.

- 6 In the **Settings** window for **Prescribed Displacement/Rotation**, locate the **Prescribed Displacement** section.
- 7 From the **Displacement in z direction** list, choose **Limited**.
- 8 In the $u_{0z,\min}$ text field, type 0.

Prescribed Displacement/Rotation 2

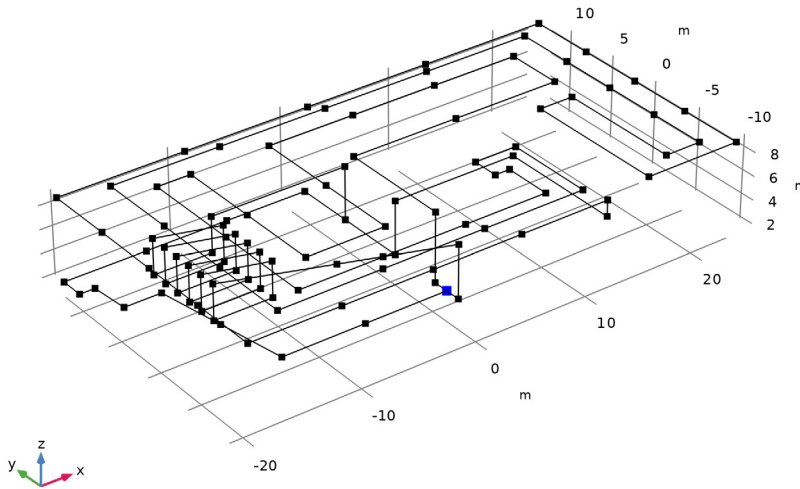

- 1 In the **Physics** toolbar, click  **Points** and choose **Prescribed Displacement/Rotation**.
- 2 In the **Settings** window for **Prescribed Displacement/Rotation**, locate the **Point Selection** section.
- 3 Click  **Paste Selection**.
- 4 In the **Paste Selection** dialog, type 62 in the **Selection** text field.
- 5 Click **OK**.



Here, possible horizontal motion of the T-junction will be restricted.

- 6 In the **Settings** window for **Prescribed Displacement/Rotation**, locate the **Prescribed Displacement** section.
- 7 From the **Displacement in x direction** list, choose **Limited**.
- 8 In the $u_{0x,max}$ text field, type 0.01.

Prescribed Displacement/Rotation 3

- 1 In the **Physics** toolbar, click  **Points** and choose **Prescribed Displacement/Rotation**.
- 2 In the **Settings** window for **Prescribed Displacement/Rotation**, locate the **Point Selection** section.
- 3 Click  **Paste Selection**.

- 4 In the **Paste Selection** dialog, type 50 in the **Selection** text field.
- 5 Click **OK**.

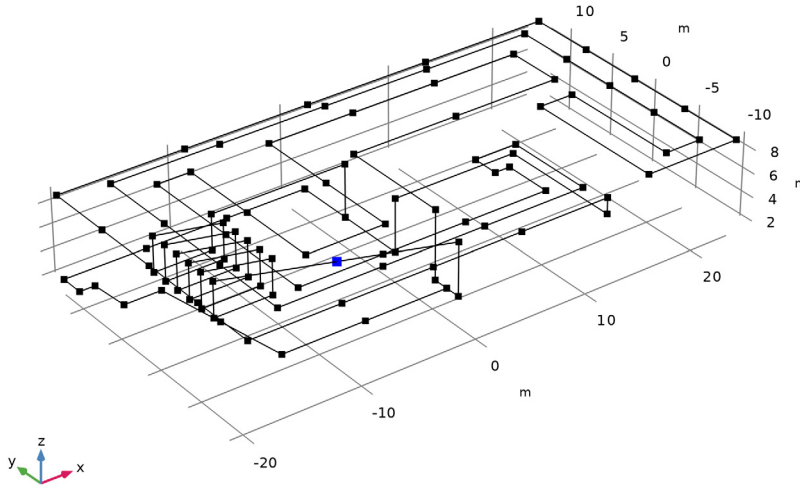

At this location, possible swaying of the pipe will be restricted.

- 6 In the **Settings** window for **Prescribed Displacement/Rotation**, locate the **Coordinate System Selection** section.
- 7 From the **Coordinate system** list, choose **System from Geometry 2 (sys2)**.
- 8 Locate the **Prescribed Displacement** section. From the **Displacement in x2 direction** list, choose **Limited**.
- 9 In the $u_{0x2,max}$ text field, type 0.
- 10 From the **Displacement in x3 direction** list, choose **Limited**.
- 11 In the $u_{0x3,max}$ text field, type 0.01.
- 12 In the $u_{0x3,min}$ text field, type -0.01.



Before adding a Heat Transfer interface, generate a solver sequence. The Pipe Flow and Pipe Mechanics interfaces added so far to the model are unidirectionally coupled. Thus, the flow will affect the structural displacement, but not vice versa. The autogenerated solver sequence will use a segregated solver with two groups, where the fluid flow and structural displacement are computed consecutively.

STUDY 1

Solution 1 (sol1)

In the **Study** toolbar, click  **Show Default Solver**.

ADD PHYSICS

- 1 In the **Home** toolbar, click  **Add Physics** to open the **Add Physics** window.
- 2 Go to the **Add Physics** window.
- 3 In the tree, select **Heat Transfer** > **Heat Transfer in Pipes (htp)**.
- 4 Click the **Add to Component 1** button in the window toolbar.
- 5 In the **Home** toolbar, click  **Add Physics** to close the **Add Physics** window.

HEAT TRANSFER IN PIPES (HTP)



Heat Transfer 1

- 1 In the **Settings** window for **Heat Transfer**, locate the **Heat Convection and Conduction** section.
- 2 From the u list, choose **Tangential velocity (pfl)**.

Pipe Properties 1

- 1 In the **Model Builder** window, click **Pipe Properties 1**.
- 2 In the **Settings** window for **Pipe Properties**, locate the **Pipe Shape** section.
- 3 From the list, choose **Circular**.
- 4 In the d_i text field, type d_i .
- 5 Locate the **Flow Resistance** section. From the **Surface roughness** list, choose **Commercial steel (0.046 mm)**.

Heat Source 1

- 1 In the **Physics** toolbar, click  **Edges** and choose **Heat Source**.
Specify the heat source location and intensity.
- 2 In the **Settings** window for **Heat Source**, locate the **Edge Selection** section.
- 3 Click  **Paste Selection**.
- 4 In the **Paste Selection** dialog, type 12, 13, 15-29, 44-49 in the **Selection** text field.

5 Click **OK**.

This selection corresponds to the inner spiral part of the geometry.

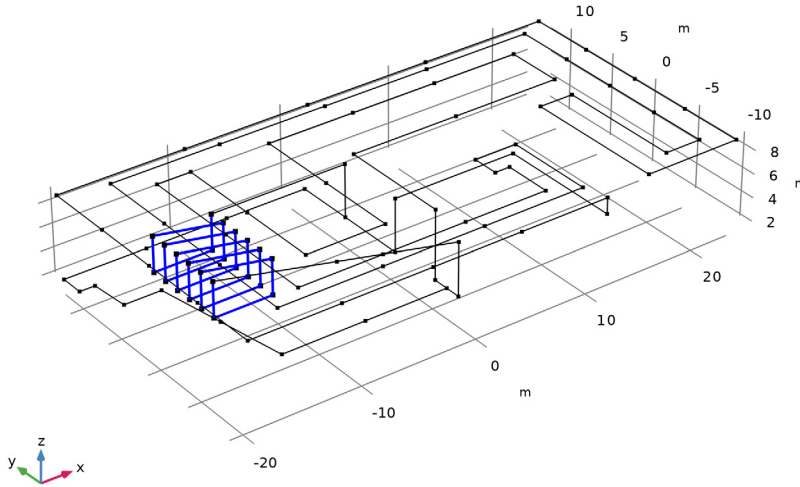

6 In the **Settings** window for **Heat Source**, locate the **Heat Source** section.

7 In the Q_0 text field, type Q.

Wall Heat Transfer I

1 In the **Physics** toolbar, click  **Edges** and choose **Wall Heat Transfer**.

Define the top part of the pipeline, which is cooled by the surrounding air.

2 In the **Settings** window for **Wall Heat Transfer**, locate the **Edge Selection** section.

3 Click  **Paste Selection**.

4 In the **Paste Selection** dialog, type 4-9, 30-34, 39-43, 51-54, 56, 59-64, 69, 73, 76-87, 90-106 in the **Selection** text field.

5 Click **OK**.

This selection corresponds to the top part of the geometry.

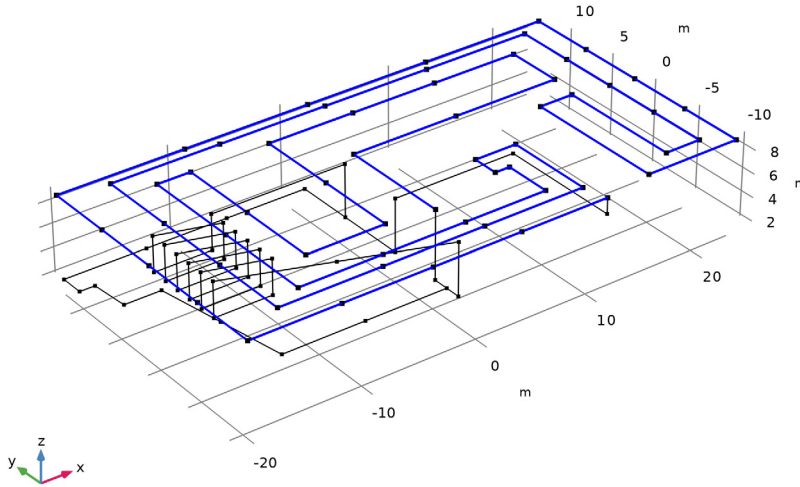

6 In the **Settings** window for **Wall Heat Transfer**, locate the **Heat Transfer Model** section.

7 In the T_{ext} text field, type Text.

Internal Film Resistance I

In the **Physics** toolbar, click  **Attributes** and choose **Internal Film Resistance**.

Wall Heat Transfer I

In the **Model Builder** window, click **Wall Heat Transfer I**.

External Film Resistance I

1 In the **Physics** toolbar, click  **Attributes** and choose **External Film Resistance**.

2 In the **Settings** window for **External Film Resistance**, locate the **Specification** section.

3 From the **External film heat transfer model** list, choose **External natural convection**.

4 From the **Surrounding fluid** list, choose **Air (mat2)**.

Specify the thermal expansion of the pipe walls caused by the temperature increase and variation.

PIPE MECHANICS (PIPEM)

Fluid and Pipe Materials I

In the **Model Builder** window, under **Component 1 (comp1) > Pipe Mechanics (pipem)** click **Fluid and Pipe Materials 1**.

Thermal Expansion I

- 1 In the **Physics** toolbar, click  **Attributes** and choose **Thermal Expansion**.
- 2 In the **Settings** window for **Thermal Expansion**, locate the **Model Input** section.
- 3 From the T list, choose **Temperature (htp)**.
- 4 From the T_{ref} list, choose **User defined**. In the associated text field, type Text.

Update the dependent variables in the solver, which will create a new segregated group for the variables added by the Heat Transfer interface.

STUDY 1

Solution 1 (sol1)

- 1 In the **Model Builder** window, expand the **Study 1 > Solver Configurations > Solution 1 (sol1)** node.
- 2 Right-click **Study 1 > Solver Configurations > Solution 1 (sol1) > Dependent Variables 1** and choose **Update Variables**.
- 3 In the **Model Builder** window, expand the **Study 1 > Solver Configurations > Solution 1 (sol1) > Stationary Solver 1** node.
Configure the solver settings for the new segregated group to be similar to those for the two other groups.
- 4 In the **Model Builder** window, expand the **Study 1 > Solver Configurations > Solution 1 (sol1) > Stationary Solver 1 > Segregated 1** node, then click **Segregated Step 1**.
- 5 In the **Settings** window for **Segregated Step**, type Heat in the **Label** text field.
- 6 Click to expand the **Method and Termination** section. From the **Nonlinear method** list, choose **Automatic (Newton)**.
- 7 In the **Tolerance factor** text field, type 1.
- 8 In the **Maximum number of iterations** text field, type 50.

Move the group up so that the heat-transfer problem is solved after the flow computation but before the structural-displacement calculation.



- 9 Right-click **Study 1** > **Solver Configurations** > **Solution 1 (sol1)** > **Stationary Solver 1** > **Segregated 1** > **Heat** and choose **Move Up**.

Prepare a plot to be shown during the parametric-sweep computation.

- 10 In the **Study** toolbar, click  **Show Default Plots**.

RESULTS

Preferred Units 1

- 1 In the **Results** toolbar, click  **Configurations** and choose **Preferred Units**.
- 2 In the **Settings** window for **Preferred Units**, locate the **Units** section.
- 3 Click  **Add Physical Quantity**.
- 4 In the **Physical Quantity** dialog, select **Solid Mechanics** > **Stress tensor (N/m²)** in the tree.
- 5 Click **OK**.
- 6 In the **Settings** window for **Preferred Units**, locate the **Units** section.
- 7 In the table, enter the following settings:

Quantity	Unit	Preferred unit
Stress tensor	N/m ²	MPa

- 8 Click  **Add Physical Quantity**.
- 9 In the **Physical Quantity** dialog, select **General** > **Temperature (K)** in the tree.
- 10 Click **OK**.
- 11 In the **Settings** window for **Preferred Units**, locate the **Units** section.
- 12 In the table, enter the following settings:

Quantity	Unit	Preferred unit
Temperature	K	°C

- 13 Select the **Apply conversions to expressions with the same dimensions** checkbox.
- 14 Click  **Apply**.

Line 1

- 1 In the **Model Builder** window, expand the **Results** > **Temperature (htp)** node, then click **Line 1**.
- 2 In the **Settings** window for **Line**, locate the **Coloring and Style** section.
- 3 Select the **Radius scale factor** checkbox. In the associated text field, type 3.

STUDY I

Step 1: Stationary

- 1 In the **Model Builder** window, under **Study I** click **Step 1: Stationary**.
- 2 In the **Settings** window for **Stationary**, click to expand the **Results While Solving** section.
- 3 Select the **Plot** checkbox.
- 4 In the table, enter the following settings:

Plot group	Plot window
Temperature (htp)	Graphics

The pressure increase at the pump will gradually decrease from 2 atm down to 0.25 atm.

- 5 Click to expand the **Study Extensions** section. Select the **Auxiliary sweep** checkbox.
- 6 Click **+ Add**.
- 7 In the table, enter the following settings:

Parameter name	Parameter value list	Parameter unit
dp (Pressure increase)	range(2, -0.25, 0.25)	atm

- 8 In the **Study** toolbar, click **= Compute**.

RESULTS

Pressure (pfl)

Plot the maximum values of the temperature and the von Mises stress reached along the pipeline for all computed values of the pressure increase.

Maximum Temperature

- 1 In the **Results** toolbar, click **~ ID Plot Group**.
- 2 In the **Settings** window for **ID Plot Group**, type Maximum Temperature in the **Label** text field.
- 3 Locate the **Legend** section. Clear the **Show legends** checkbox.

Global 1

- 1 Right-click **Maximum Temperature** and choose **Global**.
- 2 In the **Settings** window for **Global**, locate the **y-Axis Data** section.

3 In the table, enter the following settings:

Expression	Unit	Description
maxop1(T)	°C	Maximum temperature

4 In the **Maximum Temperature** toolbar, click  **Plot**.

Maximum von Mises Stress

1 In the **Model Builder** window, right-click **Maximum Temperature** and choose **Duplicate**.

2 In the **Settings** window for **ID Plot Group**, type Maximum von Mises Stress in the **Label** text field.

Global 1

1 In the **Model Builder** window, expand the **Maximum von Mises Stress** node, then click **Global 1**.

2 In the **Settings** window for **Global**, locate the **y-Axis Data** section.

3 In the table, enter the following settings:

Expression	Unit	Description
maxop1(pipem.mises)	MPa	Maximum von Mises stress

4 In the **Maximum von Mises Stress** toolbar, click  **Plot**.

The plots should be similar to those shown in [Figure 3](#) and [Figure 4](#). They show that both quantities reaches their local minimum value for the pressure increase of 0.5 atm.

Update the default plots to select this value of dp parameter.

Pressure (pfl)

1 In the **Model Builder** window, under **Results** click **Pressure (pfl)**.

2 In the **Settings** window for **3D Plot Group**, locate the **Data** section.

3 From the **Parameter value (dp (atm))** list, choose **0.5**.

Line 1

1 In the **Model Builder** window, expand the **Pressure (pfl)** node, then click **Line 1**.

2 In the **Settings** window for **Line**, locate the **Expression** section.

3 From the **Unit** list, choose **atm**.

4 Locate the **Coloring and Style** section.

5 Select the **Radius scale factor** checkbox. In the associated text field, type 3.

6 In the **Pressure (pfl)** toolbar, click  **Plot**.

Velocity (pfl)

- 1 In the **Model Builder** window, under **Results** click **Velocity (pfl)**.
- 2 In the **Settings** window for **3D Plot Group**, locate the **Data** section.
- 3 From the **Parameter value (dp (atm))** list, choose **0.5**.

Arrow Line 1

- 1 In the **Model Builder** window, expand the **Velocity (pfl)** node, then click **Arrow Line 1**.
- 2 In the **Settings** window for **Arrow Line**, locate the **Arrow Positioning** section.
- 3 In the **Number of arrows** text field, type 80.
- 4 Locate the **Coloring and Style** section. From the **Arrow type** list, choose **Cone**.
- 5 From the **Arrow base** list, choose **Center**.
- 6 Select the **Scale factor** checkbox. In the associated text field, type 2.
- 7 In the **Velocity (pfl)** toolbar, click  **Plot**.

Stress (pipem)

- 1 In the **Model Builder** window, under **Results** click **Stress (pipem)**.
- 2 In the **Settings** window for **3D Plot Group**, locate the **Data** section.
- 3 From the **Parameter value (dp (atm))** list, choose **0.5**.

Line 1

- 1 In the **Model Builder** window, expand the **Stress (pipem)** node, then click **Line 1**.
- 2 In the **Settings** window for **Line**, locate the **Coloring and Style** section.
- 3 In the **Radius scale factor** text field, type 3.



Deformation

- 1 In the **Model Builder** window, expand the **Line 1** node, then click **Deformation**.
- 2 In the **Settings** window for **Deformation**, locate the **Scale** section.
- 3 Select the **Scale factor** checkbox. In the associated text field, type 1.
- 4 In the **Stress (pipem)** toolbar, click  **Plot**.

Temperature (htp)

- 1 In the **Model Builder** window, under **Results** click **Temperature (htp)**.
- 2 In the **Settings** window for **3D Plot Group**, locate the **Data** section.
- 3 From the **Parameter value (dp (atm))** list, choose **0.5**.
- 4 In the **Temperature (htp)** toolbar, click  **Plot**.

RESULT TEMPLATES

- 1 In the **Results** toolbar, click  **Result Templates** to open the **Result Templates** window.
- 2 Go to the **Result Templates** window.
- 3 In the tree, select **Study 1/Solution 1 (sol1) > Pipe Mechanics > Section Forces (pipem) > Total Bending Moment (pipem)**.
- 4 Click the **Add Result Template** button in the window toolbar.
- 5 In the **Results** toolbar, click  **Result Templates** to close the **Result Templates** window.

RESULTS

Total Bending Moment (pipem)

- 1 In the **Settings** window for **3D Plot Group**, locate the **Data** section.
- 2 From the **Parameter value (dp (atm))** list, choose **0.5**.



Line 1

- 1 In the **Model Builder** window, expand the **Total Bending Moment (pipem)** node, then click **Line 1**.
- 2 In the **Settings** window for **Line**, locate the **Expression** section.
- 3 From the **Unit** list, choose **kN*m**.
- 4 Locate the **Coloring and Style** section. In the **Radius scale factor** text field, type **3**.

Deformation

- 1 In the **Model Builder** window, expand the **Line 1** node, then click **Deformation**.
- 2 In the **Settings** window for **Deformation**, locate the **Scale** section.
- 3 Select the **Scale factor** checkbox. In the associated text field, type **1**.
- 4 In the **Total Bending Moment (pipem)** toolbar, click  **Plot**.

RESULT TEMPLATES

- 1 In the **Results** toolbar, click  **Result Templates** to open the **Result Templates** window.
- 2 Go to the **Result Templates** window.
- 3 In the tree, select **Study 1/Solution 1 (sol1) > Pipe Mechanics > Section Forces (pipem) > Total Shear Force (pipem)**.
- 4 Click the **Add Result Template** button in the window toolbar.
- 5 In the **Results** toolbar, click  **Result Templates** to close the **Result Templates** window.

RESULTS

Total Shear Force (pipem)

- 1 In the **Settings** window for **3D Plot Group**, locate the **Data** section.
- 2 From the **Parameter value (dp (atm))** list, choose **0.5**.

Line 1



- 1 In the **Model Builder** window, expand the **Total Shear Force (pipem)** node, then click **Line 1**.
- 2 In the **Settings** window for **Line**, locate the **Expression** section.
- 3 From the **Unit** list, choose **kN**.
- 4 Locate the **Coloring and Style** section. In the **Radius scale factor** text field, type 3.

Deformation

- 1 In the **Model Builder** window, expand the **Line 1** node, then click **Deformation**.
- 2 In the **Settings** window for **Deformation**, locate the **Scale** section.
- 3 Select the **Scale factor** checkbox. In the associated text field, type 1.
- 4 In the **Total Shear Force (pipem)** toolbar, click  **Plot**.

Plot a detailed stress distribution in the pipe section near the pump using a special Pipe dataset.

RESULT TEMPLATES

- 1 In the **Results** toolbar, click  **Result Templates** to open the **Result Templates** window.
- 2 Go to the **Result Templates** window.
- 3 In the tree, select **Study 1/Solution 1 (sol1) > Pipe Mechanics > Stress, 3D (pipem)**.
- 4 Click the **Add Result Template** button in the window toolbar.
- 5 In the **Results** toolbar, click  **Result Templates** to close the **Result Templates** window.

RESULTS

Pipe



In the **Model Builder** window, expand the **Results > Datasets** node, then click **Pipe**.

Selection

- 1 In the **Results** toolbar, click  **Attributes** and choose **Selection**.
- 2 In the **Settings** window for **Selection**, locate the **Edge Selection** section.
- 3 From the **Geometric entity level** list, choose **Edge**.

4 Select Edge 11 only.

Stress, 3D (pipem)

- 1 In the **Model Builder** window, under **Results** click **Stress, 3D (pipem)**.
- 2 In the **Settings** window for **3D Plot Group**, locate the **Plot Settings** section.
- 3 From the **View** list, choose **New view** to generate a dedicated view for this plot.
- 4 In the **Stress, 3D (pipem)** toolbar, click  **Plot**.
- 5 Click the  **Zoom Extents** button in the **Graphics** toolbar.
- 6 Click  **Go to Source**.

Section View

- 1 In the **Model Builder** window, under **Results > Views** click **View 3D 3**.
- 2 In the **Settings** window for **View 3D**, type Section View in the **Label** text field.