



Model created in COMSOL Multiphysics 6.4

Acoustics of a Pipe System with 3D Bend and Junction

Introduction

The propagation and response of acoustic signals in pipe systems is used to detect leaks and deformations in the pipes. This is, for example, relevant in the oil and gas industry or in water delivery piping systems. This model uses the pipe acoustics interfaces to model the propagation of acoustic waves in a pipe system using a 1D model. The 1D model is coupled to a detailed 3D model of a junction and a bend. In the 3D domains, a pressure acoustics interface is used. The 3D domains could represent any complex geometry like valves, reservoirs, or pipe expansions where the 1D model is not valid. The tutorial sets up both a transient and a frequency-domain version of the model. A Pressure Acoustics, Boundary Mode interface is used to compute and analyze the propagating modes in the pipe cross section, as only plane propagating modes are supported in the 1D pipe formulation.

Note: The model requires the Acoustics Module.

Model Definition

Pipe acoustics is used to model the propagation and response of acoustic signals in the long pipe segments using a 1D model. This interface is only valid for the analysis of plane wave modes. The 3D structures are modeled using pressure acoustics. To ensure correct coupling to the 1D model, the Acoustics–Pipe Acoustics Connection multiphysics coupling is used. The coupling requires a straight pipe segment connected to the 3D structure and it is only valid when the background fluid velocity is zero.

For a given pipe system in quiescent conditions ($\mathbf{u}_0 = 0$), constant background pressure, and completely rigid walls, the governing equations of the pipe system become:

$$\rho A \frac{\partial u}{\partial t} = -A(\nabla_t p \cdot \mathbf{e}_t) - \tau_w Z + A \mathbf{F} \cdot \mathbf{e}_t \quad (1)$$

$$\frac{A}{c^2} \frac{\partial p}{\partial t} + \nabla_t (A \rho u) \cdot \mathbf{e}_t = 0 \quad (2)$$

where ρ is the fluid density, A is the cross-sectional area of the pipe, \mathbf{u} is the area-averaged acoustic velocity, which is defined in the tangential direction $\mathbf{u} = u \mathbf{e}_t$, where \mathbf{e}_t is the tangential vector, ∇_t is the tangential derivative, τ_w is the tangential wall drag force, Z is the inner perimeter of the pipe, \mathbf{F} is a volume force applied to the pipe, and c is the

effective speed of sound in the pipe (in a rigid pipe this has the same value as the isentropic bulk speed of sound).

The pipe acoustics domain (pipe domain) is connected to the pressure acoustics domain (acoustic domain) through the Acoustics–Pipe Acoustics Connection multiphysics coupling. This coupling guarantees continuity of pressure and velocity between both domains through the equations:

$$p_{\text{pipe}} = \frac{1}{A} \int p_t dS \quad (3)$$

$$-\mathbf{n} \cdot \left(-\frac{1}{\rho} (\nabla p_t - \mathbf{q}_d) \right) = \frac{\partial u_{\text{pipe}}}{\partial t} \quad (4)$$

Here, p_{pipe} is the pipe pressure at the connection point, A is the total area of the connected acoustic boundary, p_t is the total pressure in the acoustic domain and S is the connected acoustic boundary, \mathbf{n} is the vector normal to the boundary, and u_{pipe} is the pipe velocity at the connection point. The possible dipole domain source, \mathbf{q}_d , is zero in this model.

The geometry of the pipe system, including both 1D and 3D domains, is shown in [Figure 1](#).

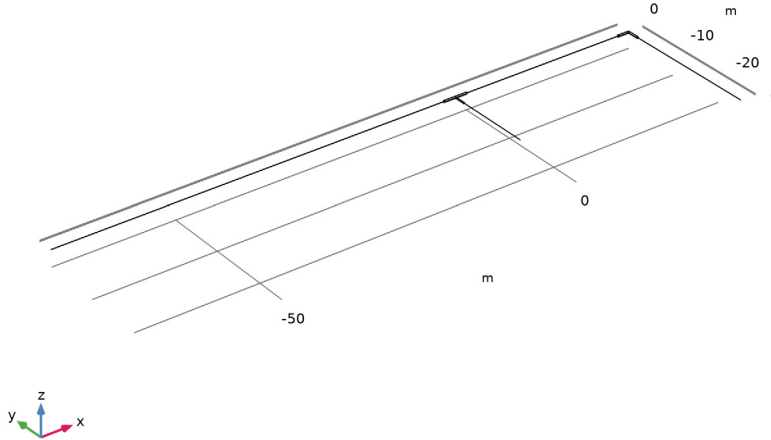

Figure 1: Model geometry.

The model has two separated 3D domains, shown in [Figure 2](#), which will be included in the model using the Pressure Acoustics interface.

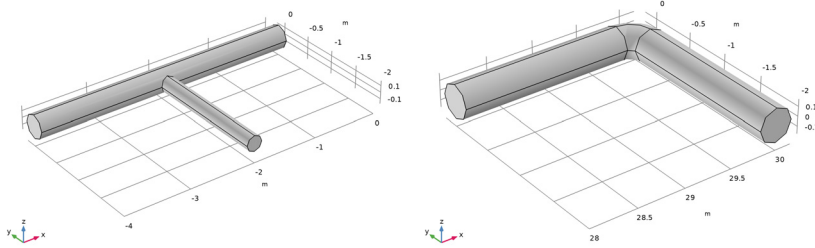

Figure 2: T-junction and bend.

The pipe ends, not connected to the Pressure Acoustics domains, have an end impedance condition of an infinite pipe, allowing the acoustic waves to exit the system. In our case, this simply corresponds to the characteristic specific impedance.

$$Z_{\text{end}} = c\rho \quad (5)$$

The points where this impedance condition is imposed can be seen in [Figure 3](#).

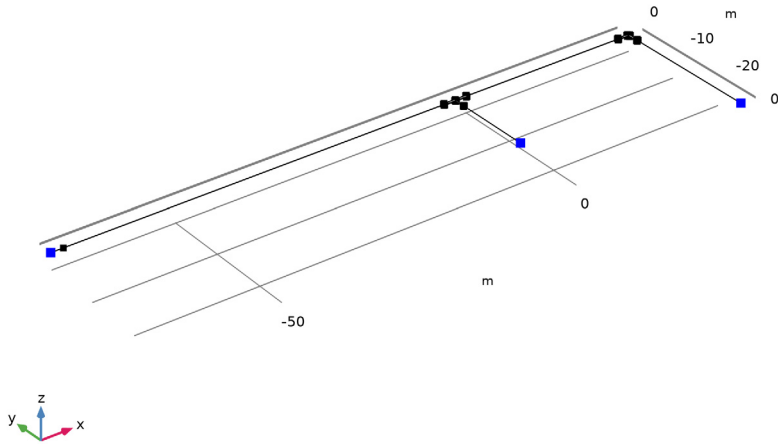

Figure 3: The pipe end impedance conditions are applied to the open ends of the pipe system.

The tutorial sets up both a transient and a frequency domain version of the model. Under the transient analysis, a wave train is created through the imposition of a volume force on one end of the pipe system. The force is defined through an analytical function created under the **Definitions** node. [Figure 4](#) shows a plot of the analytical function used in the model to generate the wave train.

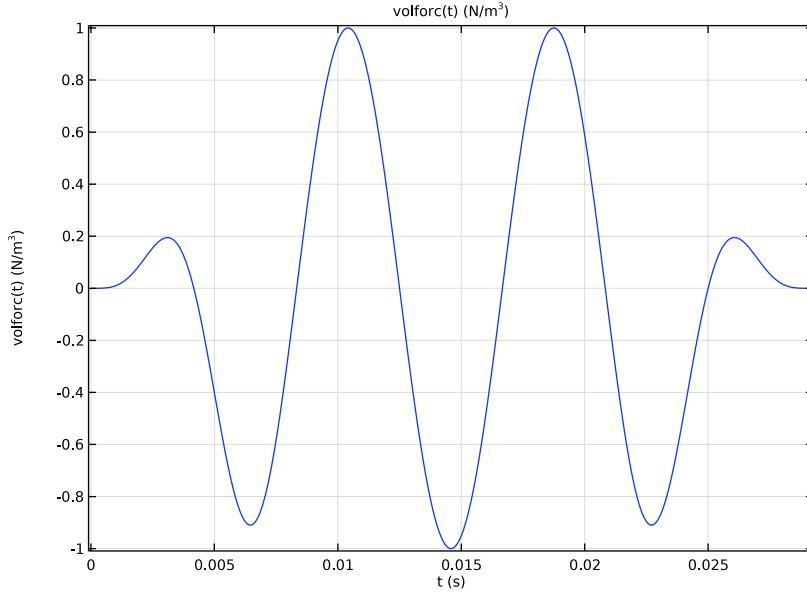

Figure 4: Imposed volume force as direct output of the plot functionality when defining an analytic function.

At last, a Pressure Acoustics, Boundary Mode interface is used to solve for the propagation modes on the pipe cross section at the driving frequency to check if higher order modes can propagate. This is easy and quick to check by solving an eigenvalue problem. The eigenvalue solver computes a specified number of solutions $\{p_j, \lambda_j\}$ to the equation

$$-\frac{1}{\rho}\nabla^2 p_t - \frac{k_{\text{eq}}^2}{\rho} p_t = 0 \quad (6)$$

with

$$p_t = p, \quad k_{\text{eq}}^2 = \left(\frac{\omega}{c}\right)^2 - k_n^2, \quad -ik_n = \lambda \quad (7)$$

where p_t is the total pressure, k_{eq} is the in-plane wave number, ω is the angular frequency, k_n is the out-of-plane wave number, and $\lambda = -ik_n$ is the eigenvalue.

Results and Discussion

Figure 5 shows the transient pressure distribution in the pipe system at various times. The figure shows the continuity in the pressure at the Acoustics–Pipe Acoustics Connection points.

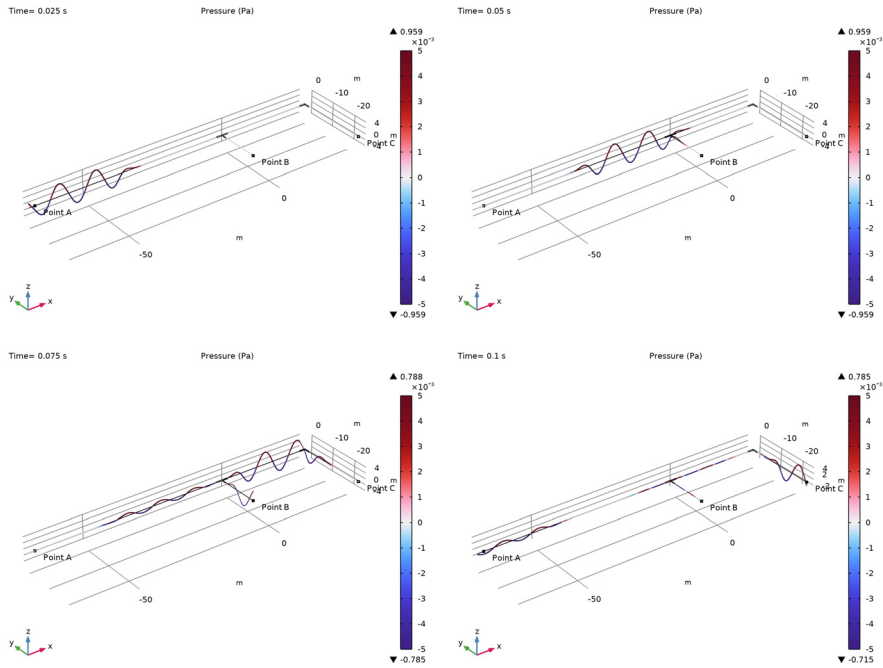

Figure 5: Evolution of the Pressure in the pipe system at various times.

The initial wave train travels through the pipe system producing reflections as the wave finds discontinuities at the T-junction and the bend. Figure 6 shows the pressure at different points of the pipe system. The reflected wave from the T-junction can be observed in Point A after 0.09 s and the reflected wave coming from the pipe bend can be

seen after 0.13 s. By updating the parameter `rbend`, that controls the bending radius of the bend, to 160 cm this reflection can be greatly reduced.

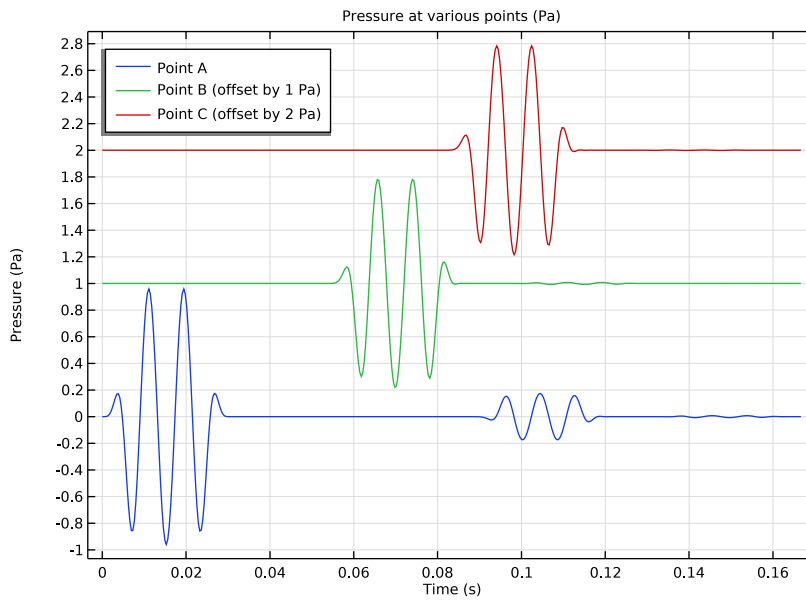

Figure 6: Pressure at three points in the pipe system (Point B and Point C are offset on the y-axis for clarity).

This model can be updated to consider the compressibility of the pipe section based on the elastic modulus and thickness of the pipe wall. Analyzing the pipe system response in the time domain allows us to easily identify reflections or changes in the acoustic response caused by changes in pipe section or wall thickness and these changes can be linked to corrosion or leaks in the pipe system.

The problem can be solved in the frequency domain; the results will be equivalent to exciting the system in the time domain with a sine wave until you reach steady state. By solving the model in the frequency domain, a quick and inexpensive computation, insight

into the pressure distribution for a given input can be obtained. Figure 7 shows the response of the pipe system under an excitation with a frequency of 120 Hz.

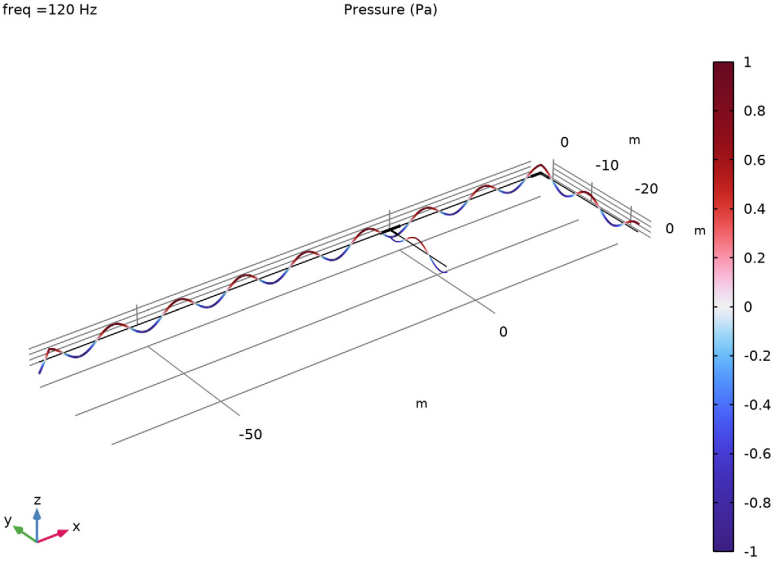

Figure 7: Pressure distribution in the frequency domain at 120 Hz.

The Pressure Acoustics, Boundary Mode interface solves for the propagating and nonpropagating modes on the pipe cross section at the driving frequency to check if higher order modes propagate at the given frequency or if it is just the plane wave component. A mode with a real wave number will propagate, while a mode with imaginary wave number will not be able to propagate. Figure 8 shows the pressure distribution and the wave

number for the propagating plane wave (left) and the nonpropagating mode (2,0) (right) at 120 Hz.

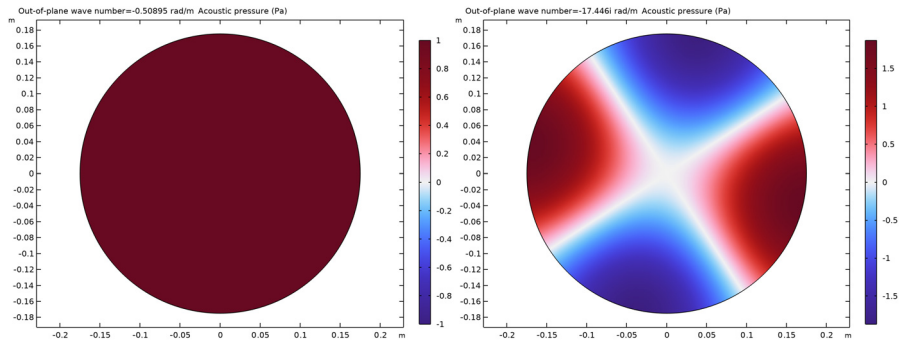

Figure 8: Pressure distribution for the propagating mode (0, 0) (left) and nonpropagating mode (2,0) (right) at 120 Hz.

This tutorial presents an introduction to the modeling of pipe systems and a selection of the different analysis techniques that can be applied to them. Further details like the compressibility of the pipes or more complex 3D domains can be added to increase the fidelity of the model.

Application Library path: Pipe_Flow_Module/Pipe_Acoustics/
acoustics_pipe_system

Modeling Instructions

From the **File** menu, choose **New**.

NEW

In the **New** window, click  **Model Wizard**.

MODEL WIZARD

1 In the **Model Wizard** window, click .

2 Click  **Done**.

GEOMETRY I

Import a fully parametric sequence that defines the geometry of the model. The parameters used to define the geometry can be modified and updated at any point of the tutorial. Detailed instructions for setting up the geometry are found at the appendix at the end of the instructions.

- 1 In the **Geometry** toolbar, click **Insert Sequence** and choose **Insert Sequence**.
- 2 Browse to the model's Application Libraries folder and double-click the file `acoustics_pipe_system_geom_sequence.mph`.
- 3 In the **Geometry** toolbar, click  **Build All**.



The image should look like that in [Figure 1](#).

GLOBAL DEFINITIONS

Geometry

- 1 In the **Model Builder** window, under **Global Definitions** click **Parameters I**.
- 2 In the **Settings** window for **Parameters**, type Geometry in the **Label** text field.
This group includes all the parameters that define the geometry of the model.

Model Parameters

- 1 In the **Home** toolbar, click  **Parameters** and choose **Add > Parameters**.
- 2 In the **Settings** window for **Parameters**, type Model Parameters in the **Label** text field.
- 3 Locate the **Parameters** section. Click  **Load from File**.
- 4 Browse to the model's Application Libraries folder and double-click the file `acoustics_pipe_system_parameters.txt`.
This group includes all the parameters that define the model like material properties, frequencies of interest, and the total time of the analysis.

DEFINITIONS

Rectangle 1 (rect1)

- 1 In the **Model Builder** window, expand the **Component 1 (comp1) > Definitions** node.
- 2 Right-click **Definitions** and choose **Functions > Rectangle**.
- 3 In the **Settings** window for **Rectangle**, locate the **Parameters** section.
- 4 In the **Lower limit** text field, type $0.5 \cdot T_0$.
- 5 In the **Upper limit** text field, type $3 \cdot T_0$.
- 6 Click to expand the **Smoothing** section. In the **Size of transition zone** text field, type T_0 .

Volume force

- 1 In the **Definitions** toolbar, click  **Analytic**.
- 2 In the **Settings** window for **Analytic**, type Volume force in the **Label** text field.
- 3 In the **Function name** text field, type volforc.
- 4 Locate the **Definition** section. In the **Expression** text field, type $\text{rect}(t[1/s]) * \sin(2 * \pi * f_0 * t)$.
- 5 In the **Arguments** text field, type t.
- 6 Locate the **Units** section. In the table, enter the following settings:

Argument	Unit
t	s

- 7 In the **Function** text field, type N/m^3 .
- 8 Locate the **Plot Parameters** section. In the table, enter the following settings:

Plot	Argument	Lower limit	Upper limit	Fixed value	Unit
$\sqrt{\quad}$	t	0	$3.5 * T_0$	0	s

- 9 Click  **Plot**.

The image should look like that in [Figure 4](#).

1D Pipes

- 1 In the **Definitions** toolbar, click  **Explicit**.
- 2 In the **Settings** window for **Explicit**, type 1D Pipes in the **Label** text field.
- 3 Locate the **Input Entities** section. From the **Geometric entity level** list, choose **Edge**.
- 4 Select Edges 1, 2, 20, 37, and 60 only.

Pipe Ends

- 1 In the **Definitions** toolbar, click  **Explicit**.
- 2 In the **Settings** window for **Explicit**, type Pipe Ends in the **Label** text field.
- 3 Locate the **Input Entities** section. From the **Geometric entity level** list, choose **Point**.
- 4 Select Points 1, 11, and 38 only.

ADD MATERIAL

- 1 In the **Materials** toolbar, click  **Add Material** to open the **Add Material** window.
- 2 Go to the **Add Material** window.
- 3 In the tree, select **Built-in > Water, liquid**.

- 4 Click the **Add to Component** button in the window toolbar three times.
- 5 In the **Materials** toolbar, click  **Add Material** to close the **Add Material** window.

MATERIALS



Water, liquid 1 (mat2)

- 1 In the **Settings** window for **Material**, locate the **Geometric Entity Selection** section.
- 2 From the **Geometric entity level** list, choose **Edge**.
- 3 From the **Selection** list, choose **ID Pipes**.

Water, liquid 2 (mat3)

- 1 In the **Model Builder** window, click **Water, liquid 2 (mat3)**.
- 2 In the **Settings** window for **Material**, locate the **Geometric Entity Selection** section.
- 3 From the **Geometric entity level** list, choose **Boundary**.
- 4 Select Boundary 1 only.

ADD PHYSICS

- 1 In the **Home** toolbar, click  **Add Physics** to open the **Add Physics** window.
- 2 Go to the **Add Physics** window.
- 3 In the tree, select **Acoustics** > **Pipe Acoustics** > **Pipe Acoustics, Transient (patd)**.
- 4 Click the **Add to Component I** button in the window toolbar.
- 5 In the tree, select **Acoustics** > **Pressure Acoustics** > **Pressure Acoustics, Transient (actd)**.
- 6 Click the **Add to Component I** button in the window toolbar.
- 7 In the tree, select **Acoustics** > **Pressure Acoustics** > **Pressure Acoustics, Boundary Mode (acbm)**.
- 8 Click the **Add to Component I** button in the window toolbar.
- 9 In the tree, select **Acoustics** > **Pipe Acoustics** > **Pipe Acoustics, Frequency Domain (pafd)**.
- 10 Click the **Add to Component I** button in the window toolbar.
- 11 In the tree, select **Acoustics** > **Pressure Acoustics** > **Pressure Acoustics, Frequency Domain (acpr)**.
- 12 Click the **Add to Component I** button in the window toolbar.
- 13 In the **Home** toolbar, click  **Add Physics** to close the **Add Physics** window.

PIPE ACOUSTICS, TRANSIENT (PATD)

- 1 In the **Settings** window for **Pipe Acoustics, Transient**, locate the **Edge Selection** section.

- 2 From the **Selection** list, choose **ID Pipes**.
- 3 Locate the **Transient Solver Settings** section. In the $f_{\max, sol}$ text field, type f_0 .

Pipe Properties 1

- 1 In the **Model Builder** window, under **Component 1 (comp1) > Pipe Acoustics, Transient (patd)** click **Pipe Properties 1**.
- 2 In the **Settings** window for **Pipe Properties**, locate the **Pipe Shape** section.
- 3 From the list, choose **Circular**.
- 4 In the d_i text field, type D_i .

Pipe Properties 2

- 1 In the **Physics** toolbar, click  **Edges** and choose **Pipe Properties**.
- 2 Select Edge 20 only.
- 3 In the **Settings** window for **Pipe Properties**, locate the **Pipe Shape** section.
- 4 From the list, choose **Circular**.
- 5 In the d_i text field, type $D_i * 2/3$.

End Impedance 1

- 1 In the **Physics** toolbar, click  **Points** and choose **End Impedance**.
- 2 In the **Settings** window for **End Impedance**, locate the **Point Selection** section.
- 3 From the **Selection** list, choose **Pipe Ends**.

Volume Force 1

- 1 In the **Physics** toolbar, click  **Edges** and choose **Volume Force**.
- 2 Select Edge 1 only.
- 3 In the **Settings** window for **Volume Force**, locate the **Volume Force** section.
- 4 Specify the \mathbf{F} vector as

$\text{volforc}(t)$	x
0	y
0	z

PRESSURE ACOUSTICS, TRANSIENT (ACTD)

- 1 In the **Model Builder** window, under **Component 1 (comp1)** click **Pressure Acoustics, Transient (actd)**.
- 2 In the **Settings** window for **Pressure Acoustics, Transient**, locate the **Transient Solver and Mesh Settings** section.

3 In the f_{\max} text field, type f_0 .

PRESSURE ACOUSTICS, BOUNDARY MODE (ACBM)

- 1 In the **Model Builder** window, under **Component 1 (comp1)** click **Pressure Acoustics, Boundary Mode (acbm)**.
- 2 In the **Settings** window for **Pressure Acoustics, Boundary Mode**, locate the **Boundary Selection** section.
- 3 Click  **Clear Selection**.
- 4 Select Boundary 1 only.

PIPE ACOUSTICS, FREQUENCY DOMAIN (PAFD)

- 1 In the **Model Builder** window, under **Component 1 (comp1)** click **Pipe Acoustics, Frequency Domain (pafd)**.
- 2 In the **Settings** window for **Pipe Acoustics, Frequency Domain**, locate the **Edge Selection** section.
- 3 From the **Selection** list, choose **ID Pipes**.

Pipe Properties 1

- 1 In the **Model Builder** window, under **Component 1 (comp1)** > **Pipe Acoustics, Frequency Domain (pafd)** click **Pipe Properties 1**.
- 2 In the **Settings** window for **Pipe Properties**, locate the **Pipe Shape** section.
- 3 From the list, choose **Circular**.
- 4 In the d_i text field, type D_i .

Pipe Properties 2

- 1 In the **Physics** toolbar, click  **Edges** and choose **Pipe Properties**.
- 2 Select Edge 20 only.
- 3 In the **Settings** window for **Pipe Properties**, locate the **Pipe Shape** section.
- 4 From the list, choose **Circular**.
- 5 In the d_i text field, type $D_i * 2/3$.

End Impedance 1

- 1 In the **Physics** toolbar, click  **Points** and choose **End Impedance**.
- 2 In the **Settings** window for **End Impedance**, locate the **Point Selection** section.
- 3 From the **Selection** list, choose **Pipe Ends**.

Volume Force 1

- 1 In the **Physics** toolbar, click  **Edges** and choose **Volume Force**.
- 2 Select Edge 1 only.
- 3 In the **Settings** window for **Volume Force**, locate the **Volume Force** section.
- 4 Specify the **F** vector as

1	x
0	y
0	z

MULTIPHYSICS

Acoustic–Pipe Acoustic Connection 1 (apc1)

In the **Physics** toolbar, click  **Multiphysics Couplings** and choose **Global > Acoustic–Pipe Acoustic Connection**.

Acoustic–Pipe Acoustic Connection 2 (apc2)

- 1 In the **Physics** toolbar, click  **Multiphysics Couplings** and choose **Global > Acoustic–Pipe Acoustic Connection**.
- 2 In the **Settings** window for **Acoustic–Pipe Acoustic Connection**, locate the **Coupled Interfaces** section.
- 3 From the **Acoustics** list, choose **Pressure Acoustics, Frequency Domain (acpr)**.
- 4 From the **Pipe acoustics** list, choose **Pipe Acoustics, Frequency Domain (pafd)**.

MESH 1

In this model, the mesh is set up manually. Proceed by directly adding the desired mesh component.

Free Tetrahedral 1

In the **Mesh** toolbar, click  **Free Tetrahedral**.

Size

- 1 In the **Model Builder** window, click **Size**.
- 2 In the **Settings** window for **Size**, locate the **Element Size** section.
- 3 Click the **Custom** button.
- 4 Locate the **Element Size Parameters** section. In the **Maximum element size** text field, type $\min(1\text{am}0/12, D_i/2)$.
- 5 In the **Minimum element size** text field, type $\min(1\text{am}0/24, D_i/6)$.

6 Click  **Build Selected**.

Edge 1

- 1 In the **Mesh** toolbar, click  **More Generators** and choose **Edge**.
- 2 In the **Settings** window for **Edge**, locate the **Edge Selection** section.
- 3 From the **Selection** list, choose **ID Pipes**.



Free Triangular 1

- 1 In the **Mesh** toolbar, click  **More Generators** and choose **Free Triangular**.
- 2 Select Boundary 1 only.

Size 1

- 1 Right-click **Free Triangular 1** and choose **Size**.
- 2 In the **Settings** window for **Size**, locate the **Element Size** section.
- 3 Click the **Custom** button.
- 4 Locate the **Element Size Parameters** section.
- 5 Select the **Maximum element size** checkbox. In the associated text field, type $D_i/12$.
- 6 Select the **Minimum element size** checkbox. In the associated text field, type $D_i/12$.
- 7 Click  **Build All**.

ADD STUDY

- 1 In the **Home** toolbar, click  **Add Study** to open the **Add Study** window.
- 2 Go to the **Add Study** window.
- 3 Find the **Physics interfaces in study** subsection. In the table, clear the **Solve** checkboxes for **Pressure Acoustics**, **Boundary Mode (acbm)**, **Pipe Acoustics**, **Frequency Domain (pafd)**, and **Pressure Acoustics, Frequency Domain (acpr)**.
- 4 Find the **Studies** subsection. In the **Select Study** tree, select **General Studies > Time Dependent**.
- 5 Find the **Multiphysics couplings in study** subsection. In the table, clear the **Solve** checkbox for **Acoustic–Pipe Acoustic Connection 2 (apc2)**.
- 6 Click the **Add Study** button in the window toolbar.
- 7 In the **Home** toolbar, click  **Add Study** to close the **Add Study** window.

STUDY 1

Step 1: Time Dependent

- 1 In the **Settings** window for **Time Dependent**, locate the **Study Settings** section.

- 2 In the **Output times** text field, type range (0, T0/24, Tend).
- 3 In the **Model Builder** window, click **Study 1**.
- 4 In the **Settings** window for **Study**, locate the **Study Settings** section.
- 5 Clear the **Generate default plots** checkbox.
- 6 In the **Label** text field, type Study 1 - Pipe System Transient.
- 7 In the **Study** toolbar, click  **Compute**.

ADD STUDY

- 1 In the **Study** toolbar, click  **Add Study** to open the **Add Study** window.
- 2 Go to the **Add Study** window.
- 3 Find the **Physics interfaces in study** subsection. In the table, clear the **Solve** checkboxes for **Pipe Acoustics, Transient (patd)**, **Pressure Acoustics, Transient (actd)**, **Pipe Acoustics, Frequency Domain (pafd)**, and **Pressure Acoustics, Frequency Domain (acpr)**.
- 4 Find the **Multiphysics couplings in study** subsection. In the table, clear the **Solve** checkboxes for **Acoustic–Pipe Acoustic Connection 1 (apc1)** and **Acoustic–Pipe Acoustic Connection 2 (apc2)**.
- 5 Find the **Studies** subsection. In the **Select Study** tree, select **Preset Studies for Selected Physics Interfaces > Mode Analysis**.
- 6 Click the **Add Study** button in the window toolbar.

STUDY 2 - MODE ANALYSIS CUT ON/OFF

- 1 In the **Settings** window for **Study**, type Study 2 - Mode Analysis Cut on/off in the **Label** text field.
- 2 Locate the **Study Settings** section. Clear the **Generate default plots** checkbox.

Step 1: Mode Analysis

- 1 In the **Model Builder** window, under **Study 2 - Mode Analysis Cut on/off** click **Step 1: Mode Analysis**.
- 2 In the **Settings** window for **Mode Analysis**, locate the **Study Settings** section.
- 3 In the **Mode analysis frequency** text field, type f_0 .
- 4 Select the **Desired number of modes** checkbox. In the associated text field, type 10.
- 5 Select the **Search for modes around shift** checkbox.
- 6 In the **Study** toolbar, click  **Compute**.

ADD STUDY

- 1 Go to the **Add Study** window.
- 2 Find the **Physics interfaces in study** subsection. In the table, clear the **Solve** checkboxes for **Pipe Acoustics, Transient (patd)**, **Pressure Acoustics, Transient (actd)**, and **Pressure Acoustics, Boundary Mode (acbm)**.
- 3 Find the **Multiphysics couplings in study** subsection. In the table, clear the **Solve** checkbox for **Acoustic–Pipe Acoustic Connection 1 (apcl)**.
- 4 Find the **Studies** subsection. In the **Select Study** tree, select **General Studies > Frequency Domain**.
- 5 Click the **Add Study** button in the window toolbar.
- 6 In the **Study** toolbar, click  **Add Study** to close the **Add Study** window.

STUDY 3 - PIPE SYSTEM FREQUENCY DOMAIN

- 1 In the **Settings** window for **Study**, type Study 3 - Pipe System Frequency Domain in the **Label** text field.
- 2 Locate the **Study Settings** section. Clear the **Generate default plots** checkbox.

Step 1: Frequency Domain

- 1 In the **Model Builder** window, under **Study 3 - Pipe System Frequency Domain** click **Step 1: Frequency Domain**.
- 2 In the **Settings** window for **Frequency Domain**, locate the **Study Settings** section.
- 3 In the **Frequencies** text field, type f_0 .
- 4 In the **Study** toolbar, click  **Compute**.

RESULTS

Surface 1

- 1 In the **Model Builder** window, expand the **Results** node.
- 2 Right-click **Results > Datasets** and choose **Surface**.
- 3 In the **Settings** window for **Surface**, locate the **Data** section.
- 4 From the **Dataset** list, choose **Study 2 - Mode Analysis Cut on/off/Solution 2 (sol2)**.
- 5 Locate the **Selection** section. Click  **Paste Selection**.
- 6 In the **Paste Selection** dialog, type 1 in the **Selection** text field.
- 7 Click **OK**.

Acoustic Pressure (patd)

- 1 In the **Results** toolbar, click  **3D Plot Group**.
- 2 In the **Settings** window for **3D Plot Group**, type Acoustic Pressure (patd) in the **Label** text field.
- 3 Locate the **Data** section. From the **Time (s)** list, choose **0.025**.
- 4 Click to expand the **Title** section. From the **Title type** list, choose **Manual**.
- 5 In the **Title** text area, type Pressure (Pa).
- 6 In the **Parameter indicator** text field, type $\text{Time} = \text{eval}(t, s) \text{ s}$.
- 7 Locate the **Color Legend** section. Select the **Show maximum and minimum values** checkbox.

Line 1

- 1 Right-click **Acoustic Pressure (patd)** and choose **Line**.
- 2 In the **Settings** window for **Line**, click to expand the **Range** section.
- 3 Select the **Manual color range** checkbox.
- 4 In the **Minimum** text field, type -0.005.
- 5 In the **Maximum** text field, type 0.005.
- 6 Locate the **Coloring and Style** section. From the **Line type** list, choose **Tube**.
- 7 In the **Tube radius expression** text field, type $0.5 \cdot \text{patd} \cdot \text{dh}$.
- 8 Select the **Radius scale factor** checkbox.
- 9 From the **Color table** list, choose **Wave**.
- 10 From the **Scale** list, choose **Linear symmetric**.

Deformation 1

- 1 Right-click **Line 1** and choose **Deformation**.
- 2 In the **Settings** window for **Deformation**, locate the **Expression** section.
- 3 In the **X-component** text field, type 0.
- 4 In the **Y-component** text field, type 0.
- 5 In the **Z-component** text field, type p.
- 6 Select the **Description** checkbox. In the associated text field, type 20.

Surface 1

- 1 In the **Model Builder** window, right-click **Acoustic Pressure (patd)** and choose **Surface**.
- 2 In the **Settings** window for **Surface**, locate the **Expression** section.
- 3 In the **Expression** text field, type $p2$.

- 4 Click to expand the **Inherit Style** section. From the **Plot** list, choose **Line 1**.

Deformation 1

- 1 Right-click **Surface 1** and choose **Deformation**.
- 2 In the **Settings** window for **Deformation**, locate the **Expression** section.
- 3 In the **X-component** text field, type 0.
- 4 In the **Y-component** text field, type 0.
- 5 In the **Z-component** text field, type p2.

Table Annotation 1

- 1 In the **Model Builder** window, right-click **Acoustic Pressure (patd)** and choose **Table Annotation**.
- 2 In the **Settings** window for **Table Annotation**, locate the **Data** section.
- 3 From the **Source** list, choose **Local table**.
- 4 In the table, enter the following settings:

x-coordinate	y-coordinate	z-coordinate	Annotation
$-L1+Lj/2$	0	0	Point A
$-Lj/2$	-L2	0	Point B
L3	-L4	0	Point C

- 5 In the **Acoustic Pressure (patd)** toolbar, click  **Plot**.

The image should look like that in [Figure 5](#). The image can be animated to show the propagation of the pressure and its subsequent reflections.

Acoustic Pressure in Points

- 1 In the **Results** toolbar, click  **ID Plot Group**.
- 2 In the **Settings** window for **ID Plot Group**, type Acoustic Pressure in Points in the **Label** text field.
- 3 Click to expand the **Title** section. From the **Title type** list, choose **Manual**.
- 4 In the **Title** text area, type Pressure at various points (Pa).
- 5 Locate the **Plot Settings** section.
- 6 Select the **x-axis label** checkbox. In the associated text field, type Time (s).
- 7 Select the **y-axis label** checkbox. In the associated text field, type Pressure (Pa).
- 8 Locate the **Legend** section. From the **Position** list, choose **Upper left**.

Point A

- 1 Right-click **Acoustic Pressure in Points** and choose **Point Graph**.
- 2 In the **Settings** window for **Point Graph**, type Point A in the **Label** text field.
- 3 Select Point 2 only.
- 4 Click to expand the **Legends** section. Select the **Show legends** checkbox.
- 5 Find the **Include** subsection. Select the **Label** checkbox.
- 6 Clear the **Point** checkbox.
- 7 Clear the **Solution** checkbox.

Point B

- 1 In the **Model Builder** window, right-click **Acoustic Pressure in Points** and choose **Point Graph**.
- 2 In the **Settings** window for **Point Graph**, type Point B in the **Label** text field.
- 3 Select Point 11 only.
- 4 Locate the **y-Axis Data** section. In the **Expression** text field, type $p+1[\text{Pa}]$.
- 5 Locate the **Legends** section. Select the **Show legends** checkbox.
- 6 Find the **Include** subsection. Select the **Label** checkbox.
- 7 Clear the **Point** checkbox.
- 8 Clear the **Solution** checkbox.
- 9 Find the **Prefix and suffix** subsection. In the **Suffix** text field, type (offset by 1 Pa).

Point C

- 1 Right-click **Acoustic Pressure in Points** and choose **Point Graph**.
- 2 In the **Settings** window for **Point Graph**, type Point C in the **Label** text field.
- 3 Select Point 38 only.
- 4 Locate the **y-Axis Data** section. In the **Expression** text field, type $p+2[\text{Pa}]$.
- 5 Locate the **Legends** section. Select the **Show legends** checkbox.
- 6 Find the **Include** subsection. Select the **Label** checkbox.
- 7 Clear the **Point** checkbox.
- 8 Clear the **Solution** checkbox.
- 9 Find the **Prefix and suffix** subsection. In the **Suffix** text field, type (offset by 2 Pa).
- 10 In the **Acoustic Pressure in Points** toolbar, click  **Plot**.

The image should look like that in [Figure 6](#).

Mode Analysis Pressure (acbm)

- 1 In the **Results** toolbar, click  **2D Plot Group**.
- 2 In the **Settings** window for **2D Plot Group**, type Mode Analysis Pressure (acbm) in the **Label** text field.

Surface 1

- 1 Right-click **Mode Analysis Pressure (acbm)** and choose **Surface**.
- 2 In the **Settings** window for **Surface**, locate the **Expression** section.
- 3 In the **Expression** text field, type p3.
- 4 Locate the **Coloring and Style** section. From the **Color table** list, choose **Wave**.
- 5 From the **Scale** list, choose **Linear symmetric**.
- 6 In the **Mode Analysis Pressure (acbm)** toolbar, click  **Plot**.

Acoustic Pressure (pafd)

- 1 In the **Results** toolbar, click  **3D Plot Group**.
- 2 In the **Settings** window for **3D Plot Group**, type Acoustic Pressure (pafd) in the **Label** text field.
- 3 Locate the **Data** section. From the **Dataset** list, choose **Study 3 - Pipe System Frequency Domain/Solution 3 (sol3)**.
- 4 Locate the **Title** section. From the **Title type** list, choose **Manual**.
- 5 In the **Title** text area, type Pressure (Pa).
- 6 In the **Parameter indicator** text field, type $\text{freq} = \text{eval}(\text{freq}, \text{Hz})$ Hz.

Line 1

- 1 Right-click **Acoustic Pressure (pafd)** and choose **Line**.
- 2 In the **Settings** window for **Line**, locate the **Expression** section.
- 3 In the **Expression** text field, type p4.
- 4 Locate the **Coloring and Style** section. From the **Line type** list, choose **Tube**.
- 5 In the **Tube radius expression** text field, type $0.5 * \text{pafd.dh}$.
- 6 Select the **Radius scale factor** checkbox.
- 7 From the **Color table** list, choose **Wave**.
- 8 From the **Scale** list, choose **Linear symmetric**.

Deformation 1

- 1 Right-click **Line 1** and choose **Deformation**.
- 2 In the **Settings** window for **Deformation**, locate the **Expression** section.

- 3 In the **X-component** text field, type 0.
- 4 In the **Y-component** text field, type 0.
- 5 In the **Z-component** text field, type p4.
- 6 Locate the **Scale** section.
- 7 Select the **Scale factor** checkbox. In the associated text field, type 2.

Surface 1

- 1 In the **Model Builder** window, right-click **Acoustic Pressure (pafd)** and choose **Surface**.
- 2 In the **Settings** window for **Surface**, locate the **Expression** section.
- 3 In the **Expression** text field, type p5.
- 4 Locate the **Inherit Style** section. From the **Plot** list, choose **Line 1**.

Deformation 1

- 1 Right-click **Surface 1** and choose **Deformation**.
- 2 In the **Settings** window for **Deformation**, locate the **Expression** section.
- 3 In the **X-component** text field, type 0.
- 4 In the **Y-component** text field, type 0.
- 5 In the **Z-component** text field, type p5.
- 6 In the **Acoustic Pressure (pafd)** toolbar, click  **Plot**.

The image should look like that in [Figure 7](#).



Appendix — Geometry Modeling Instructions

From the **File** menu, choose **New**.

NEW

In the **New** window, click  **Model Wizard**.

MODEL WIZARD

- 1 In the **Model Wizard** window, click  **3D**.
- 2 Click  **Done**.

GLOBAL DEFINITIONS

Parameters geom sequence

- 1 In the **Model Builder** window, under **Global Definitions** click **Parameters 1**.
- 2 In the **Settings** window for **Parameters**, locate the **Parameters** section.



- 3 Click  **Load from File**.
- 4 Browse to the model's Application Libraries folder and double-click the file `acoustics_pipe_system_geom_sequence_parameters.txt`.
- 5 In the **Label** text field, type `Parameters geom sequence`.

GEOMETRY I



Line Segment 1 (ls1)

- 1 In the **Model Builder** window, expand the **Component 1 (comp1) > Geometry 1** node.
- 2 Right-click **Geometry 1** and choose **More Primitives > Line Segment**.
- 3 In the **Settings** window for **Line Segment**, locate the **Starting Point** section.
- 4 From the **Specify** list, choose **Coordinates**.
- 5 In the **x** text field, type `-Lj`.
- 6 Locate the **Endpoint** section. From the **Specify** list, choose **Coordinates**.
- 7 In the **x** text field, type `-L1+Lj/2`.
- 8 Click  **Build Selected**.



Line Segment 2 (ls2)

- 1 In the **Geometry** toolbar, click  **More Primitives** and choose **Line Segment**.
- 2 In the **Settings** window for **Line Segment**, locate the **Starting Point** section.
- 3 From the **Specify** list, choose **Coordinates**.
- 4 In the **x** text field, type `-L1+Lj/2`.
- 5 Locate the **Endpoint** section. From the **Specify** list, choose **Coordinates**.
- 6 In the **x** text field, type `-L1`.
- 7 Click  **Build Selected**.



Cylinder 1 (cyl1)

- 1 In the **Geometry** toolbar, click  **Cylinder**.
- 2 In the **Settings** window for **Cylinder**, locate the **Size and Shape** section.
- 3 In the **Radius** text field, type `Di/2`.
- 4 In the **Height** text field, type `Lj`.
- 5 Locate the **Position** section. In the **x** text field, type `-Lj`.
- 6 Locate the **Axis** section. From the **Axis type** list, choose **x-axis**.
- 7 Click  **Build Selected**.



Cylinder 2 (cyl2)

- 1 In the **Geometry** toolbar, click  **Cylinder**.
- 2 In the **Settings** window for **Cylinder**, locate the **Size and Shape** section.
- 3 In the **Radius** text field, type $D_i/3$.
- 4 In the **Height** text field, type $L_j/2$.
- 5 Locate the **Position** section. In the **x** text field, type $-L_j/2$.
- 6 In the **y** text field, type $-L_j/2$.
- 7 Locate the **Axis** section. From the **Axis type** list, choose **y-axis**.
- 8 Click  **Build Selected**.



Union 1 (uni1)

- 1 In the **Geometry** toolbar, click  **Booleans and Partitions** and choose **Union**.
- 2 Select the objects **cyl1** and **cyl2** only.
- 3 In the **Settings** window for **Union**, click  **Build Selected**.



Line Segment 3 (ls3)

- 1 In the **Geometry** toolbar, click  **More Primitives** and choose **Line Segment**.
- 2 In the **Settings** window for **Line Segment**, locate the **Starting Point** section.
- 3 From the **Specify** list, choose **Coordinates**.
- 4 In the **x** text field, type $-L_j/2$.
- 5 In the **y** text field, type $-L_j/2$.
- 6 Locate the **Endpoint** section. From the **Specify** list, choose **Coordinates**.
- 7 In the **x** text field, type $-L_j/2$.
- 8 In the **y** text field, type $-L_2$.
- 9 Click  **Build Selected**.



Line Segment 4 (ls4)

- 1 In the **Geometry** toolbar, click  **More Primitives** and choose **Line Segment**.
- 2 In the **Settings** window for **Line Segment**, locate the **Starting Point** section.
- 3 From the **Specify** list, choose **Coordinates**.
- 4 Locate the **Endpoint** section. From the **Specify** list, choose **Coordinates**.
- 5 In the **x** text field, type $L_3-L_j/2$.
- 6 Click  **Build Selected**.



Cylinder 3 (cyl3)

- 1 In the **Geometry** toolbar, click  **Cylinder**.
- 2 In the **Settings** window for **Cylinder**, locate the **Size and Shape** section.
- 3 In the **Radius** text field, type $D_i/2$.
- 4 In the **Height** text field, type $L_j/2 - r_{bend} - D_i/2$.
- 5 Locate the **Position** section. In the **x** text field, type $L_3 - L_j/2$.
- 6 Locate the **Axis** section. From the **Axis type** list, choose **x-axis**.
- 7 Click  **Build Selected**.
- 8 Click the  **Zoom Extents** button in the **Graphics** toolbar.

Revolve 1 (rev1)



- 1 In the **Geometry** toolbar, click  **Revolve**.
- 2 On the object **cyl3**, select Boundary 4 only.
- 3 In the **Settings** window for **Revolve**, locate the **Revolution Angles** section.
- 4 Click the **Angles** button.
- 5 In the **End angle** text field, type 90.
- 6 Locate the **Revolution Axis** section. Find the **Point on the revolution axis** subsection. In the **yw** text field, type $-r_{bend} - D_i/2$.
- 7 Find the **Direction of revolution axis** subsection. In the **xw** text field, type 1.
- 8 In the **yw** text field, type 0.
- 9 Click  **Build Selected**.

Cylinder 4 (cyl4)

- 1 In the **Geometry** toolbar, click  **Cylinder**.
- 2 In the **Settings** window for **Cylinder**, locate the **Size and Shape** section.
- 3 In the **Radius** text field, type $D_i/2$.
- 4 In the **Height** text field, type $L_j/2 - r_{bend} - D_i/2$.
- 5 Locate the **Position** section. In the **x** text field, type L_3 .
- 6 In the **y** text field, type $-L_j/2$.
- 7 Locate the **Axis** section. From the **Axis type** list, choose **y-axis**.
- 8 Click  **Build Selected**.

Line Segment 5 (ls5)

- 1 In the **Geometry** toolbar, click  **More Primitives** and choose **Line Segment**.

- 2 In the **Settings** window for **Line Segment**, locate the **Starting Point** section.
- 3 From the **Specify** list, choose **Coordinates**.
- 4 In the **x** text field, type $L3$.
- 5 In the **y** text field, type $-Lj/2$.
- 6 Locate the **Endpoint** section. From the **Specify** list, choose **Coordinates**.
- 7 In the **x** text field, type $L3$.
- 8 In the **y** text field, type $-L4$.
- 9 Click  **Build Selected**.
- 10 In the **Geometry** toolbar, click  **Build All**.