



Model created in COMSOL Multiphysics 6.4

# Pipe Erosion due to Contaminant Particles

## *Introduction*

---

Pipelines used to transport fluids such as oil and gas often contain solid contaminant particles, such as sand, that are carried along with the moving fluid. These solid particles can impinge on the pipe walls, deforming or stripping away the surface material in a process known as erosion.

In addition to physical depletion of material from the pipe walls, erosion by solid particles may be detrimental to the condition of the pipelines in other, more indirect ways. For example, solid particles may damage corrosion-resistant layers inside the pipes or remove chemical inhibitors from the interior surfaces, exposing material in the pipe walls that may be more susceptible to corrosion. Such synergistic effects, often indicated by the term *erosion-corrosion*, can be extremely costly as they may cause oil and gas pipelines to degrade at an accelerated rate.

Simulation of pipeline erosion can be a powerful and cost-effective tool for design, optimization, and diagnostics. In this example, the rate of erosive wear in a 90° pipe elbow is computed and compared for three different erosion models.

## *Model Definition*

---

The model geometry consists of two straight cylindrical pipe sections, each 50 cm in length and 20 cm in diameter. The straight sections are connected by a 90° pipe bend with a 50 cm radius of curvature. The pipe is used to transport water at room temperature with a maximum inlet velocity of 20 m/s. Only half the pipe is modeled because the  $xy$ -plane is a symmetry plane. The water is treated as an incompressible fluid.

The pipe also transports solid particles at a rate of 0.6 kg/h. Although such particles would typically be assigned a size distribution, in this tutorial all particles have equal diameters of 0.17 mm.

## *Modeling Considerations*

---

The high Reynolds number,  $Re_D = 3.96 \times 10^6$  based on the pipe diameter, calls for a turbulence model with wall functions. Here, the  $k-\omega$  turbulence model is selected over the  $k-\epsilon$  model because it is more accurate than the  $k-\epsilon$  model for flows involving strong streamline curvature (Ref. 2).

A structured mesh is used to reduce the computational cost of the model. The boundary layer mesh is used to ensure that the flow close to the pipe walls is adequately resolved.

## Results and Discussion

The resulting velocity distribution is shown in [Figure 1](#). There is a separation zone after the bend which is consistent with the results in [Ref. 1](#). The outlet pipe length was made longer than the inlet pipe length in order to resolve this region. [Figure 2](#) shows a contour plot of the corresponding pressure distribution. The wall resolution in viscous units is plotted in [Figure 3](#); the value is less than 100 everywhere, suggesting that the boundary mesh on the walls is adequately refined.

The particle trajectories are shown in [Figure 4](#). The **Disappear** Wall condition has been used to hide particles that move through the pipe bend without touching the walls, so only the particles that have made contact with surfaces of the pipe bend are shown. The color expression is the acute angle of incidence in degrees, measured from the surface normal. It is clear that the particles only strike the surface at grazing angles.

Three different erosion models are used to compute the rate of erosive wear on the surface of the pipe elbow: **Finnie**, **DNV**, and **E/CRC**. These erosion models are built into the dedicated **Erosion** node, which can be added as a subnode to any **Wall** boundary condition. It is possible to solve for the rate of erosive wear using several different erosion models on the same set of boundaries. The erosion models are described in greater detail in the *Particle Tracing Module User's Guide*.

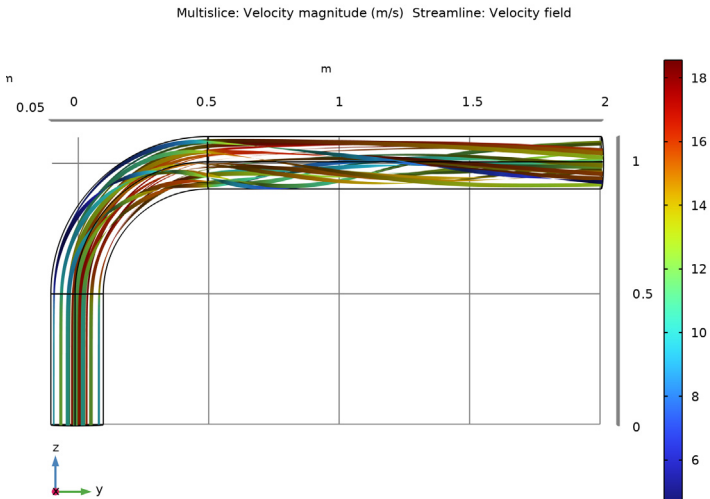

*Figure 1: Velocity streamlines in the pipe elbow.*

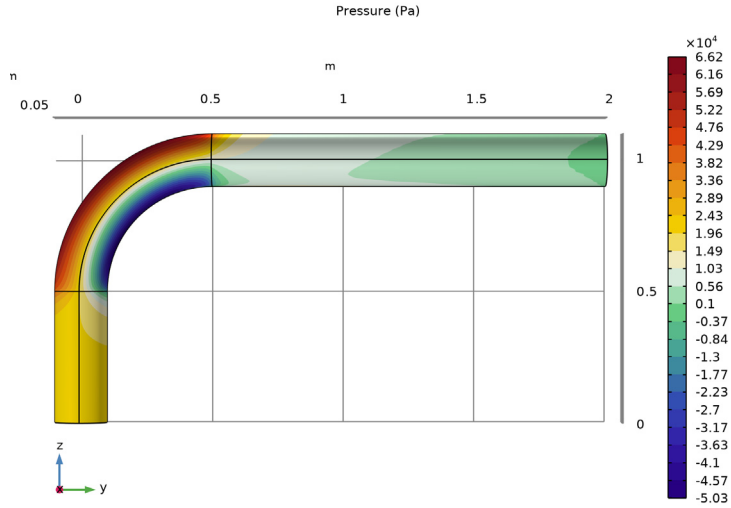

Figure 2: Contour plot of pressure in the pipe elbow.

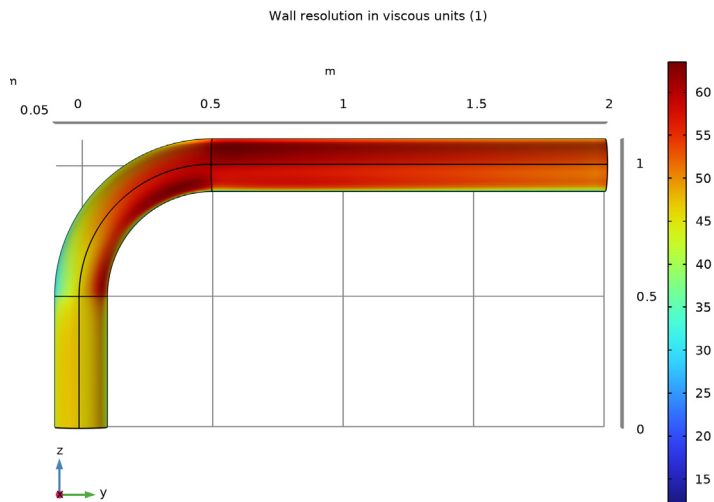

Figure 3: Wall resolution in viscous units. A value greater than several hundreds usually indicates that a mesh needs to be refined in the wall normal direction.

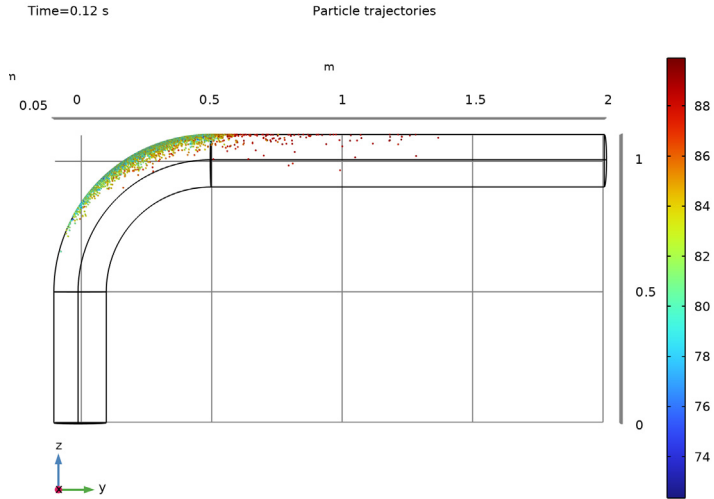

Figure 4: Particle trajectories. The color expression is the acute angle of incidence, measured from the surface normal.

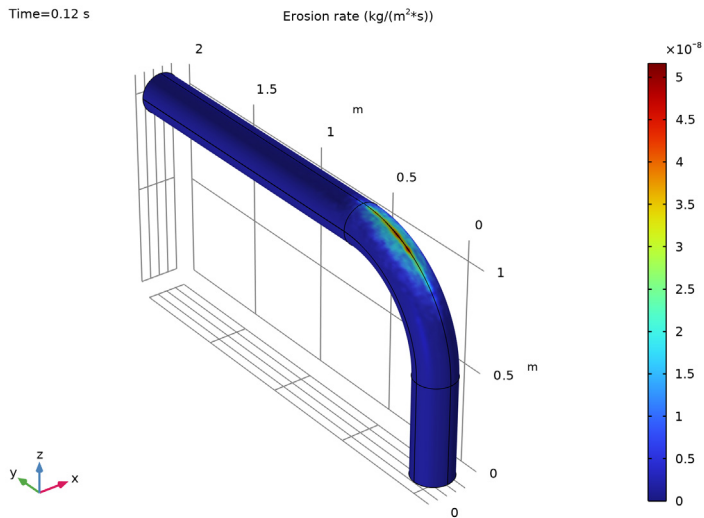

Figure 5: Rate of erosive wear on the pipe walls, computed using the Finnie model.

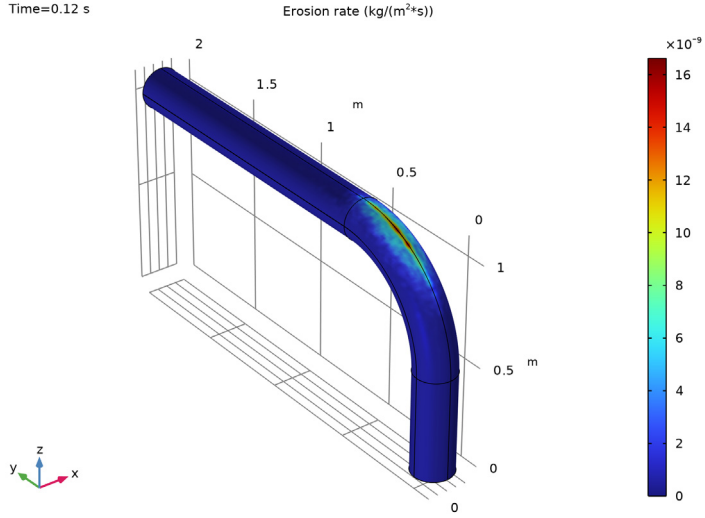

Figure 6: Rate of erosive wear on the pipe walls, computed using the DNV model.

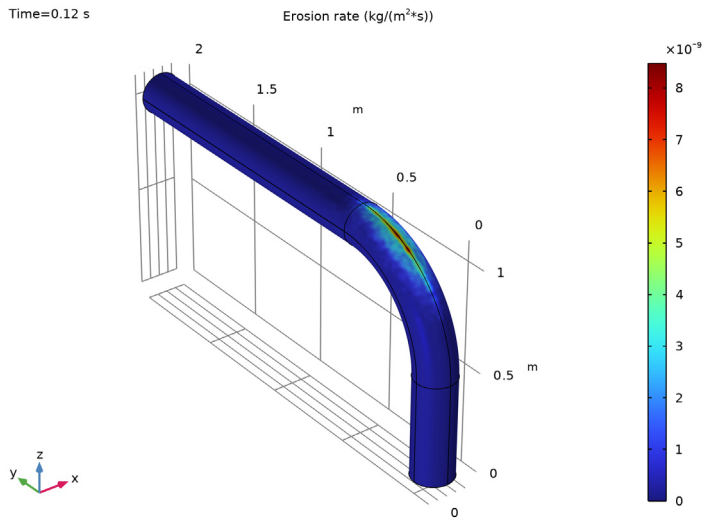

Figure 7: Rate of erosive wear on the pipe walls, computed using the E/CRC model.

## References

---

1. G.F. Homicz, “Computational Fluid Dynamic Simulations of Pipe Elbow Flow,” *SAND REPORT*, SAND2004-3467, Sandia National Laboratories, 2004.
  2. F. Menter, “Zonal Two Equation  $k$ - $\omega$  Turbulence Models for Aerodynamic Flows,” AIAA Paper #93-2906, *24th Fluid Dynamics Conference*, July 1993.
- 

**Application Library path:** Particle\_Tracing\_Module/Fluid\_Flow/  
pipe\_elbow\_erosion

---

## Modeling Instructions



---

From the **File** menu, choose **New**.

### NEW

In the **New** window, click  **Model Wizard**.

### MODEL WIZARD

- 1 In the **Model Wizard** window, click  **3D**.
- 2 In the **Select Physics** tree, select **Fluid Flow** > **Single-Phase Flow** > **Turbulent Flow** > **Turbulent Flow, k- $\omega$  (spf)**.
- 3 Click **Add**.
- 4 Click  **Study**.
- 5 In the **Select Study** tree, select **General Studies** > **Stationary**.
- 6 Click  **Done**.

### GLOBAL DEFINITIONS

#### Parameters 1

Load the model's parameters from a text file.

- 1 In the **Model Builder** window, under **Global Definitions** click **Parameters 1**.
- 2 In the **Settings** window for **Parameters**, locate the **Parameters** section.
- 3 Click  **Load from File**.
- 4 Browse to the model's Application Libraries folder and double-click the file `pipe_elbow_erosion_parameters.txt`.

## GEOMETRY 1

The geometry consists of two straight cylindrical pipe sections connected by a 90 degree pipe elbow.

### *Cylinder 1 (cyl1)*

- 1 In the **Geometry** toolbar, click  **Cylinder**.
- 2 In the **Settings** window for **Cylinder**, locate the **Size and Shape** section.
- 3 In the **Radius** text field, type r1.
- 4 In the **Height** text field, type L1.

### *Torus 1 (tor1)*

- 1 In the **Geometry** toolbar, click  **Torus**.
- 2 In the **Settings** window for **Torus**, locate the **Size and Shape** section.
- 3 In the **Major radius** text field, type R3.
- 4 In the **Minor radius** text field, type r3.
- 5 In the **Revolution angle** text field, type 90.
- 6 Locate the **Position** section. In the **y** text field, type R3.
- 7 In the **z** text field, type L1.
- 8 Locate the **Axis** section. From the **Axis type** list, choose **x-axis**.
- 9 Locate the **Rotation Angle** section. In the **Rotation** text field, type 180.

### *Cylinder 2 (cyl2)*

- 1 In the **Geometry** toolbar, click  **Cylinder**.
- 2 In the **Settings** window for **Cylinder**, locate the **Size and Shape** section.
- 3 In the **Radius** text field, type r2.
- 4 In the **Height** text field, type L2.
- 5 Locate the **Position** section. In the **y** text field, type R3.
- 6 In the **z** text field, type L1+R3.
- 7 Locate the **Axis** section. From the **Axis type** list, choose **y-axis**.

Use a work plane to create a separate boundary where particles will be released at the pipe inlet.

### *Work Plane 1 (wp1)*

- 1 In the **Geometry** toolbar, click  **Work Plane**.
- 2 In the **Settings** window for **Work Plane**, locate the **Plane Definition** section.

3 From the **Plane type** list, choose **Face parallel**.

4 On the object **cyII**, select Boundary 3 only.

It might be easier to select the correct boundary by using the **Selection List** window. To open this window, in the **Home** toolbar click **Windows** and choose **Selection List**. (If you are running the cross-platform desktop, you find **Windows** in the main menu.)

5 Click  **Go to Plane Geometry**.

*Work Plane 1 (wp1) > Plane Geometry*

1 In the **Settings** window for **Plane Geometry**, locate the **Visualization** section.

2 Select the **View work plane geometry in 3D** checkbox.

*Work Plane 1 (wp1) > Circle 1 (c1)*

1 In the **Work Plane** toolbar, click  **Circle**.

2 In the **Settings** window for **Circle**, locate the **Size and Shape** section.

3 In the **Radius** text field, type 0.05.

*Union 1 (uni1)*

1 In the **Model Builder** window, right-click **Geometry 1** and choose **Booleans and Partitions > Union**.

2 Click in the **Graphics** window and then press Ctrl+A to select all objects.

To save time and memory, exploit symmetry by only modeling the fluid flow and particle motion in half of the geometry.

*Work Plane 2 (wp2)*

1 In the **Geometry** toolbar, click  **Work Plane**.

2 In the **Settings** window for **Work Plane**, locate the **Plane Definition** section.

3 From the **Plane** list, choose **yz-plane**.

*Partition Objects 1 (par1)*

1 In the **Geometry** toolbar, click  **Booleans and Partitions** and choose **Partition Objects**.

2 Select the object **uni1** only.



3 In the **Settings** window for **Partition Objects**, locate the **Partition Objects** section.

4 From the **Partition with** list, choose **Work plane**.

*Delete Entities 1 (del1)*

1 Right-click **Geometry 1** and choose **Delete Entities**.

2 In the **Settings** window for **Delete Entities**, locate the **Entities or Objects to Delete** section.

- 3 From the **Geometric entity level** list, choose **Domain**.
- 4 On the object **par1**, select Domains 1–3 only.
- 5 Click  **Build All Objects**.
- 6 Click the  **Zoom Extents** button in the **Graphics** toolbar.

## TURBULENT FLOW, $k-\omega$ (SPF)

### *Inlet 1*

- 1 In the **Physics** toolbar, click  **Boundaries** and choose **Inlet**.
- 2 Select Boundaries 3 and 7 only.
- 3 In the **Settings** window for **Inlet**, locate the **Boundary Condition** section.
- 4 From the list, choose **Fully developed flow**.
- 5 Locate the **Fully Developed Flow** section. In the  $U_{av}$  text field, type  $V_i$ .
- 6 In the **Model Builder** window, click **Turbulent Flow,  $k-\omega$  (spf)**.
- 7 In the **Settings** window for **Turbulent Flow,  $k-\omega$** , locate the **Turbulence** section.
- 8 From the **Wall treatment** list, choose **Wall functions**.



### *Outlet 1*

- 1 In the **Physics** toolbar, click  **Boundaries** and choose **Outlet**.
- 2 Select Boundary 14 only.

### *Symmetry 1*

- 1 In the **Physics** toolbar, click  **Boundaries** and choose **Symmetry**.
- 2 Select Boundaries 1, 4, and 10 only.

## ADD MATERIAL

- 1 In the **Materials** toolbar, click  **Add Material** to open the **Add Material** window.
- 2 Go to the **Add Material** window.
- 3 In the tree, select **Built-in > Water, liquid**.
- 4 Click the **Add to Component** button in the window toolbar.
- 5 In the **Materials** toolbar, click  **Add Material** to close the **Add Material** window.

## MESH 1

### *Boundary Layers 1*

In the **Mesh** toolbar, click  **Boundary Layers**.

### *Boundary Layer Properties*

- 1 In the **Settings** window for **Boundary Layer Properties**, locate the **Layers** section.
- 2 In the **Number of layers** text field, type 5.
- 3 In the **Stretching factor** text field, type 2.2.
- 4 In the **Thickness adjustment factor** text field, type 0.4.

### *Size*

- 1 In the **Model Builder** window, under **Component 1 (comp1) > Mesh 1** click **Size**.
- 2 In the **Settings** window for **Size**, locate the **Element Size** section.
- 3 From the **Calibrate for** list, choose **Fluid dynamics**.
- 4 From the **Predefined** list, choose **Extra fine**.
- 5 Click to expand the **Element Size Parameters** section. In the **Maximum element size** text field, type  $r3/10$ .

### *Boundary Layers 1*

- 1 In the **Model Builder** window, click **Boundary Layers 1**.
- 2 In the **Settings** window for **Boundary Layers**, locate the **Geometric Entity Selection** section.
- 3 From the **Geometric entity level** list, choose **Boundary**.
- 4 Select Boundaries 3 and 7 only.
- 5 Click to expand the **Transition** section. Clear the **Smooth transition to interior mesh** checkbox.

### *Boundary Layer Properties*

- 1 In the **Model Builder** window, click **Boundary Layer Properties**.
- 2 Select Edges 3 and 12 only.

### *Swept 1*

In the **Mesh** toolbar, click  **Swept**.



### *Distribution 1*

- 1 Right-click **Swept 1** and choose **Distribution**.
- 2 In the **Settings** window for **Distribution**, locate the **Domain Selection** section.
- 3 Click  **Clear Selection**.
- 4 Select Domain 1 only.
- 5 Locate the **Distribution** section. In the **Number of elements** text field, type 40.

### *Distribution 2*

- 1 In the **Model Builder** window, right-click **Swept 1** and choose **Distribution**.
- 2 In the **Settings** window for **Distribution**, locate the **Domain Selection** section.
- 3 Click  **Clear Selection**.
- 4 Select Domain 2 only.
- 5 Locate the **Distribution** section. In the **Number of elements** text field, type 80.

### *Distribution 3*

- 1 Right-click **Swept 1** and choose **Distribution**.
- 2 In the **Settings** window for **Distribution**, locate the **Domain Selection** section.
- 3 Click  **Clear Selection**.
- 4 Select Domain 3 only.
- 5 Locate the **Distribution** section. From the **Distribution type** list, choose **Predefined**.
- 6 In the **Number of elements** text field, type 70.
- 7 In the **Element ratio** text field, type 5.
- 8 From the **Growth rate** list, choose **Exponential**.
- 9 Click  **Build All**.

### **STUDY 1**

In the **Study** toolbar, click  **Compute**.

### **RESULTS**



#### *Multislice 1*

- 1 In the **Model Builder** window, expand the **Velocity (spf)** node, then click **Multislice 1**.
- 2 In the **Settings** window for **Multislice**, locate the **Multiplane Data** section.
- 3 Find the **x-planes** subsection. In the **Planes** text field, type 0.
- 4 Find the **z-planes** subsection. In the **Planes** text field, type 0.

#### *Streamline 1*

- 1 In the **Model Builder** window, right-click **Velocity (spf)** and choose **Streamline**.
- 2 In the **Settings** window for **Streamline**, locate the **Coloring and Style** section.
- 3 Find the **Line style** subsection. From the **Type** list, choose **Ribbon**.
- 4 Select Boundaries 3 and 7 only.

### *Color Expression I*

- 1 In the **Velocity (spf)** toolbar, click  **Color Expression**.
- 2 In the **Settings** window for **Color Expression**, locate the **Coloring and Style** section.
- 3 Clear the **Color legend** checkbox.
- 4 In the **Velocity (spf)** toolbar, click  **Plot**.
- 5 Click the  **Go to YZ View** button in the **Graphics** toolbar.  
Compare the resulting plot to [Figure 1](#).



### *Pressure (spf)*

- 1 In the **Model Builder** window, under **Results** click **Pressure (spf)**.
- 2 In the **Pressure (spf)** toolbar, click  **Plot**.  
Compare the resulting plot to [Figure 2](#).

### *Wall Resolution (spf)*

- 1 In the **Model Builder** window, click **Wall Resolution (spf)**.
- 2 In the **Wall Resolution (spf)** toolbar, click  **Plot**.  
The **Wall Resolution** plot is used to verify that the mesh resolution in the model is adequate. Compare the resulting plot to [Figure 3](#).

## **ADD PHYSICS**

- 1 In the **Home** toolbar, click  **Add Physics** to open the **Add Physics** window.
- 2 Go to the **Add Physics** window.
- 3 In the tree, select **Fluid Flow** > **Particle Tracing** > **Particle Tracing for Fluid Flow (fpt)**.
- 4 Find the **Physics interfaces in study** subsection. Clear the checkbox next to **Study 1**.
- 5 Click the **Add to Component 1** button in the window toolbar.
- 6 In the **Home** toolbar, click  **Add Physics** to close the **Add Physics** window.

## **PARTICLE TRACING FOR FLUID FLOW (FPT)**

When **Specify mass flow rate** is selected from the **Particle release specification** list, each model particle is assumed to represent a number of real particles per unit time. Thus it is possible to compute the rate of erosive wear by contaminant particles in a stationary flow field.

- 1 In the **Settings** window for **Particle Tracing for Fluid Flow**, locate the **Particle Release and Propagation** section.
- 2 From the **Particle release specification** list, choose **Specify mass flow rate**.

### *Inlet 1*

- 1 In the **Physics** toolbar, click  **Boundaries** and choose **Inlet**.
- 2 In the **Mass flow rate** text field, type 0.6[kg/h].
- 3 In the **Settings** window for **Inlet**, locate the **Initial Position** section.
- 4 From the **Initial position** list, choose **Density**.
- 5 In the  $N$  text field, type 5000.
- 6 In the  $\rho$  text field, type `spf.U`.
- 7 Locate the **Initial Velocity** section. From the **u** list, choose **Velocity field (spf)**.
- 8 Select Boundary 7 only.

### *Particle Properties 1*

- 1 In the **Model Builder** window, click **Particle Properties 1**.
- 2 In the **Settings** window for **Particle Properties**, locate the **Particle Properties** section.
- 3 From the  $\rho_p$  list, choose **User defined**. In the associated text field, type `sigma`.
- 4 In the  $d_p$  text field, type `1.7E-4[m]`.

Compute the rate of erosive wear at the pipe elbow using three different erosion models.

### *Wall 1*

In the **Model Builder** window, click **Wall 1**.

### *Erosion 1*

- 1 In the **Physics** toolbar, click  **Attributes** and choose **Erosion**.
- 2 In the **Settings** window for **Erosion**, locate the **Erosion Model** section.
- 3 In the  $c_i$  text field, type `f.c`.
- 4 In the  $K$  text field, type `kappa`.
- 5 In the  $H_V$  text field, type `Hs`.
- 6 In the  $\rho$  text field, type `rho`.

### *Wall 1*

In the **Model Builder** window, click **Wall 1**.

### *Erosion 2*

- 1 In the **Physics** toolbar, click  **Attributes** and choose **Erosion**.
- 2 In the **Settings** window for **Erosion**, locate the **Erosion Model** section.
- 3 From the **Erosion model** list, choose **DNV**.

### Wall 1

In the **Model Builder** window, click **Wall 1**.

### Erosion 3

- 1 In the **Physics** toolbar, click  **Attributes** and choose **Erosion**.
- 2 In the **Settings** window for **Erosion**, locate the **Erosion Model** section.
- 3 From the **Erosion model** list, choose **E/CRC**.

### Drag Force 1

- 1 In the **Physics** toolbar, click  **Domains** and choose **Drag Force**.
- 2 In the **Settings** window for **Drag Force**, locate the **Domain Selection** section.
- 3 From the **Selection** list, choose **All domains**.
- 4 Locate the **Drag Force** section. From the **u** list, choose **Velocity field (spf)**.  
Select an option from the **Turbulent dispersion model** list to apply a random perturbation term to the fluid velocity when computing the drag force.
- 5 Locate the **Turbulent Dispersion** section. From the **Turbulent dispersion model** list, choose **Discrete random walk**.
- 6 From the **k** list, choose **Turbulent kinetic energy (spf)**.
- 7 From the  $\epsilon$  list, choose **Turbulent dissipation rate (spf/fp l)**.

### Wall 2

- 1 In the **Physics** toolbar, click  **Boundaries** and choose **Wall**.
- 2 Select Boundaries 3 and 14 only.



### Symmetry 1

- 1 In the **Physics** toolbar, click  **Boundaries** and choose **Symmetry**.
- 2 Select Boundaries 1, 4, and 10 only.

### Outlet 1

- 1 In the **Physics** toolbar, click  **Boundaries** and choose **Outlet**.
- 2 Select Boundary 14 only.  
Apply the **Disappear** Wall condition at the outlet to avoid rendering particles that pass through the pipe elbow without hitting the walls.
- 3 In the **Settings** window for **Outlet**, locate the **Outlet** section.
- 4 From the **Wall condition** list, choose **Disappear**.

## ADD STUDY

- 1 In the **Home** toolbar, click  **Add Study** to open the **Add Study** window.
- 2 Go to the **Add Study** window.
- 3 Find the **Studies** subsection. In the **Select Study** tree, select **General Studies** > **Time Dependent**.
- 4 Click the **Add Study** button in the window toolbar.
- 5 In the **Home** toolbar, click  **Add Study** to close the **Add Study** window.

## STUDY 2

### *Step 1: Time Dependent*

- 1 In the **Settings** window for **Time Dependent**, locate the **Study Settings** section.
- 2 In the **Output times** text field, type range (0,5e-3,0.12).
- 3 From the **Tolerance** list, choose **User controlled**.
- 4 In the **Relative tolerance** text field, type 1e-2.
- 5 Locate the **Physics and Variables Selection** section. In the **Solve for** column of the table, under **Component 1 (comp1)**, clear the checkbox for **Turbulent Flow, k- $\omega$  (spf)**.
- 6 Click to expand the **Values of Dependent Variables** section. Find the **Values of variables not solved for** subsection. From the **Settings** list, choose **User controlled**.
- 7 From the **Method** list, choose **Solution**.
- 8 From the **Study** list, choose **Study 1, Stationary**.
- 9 In the **Study** toolbar, click  **Compute**.

## RESULTS

### *Particle Trajectories (fpt)*

In the **Model Builder** window, expand the **Particle Trajectories (fpt)** node.

### *Color Expression 1*

- 1 In the **Model Builder** window, expand the **Results** > **Particle Trajectories (fpt)** > **Particle Trajectories 1** node, then click **Color Expression 1**.
- 2 In the **Settings** window for **Color Expression**, click **Replace Expression** in the upper-right corner of the **Expression** section. From the menu, choose **Component 1 (comp1)** > **Particle Tracing for Fluid Flow** > **Particle properties** > **fpt.phii - Acute angle of incidence - rad**.
- 3 Locate the **Expression** section. From the **Unit** list, choose °.

- 4 In the **Particle Trajectories (fpt)** toolbar, click  **Plot**.

Compare the resulting plot to [Figure 4](#).

Create a **Mirror** dataset to visualize the rate of erosive wear on the surface.



#### *Mirror 3D I*

- 1 In the **Results** toolbar, click  **More Datasets** and choose **Mirror 3D**.
- 2 In the **Settings** window for **Mirror 3D**, locate the **Data** section.
- 3 From the **Dataset** list, choose **Study 2/Solution 2 (sol2)**.

#### *Erosion rate, Finnie*

- 1 In the **Model Builder** window, under **Results** click **Accumulated Variable (fpt)**.
- 2 In the **Settings** window for **3D Plot Group**, type Erosion rate, Finnie in the **Label** text field.
- 3 Locate the **Data** section. From the **Dataset** list, choose **Mirror 3D I**.

#### *Surface I*

- 1 In the **Model Builder** window, expand the **Erosion rate, Finnie** node, then click **Surface I**.
- 2 In the **Settings** window for **Surface**, click to expand the **Quality** section.
- 3 From the **Smoothing** list, choose **Everywhere**.
- 4 In the **Erosion rate, Finnie** toolbar, click  **Plot**.
- 5 Click the  **Zoom Extents** button in the **Graphics** toolbar.  
Compare the resulting plot to [Figure 5](#).

#### *Erosion rate, DNV*

- 1 In the **Model Builder** window, right-click **Erosion rate, Finnie** and choose **Duplicate**.
- 2 In the **Settings** window for **3D Plot Group**, type Erosion rate, DNV in the **Label** text field.

#### *Surface I*

- 1 In the **Model Builder** window, expand the **Erosion rate, DNV** node, then click **Surface I**.
- 2 In the **Settings** window for **Surface**, locate the **Expression** section.
- 3 In the **Expression** text field, type `fpt.wall11.ero2.EM`.
- 4 In the **Erosion rate, DNV** toolbar, click  **Plot**.  
Compare the resulting plot to [Figure 6](#).

#### *Erosion rate, E/CRC*

- 1 In the **Model Builder** window, right-click **Erosion rate, DNV** and choose **Duplicate**.

- 2 In the **Settings** window for **3D Plot Group**, type Erosion rate, E/CRC in the **Label** text field.

#### *Surface 1*

- 1 In the **Model Builder** window, expand the **Erosion rate, E/CRC** node, then click **Surface 1**.
- 2 In the **Settings** window for **Surface**, locate the **Expression** section.
- 3 In the **Expression** text field, type `fpt.wall1.er03.EM`.
- 4 In the **Erosion rate, E/CRC** toolbar, click  **Plot**.

Compare the resulting plot to [Figure 7](#).