



Model created in COMSOL Multiphysics 6.4

Particle Tracing in a Micromixer

Introduction

Micromixers can either be static or dynamic depending on the required mixing time and length scale. For static mixers, the Reynolds number has to be suitably high to induce turbulence-enhanced mixing. Often micromixers operate in the laminar flow regime due to their small characteristic size. The diffusivity of a solute in the flowing fluid may also be extremely small, on the order of 10^{-10} m²/s. This results in mixing length scales on the order of meters — clearly unacceptable for a microscale device. One way to alleviate this problem is to add mixing elements to induce vorticity into the flow. A dynamic mixer uses rotating blades to enhance the mixing process, allowing for smaller-scale devices. The one big disadvantage of a dynamic mixer is that moving parts are required.

Model Definition

This example examines how mixing between microscopic particles occurs in a micromixer. Particles enter the mixer through 3 **Inlet** features and exit through the **Outlet** feature. The particles enter the modeling domain through the inlets in a continuous stream. A new set of particles is released every 50 milliseconds for a total duration of one second. After this, no more particles are released but the model is solved for an additional second. For each release inlet and each release time, 50 particles are released with an initial velocity equal to the fluid velocity, so a total of $3 \times 21 \times 50 = 3150$ particles are released.

The geometry is an assembly containing stationary and rotating domains. The particles are free to cross the pair boundary between the stationary and moving domains as if they were invisible, provided that the **Pair Continuity** feature is used in the Particle Tracing for Fluid Flow interface.

The blades are rotating at a constant angular velocity of 1 revolution per second in the anti-clockwise direction.

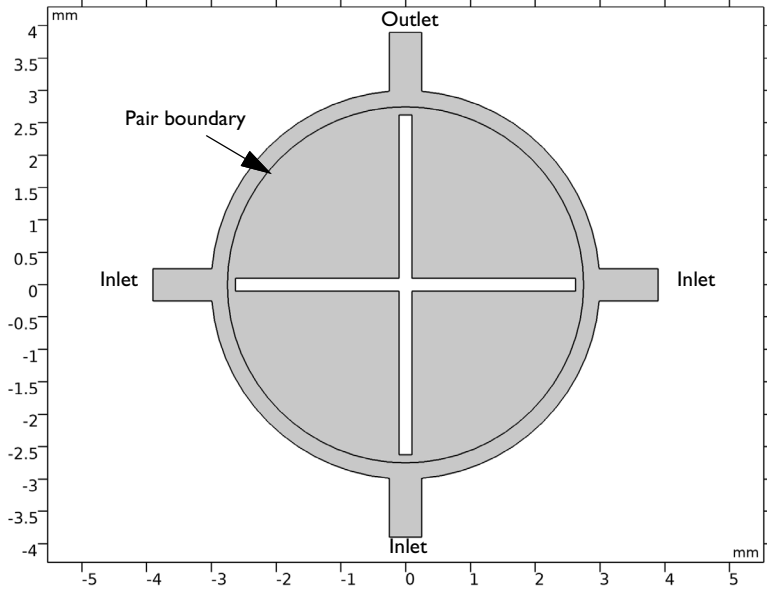

Figure 1: Plot of the model geometry. The geometry length unit is millimeters.

The particles obey Newton's second law:

$$\frac{d}{dt}(m_p \mathbf{v}) = \mathbf{F}_t$$

where

- m_p (SI unit: kg) is the particle mass,
- \mathbf{v} (SI unit: m/s) is the particle velocity, and
- \mathbf{F}_t (SI unit: N) is the total force on the particle.

In this example, the total force is dominated by the **Drag Force** \mathbf{F}_D , for which Stokes's law is

$$\mathbf{F}_D = 3\pi\mu d_p(\mathbf{u} - \mathbf{v})$$

where

- \mathbf{u} (SI unit: m/s) is the fluid velocity,
- μ (SI unit: Pa s) is the fluid dynamic viscosity, and
- d_p (SI unit: m) is the particle diameter.

In addition to the drag force, the optional virtual mass force \mathbf{F}_{vm} and pressure gradient force \mathbf{F}_p on the particle can also be considered. These forces are defined as

$$\begin{aligned}\mathbf{F}_{vm} &= \frac{1}{2}m_f \frac{d(\mathbf{u} - \mathbf{v})}{dt} \\ \mathbf{F}_p &= m_f \frac{D\mathbf{u}}{Dt}\end{aligned}\quad (1)$$

where m_f (SI unit: kg) is the mass of the fluid displaced by the particle volume,

$$m_f = \frac{1}{6}\pi d_p^3 \rho$$

and ρ (SI unit: kg/m³) is the density of the fluid. In [Equation 1](#) the derivative d/dt is a material (or total) derivative in the direction of the particle velocity, and D/Dt is a material derivative in the direction of the fluid velocity. That is, for an arbitrary vector field \mathbf{f} ,

$$\frac{d\mathbf{f}}{dt} = \frac{\partial\mathbf{f}}{\partial t} + \nabla\mathbf{f} \cdot \mathbf{v} \quad \frac{D\mathbf{f}}{Dt} = \frac{\partial\mathbf{f}}{\partial t} + \nabla\mathbf{f} \cdot \mathbf{u}$$

The virtual mass and pressure gradient forces can usually be neglected when the density of the particle phase is much greater than the density of the fluid phase, as is true for solid particles in a gas. However, these forces might approach the same order of magnitude as the drag force if the particles are in a liquid. Particular attention should be paid to these forces when the flow is not stationary, since they each depend on both the spatial and time derivatives of the fluid velocity field.

The flow field is computed using the Laminar Flow interface. The force exerted on the fluid from the particles is neglected in this model. So, it is possible to solve for the flow field only in one study, then use a separate study to compute the particle trajectories based on that flow field. This is usually the recommended approach, if the field is computed from a **Stationary** study. In this case, there are very strong transients in the model, meaning that a huge number of time steps have to be stored if the model is to be solved sequentially. It is more attractive to solve for the particle trajectories and flow field in a single **Time Dependent** study step.

This geometry sequence is treated as an assembly rather than a union, so that the mesh in the inner domain containing the mixing blades can rotate freely. For the fluid flow, the **Flow Continuity** feature must be added on the pair boundaries outside the rotating domain. For the particle tracing, the **Particle Continuity** feature must be used on pairs. The mesh needs to be quite fine on the stationary/sliding interface so that the fluid motion remains continuous. The mesh used in this model is plotted in [Figure 2](#).

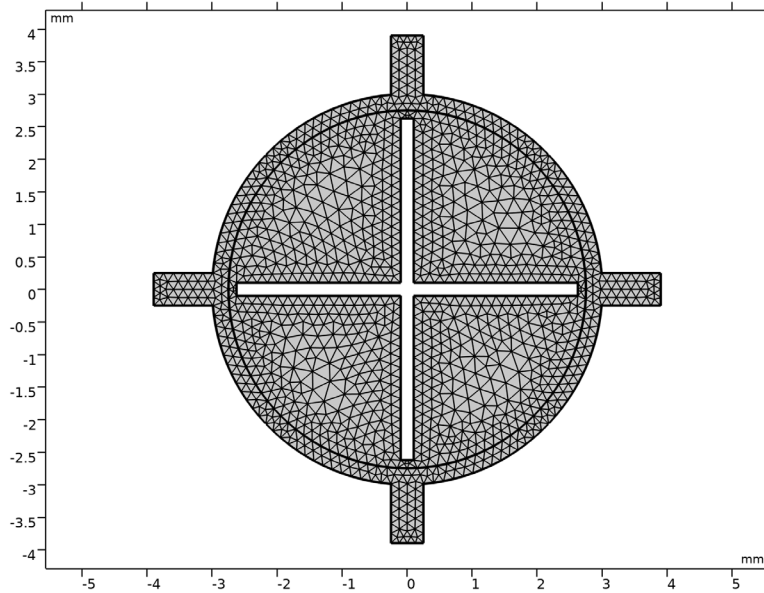

Figure 2: The mesh is quite fine on the pair boundary to accurately resolve the flow field.

Results and Discussion

The location of the particles at different snapshots in time is plotted in Figure 3. The particle color is different for each particle **Inlet**, which conveniently allows the effect of the mixing to be visualized. The particles make their way normally inward from the inlets and, like the fluid velocity, begin to assume a parabolic profile. The particles entering from the left (the blue particles) are then swept downward due to the presence of the rotating blades. However, a few of these particles released at later times actually go clockwise, depending on the exact position of the blades when they first enter the mixer.

The particles entering from the right (red) are swept upward, but some of the particles go past the outlet because of the momentum they gained from the surrounding fluid. At about 0.6 seconds, particles from the bottom inlet (green) begin to reach the outlet as well. Mixing of the three particle streams continues even after new particles stop entering the domain at 1 s. This is because liquid continues to flow in from all of the inlets after the particle stream is terminated, and because the mixing blades continue to rotate.

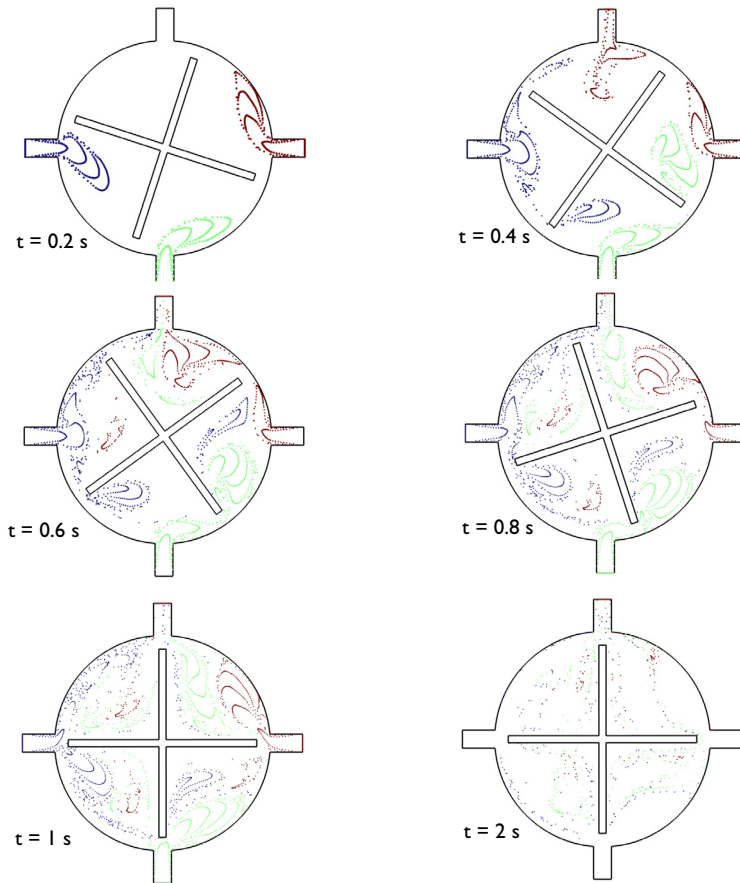

Figure 3: Plot of the particle coordinates at different stages of the mixing process.

Reference

1. G. Karniadakis, A. Beskok, and N. Aluru, *Microflows and Nanoflows*, Springer, 2005.

Application Library path: Particle_Tracing_Module/Fluid_Flow/
micromixer_particle_tracing



Modeling Instructions

From the **File** menu, choose **New**.

NEW

In the **New** window, click  **Model Wizard**.

MODEL WIZARD



- 1 In the **Model Wizard** window, click  **2D**.
- 2 In the **Select Physics** tree, select **Fluid Flow** > **Single-Phase Flow** > **Rotating Machinery, Fluid Flow** > **Laminar Flow**.
- 3 Click **Add**.
- 4 In the **Select Physics** tree, select **Fluid Flow** > **Particle Tracing** > **Particle Tracing for Fluid Flow (fpt)**.
- 5 Click **Add**.
- 6 Click  **Study**.
- 7 In the **Select Study** tree, select **General Studies** > **Time Dependent**.
- 8 Click  **Done**.

GEOMETRY I

The micromixer is only a few millimeters in size, so change the geometry length unit to millimeters:

- 1 In the **Model Builder** window, under **Component 1 (comp1)** click **Geometry 1**.
- 2 In the **Settings** window for **Geometry**, locate the **Units** section.
- 3 From the **Length unit** list, choose **mm**.

Circle 1 (c1)

- 1 In the **Geometry** toolbar, click  **Circle**.
- 2 In the **Settings** window for **Circle**, locate the **Size and Shape** section.
- 3 In the **Radius** text field, type 3.
- 4 Click  **Build All Objects**.

Circle 2 (c2)

- 1 In the **Geometry** toolbar, click  **Circle**.
- 2 In the **Settings** window for **Circle**, locate the **Size and Shape** section.
- 3 In the **Radius** text field, type 2.75.

4 Click  **Build All Objects**.

Difference 1 (dif1)

1 In the **Geometry** toolbar, click  **Booleans and Partitions** and choose **Difference**.

2 Select the object **c1** only.

3 In the **Settings** window for **Difference**, locate the **Difference** section.

4 Click to select the  **Activate Selection** toggle button for **Objects to subtract**.

5 Select the object **c2** only.

6 Select the **Keep objects to subtract** checkbox.

7 Click  **Build All Objects**.

Rectangle 1 (r1)

1 In the **Geometry** toolbar, click  **Rectangle**.

2 In the **Settings** window for **Rectangle**, locate the **Size and Shape** section.

3 In the **Width** text field, type 0.2.

4 In the **Height** text field, type 5.25.

5 Locate the **Position** section. From the **Base** list, choose **Center**.

6 Click  **Build All Objects**.

Rectangle 2 (r2)

1 In the **Geometry** toolbar, click  **Rectangle**.

2 In the **Settings** window for **Rectangle**, locate the **Size and Shape** section.

3 In the **Width** text field, type 5.25.

4 In the **Height** text field, type 0.2.

5 Locate the **Position** section. From the **Base** list, choose **Center**.

6 Click  **Build All Objects**.

Rectangle 3 (r3)

1 In the **Geometry** toolbar, click  **Rectangle**.

2 In the **Settings** window for **Rectangle**, locate the **Size and Shape** section.



3 In the **Height** text field, type 0.5.

4 Locate the **Position** section. In the **x** text field, type -3.4.



5 From the **Base** list, choose **Center**.

6 Click  **Build All Objects**.



Rotate 1 (rot1)

- 1 In the **Geometry** toolbar, click  **Transforms** and choose **Rotate**.
- 2 Select the object **r3** only.
- 3 In the **Settings** window for **Rotate**, locate the **Rotation** section.
- 4 In the **Angle** text field, type 90 180 270.
- 5 Locate the **Input** section. Select the **Keep input objects** checkbox.
- 6 Click  **Build All Objects**.

Union 1 (uni1)



- 1 In the **Geometry** toolbar, click  **Booleans and Partitions** and choose **Union**.
- 2 Select the objects **dif1**, **r3**, **rot1(1)**, **rot1(2)**, and **rot1(3)** only.
- 3 In the **Settings** window for **Union**, locate the **Union** section.
- 4 Clear the **Keep interior boundaries** checkbox.
- 5 Click  **Build All Objects**.

Difference 2 (dif2)

- 1 In the **Geometry** toolbar, click  **Booleans and Partitions** and choose **Difference**.
- 2 Select the object **c2** only.
- 3 In the **Settings** window for **Difference**, locate the **Difference** section.
- 4 Click to select the  **Activate Selection** toggle button for **Objects to subtract**.
- 5 Select the objects **r1** and **r2** only.
- 6 Click  **Build All Objects**.

Form Union (fin)

The **Rotating Machinery, Laminar Flow** interface requires that a pair is present between the stationary and rotating domains. In order to do this, use the **Assembly** option. This will automatically create **Pair** boundaries between the stationary and rotating domains.

- 1 In the **Model Builder** window, under **Component 1 (comp1) > Geometry 1** click **Form Union (fin)**.
- 2 In the **Settings** window for **Form Union/Assembly**, locate the **Form Union/Assembly** section.
- 3 From the **Action** list, choose **Form an assembly**.
- 4 Click  **Build Selected**.
- 5 Click the  **Zoom Extents** button in the **Graphics** toolbar. The geometry should look like [Figure 1](#).

DEFINITIONS

It is usually convenient to define an explicit selection for the pair boundaries.

Pair boundaries

- 1 In the **Definitions** toolbar, click  **Explicit**.
- 2 In the **Settings** window for **Explicit**, type **Pair boundaries** in the **Label** text field.
- 3 Locate the **Input Entities** section. From the **Geometric entity level** list, choose **Boundary**.
- 4 Select Boundaries 15–18 and 33–36 only.

The easiest way to select these boundaries is to copy the text '15-18, 33-36', click in the selection box, and then press **Ctrl+V**. Alternatively, click the **Paste Selection** button and type or paste the boundary numbers in the dialog that appears.

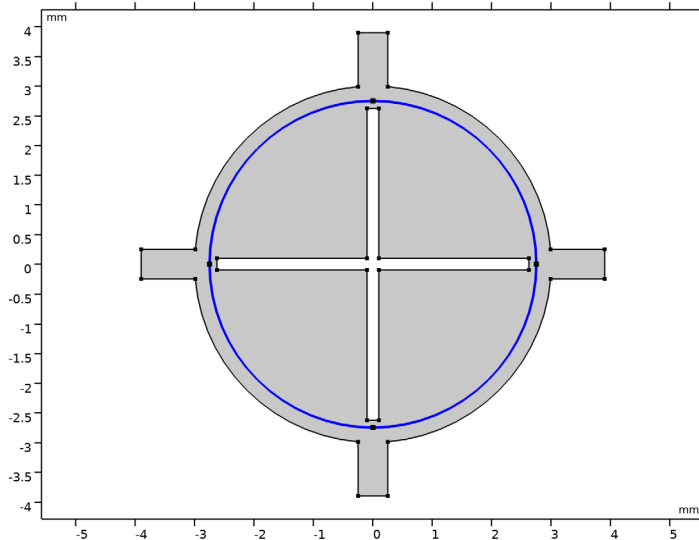

Now define a **Ramp** function for the inlet velocity. The boundary condition for the inlet velocity must be consistent with the initial condition for the velocity. The initial velocity in this model will be zero so the inlet velocity must be ramped up from zero to its maximum value over a certain period of time. In this case the ramp time is 0.01 seconds. To achieve this, the **ramp** function is used with a **slope** of 100, meaning that the ramp function reaches its maximum value after 0.01 seconds.

Ramp 1 (rml)

- 1 In the **Definitions** toolbar, click  **More Functions** and choose **Ramp**.
- 2 In the **Settings** window for **Ramp**, locate the **Parameters** section.

- 3 In the **Slope** text field, type 100.
- 4 Select the **Cutoff** checkbox.
- 5 Click to expand the **Smoothing** section.
- 6 Select the **Size of transition zone at cutoff** checkbox. In the associated text field, type 0.001.

Now that the **Ramp** function is defined, create an expression for the inlet velocity which will ramp up over 0.01 seconds.

Variables 1

- 1 In the **Definitions** toolbar, click \mathcal{A} **Local Variables**.
- 2 In the **Settings** window for **Variables**, locate the **Variables** section.
- 3 In the table, enter the following settings:

Name	Expression	Unit	Description
uin	0.02[m/s]*rm1(t[1/s])	m/s	Inlet velocity

MATERIALS

Material 1 (mat1)

- 1 In the **Model Builder** window, under **Component 1 (comp1)** right-click **Materials** and choose **Blank Material**.
- 2 In the **Settings** window for **Material**, locate the **Material Contents** section.
- 3 In the table, enter the following settings:

Property	Variable	Value	Unit	Property group
Density	rho	1E3	kg/m ³	Basic
Dynamic viscosity	mu	1E-3	Pa·s	Basic

Add a feature which designates the rotating domain. The speed of revolution is also specified, in this case one revolution per unit time. This means the blade system will undergo one complete revolution (360 degrees) per second.

MOVING MESH

Rotating Domain 1

- 1 In the **Model Builder** window, under **Component 1 (comp1)** > **Moving Mesh** click **Rotating Domain 1**.
- 2 In the **Settings** window for **Rotating Domain**, locate the **Domain Selection** section.

- 3 Click  **Clear Selection**.
- 4 Select Domain 2 only.
- 5 Locate the **Rotation** section. In the f text field, type 1.

LAMINAR FLOW (SPF)

Inlet 1

- 1 In the **Physics** toolbar, click  **Boundaries** and choose **Inlet**.
- 2 Select Boundaries 1, 5, and 12 only.
- 3 In the **Settings** window for **Inlet**, locate the **Velocity** section.
- 4 In the U_0 text field, type uin.

Outlet 1

- 1 In the **Physics** toolbar, click  **Boundaries** and choose **Outlet**.
- 2 Select Boundary 7 only.

PARTICLE TRACING FOR FLUID FLOW (FPT)

Wall 1

- 1 In the **Model Builder** window, under **Component 1 (comp1)** > **Particle Tracing for Fluid Flow (fpt)** click **Wall 1**.
- 2 In the **Settings** window for **Wall**, locate the **Wall Condition** section.
- 3 From the **Wall condition** list, choose **Bounce**.



Start by adding the drag force on the particles. This requires input of the fluid velocity and viscosity.

Drag Force 1

- 1 In the **Physics** toolbar, click  **Domains** and choose **Drag Force**.
- 2 In the **Settings** window for **Drag Force**, locate the **Domain Selection** section.
- 3 From the **Selection** list, choose **All domains**.
- 4 Locate the **Drag Force** section. From the **u** list, choose **Velocity field (spf)**.
- 5 From the μ list, choose **Dynamic viscosity (spf/fp1)**.
- 6 Locate the **Additional Terms** section. Select the **Include virtual mass and pressure gradient forces** checkbox.

Now define a stream of particles over the first second for each inlet, with 50 particles per inlet and a new release every 50 milliseconds. Defining 3 separate inlet features will allow for improved visualization during results processing.

Inlet 1

- 1 In the **Physics** toolbar, click  **Boundaries** and choose **Inlet**.
 - 2 Select Boundary 1 only.
 - 3 In the **Settings** window for **Inlet**, locate the **Initial Position** section.
 - 4 From the **Initial position** list, choose **Uniform distribution**.
 - 5 In the N text field, type 50.
 - 6 Locate the **Initial Velocity** section. From the **u** list, choose **Velocity field (spf)**.
 - 7 Locate the **Release Times** section. Click  **Range**.
 - 8 In the **Range** dialog, type 0 in the **Start** text field.
 - 9 In the **Stop** text field, type 1.
 - 10 In the **Step** text field, type 0.05.
- II Click **Replace**.

Inlet 2

- 1 Right-click **Inlet 1** and choose **Duplicate**.
- 2 Select Boundary 5 only.

Inlet 3

- 1 Right-click **Inlet 2** and choose **Duplicate**.
- 2 Select Boundary 12 only.

Outlet 1

- 1 In the **Physics** toolbar, click  **Boundaries** and choose **Outlet**.
- 2 Select Boundary 7 only.

Particle Properties 1

- 1 In the **Model Builder** window, click **Particle Properties 1**.
- 2 In the **Settings** window for **Particle Properties**, locate the **Particle Properties** section.
- 3 From the ρ_p list, choose **User defined**. In the d_p text field, type 10[um].

MESH 1

A reasonably fine mesh is needed on the interface between the stationary and rotating domains.

Edge 1

- 1 In the **Mesh** toolbar, click  **More Generators** and choose **Edge**.
- 2 In the **Settings** window for **Edge**, locate the **Boundary Selection** section.
- 3 From the **Selection** list, choose **All boundaries**.



Size 1

- 1 Right-click **Edge 1** and choose **Size**.
- 2 In the **Settings** window for **Size**, locate the **Element Size** section.
- 3 From the **Predefined** list, choose **Extra fine**.

Free Triangular 1

In the **Mesh** toolbar, click  **Free Triangular**.

Size

- 1 In the **Model Builder** window, click **Size**.
- 2 In the **Settings** window for **Size**, locate the **Element Size** section.
- 3 From the **Predefined** list, choose **Finer**.
- 4 Click  **Build All**.
- 5 Click the  **Zoom Extents** button in the **Graphics** toolbar. The mesh should look like [Figure 2](#).

STUDY 1

Step 1: Time Dependent

- 1 In the **Model Builder** window, under **Study 1** click **Step 1: Time Dependent**.
- 2 In the **Settings** window for **Time Dependent**, locate the **Study Settings** section.
- 3 In the **Output times** text field, type range (0, 0.02, 2).
- 4 From the **Tolerance** list, choose **User controlled**.
- 5 In the **Study** toolbar, click  **Compute**.

RESULTS

Particle Trajectories (fpt)

The predefined variable `fpt.prf` can be used to place colors on a particle based on the inlet where it appeared. This allows you to visualize the effect of the mixing between the three inlets.

- 1 Click the  **Zoom Extents** button in the **Graphics** toolbar.

Particle Trajectories I

In the **Model Builder** window, expand the **Particle Trajectories (fpt)** node.

Color Expression I

- 1 In the **Model Builder** window, expand the **Particle Trajectories I** node, then click **Color Expression I**.
- 2 In the **Settings** window for **Color Expression**, click **Replace Expression** in the upper-right corner of the **Expression** section. From the menu, choose **Component I (comp1) > Particle Tracing for Fluid Flow > Particle statistics > fpt.prf - Particle release feature - I**.
- 3 In the **Particle Trajectories (fpt)** toolbar, click  **Plot**.

Hide the pair boundary using the **Hide Geometric Entities** option in the **View** node.

DEFINITIONS

Hide for Physics I

- 1 In the **Model Builder** window, expand the **Component I (comp1) > Definitions > View I** node.
- 2 Right-click **View I** and choose **Hide for Physics**.
- 3 In the **Settings** window for **Hide for Physics**, locate the **Geometric Entity Selection** section.
- 4 From the **Geometric entity level** list, choose **Boundary**.
- 5 From the **Selection** list, choose **Pair boundaries**.

RESULTS

Particle Trajectories (fpt)

You can reproduce the results in [Figure 3](#) by selecting different values for Time. A better way of visualizing the results is to click the **Player** button, in which case the following instructions can be skipped.

- 1 In the **Model Builder** window, under **Results** click **Particle Trajectories (fpt)**.
- 2 In the **Settings** window for **2D Plot Group**, locate the **Data** section.
- 3 From the **Time (s)** list, choose **0.2**.
- 4 In the **Particle Trajectories (fpt)** toolbar, click  **Plot**.

Repeat last two steps for the time values 0.4, 0.6, 0.8, 1, and 2 s.