



Model created in COMSOL Multiphysics 6.4

Parameter Optimization of a Tesla Microvalve

Introduction

A Tesla valve inhibits backward flow on a fixed geometry by utilizing friction forces instead of moving parts, [Ref. 1](#). This means fluid can flow freely in one direction but not in the reverse direction. This model sets up a parameter optimization model with inspiration from the model [Optimization of a Tesla Microvalve](#), which finds a design for a Tesla valve using topology optimization. This model takes uncertainties in the form of erosion and dilation of the geometry into account using a parametric sweep and optimizes for the worst of three possible geometries.

Model Definition

The physics of this model is identical to that of [Optimization of a Tesla Microvalve](#), so the main difference is in the setup of the parameterized geometry. The result of the topology optimization is shown in [Figure 1](#), while the parameterized geometry for this model is shown in [Figure 2](#).

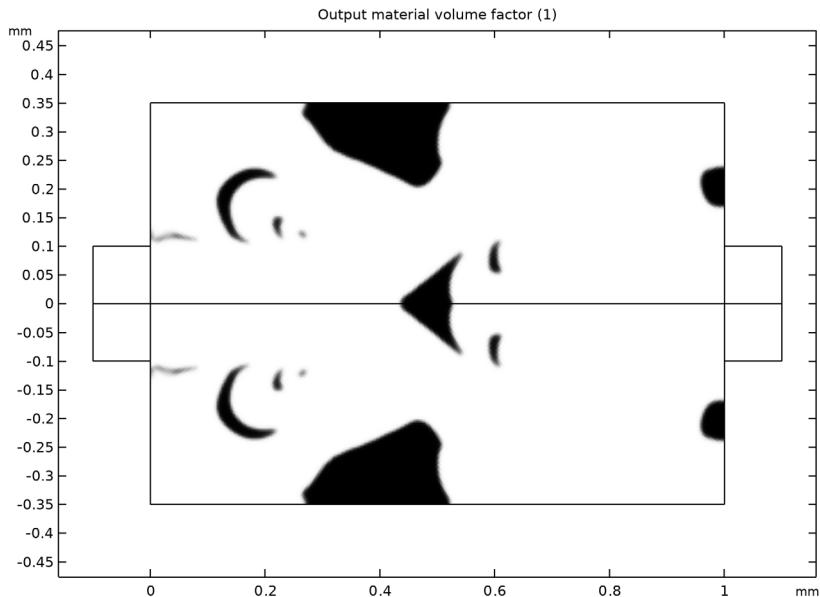

Figure 1: The topology optimized design computed in the model, [Optimization of a Tesla Microvalve](#).

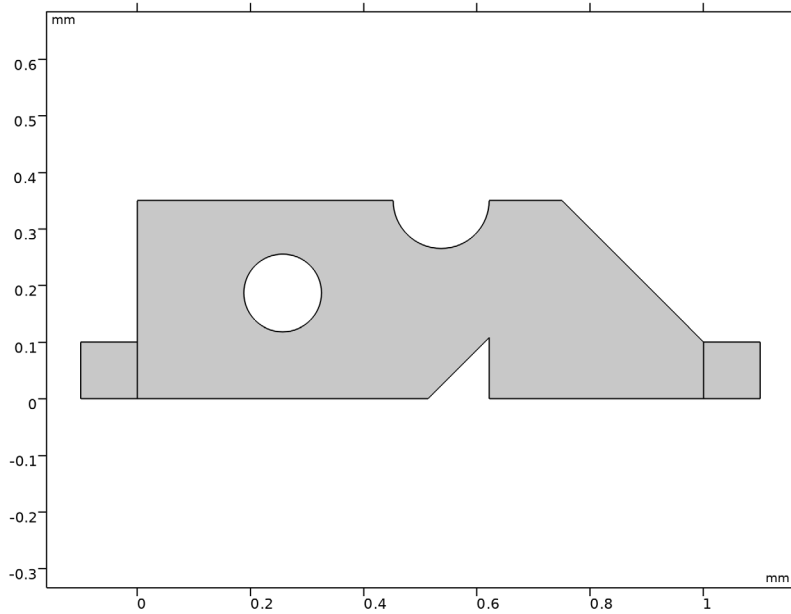

Figure 2: The parameterized geometry used for this model is simple to allow for the use of a derivative free solver. Only half of the geometry is modeled, because this saves computational time.

The model is parameterized such that the topology of the geometry is fixed, while still allowing for the use of box constraints for the parameters. The erosion and dilation is implemented via the `error` parameter, which is used to scale the circles and the triangle. This parameter is then varied in a parametric sweep such that three different geometries are generated for every optimization iteration. Only the worst performing design is used to drive the optimization, but the worst design changes between the eroded and dilated design, so the sweep is needed for considering all three designs in every optimization iteration.

Results and Discussion

The result of the optimization is shown in [Figure 3](#). As expected, it is not possible to achieve the same performance as for the topology optimized design, because the number of design variables goes from thousands to three. Therefore, the diodicity drops from 2.34 to 2.20 for the blue print design and 2.1 for the eroded/dilated designs.

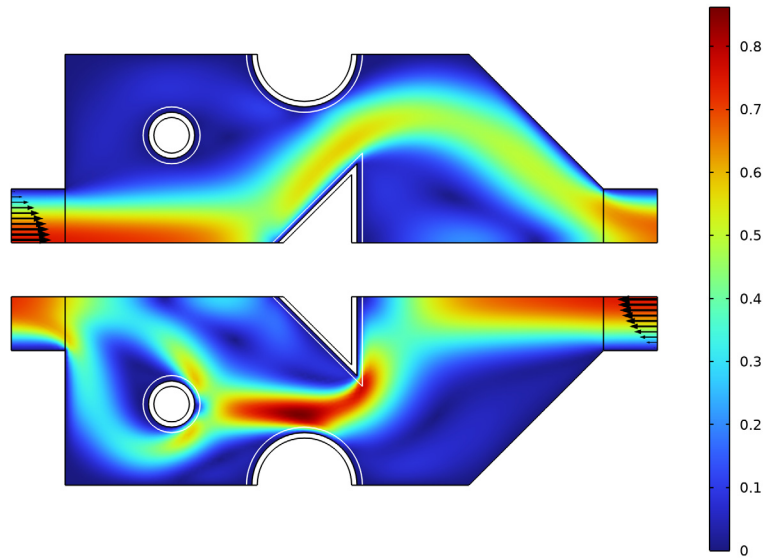

Figure 3: The forward and backward flow is shown in the same plot for the blue print design. The eroded and dilated geometries are shown with black and white lines, respectively.

Reference

1. S. Lin, “Topology Optimization of Micro Tesla Valve in low and moderate Reynolds number,” Chinese Academy of Sciences, China, September 27, 2011.

Notes About the COMSOL Implementation

The model is set up using two Laminar Flow interfaces, one for the forward flow and one for the reverse.

Application Library path: Optimization_Module/Design_Optimization/
tesla_microvalve_parameter_optimization



Modeling Instructions

From the **File** menu, choose **New**.

NEW



In the **New** window, click  **Model Wizard**.

MODEL WIZARD

- 1 In the **Model Wizard** window, click  **2D**.
- 2 In the **Select Physics** tree, select **Fluid Flow** > **Single-Phase Flow** > **Laminar Flow (spf)**.
- 3 Click **Add**.
- 4 Click **Add**.
- 5 Click  **Study**.
- 6 In the **Select Study** tree, select **General Studies** > **Stationary**.
- 7 Click  **Done**.

GEOMETRY I

Create the geometry. To simplify this step, insert a prepared geometry sequence.

- 1 In the **Geometry** toolbar, click **Insert Sequence** and choose **Insert Sequence**.
- 2 Browse to the model's Application Libraries folder and double-click the file `tesla_microvalve_parameter_optimization_geom_sequence.mph`.
- 3 In the **Geometry** toolbar, click  **Build All**.
- 4 Click the  **Zoom Extents** button in the **Graphics** toolbar.

5 In the **Model Builder** window, under **Component 1 (comp1)** click **Geometry 1**.

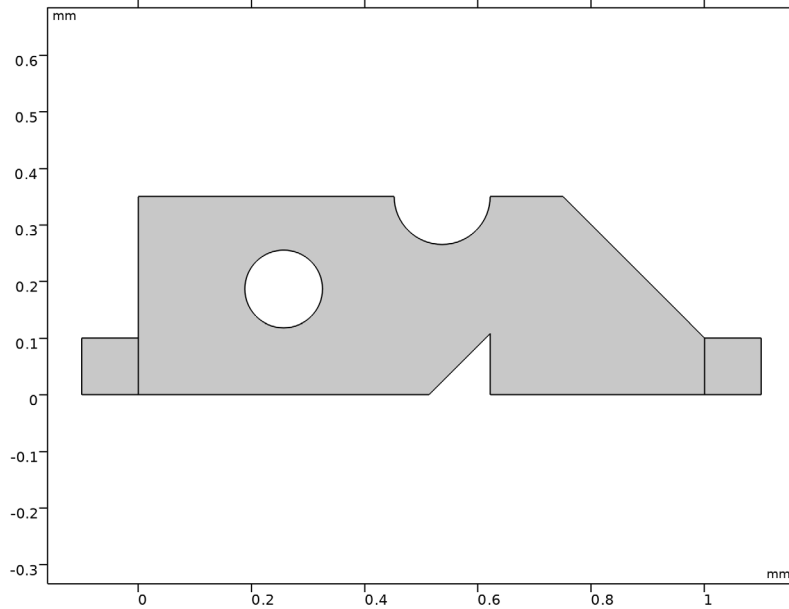

The geometry should now look like that in [Figure 1](#). Note that the inserted geometry is parameterized and that the parameters used are automatically added to the list of global parameters in the model.

6 In the **Model Builder** window, collapse the **Geometry 1** node.

GLOBAL DEFINITIONS

Geometrical Parameters

Add a new parameter group for calculating the average inlet velocity as a function of the Reynolds number.

1 In the **Model Builder** window, under **Global Definitions** click **Parameters 1**.

2 In the **Settings** window for **Parameters**, type Geometrical Parameters in the **Label** text field.

Parameters 2

1 In the **Home** toolbar, click **P_i Parameters** and choose **Add > Parameters**.

2 In the **Settings** window for **Parameters**, locate the **Parameters** section.

3 In the table, enter the following settings:

Name	Expression	Value	Description
Re	100	100	Reynolds number
mu0	1e-3[Pa*s]	0.001 Pa*s	Dynamic viscosity
rho0	1e3[kg/m^3]	1000 kg/m ³	Density
Uin	Re*mu0/(rho0*D)	0.5 m/s	Average inlet velocity
meshsz	0.01 [mm]	1E-5 m	Mesh size

DEFINITIONS

Add the same nonlocal couplings and variables as for the topology optimization.

Average 1 (aveop1)

- 1 In the **Definitions** toolbar, click  **Nonlocal Couplings** and choose **Average**.
- 2 In the **Settings** window for **Average**, locate the **Source Selection** section.
- 3 From the **Geometric entity level** list, choose **Boundary**.
- 4 From the **Selection** list, choose **Left**.

Average 2 (aveop2)

- 1 In the **Definitions** toolbar, click  **Nonlocal Couplings** and choose **Average**.
- 2 In the **Settings** window for **Average**, locate the **Source Selection** section.
- 3 From the **Geometric entity level** list, choose **Boundary**.
- 4 From the **Selection** list, choose **Right**.

Integration 1 (intop1)

- 1 In the **Definitions** toolbar, click  **Nonlocal Couplings** and choose **Integration**.
- 2 Select Domain 2 only.

Variables 1

- 1 In the **Model Builder** window, right-click **Definitions** and choose **Variables**.
- 2 In the **Settings** window for **Variables**, locate the **Variables** section.

3 In the table, enter the following settings:

Name	Expression	Unit	Description
dP_forward	aveop1(p) - aveop2(p)	Pa	Pressure difference, forward direction
dP_backward	aveop2(p2) - aveop1(p2)	Pa	Pressure difference, backward direction
Di	dP_backward / dP_forward		Ratio of pressure differences

MATERIALS

Material 1 (mat1)

- 1 In the **Model Builder** window, under **Component 1 (comp1)** right-click **Materials** and choose **Blank Material**.
- 2 In the **Settings** window for **Material**, locate the **Material Contents** section.
- 3 In the table, enter the following settings:

Property	Variable	Value	Unit	Property group
Density	rho	rho0	kg/m ³	Basic
Dynamic viscosity	mu	mu0	Pa·s	Basic

LAMINAR FLOW (SPF)

Set up the same boundary conditions as for the topology optimization model.

Wall 2

- 1 In the **Physics** toolbar, click  **Boundaries** and choose **Wall**.
- 2 In the **Settings** window for **Wall**, locate the **Boundary Selection** section.
- 3 From the **Selection** list, choose **Symmetry**.
- 4 Locate the **Boundary Condition** section. From the **Wall condition** list, choose **Slip**.

Inlet 1

- 1 In the **Physics** toolbar, click  **Boundaries** and choose **Inlet**.
- 2 In the **Settings** window for **Inlet**, locate the **Boundary Selection** section.
- 3 From the **Selection** list, choose **Left**.
- 4 Locate the **Boundary Condition** section. From the list, choose **Fully developed flow**.
- 5 Locate the **Fully Developed Flow** section. In the U_{av} text field, type U_{in} .

Outlet 1

- 1 In the **Physics** toolbar, click  **Boundaries** and choose **Outlet**.
- 2 In the **Settings** window for **Outlet**, locate the **Boundary Selection** section.
- 3 From the **Selection** list, choose **Right**.

LAMINAR FLOW 2 (SPF2)

Wall 2

- 1 In the **Physics** toolbar, click  **Boundaries** and choose **Wall**.
- 2 In the **Settings** window for **Wall**, locate the **Boundary Selection** section.
- 3 From the **Selection** list, choose **Symmetry**.
- 4 Locate the **Boundary Condition** section. From the **Wall condition** list, choose **Slip**.

Inlet 1

- 1 In the **Physics** toolbar, click  **Boundaries** and choose **Inlet**.
- 2 In the **Settings** window for **Inlet**, locate the **Boundary Selection** section.
- 3 From the **Selection** list, choose **Right**.
- 4 Locate the **Boundary Condition** section. From the list, choose **Fully developed flow**.
- 5 Locate the **Fully Developed Flow** section. In the U_{av} text field, type **Uin**.

Outlet 1

- 1 In the **Physics** toolbar, click  **Boundaries** and choose **Outlet**.
- 2 In the **Settings** window for **Outlet**, locate the **Boundary Selection** section.
- 3 From the **Selection** list, choose **Left**.

MESH 1

Generate an isotropic mesh with a minimum length scale of meshsz.

Free Triangular 1

In the **Mesh** toolbar, click  **Free Triangular**.

Size

- 1 In the **Model Builder** window, click **Size**.
- 2 In the **Settings** window for **Size**, locate the **Element Size** section.
- 3 From the **Predefined** list, choose **Extremely fine**.
- 4 Click the **Custom** button.

5 Locate the **Element Size Parameters** section. In the **Maximum element size** text field, type meshsz.

6 Click  **Build All**.

STUDY 1: INITIAL DESIGN

Compute the flow and diodicity (D_i) for the initial design.

1 In the **Model Builder** window, click **Study 1**.

2 In the **Settings** window for **Study**, type Study 1: Initial design in the **Label** text field.

3 In the **Study** toolbar, click  **Compute**.

RESULTS

Global Evaluation 1

1 In the **Results** toolbar, click  **Global Evaluation**.

2 In the **Settings** window for **Global Evaluation**, locate the **Expressions** section.

3 In the table, enter the following settings:

Expression	Unit	Description
D_i	1	Ratio of pressure differences

Pressure (spf), Pressure (spf2), Velocity (spf), Velocity (spf2)

1 In the **Model Builder** window, under **Results**, Ctrl-click to select **Velocity (spf)**, **Pressure (spf)**, **Velocity (spf2)**, and **Pressure (spf2)**.

2 Right-click and choose **Group**.

Initial Design

In the **Settings** window for **Group**, type Initial Design in the **Label** text field.

ROOT

Add a second study for the parameter optimization.

ADD STUDY

1 In the **Home** toolbar, click  **Add Study** to open the **Add Study** window.

2 Go to the **Add Study** window.

3 Find the **Studies** subsection. In the **Select Study** tree, select **General Studies > Stationary**.

4 Click the **Add Study** button in the window toolbar.

5 In the **Home** toolbar, click  **Add Study** to close the **Add Study** window.

STUDY 2

Parameter Optimization

1 In the **Study** toolbar, click  **Optimization** and choose **Parameter Optimization**.

Use continuation in the Reynolds number to improve stability.

2 In the **Settings** window for **Parameter Optimization**, click **Add Expression** in the upper-right corner of the **Objective Function** section. From the menu, choose **Component 1 (comp1) > Definitions > Variables > comp1.Di - Ratio of pressure differences - I**.

3 Locate the **Objective Function** section. From the **Type** list, choose **Maximization**.

4 Locate the **Control Parameters** section. Click  **Add** three times.

5 In the table, enter the following settings:

Parameter	Initial value	Lower bound	Upper bound	Unit
aLT (Triangle size parameter (0<aLT<1))	0.4	0.01	0.99	
aR (Upper circle radius parameter (0<aR<1))	0.4	0.01	0.99	
aXT (Triangle position parameter (a<aXT<1))	0.5	0.01	0.99	

Step 1: Stationary

1 In the **Model Builder** window, click **Step 1: Stationary**.

2 In the **Settings** window for **Stationary**, click to expand the **Study Extensions** section.

3 Select the **Auxiliary sweep** checkbox.



4 Click  **Add**.

5 In the table, enter the following settings:

Parameter name	Parameter value list	Parameter unit
Re (Reynolds number)	50 100	

Add a **Parametric sweep** to take under- and overetching into account.

Parametric Sweep

- 1 In the **Study** toolbar, click  **Parametric Sweep**.
- 2 In the **Settings** window for **Parametric Sweep**, locate the **Study Settings** section.
- 3 Click  **Add**.
- 4 In the table, enter the following settings:

Parameter name	Parameter value list	Parameter unit
error (+/- tol)	-tol 0 tol	m

Generate default plots to use while solving and use the worst solution to drive the optimization.

- 5 In the **Model Builder** window, click **Study 2**.
- 6 In the **Settings** window for **Study**, type Study 2: Optimization in the **Label** text field.
- 7 In the **Study** toolbar, click  **Get Initial Value**.

Parameter Optimization

- 1 In the **Model Builder** window, click **Parameter Optimization**.
- 2 In the **Settings** window for **Parameter Optimization**, locate the **Objective Function** section.
- 3 From the **Solution** list, choose **Use last**.
- 4 From the **Outer solution** list, choose **Minimum of objectives**.
- 5 Click to expand the **Output** section. Select the **Plot** checkbox.
- 6 In the table, enter the following settings:

Plot group	Plot window
Velocity (spf2) I	Graphics

- 7 In the **Study** toolbar, click  **Compute**.

Evaluate the diodicity again.

RESULTS

Global Evaluation I

- 1 In the **Model Builder** window, under **Results** > **Derived Values** click **Global Evaluation I**.
- 2 In the **Settings** window for **Global Evaluation**, locate the **Data** section.
- 3 From the **Dataset** list, choose **Study 2: Optimization/Parametric Solutions I (sol3)**.
- 4 Click  **Evaluate**.

Pressure (spf) I, Pressure (spf2) I, Velocity (spf) I, Velocity (spf2) I

1 In the **Model Builder** window, under **Results**, Ctrl-click to select **Velocity (spf) I**, **Pressure (spf) I**, **Velocity (spf2) I**, and **Pressure (spf2) I**.

2 Right-click and choose **Group**.

Optimized

In the **Settings** window for **Group**, type **Optimized** in the **Label** text field.

Geometry Modeling Instructions

If you want to create the geometry yourself, follow these steps.

ADD COMPONENT

In the **Home** toolbar, click  **Add Component** and choose **2D**.

GLOBAL DEFINITIONS

Parameters I

1 In the **Model Builder** window, under **Global Definitions** click **Parameters I**.

2 In the **Settings** window for **Parameters**, locate the **Parameters** section.

3 In the table, enter the following settings:

Name	Expression	Value	Description
L	1 [mm]	0.001 m	Channel length
D	0.2 [mm]	2E-4 m	Characteristic dimension
H	1.75*D	3.5E-4 m	Channel width
tol	10 [μm]	1E-5 m	length tolerance
error	0 [m]	0 m	+/- tol
aLT	0.4	0.4	Triangle size parameter (0<aLT<1)
LT	(H-8*tol)*aLT	1.08E-4 m	Triangle length and width
aXT	0.5	0.5	Triangle position parameter (a<aXT<1)
XT	R+5*tol+(L-LT-R-5*tol)*aXT	5.134E-4 m	Triangle position
YC	0.5*(LT+H-R)	1.866E-4 m	Middle circle Y position

Name	Expression	Value	Description
aRC	1	1	Middle circle radius parameter ($0 < aRC < 1$)
RC	$(H - LT - R - 2 * t_{ol}) / 2 * aRC$	6.86E-5 m	Middle circle radius
aR	0.4	0.4	Upper circle radius parameter ($0 < aR < 1$)
R	$(H - LT - 3 * t_{ol}) * aR$	8.48E-5 m	Upper half circle radius
XC	$\max(XT / 2, RC + 2 * t_{ol})$	2.567E-4 m	Middle circle X position

Use the parameters to set up a parameterized geometry with selections for the inlet, outlet and the symmetry boundary.

GEOMETRY I

- 1 In the **Model Builder** window, under **Component 1 (comp1)** click **Geometry 1**.
- 2 In the **Settings** window for **Geometry**, locate the **Units** section.
- 3 From the **Length unit** list, choose **mm**.

Rectangle 1 (r1)

- 1 In the **Geometry** toolbar, click  **Rectangle**.
- 2 In the **Settings** window for **Rectangle**, locate the **Size and Shape** section.
- 3 In the **Height** text field, type H.

Rectangle 2 (r2)

- 1 In the **Geometry** toolbar, click  **Rectangle**.
- 2 In the **Settings** window for **Rectangle**, locate the **Size and Shape** section.
- 3 In the **Height** text field, type D/2.
- 4 In the **Width** text field, type D/2.
- 5 Locate the **Position** section. In the **x** text field, type -D/2.

Rectangle 3 (r3)

- 1 In the **Geometry** toolbar, click  **Rectangle**.
- 2 In the **Settings** window for **Rectangle**, locate the **Position** section.
- 3 In the **x** text field, type L.
- 4 Locate the **Size and Shape** section. In the **Height** text field, type D/2.
- 5 In the **Width** text field, type D/2.

Polygon 1 (poll)

- 1 In the **Geometry** toolbar, click  **Polygon**.
- 2 In the **Settings** window for **Polygon**, locate the **Coordinates** section.
- 3 In the table, enter the following settings:

x (mm)	y (mm)
XT	0
XT+LT	LT
XT+LT	0

Scale 1 (sca1)

- 1 In the **Geometry** toolbar, click  **Transforms** and choose **Scale**.
- 2 Select the object **poll** only.
- 3 In the **Settings** window for **Scale**, locate the **Scale Factor** section.
- 4 In the **Factor** text field, type $(LT/2+error)/LT*2$.
- 5 Locate the **Center of Scaling** section. In the **x** text field, type $XT+LT/2$.

Circle 1 (c1)

- 1 In the **Geometry** toolbar, click  **Circle**.
- 2 In the **Settings** window for **Circle**, locate the **Position** section.
- 3 In the **x** text field, type $XT+LT-R$.
- 4 Locate the **Size and Shape** section. In the **Radius** text field, type **R**.
- 5 Locate the **Position** section. In the **y** text field, type **H**.

Scale 2 (sca2)

- 1 In the **Geometry** toolbar, click  **Transforms** and choose **Scale**.
- 2 Select the object **c1** only.
- 3 In the **Settings** window for **Scale**, locate the **Scale Factor** section.
- 4 In the **Factor** text field, type $(R+error)/R$.
- 5 Locate the **Center of Scaling** section. In the **x** text field, type $XT+LT-R$.
- 6 In the **y** text field, type **H**.

Circle 2 (c2)

- 1 In the **Geometry** toolbar, click  **Circle**.
- 2 In the **Settings** window for **Circle**, locate the **Size and Shape** section.
- 3 In the **Radius** text field, type **RC**.

- 4 Locate the **Position** section. In the **x** text field, type XC.
- 5 In the **y** text field, type YC.

Scale 3 (sca3)



- 1 In the **Geometry** toolbar, click  **Transforms** and choose **Scale**.
- 2 Select the object **c2** only.
- 3 In the **Settings** window for **Scale**, locate the **Scale Factor** section.
- 4 In the **Factor** text field, type $(RC+error)/RC$.
- 5 Locate the **Center of Scaling** section. In the **x** text field, type XC.
- 6 In the **y** text field, type YC.

Polygon 2 (pol2)

- 1 In the **Geometry** toolbar, click  **Polygon**.
- 2 In the **Settings** window for **Polygon**, locate the **Coordinates** section.
- 3 In the table, enter the following settings:

x (mm)	y (mm)
L	D/2
L	H
$L-H+D/2$	H

Difference 1 (dif1)

- 1 In the **Geometry** toolbar, click  **Booleans and Partitions** and choose **Difference**.
- 2 Select the object **r1** only.
- 3 In the **Settings** window for **Difference**, locate the **Difference** section.
- 4 Click to select the  **Activate Selection** toggle button for **Objects to subtract**.
- 5 Select the objects **pol2**, **sca1**, **sca2**, and **sca3** only.





Right

- 1 In the **Geometry** toolbar, click  **Selections** and choose **Box Selection**.
- 2 In the **Settings** window for **Box Selection**, type Right in the **Label** text field.
- 3 Locate the **Geometric Entity Level** section. From the **Level** list, choose **Boundary**.
- 4 Locate the **Box Limits** section. In the **x minimum** text field, type $L+D/2-1e3*eps$.
- 5 Locate the **Output Entities** section. From the **Include entity if** list, choose **Entity inside box**.

Left

- 1 In the **Geometry** toolbar, click  **Selections** and choose **Box Selection**.
- 2 In the **Settings** window for **Box Selection**, type **Left** in the **Label** text field.
- 3 Locate the **Geometric Entity Level** section. From the **Level** list, choose **Boundary**.
- 4 Locate the **Box Limits** section. In the **x maximum** text field, type $-D/2+1e3*\text{eps}$.
- 5 Locate the **Output Entities** section. From the **Include entity if** list, choose **Entity inside box**.

Symmetry

- 1 In the **Geometry** toolbar, click  **Selections** and choose **Box Selection**.
- 2 In the **Settings** window for **Box Selection**, locate the **Geometric Entity Level** section.
- 3 From the **Level** list, choose **Boundary**.
- 4 In the **Label** text field, type **Symmetry**.
- 5 Locate the **Box Limits** section. In the **x maximum** text field, type $1e3*\text{eps}$.
- 6 Locate the **Output Entities** section. From the **Include entity if** list, choose **Entity inside box**.
- 7 Locate the **Box Limits** section. In the **x maximum** text field, type **Inf**.
- 8 In the **y maximum** text field, type $1e3*\text{eps}$.
- 9 Click  **Build All Objects**.
- 10 Click the  **Zoom Extents** button in the **Graphics** toolbar.
- 11 In the **Geometry** toolbar, click  **Build All**.

The model geometry is now complete.