



Model created in COMSOL Multiphysics 6.4

# Exporting and Importing a Topology-Optimized Hook

## *Introduction*

---

Topology optimization in a structural mechanics context can answer the question: Given that you know the loads on the structure, which distribution of the available material maximizes stiffness? Or, conversely, how much material is necessary to obtain a predefined stiffness, and how should it be distributed? Such investigations typically occur during the concept design stages.

The conflicting goals of stiffness maximization and mass minimization lead to a continuum of possible optimal solutions, depending on how you balance the goals against each other. This topology optimization example demonstrates how to use a penalization method (SIMP) to obtain an optimal distribution of a fixed amount of material such that stiffness is maximized. Changing the amount of material available leads to a different solution, which is also Pareto optimal, representing a different balance between the conflicting objectives.

## *Model Definition*

---

The model studies optimal material distribution in a hook, which is symmetric about the plane  $z = 0$  and consists of a linear elastic material, structural steel. It is subjected to two distributed load cases: One at the tip of the hook and one along its lower inner curve. The geometry is imported as a geometry sequence ([Figure 1](#)).

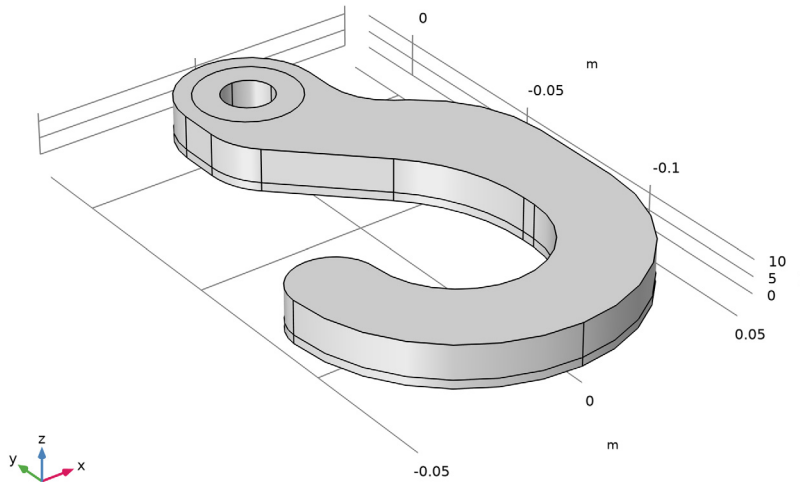
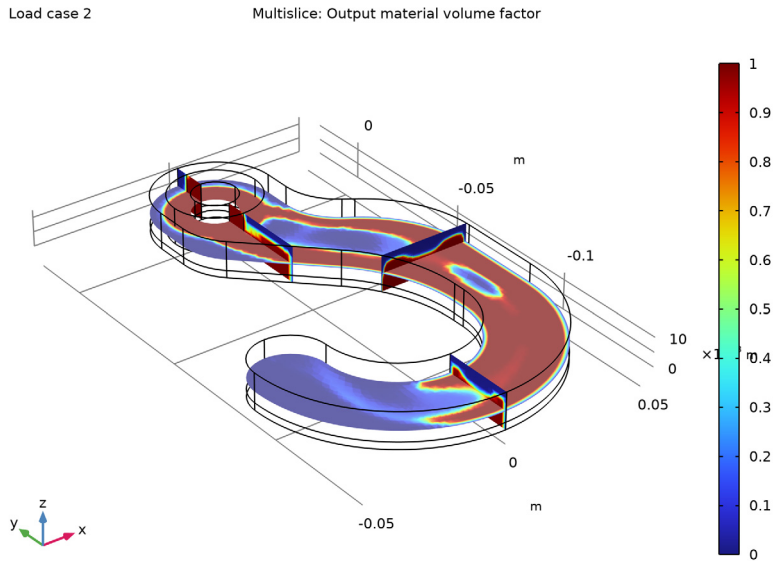

*Figure 1: The computational domain of the hook is reduced by exploiting symmetry.*

The optimality criterion is defined by the objective function, which in this example is chosen to be the total strain energy. Note that the strain energy exactly balances the work done by the applied load, so minimizing the strain energy minimizes the displacement induced at the points where loads are applied, effectively minimizing the compliance of the structure — maximizing its stiffness. The other, conflicting, objective is minimization of total mass, which is implemented as an upper bound on the mass of the optimized structure.

To regularize the problem we introduce a minimum length scale via a filter radius in a Helmholtz filter. See the [Topology Optimization of an MBB Beam](#) example for illustrations of this process. Ideally, the topology of the resulting designs should be mesh independent and for designs with moderate complexity this can be achieved, but if the optimal design is very complex, other designs with slightly different topologies perform only marginally worse, so the optimization problem has many local minima, and it is likely

that a slightly suboptimal design is identified. The result of the optimization is shown in [Figure 2](#).



*Figure 2: A multislice plot colored with the displacement magnitude shows the topology optimized design before it is exported.*

In this example the complexity of the design is constrained using milling constraints, see [Ref. 4](#) or [Topology Optimization of a Beam with Milling Constraints](#) for details. The example demonstrates a strategy based on using MMA with a limited number of iterations. The filtered variable is solved on a finer mesh to get a smooth design for postprocessing. You can use this to export a STL file, but to transfer the geometry to a second component for verification purposes, it is best to use a **Filter** dataset. This approach enables the recycling of selections from the other component, but the parameters for the geometry **Import** feature can still require some tweaking to get a valid mesh for computation of the displacements in the imported geometry.

## Results

---

The following plot shows the displacement field for the optimized solution after the geometry has been transferred and remeshed.

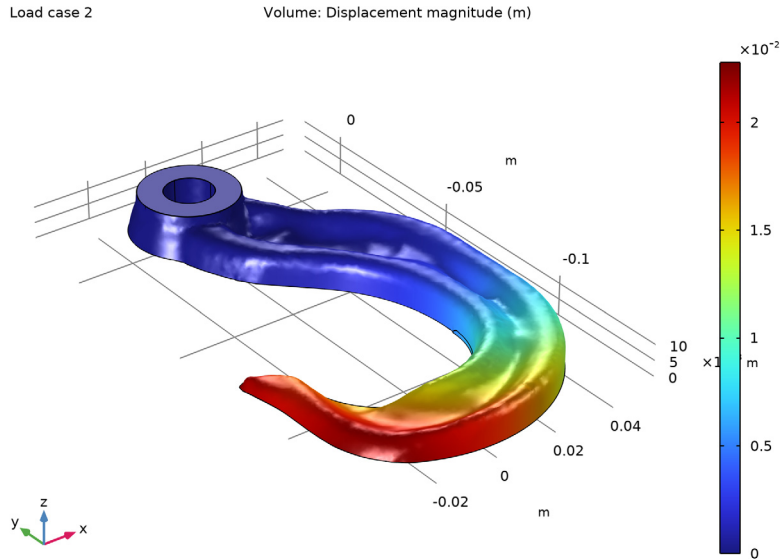

*Figure 3: A plot of the displacement field for the optimized design after it has been imported as an STL file.*

## Notes About the COMSOL Implementation

---

The control variable field, Helmholtz filter, and SIMP penalization are defined through the use of a **Density Model** feature. A Solid Mechanics interface represents the structural properties of the beam, while the objective and the constraints are defined directly in the **Topology Optimization** study step. The elastic strain energy density is a predefined variable, `solid.Ws`, available to use as the objective function for the optimization problem.

It is sufficient to include only half of the hook geometry in the model because of the assumed symmetry, which is implemented as a Symmetry condition on the symmetry plane. Results plots and inspection of the solution while solving are set up using a Mirror dataset to show the complete solution. The geometry is parameterized, making it easy to experiment with different hook sizes, but keep in mind that the mesh size is taken as the filter radius.

The optimization solver is selected and controlled from the study step. For topology optimization, either of the MMA, IPOPT, or GCMMA solver can be used. They have different merits and weaknesses. MMA and GCMMA tend to be braver in the beginning, proceeding quickly toward an approximate optimum, while IPOPT is more cautious but also converge more efficiently close to the final solution thanks to their second-order approximation of the objective.

Finally, it is worth noting that the problem of finding a stiff design can be quite different from finding a design that does not break, and it is generally advised to use shape or parameter optimization to ensure that the design is free from excessive stress concentrations.

## References

---

1. B.S. Lazarov and O. Sigmund, “Filters in topology optimization based on Helmholtz-type differential equations,” *Int. J. Numer. Methods Eng.*, vol. 86, pp. 765–781, 2011.
2. F. Wang, B.S. Lazarov, and O. Sigmund, “On projection methods, convergence and robust formulations in topology optimization,” *Struct. Multidiscipl. Optim.*, vol. 43, pp. 767–784, 2011.
3. M.P. Bendsøe, “Optimal shape design as a material distribution problem,” *Structural Optimization*, vol. 1, pp. 193–202, 1989.
4. L. Høghøj and E.A. Träff, “An advection–diffusion based filter for machinable designs in topology optimization,” *Comp. Meth. App. Mech. & Eng.*, vol. 391, pp. 114488, 2022.

---

**Application Library path:** Optimization\_Module/Topology\_Optimization/  
hook\_optimization\_stl

---

## Modeling Instructions



---

From the **File** menu, choose **New**.

### NEW



In the **New** window, click  **Model Wizard**.

## MODEL WIZARD

- 1 In the **Model Wizard** window, click  **3D**.
- 2 In the **Select Physics** tree, select **Structural Mechanics > Solid Mechanics (solid)**.
- 3 Click **Add**.
- 4 Click  **Study**.
- 5 In the **Select Study** tree, select **Preset Studies for Selected Physics Interfaces > Optimization > Topology Optimization, Stationary**.
- 6 Click  **Done**.

## GEOMETRY I

Create the geometry. To simplify this step, insert a prepared geometry sequence.

- 1 In the **Geometry** toolbar, click **Insert Sequence** and choose **Insert Sequence**.
- 2 Browse to the model's Application Libraries folder and double-click the file `hook_optimization_stl_geom_sequence.mph`.
- 3 In the **Geometry** toolbar, click  **Build All**.
- 4 Click the  **Zoom Extents** button in the **Graphics** toolbar.

5 In the **Model Builder** window, under **Component 1 (comp1)** click **Geometry 1**.

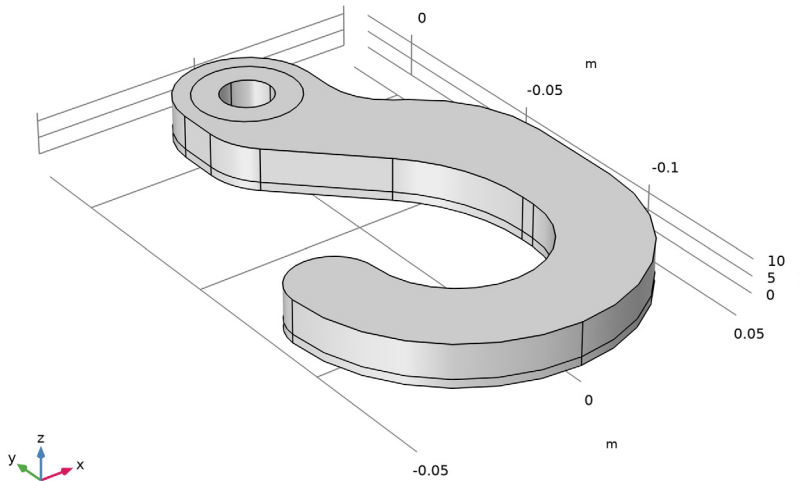

The geometry should now look like that in [Figure 1](#). Note that the inserted geometry is parameterized and that the parameters used are automatically added to the list of global parameters in the model.

## GLOBAL DEFINITIONS

### *Geometric Parameters*

- 1 In the **Model Builder** window, under **Global Definitions** click **Parameters 1**.
- 2 In the **Settings** window for **Parameters**, type Geometric Parameters in the **Label** text field.

Now there is a group for geometric parameters. Add a second group for parameters related to the optimization.

### *Parameters 2*

- 1 In the **Home** toolbar, click **Pi Parameters** and choose **Add > Parameters**.
- 2 In the **Settings** window for **Parameters**, locate the **Parameters** section.

3 In the table, enter the following settings:

Name	Expression	Value	Description
volfrac	0.5	0.5	Volume fraction
Lmin	2[mm]	0.002 m	Filter radius
meshsz	Lmin	0.002 m	Mesh size
meshsz2	Lmin/2	0.001 m	Fine mesh size

## MESH 1

### *Swept 1*



- 1 In the **Mesh** toolbar, click  **Swept**.
- 2 In the **Settings** window for **Swept**, locate the **Mesh Generation** section.
- 3 From the **Elements** list, choose **Prisms**.

### *Size*

- 1 In the **Model Builder** window, click **Size**.
- 2 In the **Settings** window for **Size**, locate the **Element Size** section.
- 3 Click the **Custom** button.
- 4 Locate the **Element Size Parameters** section. In the **Maximum element size** text field, type meshsz.
- 5 In the **Minimum element size** text field, type meshsz/4.
- 6 Click  **Build All**.

Use structural steel for the solid material.

## ADD MATERIAL

- 1 In the **Materials** toolbar, click  **Add Material** to open the **Add Material** window.
- 2 Go to the **Add Material** window.
- 3 In the tree, select **Built-in > Structural steel**.
- 4 Click the **Add to Global Materials** button in the window toolbar.
- 5 In the **Materials** toolbar, click  **Add Material** to close the **Add Material** window.

## MATERIALS

### *Topology Link 1 (toplnk1)*

- 1 In the **Model Builder** window, under **Component 1 (comp1) > Materials** click **Topology Link 1 (toplnk1)**.

- 2 In the **Settings** window for **Topology Link**, locate the **Link Settings** section.
- 3 From the **Material** list, choose **Structural steel (mat1)**.

The Young's modulus is now coupled to the material. Next, set up a mirror dataset for seeing the full design, while optimizing.

## TOPOLOGY OPTIMIZATION

### *Density Model 1 (dtopo1)*

- 1 In the **Model Builder** window, under **Component 1 (comp1) > Topology Optimization** click **Density Model 1 (dtopo1)**.
- 2 In the **Settings** window for **Density Model**, locate the **Geometric Entity Selection** section.
- 3 From the **Selection** list, choose **Optimized Domains**.
- 4 Locate the **Filtering** section. From the  $R_{\min}$  list, choose **User defined**.
- 5 In the text field, type  $L_{\min}$ .
- 6 Click to expand the **Manufacturing Constraints** section. From the **Manufacturing constraints** list, choose **Milling**.
- 7 In the table, enter the following settings:

<b>X</b>	<b>Y</b>	<b>Z</b>
0	0	-1

- 8 From the  $L_{\text{diff}}$  list, choose **User defined**.
- 9 In the text field, type 0.
- 10 Locate the **Projection** section. From the **Projection type** list, choose **Hyperbolic tangent projection**.
- 11 Locate the **Control Variable Discretization** section. From the **Element order** list, choose **Constant**.
- 12 Locate the **Control Variable Initial Value** section. In the  $\theta_0$  text field, type 0.1.

## COMPONENT 1 (COMP1)

### *Prescribed Material 1*

- 1 In the **Topology Optimization** toolbar, click  **Prescribed Material**.
- 2 In the **Settings** window for **Prescribed Material**, locate the **Geometric Entity Selection** section.
- 3 From the **Selection** list, choose **Fixed Domain**.

Add a **Material Boundary Density** and **Void Boundary Density** feature to avoid 90 degree angles at domain boundaries. In this case, these features will also cause the optimization to find design without internal cavities.

#### *Prescribed Material Boundary |*

- 1 In the **Topology Optimization** toolbar, click  **Prescribed Material Boundary**.
- 2 In the **Settings** window for **Prescribed Material Boundary**, locate the **Geometric Entity Selection** section.
- 3 From the **Selection** list, choose **Load Boundaries**.

#### *Prescribed Void Boundary |*

- 1 In the **Topology Optimization** toolbar, click  **Prescribed Void Boundary**.
- 2 In the **Settings** window for **Prescribed Void Boundary**, locate the **Geometric Entity Selection** section.
- 3 From the **Selection** list, choose **Free Boundaries**.

## **DEFINITIONS**

#### *Variables |*

In the **Model Builder** window, under **Component 1 (comp1)** right-click **Definitions** and choose **Variables**.

In topology optimization the geometry is not sufficiently well defined to warrant 2nd order shape functions.

## **SOLID MECHANICS (SOLID)**

In the **Settings** window for **Solid Mechanics**, click to expand the **Discretization** section.

#### *Fixed Constraint |*

- 1 In the **Physics** toolbar, click  **Boundaries** and choose **Fixed Constraint**.
- 2 In the **Settings** window for **Fixed Constraint**, locate the **Boundary Selection** section.
- 3 From the **Selection** list, choose **Hole**.

#### *Roller |*

- 1 In the **Physics** toolbar, click  **Boundaries** and choose **Roller**.
- 2 In the **Settings** window for **Roller**, locate the **Boundary Selection** section.
- 3 From the **Selection** list, choose **Symmetry**.
- 4 Click to expand the **Roller Constraint** section. From the **Normal orientation** list, choose **Plane**.

- 5 From the **Orientation of normal** list, choose **3**.

This avoids problems for the verification study, if there are numerical inaccuracies in the normal vector orientation.

Take both loads into account using the load case functionality.

#### *Boundary Load 1*

- 1 In the **Physics** toolbar, click  **Boundaries** and choose **Boundary Load**.
- 2 In the **Settings** window for **Boundary Load**, locate the **Boundary Selection** section.
- 3 From the **Selection** list, choose **1st Load Boundary**.
- 4 Locate the **Force** section. From the **Load type** list, choose **Total force**.
- 5 Specify the  $\mathbf{F}_{\text{tot}}$  vector as

0	x
-100 [kN]	y
0	z

- 6 In the **Physics** toolbar, click  **Load Group** and choose **New Load Group**.

#### *Boundary Load 2*

- 1 Right-click **Boundary Load 1** and choose **Duplicate**.
- 2 In the **Settings** window for **Boundary Load**, locate the **Boundary Selection** section.
- 3 From the **Selection** list, choose **2nd Load Boundary**.
- 4 In the **Physics** toolbar, click  **Load Group** and choose **New Load Group**.

### **STUDY 1: OPTIMIZATION**

- 1 In the **Model Builder** window, click **Study 1**.
- 2 In the **Settings** window for **Study**, type Study 1: Optimization in the **Label** text field.

#### *Step 1: Stationary*

- 1 In the **Model Builder** window, under **Study 1: Optimization** click **Step 1: Stationary**.
- 2 In the **Settings** window for **Stationary**, click to expand the **Study Extensions** section.
- 3 Select the **Define load cases** checkbox.
- 4 Click **+ Add**.
- 5 Click **+ Add**.

6 In the table, enter the following settings:

Load case	Ig1	Weight	Ig2	Weight
Load case 1	√	1.0		1.0
Load case 2		1.0	√	1.0

Initialize the study to generate plots to show while solving.

7 In the **Study** toolbar, click  **Get Initial Value**.

## RESULTS

### *Mirror 3D 1*

- 1 In the **Results** toolbar, click  **More Datasets** and choose **Mirror 3D**.
- 2 In the **Settings** window for **Mirror 3D**, locate the **Data** section.
- 3 From the **Dataset** list, choose **Filter**.
- 4 Locate the **Plane Data** section. From the **Plane** list, choose **xy-planes**.

### *Threshold*

- 1 In the **Model Builder** window, expand the **Results > Topology Optimization** node, then click **Threshold**.
- 2 In the **Settings** window for **3D Plot Group**, locate the **Data** section.
- 3 From the **Dataset** list, choose **Mirror 3D 1**.

## STUDY 1: OPTIMIZATION

### *Topology Optimization*

- 1 In the **Model Builder** window, under **Study 1: Optimization** click **Topology Optimization**.
- 2 In the **Settings** window for **Topology Optimization**, locate the **Optimization Solver** section.
- 3 In the **Maximum number of iterations** text field, type 25.

The control variable will not converge to the tolerance in so few iterations, but the actual design will not change noticeably by using more iterations.

4 Locate the **Constraints** section. In the table, enter the following settings:

Expression	Lower bound	Upper bound
comp1.dtopo1.theta_avg		volfrac

- 5 Click to expand the **Output** section. Select the **Plot** checkbox.
- 6 From the **Plot group** list, choose **Threshold**.

7 In the **Study** toolbar, click  **Compute**.

The optimization has removed material near the tip of the hook.

## RESULTS

*Output material volume factor*

1 In the **Model Builder** window, under **Results > Topology Optimization** click **Output material volume factor**.

2 In the **Output material volume factor** toolbar, click  **Plot**.

3 Click the  **Zoom Extents** button in the **Graphics** toolbar.

Add a finer mesh and solve for the filtered material volume factor on this.

## MESH 1

In the **Model Builder** window, under **Component 1 (comp1)** right-click **Mesh 1** and choose **Duplicate**.

## MESH 2

*Size*

1 In the **Model Builder** window, expand the **Mesh 2** node, then click **Size**.

2 In the **Settings** window for **Size**, locate the **Element Size Parameters** section.

3 In the **Maximum element size** text field, type meshsz2.

4 In the **Minimum element size** text field, type meshsz2/4.

5 Click  **Build All**.

## ADD STUDY

1 In the **Home** toolbar, click  **Add Study** to open the **Add Study** window.

2 Go to the **Add Study** window.

3 Find the **Studies** subsection. In the **Select Study** tree, select **General Studies > Stationary**.

4 Find the **Physics interfaces in study** subsection. In the table, clear the **Solve** checkbox for **Solid Mechanics (solid)**.

5 Click the **Add Study** button in the window toolbar.

6 In the **Home** toolbar, click  **Add Study** to close the **Add Study** window.

## STUDY 2: SMOOTH DESIGN (MESH2)

In the **Settings** window for **Study**, type Study 2: Smooth Design (mesh2) in the **Label** text field.

### *Solution 2 (sol2)*

In the **Study** toolbar, click  **Show Default Solver**.

### *Step 1: Stationary*

- 1 In the **Model Builder** window, expand the **Solution 2 (sol2)** node, then click **Study 2: Smooth Design (mesh2) > Step 1: Stationary**.
- 2 In the **Settings** window for **Stationary**, click to expand the **Values of Dependent Variables** section.
- 3 Find the **Initial values of variables solved for** subsection. From the **Settings** list, choose **User controlled**.
- 4 From the **Method** list, choose **Solution**.
- 5 From the **Study** list, choose **Study 1: Optimization, Stationary**.
- 6 In the **Study** toolbar, click  **Compute**.

## RESULTS

### *Filter 1*

Create a new component from the filter dataset.

- 1 In the **Model Builder** window, under **Results > Datasets** right-click **Filter 1** and choose **Create Mesh-Based Geometry**.

## MESH-BASED GEOMETRY 1

### *Remesh Faces 1*

- 1 In the **Mesh** toolbar, click  **More Generators** and choose **Remesh Faces**.
- 2 In the **Settings** window for **Remesh Faces**, locate the **Boundary Selection** section.
- 3 From the **Selection** list, choose **All boundaries**.

### *Size*

- 1 In the **Model Builder** window, expand the **Remesh Faces 1** node, then click **Size**.
- 2 In the **Settings** window for **Size**, locate the **Element Size** section.
- 3 From the **Predefined** list, choose **Finer**.
- 4 Click  **Build All**.

## MATERIALS

Use structural steel for the solid material.

### *Material Link 1 (matlnk1)*

In the **Model Builder** window, under **Component 2 (comp2)** right-click **Materials** and choose **More Materials > Material Link**.

## SOLID MECHANICS (SOLID)

Copy/paste the physics from the first component and fix the selections.

1 In the **Model Builder** window, under **Component 1 (comp1)** right-click **Solid Mechanics (solid)** and choose **Copy**.

## SOLID MECHANICS (SOLID2)

1 In the **Model Builder** window, right-click **Component 2 (comp2)** and choose **Paste Solid Mechanics**.

2 In the **Messages from Paste** dialog, click **OK**.

We can use 2nd order displacements now that we have an explicit geometry representation.

3 In the **Settings** window for **Solid Mechanics**, click to expand the **Discretization** section.

4 From the **Displacement field** list, choose **Quadratic serendipity**.

### *Fixed Constraint 1*

1 In the **Model Builder** window, expand the **Solid Mechanics (solid2)** node, then click **Fixed Constraint 1**.

2 In the **Settings** window for **Fixed Constraint**, locate the **Boundary Selection** section.

3 From the **Selection** list, choose **Hole**.

### *Roller 1*

1 In the **Model Builder** window, click **Roller 1**.

2 In the **Settings** window for **Roller**, locate the **Boundary Selection** section.

3 From the **Selection** list, choose **Symmetry**.

### *Boundary Load 1*

1 In the **Model Builder** window, click **Boundary Load 1**.

2 In the **Settings** window for **Boundary Load**, locate the **Boundary Selection** section.

3 From the **Selection** list, choose **1st Load Boundary**.

### *Boundary Load 2*

- 1 In the **Model Builder** window, click **Boundary Load 2**.
- 2 In the **Settings** window for **Boundary Load**, locate the **Boundary Selection** section.
- 3 From the **Selection** list, choose **2nd Load Boundary**.

### **COMPONENT 1: OPTIMIZATION**

- 1 In the **Model Builder** window, click **Component 1 (comp1)**.
- 2 In the **Settings** window for **Component**, type Component 1: Optimization in the **Label** text field.

### **COMPONENT 2: VERIFICATION**

- 1 In the **Model Builder** window, click **Component 2 (comp2)**.
- 2 In the **Settings** window for **Component**, type Component 2: Verification in the **Label** text field.

### **MESH 3**



#### *Free Tetrahedral 1*

In the **Mesh** toolbar, click  **Free Tetrahedral**.

#### *Size*

- 1 In the **Model Builder** window, click **Size**.
- 2 In the **Settings** window for **Size**, locate the **Element Size** section.
- 3 From the **Predefined** list, choose **Finer**.
- 4 Click  **Build All**.

### **ADD STUDY**

- 1 In the **Home** toolbar, click  **Add Study** to open the **Add Study** window.
- 2 Go to the **Add Study** window.
- 3 Find the **Studies** subsection. In the **Select Study** tree, select **General Studies > Stationary**.
- 4 Find the **Physics interfaces in study** subsection. In the table, clear the **Solve** checkbox for **Solid Mechanics (solid)**.
- 5 Click the **Add Study** button in the window toolbar.
- 6 In the **Home** toolbar, click  **Add Study** to close the **Add Study** window.

## STUDY 1: OPTIMIZATION

### Step 1: Stationary

- 1 In the **Settings** window for **Stationary**, locate the **Physics and Variables Selection** section.
- 2 In the **Solve for** column of the table, under **Component 2: Verification (comp2)**, clear the checkbox for **Solid Mechanics (solid2)**.

## STUDY 2: SMOOTH DESIGN (MESH2)

- 1 In the **Model Builder** window, under **Study 2: Smooth Design (mesh2)** click **Step 1: Stationary**.
- 2 In the **Settings** window for **Stationary**, locate the **Physics and Variables Selection** section.
- 3 In the **Solve for** column of the table, under **Component 2: Verification (comp2)**, clear the checkbox for **Solid Mechanics (solid2)**.

## STUDY 3: VERIFICATION

- 1 In the **Model Builder** window, under **Study 3** click **Step 1: Stationary**.
- 2 In the **Settings** window for **Stationary**, locate the **Physics and Variables Selection** section.
- 3 In the **Solve for** column of the table, under **Component 1: Optimization (comp1)**, clear the checkbox for **Topology Optimization**.
- 4 Click to expand the **Mesh Selection** section. In the table, enter the following settings:

Component	Mesh
Component 1	Mesh 1

- 5 Locate the **Study Extensions** section. Select the **Define load cases** checkbox.
- 6 Click **+ Add**.
- 7 Click **+ Add**.
- 8 In the table, enter the following settings:

Load case	lg1	Weight	lg2	Weight
Load case 1	√	1.0		1.0
Load case 2		1.0	√	1.0

- 9 In the **Model Builder** window, click **Study 3**.
- 10 In the **Settings** window for **Study**, type Study 3: Verification in the **Label** text field.
- 11 Locate the **Study Settings** section. Clear the **Generate default plots** checkbox.
- 12 In the **Study** toolbar, click **= Compute**.

Add a new 3D plot group to plot the displacement.

## RESULTS



### *Displacement (solid2)*

- 1 In the **Results** toolbar, click  **3D Plot Group**.
- 2 In the **Settings** window for **3D Plot Group**, type **Displacement (solid2)** in the **Label** text field.
- 3 Locate the **Data** section. From the **Dataset** list, choose **Study 3: Verification/ Solution 3 (4) (sol3)**.

### *Volume I*

Right-click **Displacement (solid2)** and choose **Volume**.

### *Displacement (solid2)*

- 1 Click the  **Zoom Extents** button in the **Graphics** toolbar.
- 2 In the **Displacement (solid2)** toolbar, click  **Plot**.

### *Topology Optimization I*

In the **Model Builder** window, under **Results** right-click **Topology Optimization I** and choose **Delete**.

## *Geometry Modeling Instructions*

---

If you want to create the geometry yourself, follow these steps.

## GLOBAL DEFINITIONS

### *Parameters I*

- 1 In the **Model Builder** window, under **Global Definitions** click **Parameters I**.
- 2 In the **Settings** window for **Parameters**, locate the **Parameters** section.
- 3 In the table, enter the following settings:

Name	Expression	Value	Description
r1	7.5[mm]	0.0075 m	Hole radius
r2	20[mm]	0.02 m	Max upper radius
r3	50[mm]	0.05 m	Max lower radius
r4	25[mm]	0.025 m	Min lower radius
Lc	90[mm]	0.09 m	Hole to hook center distance

Name	Expression	Value	Description
w1	2.5[mm]	0.0025 m	Width of load surface
w2	12.5[mm]	0.0125 m	Total width

### ADD COMPONENT

In the **Home** toolbar, click  **Add Component** and choose **3D**.

### GEOMETRY I

*Work Plane 1 (wp1)*

In the **Geometry** toolbar, click  **Work Plane**.

*Work Plane 1 (wp1) > Square 1 (sq1)*

- 1 In the **Work Plane** toolbar, click  **Square**.
- 2 In the **Settings** window for **Square**, locate the **Size** section.
- 3 In the **Side length** text field, type  $2*r1$ .
- 4 Locate the **Position** section. From the **Base** list, choose **Center**.

*Work Plane 1 (wp1) > Square 2 (sq2)*

- 1 In the **Work Plane** toolbar, click  **Square**.
- 2 In the **Settings** window for **Square**, locate the **Size** section.
- 3 In the **Side length** text field, type  $2*r2$ .
- 4 Locate the **Position** section. From the **Base** list, choose **Center**.

*Work Plane 1 (wp1) > Square 3 (sq3)*

- 1 In the **Work Plane** toolbar, click  **Square**.
- 2 In the **Settings** window for **Square**, locate the **Size** section.
- 3 In the **Side length** text field, type  $2*r3$ .
- 4 Locate the **Position** section. In the **xw** text field, type  $-r3$ .
- 5 In the **yw** text field, type  $-r3-Lc$ .



*Work Plane 1 (wp1) > Square 4 (sq4)*

- 1 In the **Work Plane** toolbar, click  **Square**.
- 2 In the **Settings** window for **Square**, locate the **Size** section.
- 3 In the **Side length** text field, type  $2*r4$ .
- 4 Locate the **Position** section. In the **xw** text field, type  $-r4$ .
- 5 In the **yw** text field, type  $-r4-Lc$ .



*Work Plane 1 (wp1) > Rectangle 1 (r1)*

- 1 In the **Work Plane** toolbar, click  **Rectangle**.
- 2 In the **Settings** window for **Rectangle**, locate the **Size and Shape** section.
- 3 In the **Width** text field, type  $r3-r4$ .
- 4 In the **Height** text field, type  $r3$ .
- 5 Locate the **Position** section. In the **xw** text field, type  $-r3$ .
- 6 In the **yw** text field, type  $-Lc+(r3-r4)/2$ .

*Work Plane 1 (wp1) > Difference 1 (dif1)*

- 1 In the **Work Plane** toolbar, click  **Booleans and Partitions** and choose **Difference**.
- 2 Click the  **Zoom Extents** button in the **Graphics** toolbar.
- 3 Select the objects **sq2** and **sq3** only.
- 4 In the **Model Builder** window, click **Difference 1 (dif1)**.
- 5 In the **Settings** window for **Difference**, locate the **Difference** section.
- 6 Click to select the  **Activate Selection** toggle button for **Objects to subtract**.
- 7 Select the objects **r1**, **sq1**, and **sq4** only.

*Work Plane 1 (wp1) > Partition Domains 1 (pard1)*

- 1 In the **Work Plane** toolbar, click  **Booleans and Partitions** and choose **Partition Domains**.
- 2 On the object **dif1**, select Domain 1 only.
- 3 In the **Settings** window for **Partition Domains**, locate the **Partition Domains** section.
- 4 Click to select the  **Activate Selection** toggle button for **Vertices defining line segments**.
- 5 On the object **dif1**, select Points 16 and 18 only.

*Work Plane 1 (wp1) > Delete Entities 1 (del1)*

- 1 In the **Model Builder** window, right-click **Plane Geometry** and choose **Delete Entities**.
- 2 In the **Settings** window for **Delete Entities**, locate the **Entities or Objects to Delete** section.
- 3 From the **Geometric entity level** list, choose **Domain**.
- 4 On the object **pard1**, select Domain 2 only.

*Work Plane 1 (wp1) > Fillet 1 (fil1)*

- 1 In the **Work Plane** toolbar, click  **Fillet**.
- 2 On the object **del1**, select Points 7–10 only.

- 3 In the **Settings** window for **Fillet**, locate the **Radius** section.
- 4 In the **Radius** text field, type r1.

*Work Plane 1 (wp1) > Fillet 2 (fil2)*

- 1 In the **Work Plane** toolbar, click  **Fillet**.
- 2 On the object **fil1**, select Points 2 and 4 only.
- 3 In the **Settings** window for **Fillet**, locate the **Radius** section.
- 4 In the **Radius** text field, type  $(r3 - r4) / 2$ .

*Work Plane 1 (wp1) > Fillet 3 (fil3)*

- 1 In the **Work Plane** toolbar, click  **Fillet**.
- 2 On the object **fil2**, select Points 4 and 14 only.
- 3 In the **Settings** window for **Fillet**, locate the **Radius** section.
- 4 In the **Radius** text field, type r4.



*Work Plane 1 (wp1) > Fillet 4 (fil4)*

- 1 In the **Work Plane** toolbar, click  **Fillet**.
- 2 On the object **fil3**, select Points 6 and 13 only.
- 3 In the **Settings** window for **Fillet**, locate the **Radius** section.
- 4 In the **Radius** text field, type r2.

*Work Plane 1 (wp1) > Fillet 5 (fil5)*

- 1 In the **Work Plane** toolbar, click  **Fillet**.
- 2 On the object **fil4**, select Points 1 and 17 only.
- 3 In the **Settings** window for **Fillet**, locate the **Radius** section.
- 4 In the **Radius** text field, type r3.

*Work Plane 1 (wp1) > Line Segment 1 (ls1)*

- 1 In the **Work Plane** toolbar, click  **More Primitives** and choose **Line Segment**.
- 2 On the object **fil5**, select Point 4 only.
- 3 In the **Settings** window for **Line Segment**, locate the **Endpoint** section.
- 4 Click to select the  **Activate Selection** toggle button for **End vertex**.
- 5 On the object **fil5**, select Point 16 only.

*Work Plane 1 (wp1) > Line Segment 2 (ls2)*

- 1 In the **Work Plane** toolbar, click  **More Primitives** and choose **Line Segment**.
- 2 On the object **fil5**, select Point 13 only.

- 3 In the **Settings** window for **Line Segment**, locate the **Endpoint** section.
- 4 Click to select the  **Activate Selection** toggle button for **End vertex**.
- 5 On the object **fil5**, select Point 18 only.

*Work Plane 1 (wp1) > Convert to Solid 1 (csol1)*

- 1 In the **Work Plane** toolbar, click  **Conversions** and choose **Convert to Solid**.
- 2 Click in the **Graphics** window and then press Ctrl+A to select all objects.

*Work Plane 1 (wp1) > Delete Entities 2 (del2)*

- 1 Right-click **Plane Geometry** and choose **Delete Entities**.
- 2 In the **Settings** window for **Delete Entities**, locate the **Entities or Objects to Delete** section.
- 3 From the **Geometric entity level** list, choose **Domain**.
- 4 On the object **csol1**, select Domain 4 only.

*Work Plane 1 (wp1) > Delete Entities 3 (del3)*

- 1 Right-click **Plane Geometry** and choose **Delete Entities**.
- 2 On the object **del2**, select Boundaries 2 and 7 only.

*Work Plane 1 (wp1) > Fillet 6 (fil6)*

- 1 In the **Work Plane** toolbar, click  **Fillet**.
- 2 On the object **del3**, select Points 4 and 13 only.
- 3 In the **Settings** window for **Fillet**, locate the **Radius** section.
- 4 In the **Radius** text field, type r2.

*Work Plane 1 (wp1) > Fillet 7 (fil7)*

- 1 In the **Work Plane** toolbar, click  **Fillet**.
- 2 On the object **fil6**, select Point 17 only.
- 3 In the **Settings** window for **Fillet**, locate the **Radius** section.
- 4 In the **Radius** text field, type r3.

*Work Plane 1 (wp1) > Fillet 8 (fil8)*

- 1 In the **Work Plane** toolbar, click  **Fillet**.
- 2 On the object **fil7**, select Point 21 only.
- 3 In the **Settings** window for **Fillet**, locate the **Radius** section.
- 4 In the **Radius** text field, type r4+2\*r1.

### *Extrude 1 (ext1)*

- 1 In the **Model Builder** window, right-click **Geometry 1** and choose **Extrude**.
- 2 In the **Settings** window for **Extrude**, locate the **Distances** section.
- 3 In the table, enter the following settings:

<b>Distances (m)</b>
w1
w2

- 4 Locate the **Selections of Resulting Entities** section. Select the **Resulting objects selection** checkbox.

### *Cylinder 1 (cyl1)*

- 1 In the **Geometry** toolbar, click  **Cylinder**.
- 2 In the **Settings** window for **Cylinder**, locate the **Size and Shape** section.
- 3 In the **Radius** text field, type  $2*r1$ .
- 4 In the **Height** text field, type  $w2$ .
- 5 Locate the **Selections of Resulting Entities** section. Select the **Resulting objects selection** checkbox.

### *Hook and Fixed Domain*

- 1 In the **Geometry** toolbar, click  **Selections** and choose **Union Selection**.
- 2 In the **Settings** window for **Union Selection**, type **Hook** and **Fixed Domain** in the **Label** text field.
- 3 Locate the **Geometric Entity Level** section. From the **Level** list, choose **Object**.
- 4 Locate the **Input Entities** section. Click **+ Add**.
- 5 In the **Add** dialog, in the **Selections to add** list, choose **Extrude 1** and **Cylinder 1**.
- 6 Click **OK**.

### *Partition Objects 1 (par1)*

- 1 In the **Geometry** toolbar, click  **Booleans and Partitions** and choose **Partition Objects**.
- 2 In the **Settings** window for **Partition Objects**, locate the **Partition Objects** section.
- 3 From the **Objects to partition** list, choose **Extrude 1**.
- 4 From the **Tool objects** list, choose **Cylinder 1**.

### *Symmetry*

- 1 In the **Geometry** toolbar, click  **Selections** and choose **Box Selection**.

- 2 In the **Settings** window for **Box Selection**, type Symmetry in the **Label** text field.
- 3 Locate the **Geometric Entity Level** section. From the **Level** list, choose **Boundary**.
- 4 Locate the **Box Limits** section. In the **z maximum** text field, type  $1e3*eps$ .
- 5 Locate the **Output Entities** section. From the **Include entity if** list, choose **Entity inside box**.

#### *Internal Boundary to Delete*

- 1 In the **Geometry** toolbar, click  **Selections** and choose **Box Selection**.
- 2 In the **Settings** window for **Box Selection**, type Internal Boundary to Delete in the **Label** text field.
- 3 Locate the **Geometric Entity Level** section. From the **Level** list, choose **Boundary**.
- 4 Locate the **Box Limits** section. In the **z minimum** text field, type  $w1*0.99$ .
- 5 In the **z maximum** text field, type  $w1*1.01$ .
- 6 Locate the **Output Entities** section. From the **Include entity if** list, choose **Entity inside box**.

#### *Delete Entities I (delI)*

- 1 Right-click **Geometry I** and choose **Delete Entities**.
- 2 In the **Settings** window for **Delete Entities**, locate the **Entities or Objects to Delete** section.
- 3 From the **Selection** list, choose **Internal Boundary to Delete**.

#### *Hole*

- 1 In the **Geometry** toolbar, click  **Selections** and choose **Cylinder Selection**.
- 2 In the **Settings** window for **Cylinder Selection**, type Hole in the **Label** text field.
- 3 Locate the **Geometric Entity Level** section. From the **Level** list, choose **Boundary**.
- 4 Locate the **Size and Shape** section. In the **Outer radius** text field, type  $r1*1.005$ .
- 5 Locate the **Output Entities** section. From the **Include entity if** list, choose **Entity inside cylinder**.

## **DEFINITIONS**

#### *Cylinder Ia*

In the **Definitions** toolbar, click  **Cylinder**.

## GEOMETRY I

### *1st Load Boundary*

- 1 In the **Geometry** toolbar, click  **Selections** and choose **Cylinder Selection**.
- 2 In the **Settings** window for **Cylinder Selection**, type 1st Load Boundary in the **Label** text field.
- 3 Locate the **Geometric Entity Level** section. From the **Level** list, choose **Boundary**.
- 4 Locate the **Size and Shape** section. In the **Outer radius** text field, type  $r4 * 1.001$ .
- 5 In the **Top distance** text field, type  $w1 * 1.001$ .
- 6 Locate the **Position** section. In the **y** text field, type  $-Lc$ .
- 7 Locate the **Output Entities** section. From the **Include entity if** list, choose **Entity inside cylinder**.

### *2nd Load Boundary*

- 1 In the **Geometry** toolbar, click  **Selections** and choose **Cylinder Selection**.
- 2 In the **Settings** window for **Cylinder Selection**, type 2nd Load Boundary in the **Label** text field.
- 3 Locate the **Geometric Entity Level** section. From the **Level** list, choose **Boundary**.
- 4 Locate the **Size and Shape** section. In the **Outer radius** text field, type  $(r3 - r4) / 2 * 1.001$ .
- 5 In the **Top distance** text field, type  $w1 * 1.001$ .
- 6 In the **End angle** text field, type 90.
- 7 Locate the **Position** section. In the **x** text field, type  $-(r3 + r4) / 2$ .
- 8 In the **y** text field, type  $-Lc$ .
- 9 Locate the **Output Entities** section. From the **Include entity if** list, choose **Entity inside cylinder**.

### *Fixed Domain*

- 1 In the **Geometry** toolbar, click  **Selections** and choose **Cylinder Selection**.
- 2 In the **Settings** window for **Cylinder Selection**, type Fixed Domain in the **Label** text field.
- 3 Locate the **Size and Shape** section. In the **Outer radius** text field, type  $r1 * 1.001$ .

### *Adjacent Selection 1 (adjsel1)*

In the **Geometry** toolbar, click  **Selections** and choose **Adjacent Selection**.

### *Load Boundaries*



- 1 In the **Geometry** toolbar, click  **Selections** and choose **Union Selection**.

- 2 In the **Settings** window for **Union Selection**, type Load Boundaries in the **Label** text field.
- 3 Locate the **Geometric Entity Level** section. From the **Level** list, choose **Boundary**.
- 4 Locate the **Input Entities** section. Click **+ Add**.
- 5 In the **Add** dialog, in the **Selections to add** list, choose **1st Load Boundary** and **2nd Load Boundary**.
- 6 Click **OK**.

#### *Optimized Domains*

- 1 In the **Model Builder** window, click **Adjacent Selection I (adjsel1)**.
- 2 In the **Settings** window for **Adjacent Selection**, locate the **Output Entities** section.
- 3 From the **Geometric entity level** list, choose **Adjacent domains**.
- 4 In the **Label** text field, type Optimized Domains.
- 5 Locate the **Input Entities** section. Click **+ Add**.
- 6 In the **Add** dialog, select **Fixed Domain** in the **Input selections** list.
- 7 Click **OK**.

#### *Free Boundaries*

- 1 In the **Geometry** toolbar, click  **Selections** and choose **Complement Selection**.
- 2 In the **Settings** window for **Complement Selection**, type Free Boundaries in the **Label** text field.
- 3 Locate the **Geometric Entity Level** section. From the **Level** list, choose **Boundary**.
- 4 Locate the **Input Entities** section. Click **+ Add**.
- 5 In the **Add** dialog, in the **Selections to invert** list, choose **Symmetry** and **Load Boundaries**.
- 6 Click **OK**.
- 7 In the **Geometry** toolbar, click  **Build All**.  
The model geometry is now complete.