



Model created in COMSOL Multiphysics 6.4

Viscoplastic Creep in Solder Joints

Introduction

This example studies viscoplastic creep in solder joints under thermal loading using the Anand viscoplasticity model.

The Anand model is suitable for large, isotropic, viscoplastic deformations in combination with small elastic deformations. The following flow equation takes the stress dependence into account when evaluating strain rate

$$\dot{\epsilon}_{\text{vpe}} = A e^{-Q/RT} \left[\sinh \left(\xi \frac{\sigma}{s_a} \right) \right]^{\frac{1}{m}}$$

where $\dot{\epsilon}_{\text{vpe}}$ is the equivalent viscoplastic strain rate, A is the viscoplastic rate, Q is the activation energy, m is the strain rate sensitivity, ξ is the stress multiplier, R is the ideal gas constant, and T is the absolute temperature.

The internal variable s_a is called deformation resistance. A dimensionless counterpart can be defined as $s_f = s_a/s_{\text{sat}}$, which follows the evolution equation

$$\dot{s}_f = \frac{h_0}{s_{\text{sat}}} \left| 1 - \frac{s_f}{s_f^*} \right|^a \text{sign} \left(1 - \frac{s_f}{s_f^*} \right) \dot{\epsilon}_{\text{vpe}}$$

where

$$s_f^* = \left(\frac{\dot{\epsilon}_{\text{vpe}}}{A} e^{Q/RT} \right)^n$$

is the saturation value of s_f , h_0 is the hardening coefficient, a is the exponent for hardening sensitivity, s_{sat} is the coefficient for deformation resistance saturation, and n is the exponent for the deformation resistance sensitivity.

Model Definition

The model geometry is shown in Figure 1. It includes two electronic components (chips) mounted on a circuit board by means of several solder ball joints.

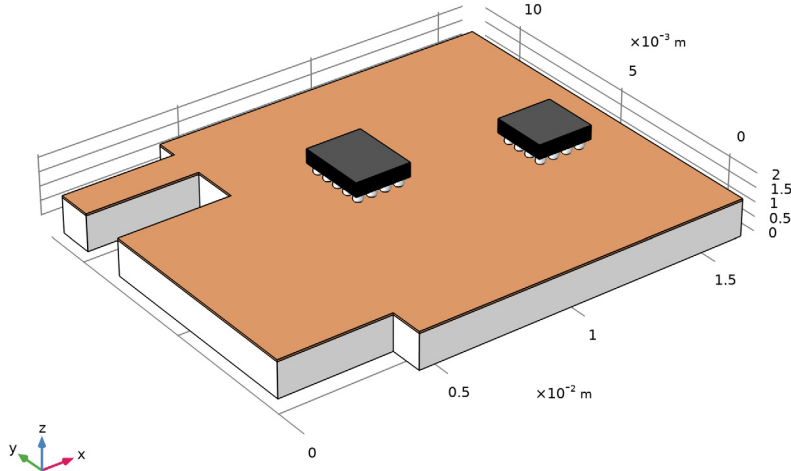

Figure 1: Model geometry.

The solder material is 60Sn40Pb. The circuit board consists of two layers: a thin layer of copper and a thicker layer of FR4 material. The chips are made of silicon. You can find the material and thermal properties for these three materials and for 60Sn40Pb in the material library available in COMSOL Multiphysics.

The nine material parameters needed to apply the Anand model for this solder are available in the literature (Ref. 1). They are summarized in the following table:

TABLE 1: MODEL DATA FOR THE VISCOPLASTIC SOLDER JOINTS MODEL.

PROPERTY	VALUE	DESCRIPTION
A	$1.49 \cdot 10^7$ 1/s	Viscoplastic rate
Q/R	10,830 K	Activation energy/ideal gas constant
m	0.303	Strain rate sensitivity of stress
n	0.0231	Sensitivity for deformation resistance
a	1.34	Strain rate sensitivity of hardening

TABLE 1: MODEL DATA FOR THE VISCOPLASTIC SOLDER JOINTS MODEL.

PROPERTY	VALUE	DESCRIPTION
s_{sat}	80.42 MPa	Coefficient for deformation resistance saturation
s_{init}	56.33 MPa	Initial value of deformation resistance
ξ	11	Stress multiplier
h_0	2640.75 MPa	Hardening coefficient

The structure has initially constant temperature $T_0 = 20$ °C. The heat generation within the chips causes the thermal loading of the structure. At first both components are switched on and operates during 4 h generating a power of $5 \cdot 10^7$ W/m³. Thereafter, both components are put on stand-by during 2 h, where the power decreases to $1 \cdot 10^7$ W/m³.

Results and Discussion

When you study the results, bear in mind that the mesh used here is too coarse to produce converged and reliable results for the stresses and strains. The model serves only to display the principal features.

The temperature distribution after 4 h of operation is shown in [Figure 2](#). The temperature is at its maximum and the increase is about 50°C compared to the initial temperature of the circuit board.

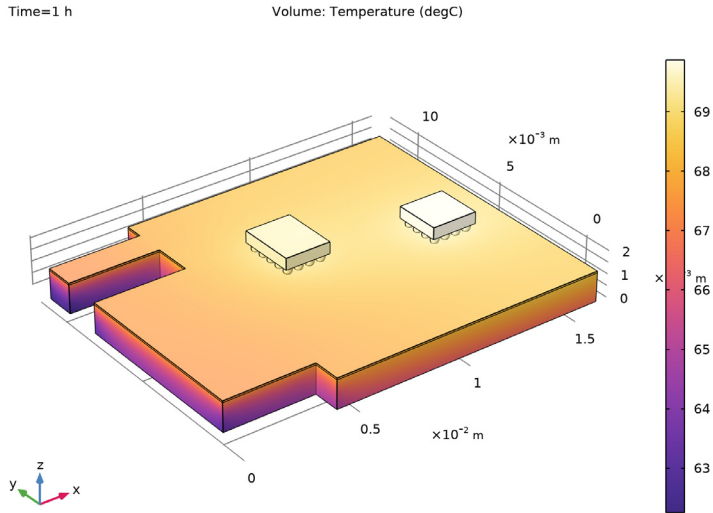

Figure 2: Final temperature distribution.

Figure 3 shows change in the deformation resistance through out the operating time.

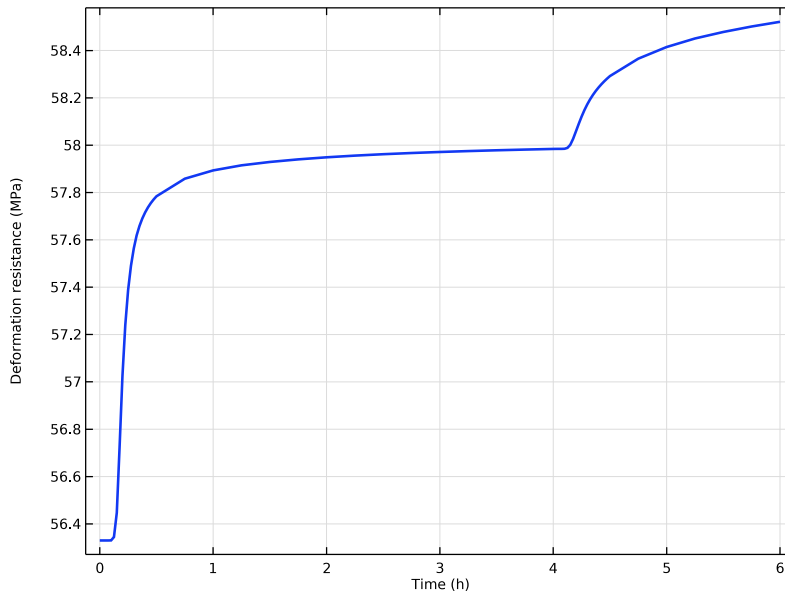

Figure 3: Evolution of the deformation resistance.

The development of elastic and inelastic strains at a point in a solder joint is shown in Figure 4. An intensive plastic flow appears after about 40 s of the loading, and inelastic strains dominates after about 5 min. The smooth transition at the beginning of the load history and after 4 h is partly affected by the time-dependent hardening behavior and partly affected by the smooth transition in the power load function, where a Heaviside step is replaced with a smooth ramping over a 0.1 h period.

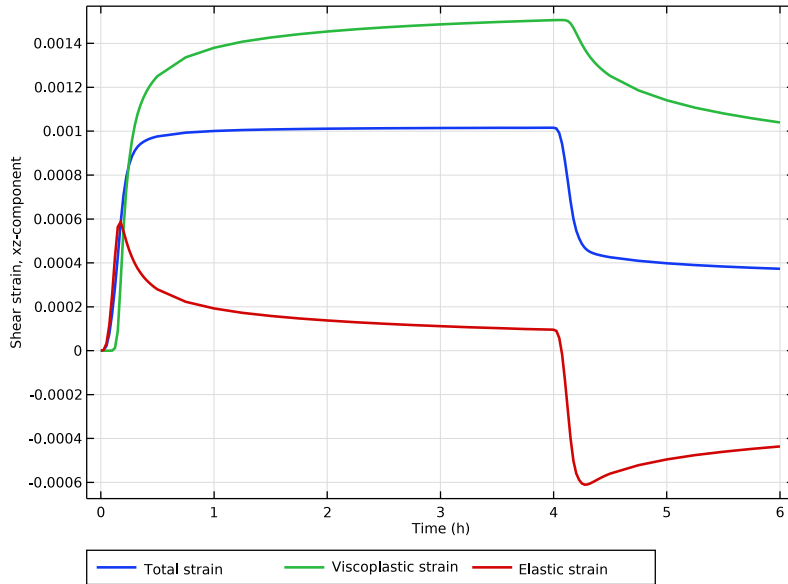

Figure 4: Shear strains in the most critical point.

In a model with creep or viscoplasticity, you can choose to compute also the dissipated energy, as is shown in this example. This quantity is used in several fatigue evaluation criteria when designing against thermal fatigue in electronic components. In [Figure 5](#) the dissipated energy as function of time is shown for the same point as the graphs above.

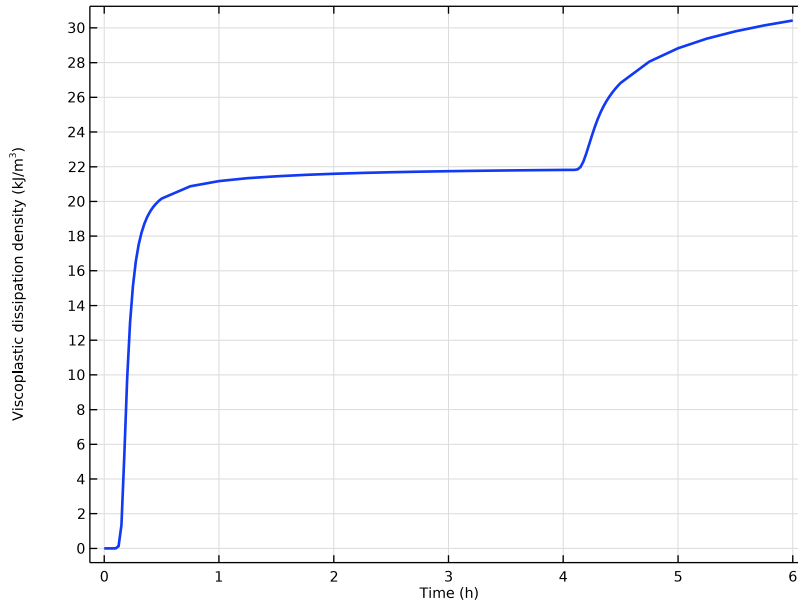

Figure 5: Viscoplastic dissipation density.

Notes About the COMSOL Implementation

In order to keep the model size down, the mesh is rather coarse (see [Figure 6](#)). The results in the solder balls are not accurate enough for making quantitative predictions. In reality, the best approach would probably be to first run a model of this type to find out which solder ball has the largest strains. In a second analysis, you can then analyze a model where an individual solder ball has an improved resolution.

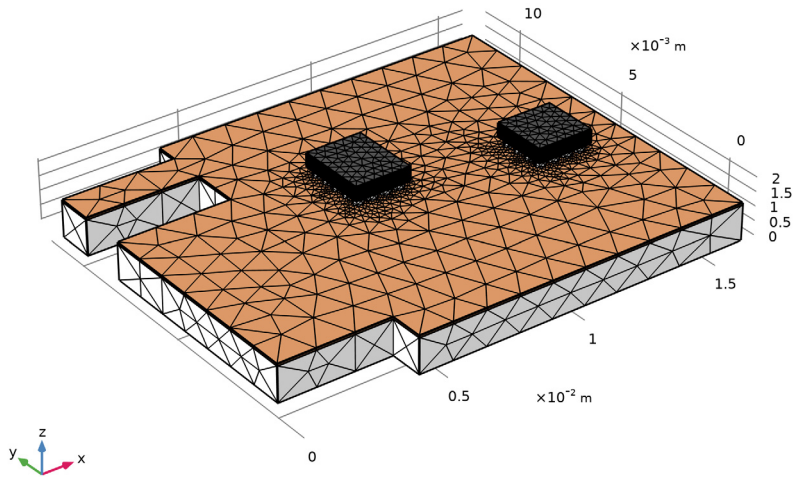

Figure 6: Meshed geometry.

Reference

1. Z.N. Cheng, G.Z. Wang, L. Chen, J. Wilde, and K. Becker, “Viscoplastic Anand Model for Solder Alloys and its Application,” *Soldering & Surface Mount Technology*, vol. 12, no. 2, pp. 31–36, 2000.

Application Library path: Nonlinear_Structural_Materials_Module/
Viscoplasticity/viscoplastic_solder_joints



Modeling Instructions

From the **File** menu, choose **New**.

NEW

In the **New** window, click  **Model Wizard**.

MODEL WIZARD

- 1 In the **Model Wizard** window, click  **3D**.
- 2 In the **Select Physics** tree, select **Structural Mechanics > Thermal–Structure Interaction > Thermal Stress, Solid**.
- 3 Click **Add**.
- 4 Click  **Study**.
- 5 In the **Select Study** tree, select **General Studies > Time Dependent**.
- 6 Click  **Done**.

GLOBAL DEFINITIONS

Parameters I

- 1 In the **Model Builder** window, under **Global Definitions** click **Parameters I**.
- 2 In the **Settings** window for **Parameters**, locate the **Parameters** section.
- 3 In the table, enter the following settings:

Name	Expression	Value	Description
T0	20[degC]	293.15 K	Initial temperature

Analytic I (anI)



- 1 In the **Home** toolbar, click  **Functions** and choose **Global > Analytic**.
- 2 In the **Settings** window for **Analytic**, type power in the **Function name** text field.
- 3 Locate the **Definition** section. In the **Expression** text field, type $(f1c2hs(x-0.1,0.1)*50) - f1c2hs(x-(4.1),0.1)*40$.
- 4 Locate the **Units** section. In the table, enter the following settings:

Argument	Unit
x	h

- 5 In the **Function** text field, type MW/m^3 .

GEOMETRY I

Import I (impI)

- 1 In the **Geometry** toolbar, click  **Import**.
- 2 In the **Settings** window for **Import**, locate the **Source** section.
- 3 Click  **Browse**.

4 Browse to the model's Application Libraries folder and double-click the file `viscoplastic_solder_joints.mphbin`.

5 Click  **null**.

Form Union (fin)

In the **Geometry** toolbar, click  **Build All**.

DEFINITIONS

FR4

1 In the **Definitions** toolbar, click  **Explicit**.

2 In the **Settings** window for **Explicit**, type FR4 in the **Label** text field.

3 Select Domain 1 only.

Copper

1 In the **Definitions** toolbar, click  **Explicit**.

2 In the **Settings** window for **Explicit**, type Copper in the **Label** text field.

3 Select Domain 2 only.

Silicon

1 In the **Definitions** toolbar, click  **Explicit**.

2 In the **Settings** window for **Explicit**, type Silicon in the **Label** text field.

3 Select Domains 3 and 24 only.

Solder

1 In the **Definitions** toolbar, click  **Explicit**.

2 In the **Settings** window for **Explicit**, type Solder in the **Label** text field.

3 Locate the **Input Entities** section. Select the **All domains** checkbox.

4 Select Domains 4–23 and 25–40 only.

You can do this by first copying the text '4-23 and 25-40' and then clicking the **Paste Selection** button next to the **Selection** box or clicking in the box and pressing **Ctrl+V**.

Solder_face

1 Right-click **Solder** and choose **Duplicate**.



2 In the **Settings** window for **Explicit**, type Solder_face in the **Label** text field.

3 Locate the **Output Entities** section. From the **Output entities** list, choose **Adjacent boundaries**.

Symmetry Boundaries

- 1 In the **Definitions** toolbar, click  **Explicit**.
- 2 In the **Settings** window for **Explicit**, type Symmetry Boundaries in the **Label** text field.
- 3 Locate the **Input Entities** section. From the **Geometric entity level** list, choose **Boundary**.
- 4 Select Boundaries 17, 19, 182, and 183 only.

Symmetry Complement

- 1 In the **Definitions** toolbar, click  **Complement**.
- 2 In the **Settings** window for **Complement**, type Symmetry Complement in the **Label** text field.
- 3 Locate the **Geometric Entity Level** section. From the **Level** list, choose **Boundary**.
- 4 Locate the **Input Entities** section. Under **Selections to invert**, click  **Add**.
- 5 In the **Add** dialog, select **Symmetry Boundaries** in the **Selections to invert** list.
- 6 Click **OK**.

MULTIPHYSICS

Thermal Expansion I (teI)

- 1 In the **Model Builder** window, under **Component 1 (comp1) > Multiphysics** click **Thermal Expansion I (teI)**.
- 2 In the **Settings** window for **Thermal Expansion**, locate the **Model Input** section.
- 3 Click  **Go to Source** for **Volume reference temperature**.

GLOBAL DEFINITIONS

Default Model Inputs



- 1 In the **Model Builder** window, under **Global Definitions** click **Default Model Inputs**.
- 2 In the **Settings** window for **Default Model Inputs**, locate the **Browse Model Inputs** section.
- 3 Find the **Expression for remaining selection** subsection. In the **Volume reference temperature** text field, type T0.

SOLID MECHANICS (SOLID)

Linear Elastic Material I

- In the **Model Builder** window, under **Component 1 (comp1) > Solid Mechanics (solid)** click **Linear Elastic Material I**.

Viscoplasticity I

- 1 In the **Physics** toolbar, click  **Attributes** and choose **Viscoplasticity**.
- 2 In the **Settings** window for **Viscoplasticity**, locate the **Domain Selection** section.
- 3 From the **Selection** list, choose **Solder**.
Add an equation for integrating the dissipated viscoplastic energy.
- 4 Click the  **Show More Options** button in the **Model Builder** toolbar.
- 5 In the **Show More Options** dialog, in the tree, select the checkbox for the node **Physics > Advanced Physics Options**.
- 6 Click **OK**.

Linear Elastic Material I

- 1 In the **Model Builder** window, click **Linear Elastic Material I**.
- 2 In the **Settings** window for **Linear Elastic Material**, click to expand the **Energy Dissipation** section.
- 3 From the **Store dissipation** list, choose **Individual contributions**.

Symmetry I

- 1 In the **Physics** toolbar, click  **Boundaries** and choose **Symmetry**.
- 2 In the **Settings** window for **Symmetry**, locate the **Boundary Selection** section.
- 3 From the **Selection** list, choose **Symmetry Boundaries**.

Prescribed Displacement I

- 1 In the **Physics** toolbar, click  **Points** and choose **Prescribed Displacement**.
- 2 Select Point 193 only.
- 3 In the **Settings** window for **Prescribed Displacement**, locate the **Prescribed Displacement** section.
- 4 From the **Displacement in z direction** list, choose **Prescribed**.

HEAT TRANSFER IN SOLIDS (HT)

Initial Values I

- 1 In the **Model Builder** window, under **Component 1 (comp1) > Heat Transfer in Solids (ht)** click **Initial Values I**.
- 2 In the **Settings** window for **Initial Values**, locate the **Initial Values** section.
- 3 In the T text field, type T0.

Symmetry 1

- 1 In the **Physics** toolbar, click  **Boundaries** and choose **Symmetry**.
- 2 In the **Settings** window for **Symmetry**, locate the **Boundary Selection** section.
- 3 From the **Selection** list, choose **Symmetry Boundaries**.



Heat Source 1

- 1 In the **Physics** toolbar, click  **Domains** and choose **Heat Source**.
- 2 In the **Settings** window for **Heat Source**, locate the **Domain Selection** section.
- 3 From the **Selection** list, choose **Silicon**.
- 4 Locate the **Heat Source** section. In the Q_0 text field, type power (t).

Heat Flux 1



- 1 In the **Physics** toolbar, click  **Boundaries** and choose **Heat Flux**.
Apply a heat flux on all exterior boundaries except those with prescribed symmetry.
- 2 In the **Settings** window for **Heat Flux**, locate the **Boundary Selection** section.
- 3 From the **Selection** list, choose **Symmetry Complement**.
- 4 Locate the **Heat Flux** section. From the **Flux type** list, choose **Convective heat flux**.
- 5 In the h text field, type 10.
- 6 In the T_{ext} text field, type T0.

ADD MATERIAL

- 1 In the **Materials** toolbar, click  **Add Material** to open the **Add Material** window.
- 2 Go to the **Add Material** window.
- 3 In the tree, select **Built-in > FR4 (Circuit Board)**.
- 4 Right-click and choose **Add to Global Materials**.
- 5 In the tree, select **Built-in > Copper**.
- 6 Right-click and choose **Add to Global Materials**.
- 7 In the tree, select **Built-in > Silicon**.
- 8 Right-click and choose **Add to Global Materials**.
- 9 In the tree, select **Built-in > Solder, 60Sn-40Pb**.
- 10 Right-click and choose **Add to Global Materials**.
- 11 In the **Materials** toolbar, click  **Add Material** to close the **Add Material** window.

MATERIALS

Material Link 1 (matLnk1)

- 1 In the **Model Builder** window, under **Component 1 (comp1)** right-click **Materials** and choose **More Materials > Material Link**.
- 2 In the **Settings** window for **Material Link**, locate the **Geometric Entity Selection** section.
- 3 From the **Selection** list, choose **FR4**.
- 4 Click to expand the **Appearance** section. From the **Material type** list, choose **PCB**.
- 5 In the **Graphics** window toolbar, click  next to  **Colors**, then choose **Show Material Color and Texture**.

Material Link 2 (matLnk2)

- 1 Right-click **Materials** and choose **More Materials > Material Link**.
- 2 In the **Settings** window for **Material Link**, locate the **Geometric Entity Selection** section.
- 3 From the **Selection** list, choose **Copper**.
- 4 Locate the **Link Settings** section. From the **Material** list, choose **Copper (mat2)**.
- 5 Click to expand the **Appearance** section. From the **Material type** list, choose **Copper**.

Material Link 3 (matLnk3)

- 1 Right-click **Materials** and choose **More Materials > Material Link**.
- 2 In the **Settings** window for **Material Link**, locate the **Geometric Entity Selection** section.
- 3 From the **Selection** list, choose **Silicon**.
- 4 Locate the **Link Settings** section. From the **Material** list, choose **Silicon (mat3)**.
- 5 Click to expand the **Appearance** section. From the **Color** list, choose **Black**.

Material Link 4 (matLnk4)

- 1 Right-click **Materials** and choose **More Materials > Material Link**.
- 2 In the **Settings** window for **Material Link**, locate the **Geometric Entity Selection** section.
- 3 From the **Selection** list, choose **Solder**.
- 4 Locate the **Link Settings** section. From the **Material** list, choose **Solder, 60Sn-40Pb (mat4)**.
- 5 Click to expand the **Appearance** section. From the **Material type** list, choose **Steel**.

MESH 1

- 1 In the **Model Builder** window, under **Component 1 (comp1)** click **Mesh 1**.
- 2 In the **Settings** window for **Mesh**, locate the **Physics-Controlled Mesh** section.
- 3 In the table, clear the **Use** checkbox for **Geometric Analysis, Detail Size**.

- 4 Locate the **Sequence Type** section. From the list, choose **User-controlled mesh**.

Free Tetrahedral I

- 1 In the **Model Builder** window, under **Component 1 (comp1) > Mesh 1** click **Free Tetrahedral 1**.
- 2 In the **Settings** window for **Free Tetrahedral**, locate the **Domain Selection** section.
- 3 From the **Geometric entity level** list, choose **Domain**.
- 4 From the **Selection** list, choose **Solder**.

Size

- 1 In the **Model Builder** window, click **Size**.
- 2 In the **Settings** window for **Size**, locate the **Element Size** section.
- 3 From the **Predefined** list, choose **Fine**.

Free Tetrahedral I

- 1 In the **Model Builder** window, right-click **Free Tetrahedral 1** and choose **Build All**.
- 2 Click the  **Wireframe Rendering** button in the **Graphics** toolbar to see the meshed domains.

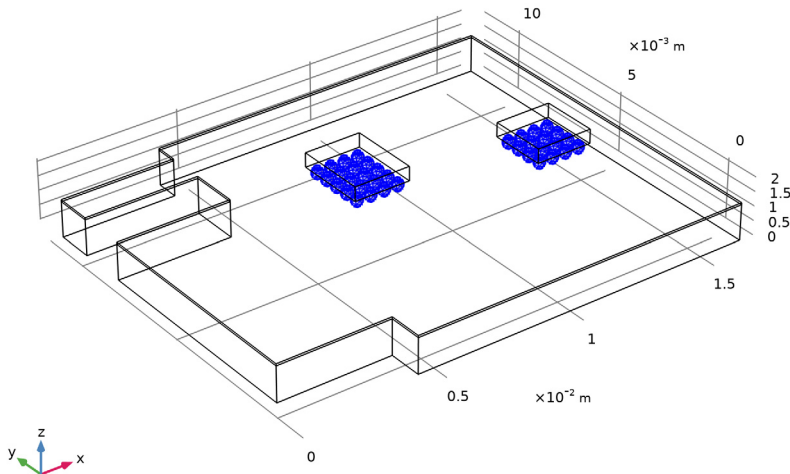

Free Triangular I

- 1 In the **Mesh** toolbar, click  **More Generators** and choose **Free Triangular**.

- 2 Select Boundary 7 only.
- 3 In the **Settings** window for **Free Triangular**, click  **Build All**.

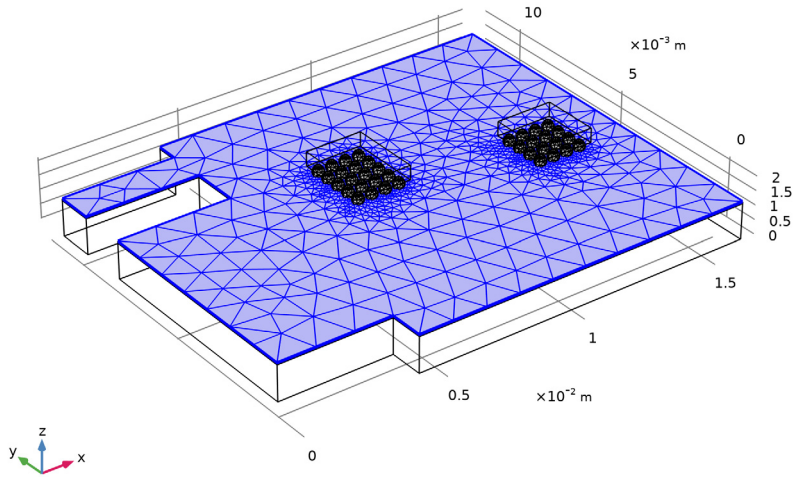

Swept 1

- 1 In the **Mesh** toolbar, click  **Swept**.
- 2 In the **Settings** window for **Swept**, locate the **Domain Selection** section.
- 3 From the **Geometric entity level** list, choose **Domain**.
- 4 From the **Selection** list, choose **Copper**.

5 Click  **Build All**.

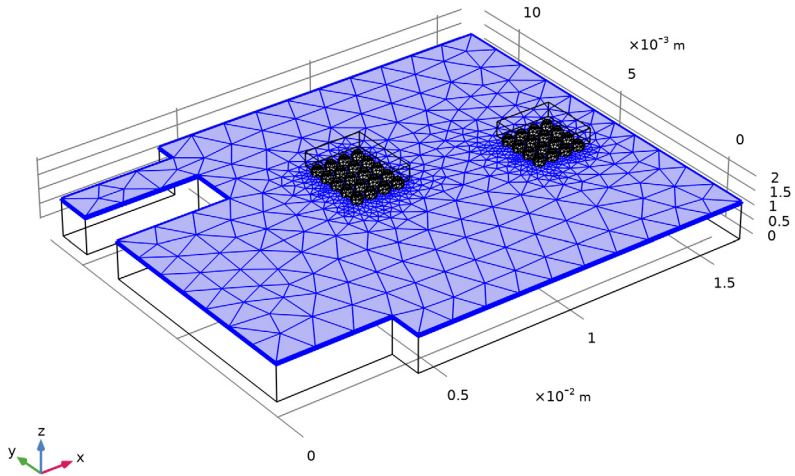

Free Tetrahedral 2

1 In the **Mesh** toolbar, click  **Free Tetrahedral**.

2 In the **Settings** window for **Free Tetrahedral**, click  **Build All**.

3 Click the  **Wireframe Rendering** button in the **Graphics** toolbar.

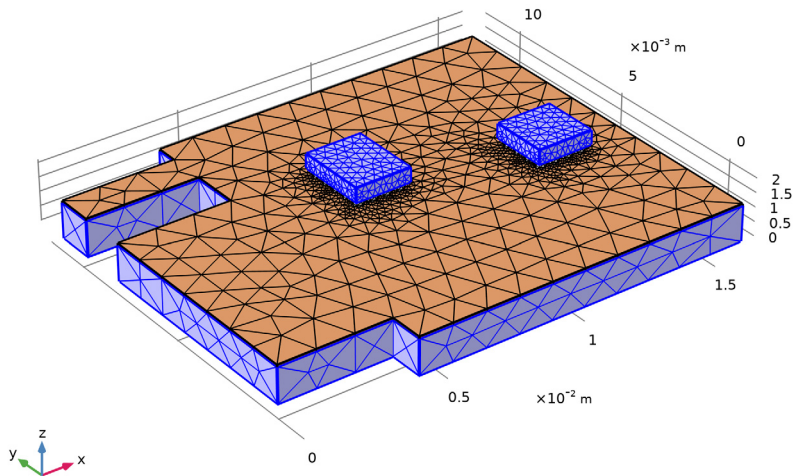

STUDY 1

Step 1: Time Dependent

The coupling only applies from Heat Transfer in Solids to Solid Mechanics. Solve Heat Transfer in Solids in a first time-dependent step and then Solid Mechanics in a second time-dependent step.

- 1 In the **Model Builder** window, under **Study 1** click **Step 1: Time Dependent**.
- 2 In the **Settings** window for **Time Dependent**, locate the **Study Settings** section.
- 3 From the **Time unit** list, choose **h**.
- 4 In the **Output times** text field, type `0 0.005 range(0.025,0.025,0.5) range(0.75,0.25,3.75) 3.975 4+{range(0,0.025,0.5) range(0.75,0.25,2)}`.
- 5 Locate the **Physics and Variables Selection** section. In the **Solve for** column of the table, under **Component 1 (comp1)**, clear the checkbox for **Solid Mechanics (solid)**.

Step 2: Time Dependent 2

- 1 In the **Study** toolbar, click  **Time Dependent**.
- 2 In the **Settings** window for **Time Dependent**, locate the **Study Settings** section.

- 3 From the **Time unit** list, choose **h**.
- 4 In the **Output times** text field, type $0\ 0.005\ \text{range}(0.025, 0.025, 0.5)\ \text{range}(0.75, 0.25, 3.75)\ 3.975\ 4\{\text{range}(0, 0.025, 0.5)\ \text{range}(0.75, 0.25, 2)\}$.
- 5 Locate the **Physics and Variables Selection** section. In the **Solve for** column of the table, under **Component 1 (comp1)**, clear the checkbox for **Heat Transfer in Solids (ht)**.
- 6 Click to expand the **Values of Dependent Variables** section. Find the **Values of variables not solved for** subsection. From the **Settings** list, choose **User controlled**.
- 7 From the **Method** list, choose **Solution**.
- 8 From the **Study** list, choose **Study 1, Time Dependent**.
- 9 From the **Selection** list, choose **Automatic (all solutions)**.

Solution 1 (sol1)

- 1 In the **Study** toolbar, click  **Show Default Solver**.
In cases where time derivatives are not important as results, the file size can be significantly reduced by not storing these variables.
- 2 In the **Model Builder** window, expand the **Solution 1 (sol1)** node, then click **Time-Dependent Solver 1**.
- 3 In the **Settings** window for **Time-Dependent Solver**, click to expand the **Output** section.
- 4 Clear the **Store the first time derivative** checkbox.
- 5 Click to expand the **Time Stepping** section. From the **Steps taken by solver** list, choose **Strict**.
- 6 In the **Model Builder** window, under **Study 1 > Solver Configurations > Solution 1 (sol1)** click **Time-Dependent Solver 2**.
- 7 In the **Settings** window for **Time-Dependent Solver**, locate the **Output** section.
- 8 Clear the **Store the first time derivative** checkbox.
- 9 Locate the **Time Stepping** section. From the **Steps taken by solver** list, choose **Strict**.
- 10 Find the **Algebraic variable settings** subsection. From the **Error estimation** list, choose **Exclude algebraic**.
- 11 In the **Model Builder** window, under **Study 1 > Solver Configurations > Solution 1 (sol1) > Time-Dependent Solver 2** click **Fully Coupled 1**.
- 12 In the **Settings** window for **Fully Coupled**, click to expand the **Method and Termination** section.
- 13 From the **Nonlinear method** list, choose **Constant (Newton)**.

- 14 In the **Maximum number of iterations** text field, type 20.
- 15 Click in the **Graphics** window and then press Ctrl+A to select all domains.
- 16 In the **Study** toolbar, click  **Compute**.

RESULTS

Temperature (ht)

- 1 In the **Model Builder** window, under **Results** click **Temperature (ht)**.
- 2 In the **Settings** window for **3D Plot Group**, locate the **Data** section.
- 3 From the **Time (h)** list, choose **1**.

Volume 1

- 1 In the **Model Builder** window, expand the **Temperature (ht)** node, then click **Volume 1**.
- 2 In the **Settings** window for **Volume**, locate the **Expression** section.
- 3 In the **Unit** field, type degC.
- 4 In the **Temperature (ht)** toolbar, click  **Plot**.

Display the deformation resistance history.

Deformation Resistance History

- 1 In the **Results** toolbar, click  **ID Plot Group**.
- 2 In the **Settings** window for **ID Plot Group**, type Deformation Resistance History in the **Label** text field.
- 3 Click to expand the **Title** section. From the **Title type** list, choose **None**.

Point Graph 1

- 1 Right-click **Deformation Resistance History** and choose **Point Graph**.
- 2 Select Point 36 only.
- 3 In the **Settings** window for **Point Graph**, locate the **y-Axis Data** section.
- 4 In the **Expression** text field, type solid.saGp.
- 5 From the **Unit** list, choose **MPa**.
- 6 Click to expand the **Coloring and Style** section. From the **Width** list, choose **2**.
- 7 In the **Deformation Resistance History** toolbar, click  **Plot**.

Display the strain history.

Strain History

- 1 In the **Results** toolbar, click  **ID Plot Group**.

2 In the **Settings** window for **ID Plot Group**, type Strain History in the **Label** text field.

Point Graph 1

- 1 Right-click **Strain History** and choose **Point Graph**.
- 2 Select Point 36 only.
- 3 In the **Settings** window for **Point Graph**, locate the **y-Axis Data** section.
- 4 In the **Expression** text field, type `solid.gpeval(solid.e113)`.
- 5 Locate the **Coloring and Style** section. From the **Width** list, choose **2**.
- 6 Click to expand the **Legends** section. Select the **Show legends** checkbox.
- 7 From the **Legends** list, choose **Manual**.
- 8 In the table, enter the following settings:

Legends
Total strain

Point Graph 2

- 1 Right-click **Point Graph 1** and choose **Duplicate**.
- 2 In the **Settings** window for **Point Graph**, locate the **y-Axis Data** section.
- 3 In the **Expression** text field, type `solid.gpeval(solid.evpl13)`.
- 4 Locate the **Legends** section. In the table, enter the following settings:

Legends
Viscoplastic strain

Point Graph 3

- 1 Right-click **Point Graph 2** and choose **Duplicate**.
- 2 In the **Settings** window for **Point Graph**, locate the **y-Axis Data** section.
- 3 In the **Expression** text field, type `solid.gpeval(solid.e113-solid.evpl13)`.
- 4 Locate the **Legends** section. In the table, enter the following settings:

Legends
Elastic strain

Strain History

- 1 In the **Model Builder** window, click **Strain History**.
- 2 In the **Settings** window for **ID Plot Group**, locate the **Plot Settings** section.

- 3 Select the **y-axis label** checkbox. In the associated text field, type Shear strain, xz-component.
- 4 Locate the **Title** section. From the **Title type** list, choose **None**.
- 5 Locate the **Legend** section. From the **Layout** list, choose **Outside graph axis area**.
- 6 From the **Position** list, choose **Bottom**.
- 7 In the **Strain History** toolbar, click  **Plot**.

Display the dissipation history.

Dissipation History

- 1 In the **Model Builder** window, right-click **Deformation Resistance History** and choose **Duplicate**.
- 2 In the **Settings** window for **ID Plot Group**, type Dissipation History in the **Label** text field.

Point Graph 1

- 1 In the **Model Builder** window, expand the **Dissipation History** node, then click **Point Graph 1**.
- 2 In the **Settings** window for **Point Graph**, click **Replace Expression** in the upper-right corner of the **y-Axis Data** section. From the menu, choose **Component 1 (comp1) > Solid Mechanics > Energy and power > solid.WvpGp - Viscoplastic dissipation density - J/m³**.
- 3 Locate the **y-Axis Data** section. From the **Unit** list, choose **kJ/m³**.

Dissipation History

- 1 In the **Model Builder** window, click **Dissipation History**.
- 2 In the **Dissipation History** toolbar, click  **Plot**.

Finally, display the temperature history.

Temperature History

- 1 Right-click **Dissipation History** and choose **Duplicate**.
- 2 In the **Settings** window for **ID Plot Group**, type Temperature History in the **Label** text field.

Point Graph 1

- 1 In the **Model Builder** window, expand the **Temperature History** node, then click **Point Graph 1**.

- 2 In the **Settings** window for **Point Graph**, click **Replace Expression** in the upper-right corner of the **y-Axis Data** section. From the menu, choose **Component 1 (comp1) > Heat Transfer in Solids > Temperature > T - Temperature - K**.
- 3 Locate the **y-Axis Data** section. In the **Unit** field, type degC.
- 4 In the **Temperature History** toolbar, click  **Plot**.