



Model created in COMSOL Multiphysics 6.4

Lemaitre–Chaboche Viscoplastic Model

Introduction

Most metals and alloys undergo viscoplastic deformation at high temperatures. In case of cyclic loading, a constitutive law with both isotropic and kinematic hardening is necessary to describe effects such as ratcheting, cyclic softening/hardening, and stress relaxation. The Lemaitre–Chaboche viscoplastic model combines isotropic hardening with nonlinear kinematic hardening to model these effects.

This tutorial model demonstrates the uniaxial deformation of an indium IN 100 test specimen submitted to cyclic tension-compression loading at high temperature, as described in [Ref. 1](#).

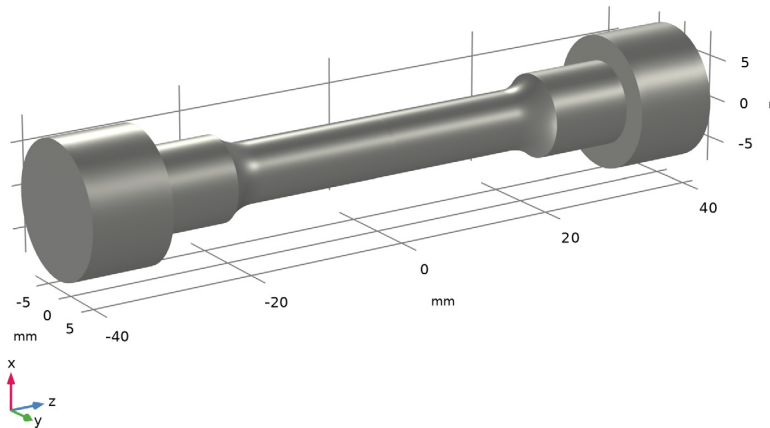

Figure 1: Specimen used for the uniaxial tension–compression tests.

Model Definition

The test specimen consists of a small cylinder with a thin central section to ensure uniform stress and strain distributions. Thick parts are added to the ends of the specimen to ease the mounting in a universal testing machine. To reduce the computation time, half of the specimen is modeled in a 2D axisymmetric geometry.

GOVERNING EQUATIONS

The strain tensor consists of the sum of the elastic strain tensor ε_{el} and the viscoelastic strain tensor ε_{vp} :

$$\varepsilon = \varepsilon_{el} + \varepsilon_{vp}$$

The constitutive law between stress and strain is given by Hooke's law

$$\sigma = \mathbf{C}:(\varepsilon - \varepsilon_{vp})$$

The viscoplastic strain tensor is defined by the Lemaitre–Chaboche viscoplastic flow rule

$$\dot{\varepsilon}_{vp} = \frac{3}{2} \dot{\varepsilon}_{vpe} \frac{\sigma' - \sigma_b'}{J_2(\sigma - \sigma_b)}$$

where σ_b is the back-stress tensor, derived by the nonlinear kinematic hardening rule; and σ' and σ_b' are the deviatoric parts of the stress and back-stress tensors σ and σ_b .

The equivalent viscoplastic strain rate is defined by the expression

$$\dot{\varepsilon}_{vpe} = \max\left(A \left(\frac{J_2(\sigma - \sigma_b) - \sigma_y}{\sigma_{ref}}\right)^n, 0\right)$$

where A is the viscoplastic rate coefficient, σ_{ref} is a reference stress, n is the stress exponent, and σ_y is the yield stress given by the nonlinear isotropic hardening rule.

MIXED HARDENING

The isotropic hardening model represents the change in yield stress as a function of the equivalent viscoplastic strain. Lemaitre and Chaboche (Ref. 1) derived a nonlinear isotropic hardening relation of the type

$$\sigma_y = \sigma_{ys0} + \sigma_{sat} \left(1 - e^{-\beta \varepsilon_{vpe}}\right)$$

where σ_{ys0} is the initial yield stress, and σ_{sat} and β are material parameters.

The kinematic hardening rule represents the translation of the yield surface as a function of the back-stress σ_b and the equivalent viscoplastic strain ε_{vp} . Lemaitre and Chaboche (Ref. 1) derived a nonlinear kinematic hardening relation where the back-stress tensor is calculated from the ordinary differential equation

$$\dot{\sigma}_b = \frac{2}{3} C_k \dot{\varepsilon}_{vp} - \gamma_k \dot{\varepsilon}_{vpe} \sigma_b$$

where C_k and γ_k are material parameters. The kinematic hardening parameter γ_k also depends exponentially on the equivalent viscoplastic strain:

$$\gamma_k = \gamma_s + (\gamma_0 - \gamma_s)e^{-\beta_k \epsilon_{vpe}}$$

where γ_s , γ_0 , and β_k are material parameters.

MATERIAL DATA

The material parameters of the indium alloy IN 100 at a temperature of 900 K are given in [Ref. 1](#).

TABLE 1: MATERIAL PARAMETERS, IN 100 AT 900 K.

Parameter	Value
K	490 MPa.s ^{1/n}
n	9
σ_{y0}	60 MPa
$\sigma_{y0} + \sigma_{sat}$	25 MPa
b	200
C_k	362,500 MPa
γ_0	1200
γ_s	1540
β_k	1000

In [Ref. 1](#), the parameter K is given in units of MPa.s^{1/n}. The parameters K , A , and σ_{ref} are related by the expression

$$\frac{A}{(\sigma_{ref})^n} = \frac{1}{K^n}$$

Use the values $A = 1/s$ and $\sigma_{ref} = 490$ MPa to obtain similar results as in given in [Ref. 1](#).

Results and Discussion

STRESS VS. TIME

After the first tensile cycle the axial stress (blue line in [Figure 2](#)) increases linearly, exceeding the yield strength (cyan line). Because of viscous effects, the onset of plasticity starts once the viscous stress (green line) reaches the yield strength. At this point, the

relation between stress and strain is no longer linear, kinematic/isotropic hardening evolves, and the back-stress (red line) increases.

When the maximum allowed tensile strain is reached, the prescribed axial velocity turns negative to prescribe axial unloading. The axial stress then decreases linearly, and the back stress remains constant to account for kinematic hardening and the Bauschinger effect. The yield strength in compression after a tensile cycle is lower than the initial yield strength.

In the compressive cycle, the viscoplastic flow starts earlier and lasts for a longer period. When the maximum allowed compressive strain is reached, the prescribed axial velocity becomes positive to prescribe tensile unloading. This procedure is repeated for each load cycle.

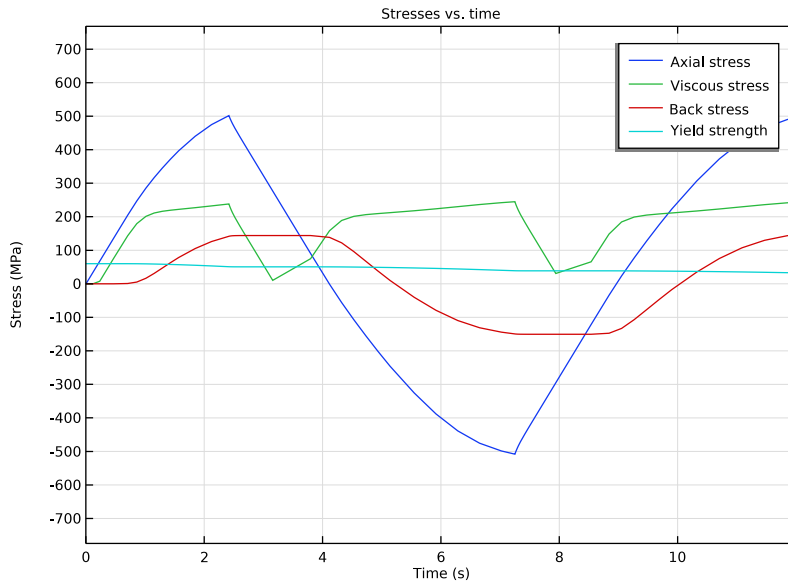

Figure 2: Evolution of the axial stress variables with time.

Four studies are performed to prescribe four different types of loading cycles: prescribed symmetric strain, prescribed symmetric stress, prescribed nonsymmetric strain, and prescribed nonsymmetric stress. The stress-strain graph for each type of loading cycle highlights material properties of the Lemaitre–Chaboche viscoplastic model.

SYMMETRIC CYCLES

Symmetric loading aims to show the stabilization effect of the hysteresis cycle. This emphasizes the softening or hardening effect during cyclic loadings for a given hardening rule.

For the symmetric prescribed axial strain cycle shown in [Figure 3](#), there is a periodic response to the periodic load and a stabilized state is reached after few cycles. A closer view shows that the stress amplitude decreases during the first cycles due to material softening.

A similar effect can be seen in the symmetric prescribed stress cycle in [Figure 4](#), but more cycles are needed to reach a stabilized state when compared to the prescribed strain loading. Lastly, the axial strain amplitude increases with the number of cycles. This is an effect of the isotropic hardening rule. With kinematic hardening only, the stabilized state is reached after the first cycle of prescribed stress. Thus, a mixed hardening formulation is needed to model both cyclic softening/hardening and Bauschinger effects.

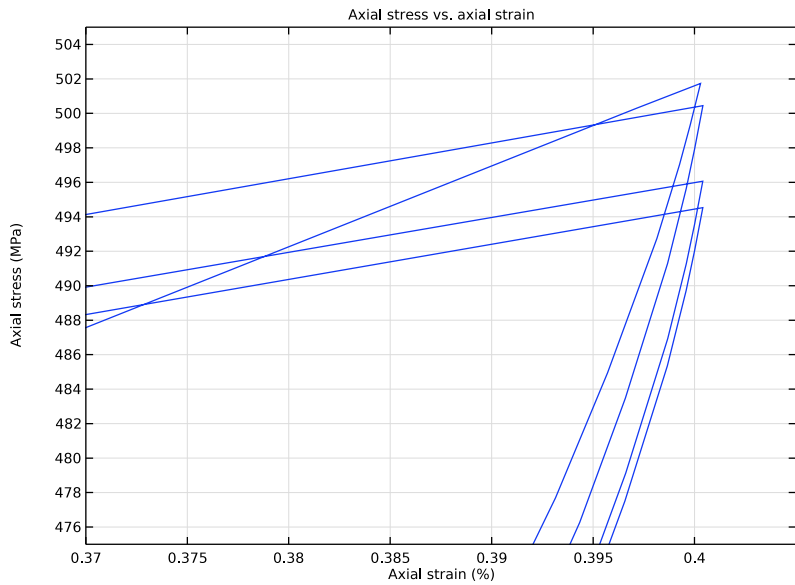
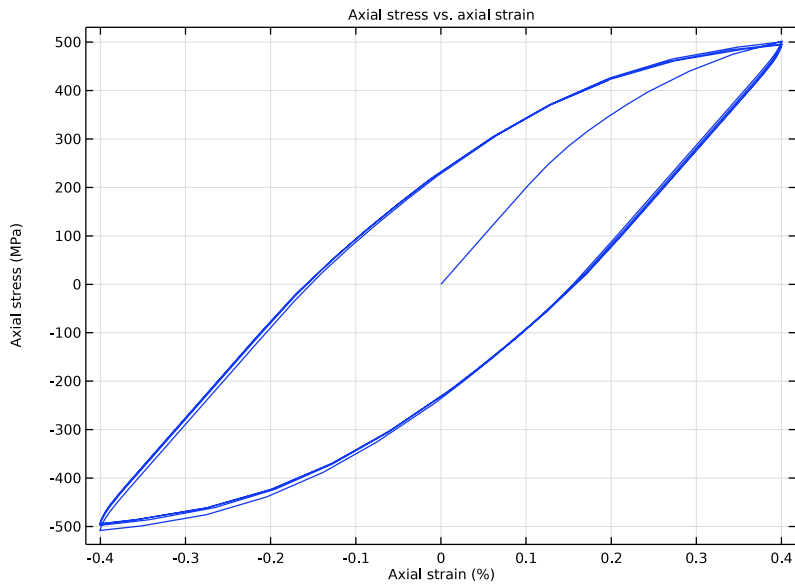

Figure 3: Axial stress versus axial strain for a symmetric prescribed strain loading.

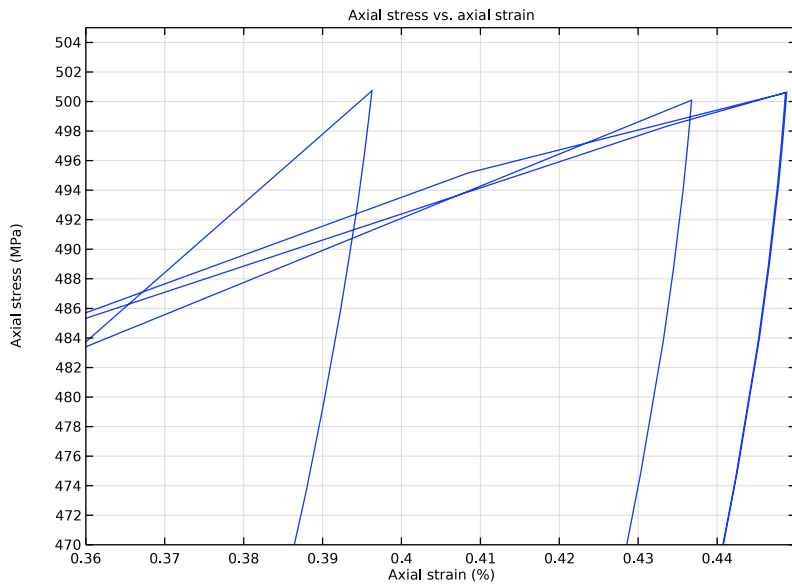
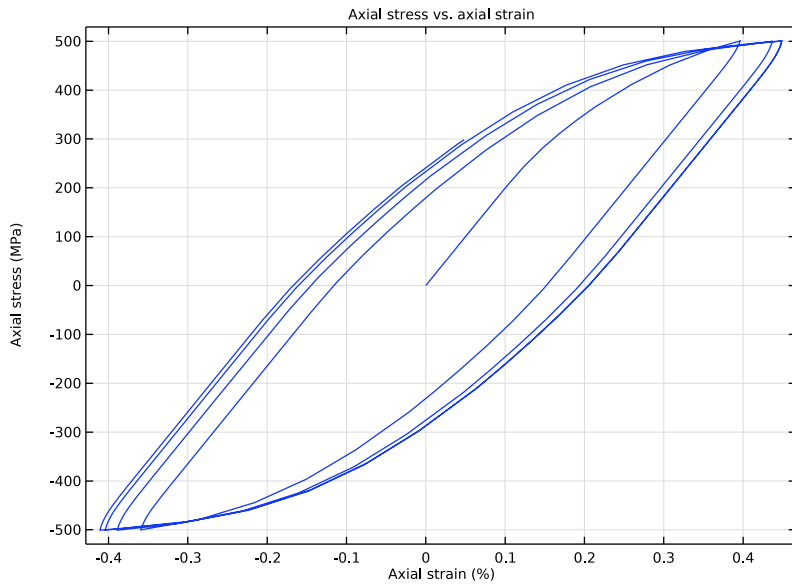

Figure 4: Axial stress versus axial strain for a symmetric prescribed stress loading.

NONSYMMETRIC STRAIN CYCLES

When the average strain is not zero in a prescribed strain cycle as in [Figure 5](#), the initial asymmetry in the axial stress gradually disappears over the cycles: This happens because of the stress relaxation effect, which is observed in many alloys.

Once a stabilized cycle is reached, the tensile and compressive stresses are equal in absolute value. This is an effect of the nonlinear kinematic hardening rule. Applying linear kinematic hardening only (or isotropic hardening) would not allow to observe the relaxation of the mean stress, so a nonlinear kinematic hardening rule is needed to model stress relaxation.

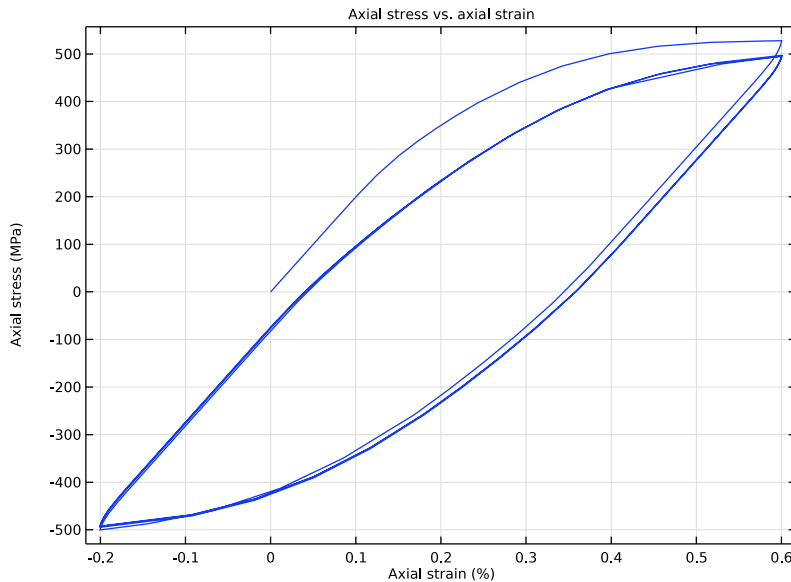

Figure 5: Axial stress versus axial strain for a nonsymmetric prescribed strain loading.

NONSYMMETRIC STRESS CYCLES

The gradual deformation that occurs in tension-compression cycles when the mean stress is nonzero is called the ratcheting effect. The ratcheting effect is most pronounced when the lower stress limit is $-\sigma_{ys0}$. This behavior is possible to observe thanks to the nonlinear kinematic hardening rule.

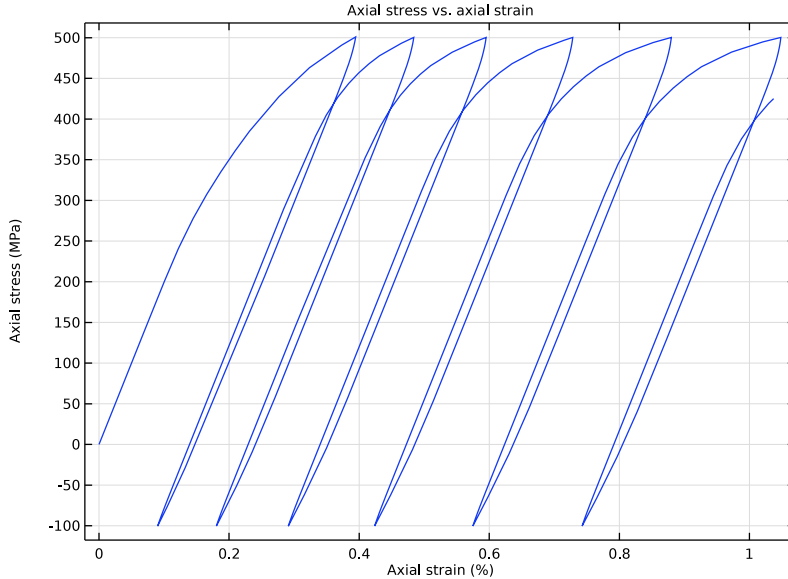

Figure 6: Axial stress versus axial strain for a nonsymmetric prescribed stress loading.

Notes About the COMSOL Implementation

Several yield functions and plastic potentials are available in the **Viscoplasticity** node. Use the von Mises equivalent stress to reproduce the results described in [Ref. 1](#).

Solve four studies to account for the different types of load cycles: the load cycle can be symmetric or nonsymmetric, and the control can be done by prescribing either the axial strain or the axial stress.

Apply a constant axial velocity on one end of the test specimen to avoid using complicated loading functions. Multiply this axial velocity by 1 to represent axial tension, or by -1 to represent axial compression.

To achieve this, define a discrete state called **LoadingType** in an Events interface. Add **Indicator States** in the Events interface to define tension and compression limits based on

the stress or strain state. For instance, for a symmetric loading cycle with a prescribed strain of 0.4% the following **Indicator States** are used:

Tension	intop1(solid.e133)-0.004
Compression	intop1(solid.e133)+0.004

Then add two **Implicit Event** nodes to define the discrete state LoadingType: when Tension > 0, then LoadingType is set to -1, and when Compression < 0, LoadingType is set to 1.

Reference

I. J. Lemaitre and J.-L. Chaboche, *Mécanique des matériaux solides*, 2nd ed., Dunod, 2001 (in French).

Application Library path: Nonlinear_Structural_Materials_Module/
Viscoplasticity/lemaitre_chaboche_viscoplastic_model



Modeling Instructions

From the **File** menu, choose **New**.

NEW

In the **New** window, click  **Model Wizard**.

MODEL WIZARD

- 1 In the **Model Wizard** window, click  **2D Axisymmetric**.
- 2 In the **Select Physics** tree, select **Structural Mechanics > Solid Mechanics (solid)**.
- 3 Click **Add**.
- 4 In the **Select Physics** tree, select **Mathematics > ODE and DAE Interfaces > Events (ev)**.
- 5 Click **Add**.
- 6 Click  **Study**.
- 7 In the **Select Study** tree, select **General Studies > Time Dependent**.
- 8 Click  **Done**.

GLOBAL DEFINITIONS

Parameters 1



Define the parameters that will be needed in the model.

- 1 In the **Model Builder** window, under **Global Definitions** click **Parameters 1**.
- 2 In the **Settings** window for **Parameters**, locate the **Parameters** section.
- 3 In the table, enter the following settings:

Name	Expression	Value	Description
e0t	1e-3[1/s]	0.001 1/s	Prescribed strain rate
L0	(35/2+14+10) [mm]	0.0415 m	Half length
gamma0	1200	1200	Initial kinematic hardening parameter
gammas	1540	1540	Saturation kinematic hardening parameter
beta	1000	1000	Kinematic hardening parameter exponent

Add a step function to apply the load smoothly.

Step 1 (step1)

- 1 In the **Home** toolbar, click  **Functions** and choose **Global > Step**.
- 2 In the **Settings** window for **Step**, locate the **Parameters** section.
- 3 In the **Location** text field, type 5[ms].
- 4 Click to expand the **Smoothing** section. In the **Size of transition zone** text field, type 0.01.
- 5 Click  **Plot**.

GEOMETRY 1

- 1 In the **Model Builder** window, under **Component 1 (comp1)** click **Geometry 1**.
- 2 In the **Settings** window for **Geometry**, locate the **Units** section.
- 3 From the **Length unit** list, choose **mm**.

Rectangle 1 (r1)

- 1 In the **Geometry** toolbar, click  **Rectangle**.
- 2 In the **Settings** window for **Rectangle**, locate the **Size and Shape** section.
- 3 In the **Width** text field, type 7/2.
- 4 In the **Height** text field, type 35/2.



Rectangle 2 (r2)

- 1 In the **Geometry** toolbar, click  **Rectangle**.
- 2 In the **Settings** window for **Rectangle**, locate the **Size and Shape** section.
- 3 In the **Width** text field, type 5.
- 4 In the **Height** text field, type 10.
- 5 Locate the **Position** section. In the **z** text field, type 21.5.

Rectangle 3 (r3)

- 1 In the **Geometry** toolbar, click  **Rectangle**.
- 2 In the **Settings** window for **Rectangle**, locate the **Size and Shape** section.
- 3 In the **Width** text field, type 8.
- 4 In the **Height** text field, type 10.
- 5 Locate the **Position** section. In the **z** text field, type 31.5.



Circular Arc 1 (ca1)

- 1 In the **Geometry** toolbar, click  **More Primitives** and choose **Circular Arc**.
- 2 In the **Settings** window for **Circular Arc**, locate the **Properties** section.
- 3 From the **Specify** list, choose **Endpoints and start angle**.
- 4 Locate the **Starting Point** section. In the **r** text field, type 3.5.
- 5 In the **z** text field, type 17.5.
- 6 Locate the **Endpoint** section. In the **r** text field, type 5.
- 7 In the **z** text field, type 21.5.
- 8 Locate the **Angles** section. In the **Start angle** text field, type 180.
- 9 Select the **Clockwise** checkbox.
- 10 Click  **Build Selected**.

Polygon 1 (pol1)

- 1 In the **Geometry** toolbar, click  **Polygon**.
- 2 In the **Settings** window for **Polygon**, locate the **Object Type** section.
- 3 From the **Type** list, choose **Open curve**.
- 4 Locate the **Coordinates** section. From the **Data source** list, choose **Vectors**.
- 5 In the **r** text field, type 5 0 0 3.5.
- 6 In the **z** text field, type 21.5 21.5 17.5 17.5.

Convert to Solid I (csoll)

- 1 In the **Geometry** toolbar, click  **Conversions** and choose **Convert to Solid**.
- 2 Select the objects **cal** and **poll** only.
- 3 In the **Settings** window for **Convert to Solid**, click  **Build All Objects**.

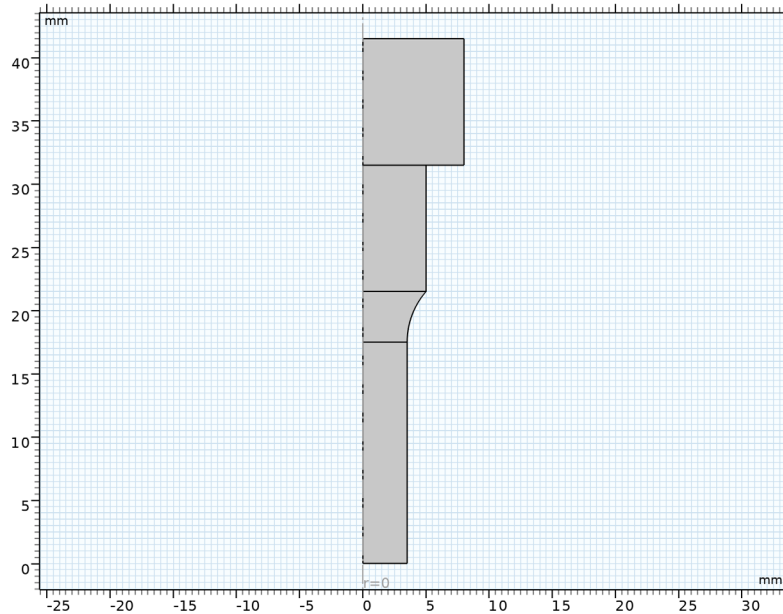

Add conditions to toggle the boundary conditions between tension and compression. This is controlled by the **Events** interface. First create a nonlocal integration coupling to evaluate variables in a point in the geometry.

DEFINITIONS

Integration I (intop1)

- 1 In the **Definitions** toolbar, click  **Nonlocal Couplings** and choose **Integration**.
- 2 In the **Settings** window for **Integration**, locate the **Source Selection** section.
- 3 From the **Geometric entity level** list, choose **Point**.
- 4 Select Point 6 only.
- 5 Locate the **Advanced** section. Clear the **Compute integral in revolved geometry** checkbox.

EVENTS (EV)

Discrete States I

- 1 In the **Physics** toolbar, click  **Global** and choose **Discrete States**.
- 2 In the **Settings** window for **Discrete States**, locate the **Discrete States** section.
- 3 In the table, enter the following settings:

Name	Initial value (u0)	Description
LoadingType	1	

The LoadingType variable is 1 when tension is applied, and -1 when compression is applied.

The first indicator state is used to control the loading with a strain measure. The tension and compression limits are symmetric.

Indicator States: Strain, Symmetric

- 1 In the **Physics** toolbar, click  **Global** and choose **Indicator States**.
- 2 In the **Settings** window for **Indicator States**, type Indicator States: Strain, Symmetric in the **Label** text field.
- 3 Locate the **Indicator Variables** section. In the table, enter the following settings:

Name	$g(\mathbf{v}, \mathbf{v}_t, \mathbf{v}_{tt}, t)$
Tension	<code>intop1(solid.e133)-0.004</code>
Compression	<code>intop1(solid.e133)+0.004</code>

The second indicator state is used to control the loading with a stress measure. The tension and compression limits are symmetric.

Indicator States: Stress, Symmetric

- 1 In the **Physics** toolbar, click  **Global** and choose **Indicator States**.
- 2 In the **Settings** window for **Indicator States**, type Indicator States: Stress, Symmetric in the **Label** text field.
- 3 Locate the **Indicator Variables** section. In the table, enter the following settings:

Name	$g(\mathbf{v}, \mathbf{v}_t, \mathbf{v}_{tt}, t)$
Tension	<code>intop1(solid.s133)-500[MPa]</code>
Compression	<code>intop1(solid.s133)+500[MPa]</code>

The third indicator state is used to control the loading with a strain measure. The tension and compression limits are nonsymmetric.

Indicator States: Strain, Nonsymmetric

- 1 In the **Physics** toolbar, click  **Global** and choose **Indicator States**.
- 2 In the **Settings** window for **Indicator States**, type Indicator States: Strain, Nonsymmetric in the **Label** text field.
- 3 Locate the **Indicator Variables** section. In the table, enter the following settings:

Name	$g(\mathbf{v}, \mathbf{v}_t, \mathbf{v}_{tt}, t)$
Tension	<code>intop1(solid.e133)-0.006</code>
Compression	<code>intop1(solid.e133)+0.002</code>

The fourth indicator state is used to control the loading with a stress measure. The tension and compression limits are nonsymmetric.

Indicator States: Stress, Nonsymmetric

- 1 In the **Physics** toolbar, click  **Global** and choose **Indicator States**.
- 2 In the **Settings** window for **Indicator States**, type Indicator States: Stress, Nonsymmetric in the **Label** text field.
- 3 Locate the **Indicator Variables** section. In the table, enter the following settings:

Name	$g(\mathbf{v}, \mathbf{v}_t, \mathbf{v}_{tt}, t)$
Tension	<code>intop1(solid.s133)-500[MPa]</code>
Compression	<code>intop1(solid.s133)+100[MPa]</code>

Implicit Event 1

- 1 In the **Physics** toolbar, click  **Global** and choose **Implicit Event**.
- 2 In the **Settings** window for **Implicit Event**, locate the **Event Conditions** section.
- 3 In the **Condition** text field, type Tension>0.
- 4 Locate the **Reinitialization** section. In the table, enter the following settings:

	Expression
LoadingType	-1

Implicit Event 2

- 1 In the **Physics** toolbar, click  **Global** and choose **Implicit Event**.
- 2 In the **Settings** window for **Implicit Event**, locate the **Event Conditions** section.
- 3 In the **Condition** text field, type Compression<0.

4 Locate the **Reinitialization** section. In the table, enter the following settings:

	Expression
LoadingType	1

SOLID MECHANICS (SOLID)

- 1 In the **Model Builder** window, under **Component 1 (comp1)** click **Solid Mechanics (solid)**.
- 2 In the **Settings** window for **Solid Mechanics**, locate the **Structural Transient Behavior** section.
- 3 From the list, choose **Quasistatic**.

Symmetry Plane 1

- 1 In the **Physics** toolbar, click  **Boundaries** and choose **Symmetry Plane**.
- 2 Select Boundary 2 only.

Prescribed Velocity 1

- 1 In the **Physics** toolbar, click  **Boundaries** and choose **Prescribed Velocity**.
- 2 Select Boundary 9 only.
- 3 In the **Settings** window for **Prescribed Velocity**, locate the **Prescribed Velocity** section.
- 4 Select the **Prescribed in z direction** checkbox.
- 5 In the v_z text field, type $e0t*L0*step1(t)*LoadingType$.

Linear Elastic Material 1

Add a **Viscoplasticity** subnode with combined isotropic and kinematic hardening.

- 1 In the **Model Builder** window, click **Linear Elastic Material 1**.

Viscoplasticity 1

- 1 In the **Physics** toolbar, click  **Attributes** and choose **Viscoplasticity**.
- 2 Select Domains 1–3 only.
- 3 In the **Settings** window for **Viscoplasticity**, locate the **Viscoplasticity Model** section.
- 4 From the **Material model** list, choose **Chaboche**.
- 5 Find the **Isotropic hardening model** subsection. From the list, choose **Voce**.
- 6 Find the **Kinematic hardening model** subsection. From the list, choose **Armstrong-Frederick**.

Set the material properties.

MATERIALS

Material I (matI)

- 1 In the **Model Builder** window, under **Component 1 (comp1)** right-click **Materials** and choose **Blank Material**.
- 2 In the **Settings** window for **Material**, locate the **Material Contents** section.
- 3 In the table, enter the following settings:

Property	Variable	Value	Unit	Property group
Young's modulus	E	200 [GPa]	Pa	Young's modulus and Poisson's ratio
Poisson's ratio	nu	0.3	l	Young's modulus and Poisson's ratio
Density	rho	7500	kg/m ³	Basic
Viscoplastic rate coefficient	A_cha	1	l/s	Chaboche viscoplasticity
Reference stress	sigRef_cha	490 [MPa]	N/m ²	Chaboche viscoplasticity
Stress exponent	n_cha	9	l	Chaboche viscoplasticity
Initial yield stress	sigmags	60 [MPa]	Pa	Elastoplastic material model
Saturation flow stress	sigma_voc	-35 [MPa]	Pa	Voce
Saturation exponent	beta_voc	200	l	Voce
Kinematic hardening modulus	Ck	362.5 [GPa]	Pa	Armstrong-Frederick

The kinematic hardening parameter γ_{mak} is a nonlinear function of the equivalent viscoplastic strain. Add the latter from the model input list to make it available.

- 4 In the **Model Builder** window, expand the **Material I (matI)** node, then click **Armstrong-Frederick (ArmstrongFrederick)**.
- 5 In the **Settings** window for **Armstrong-Frederick**, locate the **Model Inputs** section.
- 6 Click **+ Select Quantity**.
- 7 In the **Physical Quantity** dialog, type **viscoplastic** in the text field.
- 8 In the tree, select **Solid Mechanics > Equivalent viscoplastic strain (I)**.

9 Click **OK**.

10 In the **Settings** window for **Armstrong–Frederick**, locate the **Output Properties** section.

11 In the table, enter the following settings:

Property	Variable	Expression	Unit	Size
Kinematic hardening parameter	gammak	$\text{gammas} + (\text{gamma}0 - \text{gammas}) * \exp(-\text{beta} * \text{evpe})$	1	x

Create a mapped mesh.

MESH 1

Mapped 1

In the **Mesh** toolbar, click  **Mapped**.

Distribution 1

- 1 Right-click **Mapped 1** and choose **Distribution**.
- 2 Select Boundary 8 only.
- 3 In the **Settings** window for **Distribution**, locate the **Distribution** section.
- 4 In the **Number of elements** text field, type 4.

Distribution 2

- 1 In the **Model Builder** window, right-click **Mapped 1** and choose **Distribution**.
- 2 Select Boundary 12 only.
- 3 In the **Settings** window for **Distribution**, locate the **Distribution** section.
- 4 In the **Number of elements** text field, type 2.

Distribution 3

- 1 Right-click **Mapped 1** and choose **Distribution**.
- 2 Select Boundary 10 only.
- 3 In the **Settings** window for **Distribution**, locate the **Distribution** section.
- 4 In the **Number of elements** text field, type 16.
- 5 Select Boundary 1 only.

Distribution 4

- 1 Right-click **Mapped 1** and choose **Distribution**.
- 2 Select Boundary 3 only.
- 3 In the **Settings** window for **Distribution**, locate the **Distribution** section.

4 In the **Number of elements** text field, type 4.

Distribution 5

1 Right-click **Mapped 1** and choose **Distribution**.

2 Select Boundary 5 only.

Distribution 6

1 Right-click **Mapped 1** and choose **Distribution**.

2 Select Boundary 7 only.

3 In the **Settings** window for **Distribution**, locate the **Distribution** section.

4 In the **Number of elements** text field, type 3.

5 Click  **Build All**.

6 In the **Model Builder** window, click **Mesh 1**.

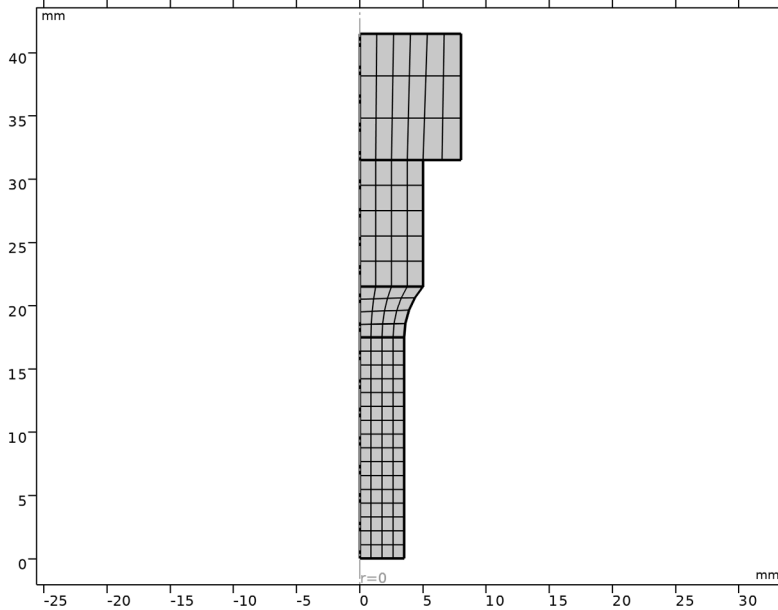

STUDY I



Step 1: Time Dependent

1 In the **Model Builder** window, under **Study I** click **Step 1: Time Dependent**.

2 In the **Settings** window for **Time Dependent**, locate the **Study Settings** section.

- 3 In the **Output times** text field, type 0 40.
For the first study, control the loading with symmetric strain cycles.
- 4 Locate the **Physics and Variables Selection** section. Select the **Modify model configuration for study step** checkbox.
- 5 In the tree, select **Component 1 (comp1) > Events (ev) > Indicator States: Stress, Symmetric, Component 1 (comp1) > Events (ev) > Indicator States: Strain, Nonsymmetric,** and **Component 1 (comp1) > Events (ev) > Indicator States: Stress, Nonsymmetric.**
- 6 Click  **Disable.**



Solution 1 (sol1)

- 1 In the **Study** toolbar, click  **Show Default Solver.**
- 2 In the **Model Builder** window, expand the **Solution 1 (sol1)** node, then click **Time-Dependent Solver 1.**
- 3 In the **Settings** window for **Time-Dependent Solver**, click to expand the **Time Stepping** section.
- 4 In the **Event tolerance** text field, type 0.001.
- 5 Click to expand the **Output** section. Locate the **General** section. From the **Times to store** list, choose **Steps taken by solver.**
Only the start and end times are defined in the **Time Dependent** study step. For intermediate times, store the results for all time steps taken by the solver.
- 6 Locate the **Output** section. Clear the **Store the first time derivative** checkbox.
- 7 In the **Model Builder** window, click **Study 1.**
- 8 In the **Settings** window for **Study**, type Study 1, Prescribed Symmetric Strain in the **Label** text field.
- 9 Locate the **Study Settings** section. Clear the **Generate default plots** checkbox.
- 10 In the **Study** toolbar, click  **Compute.**

Set default units for result presentation.

RESULTS

Preferred Units 1

- 1 In the **Results** toolbar, click  **Configurations** and choose **Preferred Units.**
- 2 In the **Settings** window for **Preferred Units**, locate the **Units** section.
- 3 Click  **Add Physical Quantity.**
- 4 In the **Physical Quantity** dialog, select **Solid Mechanics > Strain tensor (I)** in the tree.

5 Click **OK**.

6 In the **Settings** window for **Preferred Units**, locate the **Units** section.

7 In the table, enter the following settings:

Quantity	Unit	Preferred unit
Strain tensor	I	%

8 Click  **Add Physical Quantity**.

9 In the **Physical Quantity** dialog, select **Solid Mechanics** > **Stress tensor (N/m²)** in the tree.

10 Click **OK**.

11 In the **Settings** window for **Preferred Units**, locate the **Units** section.

12 In the table, enter the following settings:

Quantity	Unit	Preferred unit
Stress tensor	N/m ²	MPa

13 Select the **Apply conversions to expressions with the same dimensions** checkbox.

14 Click  **Apply**.

Create a first group of plots for the results of the first study.

Prescribed Symmetric Strain

1 In the **Model Builder** window, right-click **Results** and choose **Node Group**.

2 In the **Settings** window for **Group**, type **Prescribed Symmetric Strain** in the **Label** text field.

3 Right-click **Prescribed Symmetric Strain** and choose **Move to Plot Groups**.

Add a first plot group to reproduce [Figure 3](#).

Stress vs. Strain I

1 In the **Results** toolbar, click  **ID Plot Group**.

Add a plot group to reproduce [Figure 2](#).

2 In the **Settings** window for **ID Plot Group**, type **Stress vs. Strain 1** in the **Label** text field.

3 Locate the **Plot Settings** section.



4 Select the **x-axis label** checkbox. In the associated text field, type **Axial strain (%)**.

5 Select the **y-axis label** checkbox. In the associated text field, type **Axial stress (MPa)**.

6 Click to expand the **Title** section. From the **Title type** list, choose **Manual**.

7 In the **Title** text area, type Axial stress vs. axial strain.

Point Graph 1

- 1 In the **Stress vs. Strain 1** toolbar, click  **Point Graph**.
- 2 Select Point 6 only.
- 3 In the **Settings** window for **Point Graph**, click **Replace Expression** in the upper-right corner of the **y-Axis Data** section. From the menu, choose **Component 1 (comp1) > Solid Mechanics > Stress > Stress tensor, local coordinate system - N/m² > solid.slGp33 - Stress tensor, local coordinate system, 33-component**.
- 4 Locate the **x-Axis Data** section. From the **Parameter** list, choose **Expression**.
- 5 Click **Replace Expression** in the upper-right corner of the **x-Axis Data** section. From the menu, choose **Component 1 (comp1) > Solid Mechanics > Strain > Strain tensor, local coordinate system > solid.el33 - Strain tensor, local coordinate system, 33-component**.
- 6 In the **Stress vs. Strain 1** toolbar, click  **Plot**.

Stresses vs. Time 1

- 1 In the **Results** toolbar, click  **ID Plot Group**.
- 2 In the **Settings** window for **ID Plot Group**, type Stresses vs. Time 1 in the **Label** text field.
- 3 Locate the **Title** section. From the **Title type** list, choose **Manual**.
- 4 In the **Title** text area, type Stresses vs. time.

Point Graph 1

- 1 Right-click **Stresses vs. Time 1** and choose **Point Graph**.
- 2 Select Point 6 only.
- 3 In the **Settings** window for **Point Graph**, click **Replace Expression** in the upper-right corner of the **y-Axis Data** section. From the menu, choose **Component 1 (comp1) > Solid Mechanics > Stress > Stress tensor, local coordinate system - N/m² > solid.slGp33 - Stress tensor, local coordinate system, 33-component**.
- 4 Click to expand the **Title** section. From the **Title type** list, choose **None**.
- 5 Click to expand the **Legends** section. Select the **Show legends** checkbox.
- 6 From the **Legends** list, choose **Manual**.
- 7 In the table, enter the following settings:

Legends
Axial stress

Point Graph 2

- 1 Right-click **Point Graph 1** and choose **Duplicate**.
- 2 In the **Settings** window for **Point Graph**, locate the **y-Axis Data** section.
- 3 In the **Expression** text field, type `max(0, solid.1emm1.vp11.Fyield)`.
- 4 Locate the **Legends** section. In the table, enter the following settings:

Legends
Viscous stress

Point Graph 3

- 1 Right-click **Point Graph 2** and choose **Duplicate**.
- 2 In the **Settings** window for **Point Graph**, locate the **y-Axis Data** section.
- 3 In the **Expression** text field, type `solid.1emm1.vp11.S1_back33`.
- 4 Locate the **Legends** section. In the table, enter the following settings:

Legends
Back stress

Point Graph 4

- 1 Right-click **Point Graph 3** and choose **Duplicate**.
- 2 In the **Settings** window for **Point Graph**, locate the **y-Axis Data** section.
- 3 In the **Expression** text field, type `solid.1emm1.vp11.sY`.
- 4 Locate the **Legends** section. In the table, enter the following settings:

Legends
Yield strength

Stresses vs. Time 1

- 1 In the **Model Builder** window, click **Stresses vs. Time 1**.
- 2 In the **Settings** window for **ID Plot Group**, locate the **Plot Settings** section.
- 3 Select the **y-axis label** checkbox. In the associated text field, type `Stress (MPa)`.
- 4 In the **Stresses vs. Time 1** toolbar, click  **Plot**.

Plot the equivalent viscoplastic strain on the whole geometry.

Revolution 2D 1

- In the **Results** toolbar, click  **More Datasets** and choose **Revolution 2D**.

Mirror 3D 1

- 1 In the **Results** toolbar, click  **More Datasets** and choose **Mirror 3D**.
- 2 In the **Settings** window for **Mirror 3D**, locate the **Plane Data** section.
- 3 From the **Plane** list, choose **XY-planes**.

Equivalent Viscoplastic Strain 1

- 1 In the **Results** toolbar, click  **3D Plot Group**.
- 2 In the **Settings** window for **3D Plot Group**, type Equivalent Viscoplastic Strain 1 in the **Label** text field.
- 3 Locate the **Data** section. From the **Dataset** list, choose **Mirror 3D 1**.
- 4 Locate the **Plot Settings** section. Clear the **Plot dataset edges** checkbox.

Surface 1

- 1 Right-click **Equivalent Viscoplastic Strain 1** and choose **Surface**.
- 2 In the **Settings** window for **Surface**, click **Replace Expression** in the upper-right corner of the **Expression** section. From the menu, choose **Component 1 (comp 1) > Solid Mechanics > Strain > solid.evpeGp - Equivalent viscoplastic strain - 1**.
- 3 Locate the **Coloring and Style** section. From the **Color table** list, choose **AuroraAustralisDark**.

Deformation 1

Right-click **Surface 1** and choose **Deformation**.

Surface 2

- 1 In the **Model Builder** window, right-click **Equivalent Viscoplastic Strain 1** and choose **Surface**.
- 2 In the **Settings** window for **Surface**, locate the **Expression** section.
- 3 In the **Expression** text field, type 0.
- 4 Click to expand the **Title** section. From the **Title type** list, choose **None**.
- 5 Click to expand the **Inherit Style** section. From the **Plot** list, choose **Surface 1**.

Deformation 1

Right-click **Surface 2** and choose **Deformation**.

Selection 1

- 1 In the **Model Builder** window, right-click **Surface 2** and choose **Selection**.
- 2 Select Domain 4 only.

3 In the **Equivalent Viscoplastic Strain I** toolbar, click  **Plot**.

Time=40 s

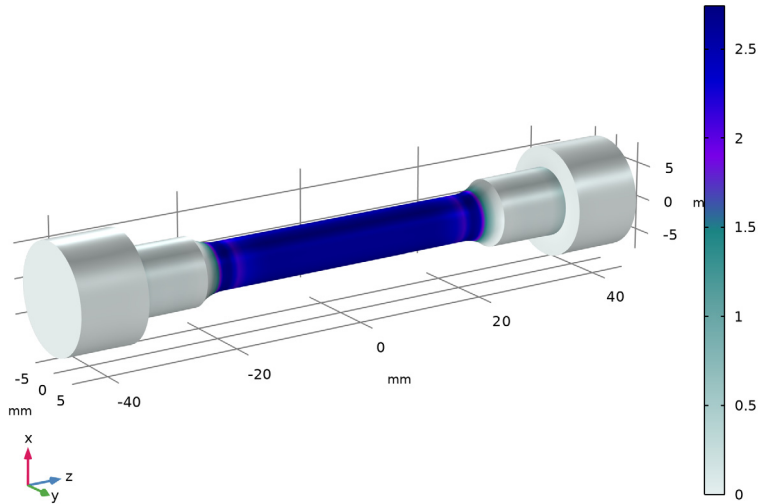

Equivalent viscoplastic strain (%)



Equivalent Viscoplastic Strain I

Add a study to compute the response when loading is controlled by symmetric stress cycles.

ADD STUDY

- 1 In the **Home** toolbar, click  **Add Study** to open the **Add Study** window.
- 2 Go to the **Add Study** window.
- 3 Find the **Studies** subsection. In the **Select Study** tree, select **General Studies** > **Time Dependent**.
- 4 Click the **Add Study** button in the window toolbar.
- 5 In the **Home** toolbar, click  **Add Study** to close the **Add Study** window.



STUDY 2

Step 1: Time Dependent

- 1 In the **Settings** window for **Time Dependent**, locate the **Study Settings** section.
- 2 In the **Output times** text field, type 0 40.

- 3 Locate the **Physics and Variables Selection** section. Select the **Modify model configuration for study step** checkbox.
- 4 In the tree, select **Component 1 (comp1) > Events (ev) > Indicator States: Strain, Symmetric, Component 1 (comp1) > Events (ev) > Indicator States: Strain, Nonsymmetric**, and **Component 1 (comp1) > Events (ev) > Indicator States: Stress, Nonsymmetric**.
- 5 Click  **Disable**.
- 6 In the **Model Builder** window, click **Study 2**.
- 7 In the **Settings** window for **Study**, type Study 2, Prescribed Symmetric Stress in the **Label** text field.
- 8 Locate the **Study Settings** section. Clear the **Generate default plots** checkbox.

Solution 2 (sol2)

- 1 In the **Study** toolbar, click  **Show Default Solver**.
- 2 In the **Model Builder** window, expand the **Solution 2 (sol2)** node, then click **Time-Dependent Solver 1**.
- 3 In the **Settings** window for **Time-Dependent Solver**, locate the **Time Stepping** section.
- 4 In the **Event tolerance** text field, type 0.001.
- 5 Locate the **General** section. From the **Times to store** list, choose **Steps taken by solver**.
- 6 Locate the **Output** section. Clear the **Store the first time derivative** checkbox.
- 7 In the **Study** toolbar, click  **Compute**.

RESULTS

Revolution 2D 2

- 1 In the **Results** toolbar, click  **More Datasets** and choose **Revolution 2D**.
- 2 In the **Settings** window for **Revolution 2D**, locate the **Data** section.
- 3 From the **Dataset** list, choose **Study 2, Prescribed Symmetric Stress/Solution 2 (sol2)**.

Mirror 3D 2

- 1 In the **Results** toolbar, click  **More Datasets** and choose **Mirror 3D**.
- 2 In the **Settings** window for **Mirror 3D**, locate the **Data** section.
- 3 From the **Dataset** list, choose **Revolution 2D 2**.
- 4 Locate the **Plane Data** section. From the **Plane** list, choose **XY-planes**.

Prescribed Symmetric Stress

- 1 In the **Model Builder** window, right-click **Prescribed Symmetric Strain** and choose **Duplicate**.

- 2 In the **Settings** window for **Group**, type Prescribed Symmetric Stress in the **Label** text field.

Stress vs. Strain 2

- 1 In the **Model Builder** window, expand the **Prescribed Symmetric Stress** node, then click **Stress vs. Strain 1.1**.
- 2 In the **Settings** window for **ID Plot Group**, type Stress vs. Strain 2 in the **Label** text field.
- 3 Locate the **Data** section. From the **Dataset** list, choose **Study 2, Prescribed Symmetric Stress/Solution 2 (sol2)**.
- 4 In the **Stress vs. Strain 2** toolbar, click  **Plot**.

Stresses vs. Time 2

- 1 In the **Model Builder** window, under **Results > Prescribed Symmetric Stress** click **Stresses vs. Time 1.1**.
- 2 In the **Settings** window for **ID Plot Group**, type Stresses vs. Time 2 in the **Label** text field.
- 3 Locate the **Data** section. From the **Dataset** list, choose **Study 2, Prescribed Symmetric Stress/Solution 2 (sol2)**.

Equivalent Viscoplastic Strain 2

- 1 In the **Model Builder** window, under **Results > Prescribed Symmetric Stress** click **Equivalent Viscoplastic Strain 1.1**.
- 2 In the **Settings** window for **3D Plot Group**, type Equivalent Viscoplastic Strain 2 in the **Label** text field.
- 3 Locate the **Data** section. From the **Dataset** list, choose **Mirror 3D 2**.
- 4 Locate the **Plot Settings** section. From the **View** list, choose **View 3D 3**.
- 5 In the **Equivalent Viscoplastic Strain 2** toolbar, click  **Plot**.

Add a study to compute the response when loading is controlled by nonsymmetric strain cycles.

ADD STUDY

- 1 In the **Home** toolbar, click  **Add Study** to open the **Add Study** window.
- 2 Go to the **Add Study** window.
- 3 Find the **Studies** subsection. In the **Select Study** tree, select **General Studies > Time Dependent**.
- 4 Click the **Add Study** button in the window toolbar.



5 In the **Home** toolbar, click  **Add Study** to close the **Add Study** window.

STUDY 3

Step 1: Time Dependent

- 1 In the **Settings** window for **Time Dependent**, locate the **Study Settings** section.
- 2 In the **Output times** text field, type 0 40.
- 3 Locate the **Physics and Variables Selection** section. Select the **Modify model configuration for study step** checkbox.
- 4 In the tree, select **Component 1 (comp1) > Events (ev) > Indicator States: Strain, Symmetric**, **Component 1 (comp1) > Events (ev) > Indicator States: Stress, Symmetric**, and **Component 1 (comp1) > Events (ev) > Indicator States: Stress, Nonsymmetric**.
- 5 Click  **Disable**.

Solution 3 (sol3)

- 1 In the **Study** toolbar, click  **Show Default Solver**.
- 2 In the **Model Builder** window, expand the **Solution 3 (sol3)** node, then click **Time-Dependent Solver 1**.
- 3 In the **Settings** window for **Time-Dependent Solver**, locate the **Time Stepping** section.
- 4 In the **Event tolerance** text field, type 0.001.
- 5 Locate the **General** section. From the **Times to store** list, choose **Steps taken by solver**.
- 6 Locate the **Output** section. Clear the **Store the first time derivative** checkbox.
- 7 In the **Model Builder** window, click **Study 3**.
- 8 In the **Settings** window for **Study**, type Study 3, Prescribed Nonsymmetric Strain in the **Label** text field.
- 9 Locate the **Study Settings** section. Clear the **Generate default plots** checkbox.
- 10 In the **Study** toolbar, click  **Compute**.

RESULTS

Revolution 2D 3

- 1 In the **Results** toolbar, click  **More Datasets** and choose **Revolution 2D**.
- 2 In the **Settings** window for **Revolution 2D**, locate the **Data** section.
- 3 From the **Dataset** list, choose **Study 3, Prescribed Nonsymmetric Strain/Solution 3 (sol3)**.

Mirror 3D 3

- 1 In the **Results** toolbar, click  **More Datasets** and choose **Mirror 3D**.

- 2 In the **Settings** window for **Mirror 3D**, locate the **Data** section.
- 3 From the **Dataset** list, choose **Revolution 2D 3**.
- 4 Locate the **Plane Data** section. From the **Plane** list, choose **XY-planes**.

Prescribed Nonsymmetric Strain

- 1 In the **Model Builder** window, right-click **Prescribed Symmetric Strain** and choose **Duplicate**.
- 2 In the **Settings** window for **Group**, type Prescribed Nonsymmetric Strain in the **Label** text field.

Stress vs. Strain 3

- 1 In the **Model Builder** window, expand the **Prescribed Nonsymmetric Strain** node, then click **Stress vs. Strain 1.1**.
- 2 In the **Settings** window for **ID Plot Group**, type Stress vs. Strain 3 in the **Label** text field.
- 3 Locate the **Data** section. From the **Dataset** list, choose **Study 3, Prescribed Nonsymmetric Strain/Solution 3 (sol3)**.
- 4 In the **Stress vs. Strain 3** toolbar, click  **Plot**.

Stresses vs. Time 3



- 1 In the **Model Builder** window, under **Results > Prescribed Nonsymmetric Strain** click **Stresses vs. Time 1.1**.
- 2 In the **Settings** window for **ID Plot Group**, type Stresses vs. Time 3 in the **Label** text field.
- 3 Locate the **Data** section. From the **Dataset** list, choose **Study 3, Prescribed Nonsymmetric Strain/Solution 3 (sol3)**.

Equivalent Viscoplastic Strain 3

- 1 In the **Model Builder** window, under **Results > Prescribed Nonsymmetric Strain** click **Equivalent Viscoplastic Strain 1.1**.
- 2 In the **Settings** window for **3D Plot Group**, type Equivalent Viscoplastic Strain 3 in the **Label** text field.
- 3 Locate the **Data** section. From the **Dataset** list, choose **Mirror 3D 3**.
- 4 Locate the **Plot Settings** section. From the **View** list, choose **View 3D 3**.
- 5 In the **Equivalent Viscoplastic Strain 3** toolbar, click  **Plot**.

Add a study to compute the response when loading is controlled by nonsymmetric stress cycles.

ADD STUDY



- 1 In the **Home** toolbar, click  **Add Study** to open the **Add Study** window.
- 2 Go to the **Add Study** window.
- 3 Find the **Studies** subsection. In the **Select Study** tree, select **General Studies** > **Time Dependent**.
- 4 Click the **Add Study** button in the window toolbar.
- 5 In the **Home** toolbar, click  **Add Study** to close the **Add Study** window.

STUDY 4

Step 1: Time Dependent

- 1 In the **Settings** window for **Time Dependent**, locate the **Study Settings** section.
- 2 In the **Output times** text field, type 0 30.
- 3 Locate the **Physics and Variables Selection** section. Select the **Modify model configuration for study step** checkbox.
- 4 In the tree, select **Component 1 (comp1)** > **Events (ev)** > **Indicator States: Strain, Symmetric**, **Component 1 (comp1)** > **Events (ev)** > **Indicator States: Stress, Symmetric**, and **Component 1 (comp1)** > **Events (ev)** > **Indicator States: Strain, Nonsymmetric**.
- 5 Click  **Disable**.

Solution 4 (sol4)

- 1 In the **Study** toolbar, click  **Show Default Solver**.
- 2 In the **Model Builder** window, expand the **Solution 4 (sol4)** node, then click **Time-Dependent Solver 1**.
- 3 In the **Settings** window for **Time-Dependent Solver**, locate the **Time Stepping** section.
- 4 In the **Event tolerance** text field, type 0.001.
- 5 Locate the **General** section. From the **Times to store** list, choose **Steps taken by solver**.
- 6 Locate the **Output** section. Clear the **Store the first time derivative** checkbox.
- 7 In the **Model Builder** window, click **Study 4**.
- 8 In the **Settings** window for **Study**, type Study 4, Prescribed Nonsymmetric Stress in the **Label** text field.
- 9 Locate the **Study Settings** section. Clear the **Generate default plots** checkbox.
- 10 In the **Study** toolbar, click  **Compute**.

RESULTS

Revolution 2D 4

- 1 In the **Results** toolbar, click  **More Datasets** and choose **Revolution 2D**.
- 2 In the **Settings** window for **Revolution 2D**, locate the **Data** section.
- 3 From the **Dataset** list, choose **Study 4, Prescribed Nonsymmetric Stress/Solution 4 (sol4)**.

Mirror 3D 4

- 1 In the **Results** toolbar, click  **More Datasets** and choose **Mirror 3D**.
- 2 In the **Settings** window for **Mirror 3D**, locate the **Data** section.
- 3 From the **Dataset** list, choose **Revolution 2D 4**.
- 4 Locate the **Plane Data** section. From the **Plane** list, choose **XY-planes**.

Prescribed Nonsymmetric Stress

- 1 In the **Model Builder** window, right-click **Prescribed Symmetric Strain** and choose **Duplicate**.
- 2 In the **Settings** window for **Group**, type Prescribed Nonsymmetric Stress in the **Label** text field.

Stress vs. Strain 4

- 1 In the **Model Builder** window, expand the **Prescribed Nonsymmetric Stress** node, then click **Stress vs. Strain 1.1**.
- 2 In the **Settings** window for **ID Plot Group**, type Stress vs. Strain 4 in the **Label** text field.
- 3 Locate the **Data** section. From the **Dataset** list, choose **Study 4, Prescribed Nonsymmetric Stress/Solution 4 (sol4)**.
- 4 In the **Stress vs. Strain 4** toolbar, click  **Plot**.

Stresses vs. Time 4

- 1 In the **Model Builder** window, under **Results > Prescribed Nonsymmetric Stress** click **Stresses vs. Time 1.1**.
- 2 In the **Settings** window for **ID Plot Group**, type Stresses vs. Time 4 in the **Label** text field.
- 3 Locate the **Data** section. From the **Dataset** list, choose **Study 4, Prescribed Nonsymmetric Stress/Solution 4 (sol4)**.



Equivalent Viscoplastic Strain 4

- 1 In the **Model Builder** window, under **Results > Prescribed Nonsymmetric Stress** click **Equivalent Viscoplastic Strain 1.1**.

- 2 In the **Settings** window for **3D Plot Group**, type Equivalent Viscoplastic Strain 4 in the **Label** text field.
- 3 Locate the **Data** section. From the **Dataset** list, choose **Mirror 3D 4**.
- 4 Locate the **Plot Settings** section. From the **View** list, choose **View 3D 3**.
- 5 In the **Equivalent Viscoplastic Strain 4** toolbar, click  **Plot**.

Add an animation to show the increase of equivalent viscoplastic strain over time.

Equivalent Viscoplastic Strain

- 1 In the **Results** toolbar, click  **Animation** and choose **Player**.
- 2 In the **Settings** window for **Animation**, type Equivalent Viscoplastic Strain in the **Label** text field.
- 3 Locate the **Scene** section. From the **Subject** list, choose **Equivalent Viscoplastic Strain 1**.
- 4 Locate the **Frames** section. In the **Number of frames** text field, type 50.
- 5 Click the  **Play** button in the **Graphics** toolbar.