



Model created in COMSOL Multiphysics 6.4

Impact Analysis of a Golf Ball

Introduction

The outcome of a golf stroke is to a large extent influenced by the characteristics of the golf ball, including both its aerodynamics and mechanical properties. The latter, for example, determine how efficiently energy is transferred from the club head to the ball during the swing. The transfer of energy is largely governed by the stiffness of the ball's core material, or in golf nomenclature, the "compression" of the ball. How well energy is transferred during the impact plays a key role in how far the ball will fly. The "backspin" is another key aspect of the golf stroke influenced by the mechanical properties of the ball. A high spin rate increases the lift, lengthening the carry distance of the shot. Also, increasing the backspin makes the ball stop more rapidly when landing. The stiffness of the cover and core materials plays an important role for the friction and spinning effects. A ball with a thin cover and a soft core will deform more when it comes in contact with the club face, thus generating more friction and a higher spin rate.

This example studies the mechanical impact of a club on a golf ball. The contact between the two parts is modeled using a viscous penalty formulation in order to stabilize this dynamic event. To properly model large deformations, the golf ball is defined using a hyperelastic material model. Additionally, the core material is viscoelastic, which causes dissipation of the elastic energy transferred by the impact. Results are compared to typical golf metrics such as ball speed and spin rate.

Model Definition

The model studies how momentum and energy are transferred from the club to the golf ball during the swing. The simulation focuses on the impact between the two objects, and it only looks at a time period of 2 ms.

Figure 1 shows the geometry of the club and golf ball. The dimensions of the club represent a typical 7 iron with a loft equal to 34° . The club head is approximately 9 cm wide, 6 cm high at the toe, and 3.5 cm high close to the shaft. The shaft is only partially included to simplify the geometry. It is assumed that the club has a *dynamic loft* of 28° at impact. The dynamic loft is the angle of the club face from the vertical plane at impact.

The ball's diameter is 42.67 mm in accordance with the rules of golf (Ref. 1). A three piece design is used: an inner core of 34.67 mm in diameter, a 3 mm thick outer core (or mantle), and a 1 mm thick cover. The outer surface is also covered with 362 dimples.

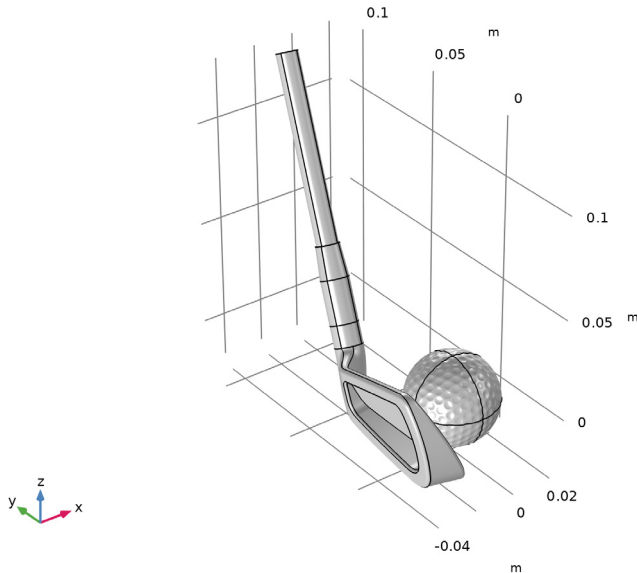

Figure 1: Model geometry.

MATERIAL MODELS AND PROPERTIES

The golf club is assumed to be made of steel, with a density of 7850 kg/m^3 , Young's modulus of 200 GPa, and Poisson's ratio of 0.3.

According to Ref. 1, the golf ball must be constructed entirely from elastomeric materials, that is, viscoelastic materials with a low stiffness. All parts of the ball are thus described using a Neo-Hookean hyperelastic material model. The cover is assumed to be compressible, while both inner and outer core are considered nearly incompressible and modeled using a mixed formulation. The Hartmann–Neff volumetric strain energy density is used with a prescribed bulk modulus of 1 GPa in order to penalize volumetric deformations. The two parts of the core are furthermore considered to be viscoelastic, and thus also include a large strain Generalized Maxwell model with three branches.

Mechanical properties of the materials used in golf balls are propriety and hard to find in the literature. Hence, the material properties summarized in Table 1 are only realistic estimates. The density is, for example, taken so that the total mass of the ball is equal to

45.93 g in accordance with Ref. 1. The other material properties have been tuned to give realistic results.

TABLE 1: MATERIAL PROPERTIES OF THE GOLF BALL.

Property	Symbol	Unit	Cover	Mantle	Inner core
Density	ρ	kg/m ³	1145	1145	1145
Lamé parameters	λ	MPa	1500	N/A	N/A
	μ	MPa	250	6	12
Energy factors	β_{v1}	l	N/A	0.26	0.26
	β_{v2}	l	N/A	0.19	0.19
	β_{v3}	l	N/A	0.22	0.22
Relaxation times	τ_{v1}	μ s	N/A	10	10
	τ_{v2}	μ s	N/A	100	100
	τ_{v3}	μ s	N/A	1000	1000

CONSTRAINTS AND CONTACT CONDITIONS

The golf club impacts the ball with a velocity equal to 90 mph in a slightly downward direction, defined by an attack angle of -4.3° from the xy -plane. The end of the shaft is constrained to this velocity throughout the simulation. Both the velocity and the attack angle are rough estimates for a professional male golf player when using a 7 iron.

The interaction between the club and the golf ball is modeled using a contact condition. Dynamic effects are important since this is a time-dependent simulation of an impact event, and linear momentum and energy must be consistent during the contact interaction. To ensure this and to stabilize the contact condition, a viscous penalty formulation is added for the pressure contact. Friction is also important to properly capture the interaction between the club and the ball; since it is the effect of friction that causes the golf ball to spin after it is hit by the club head. A Coulomb friction model is added with a friction coefficient equal to 0.15.

Results and Discussion

Table 2 presents some common metrics used in golf to measure the performance of the player and the equipment. Here, the club speed and attack angle are input data to the simulation. The remaining metrics are computed by the COMSOL Multiphysics model. The *launch angle* is the angle of the ball relative to the ground after impact, and the *smash factor* is the ball speed divided by the club speed. Given the input parameters, all

computed metrics are realistic and close to typical values reported for an average professional male golf player.

TABLE 2: METRICS OF THE CLUB AND GOLF BALL.

Club speed (mph)	Attack angle (deg)	Launch angle (deg)	Ball speed (mph)	Smash factor	Spin rate (rpm)
90	-4.3	18.7	116	1.29	6774

Figure 2 shows four snapshots of the simulation before, during, and after the impact. One can clearly see the large deformation of the golf ball when hit by the club head, increasing the contact area between the ball and the club face. This is even more visible when looking at the cut-through image in Figure 3, that also shows the strain distribution inside the ball. Figure 3 shows the minimum principal strain which is in the order of -20% in large parts of the ball.

It is interesting to look at the velocity of the club and ball during the simulation in order to study the kinematics of the problem in detail. Figure 4 shows the velocity magnitude and how momentum is transferred from the club head to the ball during the impact. Due to the flexibility of the shaft, the velocity of the club head decreases slightly during and after the impact, even though the velocity of the shaft is prescribed to a constant value.

Figure 5 shows the variation of the total elastic and kinetic energy of the golf ball during the simulation. The duration of the impact is clearly visible as a peak in both the elastic and kinetic energy content. An interesting observation is how effectively the viscoelastic properties of the core damp out the elastic energy after the impact. In contrast, the kinetic energy reaches a constant value once the ball departs from the club face.



Figure 2: Snapshots of the club and golf ball during the simulation. From top to bottom, the timings are 0 ms, 0.15 ms, 0.30 ms, and 0.45 ms.



Figure 3: Deformation of the golf ball and distribution of the third principal (compressive) strain in the interior part of the ball at 0.3 ms.

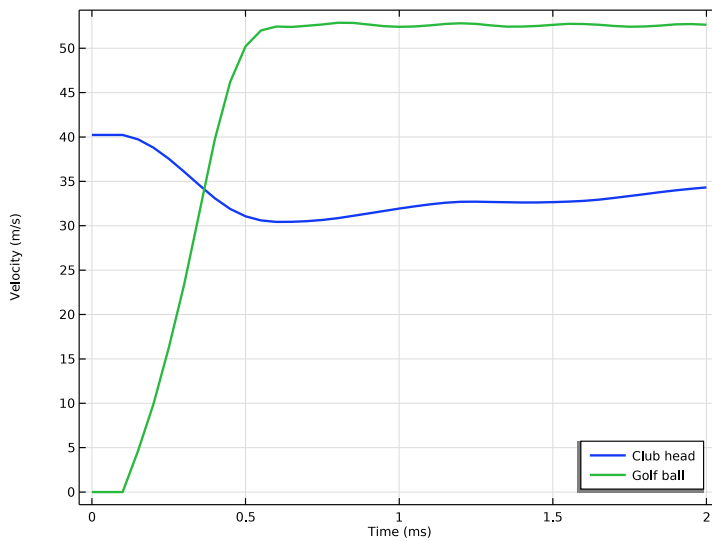

Figure 4: Average magnitude of the velocity in the club head and the golf ball.

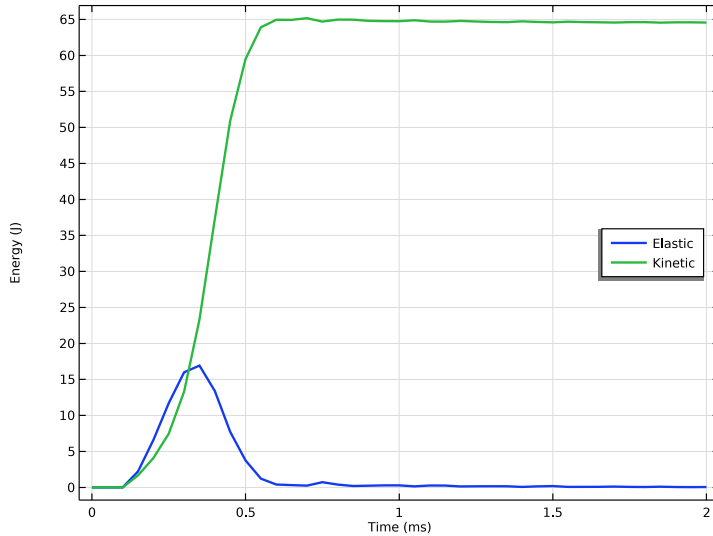

Figure 5: Total elastic and kinetic energy in the golf ball.

Notes About the COMSOL Implementation

The error estimates used by the automatic time-step control will force time steps small enough to resolve the wave propagation within the solid, which is not of primary interest in this analysis. The automatic time-step control will often lead to unnecessarily small time steps, and longer computational time. Therefore, it is often a good practice to use a manual time-step control when the focus is in the kinematics of the contact phenomenon.

The spin rate of the golf ball is determined by adding an **Average Rotation** node to the model. This node makes it possible to compute average rotation for a set of points in a least-squares sense for rotations that are arbitrarily large.

Reference

1. *The Equipment Rules*, 1st edition, The R&A and USGA, 2019.

Application Library path: Nonlinear_Structural_Materials_Module/
Viscoelasticity/golf_ball_impact



Modeling Instructions

From the **File** menu, choose **New**.

NEW

In the **New** window, click  **Model Wizard**.

MODEL WIZARD

- 1 In the **Model Wizard** window, click .
- 2 In the **Select Physics** tree, select **Structural Mechanics > Solid Mechanics (solid)**.
- 3 Click **Add**.
- 4 Click  **Study**.
- 5 In the **Select Study** tree, select **General Studies > Time Dependent**.
- 6 Click  **Done**.

GLOBAL DEFINITIONS



Parameters 1

- 1 In the **Model Builder** window, under **Global Definitions** click **Parameters 1**.
- 2 In the **Settings** window for **Parameters**, locate the **Parameters** section.
- 3 In the table, enter the following settings:

Name	Expression	Value	Description
loft	34[deg]	0.59341 rad	Club head loft
attackAngle	-4.3[deg]	-0.075049 rad	Attack angle
dynLoft	28[deg]	0.48869 rad	Dynamic loft
vel	90[mph]	40.234 m/s	Club head speed
velx	$\cos(\text{attackAngle}) * \text{vel}$	40.12 m/s	Club head velocity, x-component
velz	$\sin(\text{attackAngle}) * \text{vel}$	-3.0167 m/s	Club head velocity, z-component

GEOMETRY I

Import I (impI)



- 1 In the **Geometry** toolbar, click  **Import**.
- 2 In the **Settings** window for **Import**, locate the **Source** section.
- 3 Click  **Browse**.
- 4 Browse to the model's Application Libraries folder and double-click the file `golf_ball_impact.mphbin`.
- 5 Click  **Import**.

Rotate the golf club to the correct dynamic loft at impact.

Rotate I (rotI)

- 1 In the **Geometry** toolbar, click  **Transforms** and choose **Rotate**.
- 2 Select the object **impI(1)** only.
- 3 In the **Settings** window for **Rotate**, locate the **Rotation** section.
- 4 From the **Axis type** list, choose **y-axis**.
- 5 In the **Angle** text field, type `loft-dynLoft`.

Form Union (fin)

- 1 In the **Model Builder** window, under **Component I (compI) > Geometry I** click **Form Union (fin)**.
- 2 In the **Settings** window for **Form Union/Assembly**, locate the **Form Union/Assembly** section.
- 3 From the **Action** list, choose **Form an assembly**.
- 4 In the **Geometry** toolbar, click  **Build All**.
- 5 Click the  **Zoom Extents** button in the **Graphics** toolbar.

Create selections to be used in the physics and plot creation.

DEFINITIONS

Club Head

- 1 In the **Model Builder** window, expand the **Component I (compI) > Definitions** node.
- 2 Right-click **Definitions** and choose **Selections > Explicit**.
- 3 In the **Settings** window for **Explicit**, type `Club Head` in the **Label** text field.
- 4 Select Domains 1 and 2 only.

Club Shaft

- 1 In the **Definitions** toolbar, click  **Explicit**.
- 2 In the **Settings** window for **Explicit**, type Club Shaft in the **Label** text field.
- 3 Select Domains 5, 6, 8–12, and 14 only.

Club Head and Shaft, Boundary

- 1 In the **Definitions** toolbar, click  **Adjacent**.
- 2 In the **Settings** window for **Adjacent**, type Club Head and Shaft, Boundary in the **Label** text field.
- 3 Locate the **Input Entities** section. Under **Input selections**, click **+ Add**.
- 4 In the **Add** dialog, in the **Input selections** list, choose **Club Head** and **Club Shaft**.
- 5 Click **OK**.

Club Ferrule

- 1 In the **Definitions** toolbar, click  **Explicit**.
- 2 In the **Settings** window for **Explicit**, type Club Ferrule in the **Label** text field.
- 3 Select Domains 3, 4, 7, and 13 only.

Club Ferrule, Boundary

- 1 In the **Definitions** toolbar, click  **Adjacent**.
- 2 In the **Settings** window for **Adjacent**, type Club Ferrule, Boundary in the **Label** text field.
- 3 Locate the **Input Entities** section. Under **Input selections**, click **+ Add**.
- 4 In the **Add** dialog, select **Club Ferrule** in the **Input selections** list.
- 5 Click **OK**.

Club

- 1 In the **Definitions** toolbar, click  **Union**.
- 2 In the **Settings** window for **Union**, type Club in the **Label** text field.
- 3 Locate the **Input Entities** section. Under **Selections to add**, click **+ Add**.
- 4 In the **Add** dialog, in the **Selections to add** list, choose **Club Head**, **Club Shaft**, and **Club Ferrule**.
- 5 Click **OK**.

Golf Ball

- 1 In the **Definitions** toolbar, click  **Explicit**.
- 2 In the **Settings** window for **Explicit**, type Golf Ball in the **Label** text field.

- 3 Click the  **Select Box** button in the **Graphics** toolbar.
- 4 Select Domains 15–38 only.

Cover

- 1 In the **Definitions** toolbar, click  **Explicit**.
- 2 In the **Settings** window for **Explicit**, type **Cover** in the **Label** text field.
- 3 Select Domains 15–18, 27, 28, 33, and 38 only.

Mantle

- 1 In the **Definitions** toolbar, click  **Explicit**.
- 2 In the **Settings** window for **Explicit**, type **Mantle** in the **Label** text field.
- 3 Select Domains 19–22, 29, 30, 34, and 37 only.

Inner Core

- 1 In the **Definitions** toolbar, click  **Difference**.
- 2 In the **Settings** window for **Difference**, type **Inner Core** in the **Label** text field.
- 3 Locate the **Input Entities** section. Under **Selections to add**, click **+ Add**.
- 4 In the **Add** dialog, select **Golf Ball** in the **Selections to add** list.
- 5 Click **OK**.
- 6 In the **Settings** window for **Difference**, locate the **Input Entities** section.
- 7 Under **Selections to subtract**, click **+ Add**.
- 8 In the **Add** dialog, in the **Selections to subtract** list, choose **Cover** and **Mantle**.
- 9 Click **OK**.

Core

- 1 In the **Definitions** toolbar, click  **Union**.
- 2 In the **Settings** window for **Union**, type **Core** in the **Label** text field.
- 3 Locate the **Input Entities** section. Under **Selections to add**, click **+ Add**.
- 4 In the **Add** dialog, in the **Selections to add** list, choose **Mantle** and **Inner Core**.
- 5 Click **OK**.

Club Face



- 1 In the **Definitions** toolbar, click  **Explicit**.
- 2 In the **Settings** window for **Explicit**, locate the **Input Entities** section.
- 3 From the **Geometric entity level** list, choose **Boundary**.
- 4 In the **Label** text field, type **Club Face**.

5 Select Boundary 5 only.



Grooves

- 1 In the **Definitions** toolbar, click  **Explicit**.
- 2 In the **Settings** window for **Explicit**, type Grooves in the **Label** text field.
- 3 Locate the **Input Entities** section. From the **Geometric entity level** list, choose **Boundary**.
- 4 Select Boundaries 8–32, 34–48, 50–53, 55, 59–63, 70–73, 75, 86–89, 98, 105–108, and 110 only.

Polished Steel

- 1 In the **Definitions** toolbar, click  **Difference**.
- 2 In the **Settings** window for **Difference**, type Polished Steel in the **Label** text field.
- 3 Locate the **Geometric Entity Level** section. From the **Level** list, choose **Boundary**.
- 4 Locate the **Input Entities** section. Under **Selections to add**, click  **Add**.
- 5 In the **Add** dialog, select **Club Head and Shaft, Boundary** in the **Selections to add** list.
- 6 Click **OK**.
- 7 In the **Settings** window for **Difference**, locate the **Input Entities** section.
- 8 Under **Selections to subtract**, click  **Add**.
- 9 In the **Add** dialog, in the **Selections to subtract** list, choose **Club Face** and **Grooves**.
- 10 Click **OK**.

Contact Pair 1 (p1)

- 1 In the **Definitions** toolbar, click  **Pairs** and choose **Contact Pair**.
- 2 In the **Settings** window for **Pair**, locate the **Source Boundaries** section.
- 3 From the **Selection** list, choose **Club Face**.
- 4 Locate the **Destination Boundaries** section. Click to select the  **Activate Selection** toggle button.
- 5 Select Boundaries 136, 137, 139, and 141 only.

Integration 1 (intop1)

- 1 In the **Definitions** toolbar, click  **Nonlocal Couplings** and choose **Integration**.
- 2 In the **Settings** window for **Integration**, locate the **Source Selection** section.
- 3 From the **Selection** list, choose **Golf Ball**.
- 4 Locate the **Advanced** section. From the **Frame** list, choose **Material (X, Y, Z)**.

Average 1 (aveop1)

- 1 In the **Definitions** toolbar, click  **Nonlocal Couplings** and choose **Average**.
- 2 In the **Settings** window for **Average**, locate the **Source Selection** section.
- 3 From the **Selection** list, choose **Club Head**.
- 4 Locate the **Advanced** section. From the **Frame** list, choose **Material (X, Y, Z)**.

Average 2 (aveop2)

- 1 In the **Definitions** toolbar, click  **Nonlocal Couplings** and choose **Average**.
- 2 In the **Settings** window for **Average**, locate the **Source Selection** section.
- 3 From the **Selection** list, choose **Golf Ball**.
- 4 Locate the **Advanced** section. From the **Frame** list, choose **Material (X, Y, Z)**.

SOLID MECHANICS (SOLID)

Use a linear displacement field and a reduced integration scheme for the golf ball.

- 1 In the **Model Builder** window, under **Component 1 (comp1)** click **Solid Mechanics (solid)**.
- 2 In the **Settings** window for **Solid Mechanics**, click to expand the **Discretization** section.
- 3 From the **Displacement field** list, choose **Linear**.

Hyperelastic Material 1

- 1 In the **Physics** toolbar, click  **Domains** and choose **Hyperelastic Material**.
- 2 In the **Settings** window for **Hyperelastic Material**, locate the **Domain Selection** section.
- 3 From the **Selection** list, choose **Cover**.
- 4 Locate the **Quadrature Settings** section. Select the **Reduced integration** checkbox.

Hyperelastic Material 2

- 1 In the **Physics** toolbar, click  **Domains** and choose **Hyperelastic Material**.
- 2 In the **Settings** window for **Hyperelastic Material**, locate the **Domain Selection** section.
- 3 From the **Selection** list, choose **Core**.
- 4 Locate the **Hyperelastic Material** section. From the **Compressibility** list, choose **Nearly incompressible**.
- 5 From the **Volumetric strain energy** list, choose **Hartmann–Neff**.
- 6 In the κ text field, type 1 [GPa].
- 7 Locate the **Quadrature Settings** section. Select the **Reduced integration** checkbox.

Viscoelasticity 1

- 1 In the **Physics** toolbar, click  **Attributes** and choose **Viscoelasticity**.

- 2 In the **Settings** window for **Viscoelasticity**, locate the **Viscoelasticity Model** section.
- 3 Click **+ Add**.
- 4 Click **+ Add**.
- 5 In the table, enter the following settings:

Branch	Energy factor (I)	Relaxation time (s)
1	0.26	1e-5
2	0.19	1e-4
3	0.22	1e-3

Contact 1

- 1 In the **Model Builder** window, under **Component 1 (comp1) > Solid Mechanics (solid)** click **Contact 1**.
- 2 In the **Settings** window for **Contact**, locate the **Contact Method** section.
- 3 From the list, choose **Penalty, dynamic**.
- 4 Locate the **Contact Pressure Penalty Factor** section. From the **Penalty factor control** list, choose **Viscous only**.
- 5 In the τ_n text field, type 0.1 [ms].

Friction 1

- 1 In the **Physics** toolbar, click  **Attributes** and choose **Friction**.
- 2 In the **Settings** window for **Friction**, locate the **Friction Parameters** section.
- 3 In the μ text field, type 0.15.

Initial Values 2

- 1 In the **Physics** toolbar, click  **Domains** and choose **Initial Values**.
- 2 In the **Settings** window for **Initial Values**, locate the **Domain Selection** section.
- 3 From the **Selection** list, choose **Club**.
- 4 Specify the du/dt vector as
- 5 In the table, enter the following settings:

velx	X
0	Y
velz	Z

Prescribed Displacement 1

- 1 In the **Physics** toolbar, click  **Boundaries** and choose **Prescribed Displacement**.

- 2 Select Boundaries 131, 132, 134, and 135 only.
- 3 In the **Settings** window for **Prescribed Displacement**, locate the **Prescribed Displacement** section.
- 4 From the **Displacement in x direction** list, choose **Prescribed**.
- 5 From the **Displacement in y direction** list, choose **Prescribed**.
- 6 From the **Displacement in z direction** list, choose **Prescribed**.
- 7 In the u_{0x} text field, type $velx*t$.
- 8 In the u_{0z} text field, type $velz*t$.

Add an **Average Rotation** node to compute typical golf metrics.

Average Rotation 1

- 1 In the **Physics** toolbar, click  **Global** and choose **Average Rotation**.
- 2 Select Points 158, 161, 164, 166, 169, and 172 only.
- 3 In the **Settings** window for **Average Rotation**, locate the **Center of Rotation** section.
- 4 From the list, choose **Centroid of selected entities**.
- 5 From the **Entity level** list, choose **Point**.
- 6 Locate the **Rotation Model** section. From the list, choose **Finite rotations, symmetric segregated**.

Center of Rotation: Point 1

- 1 In the **Model Builder** window, click **Center of Rotation: Point 1**.
- 2 Select Point 165 only.

MATERIALS

Club Head

- 1 In the **Model Builder** window, under **Component 1 (comp1)** right-click **Materials** and choose **Blank Material**.
- 2 In the **Settings** window for **Material**, type Club Head in the **Label** text field.
- 3 Locate the **Geometric Entity Selection** section. From the **Selection** list, choose **Club**.

4 Locate the **Material Contents** section. In the table, enter the following settings:

Property	Variable	Value	Unit	Property group
Young's modulus	E	200e9	Pa	Young's modulus and Poisson's ratio
Poisson's ratio	nu	0.3	I	Young's modulus and Poisson's ratio
Density	rho	7850	kg/m ³	Basic

Set material appearance data for use in plot creation.

5 Click to expand the **Appearance** section. From the **Material type** list, choose **Steel**.

Cover

1 Right-click **Materials** and choose **Blank Material**.

2 In the **Settings** window for **Material**, type Cover in the **Label** text field.

3 Locate the **Geometric Entity Selection** section. From the **Selection** list, choose **Cover**.

4 Locate the **Material Contents** section. In the table, enter the following settings:

Property	Variable	Value	Unit	Property group
Lamé parameter λ	lamLame	1.5e9	N/m ²	Lamé parameters
Lamé parameter μ	muLame	0.2e9	N/m ²	Lamé parameters
Density	rho	1145	kg/m ³	Basic

Mantle

1 Right-click **Materials** and choose **Blank Material**.

2 In the **Settings** window for **Material**, type Mantle in the **Label** text field.

3 Locate the **Geometric Entity Selection** section. From the **Selection** list, choose **Mantle**.

4 Locate the **Material Contents** section. In the table, enter the following settings:

Property	Variable	Value	Unit	Property group
Lamé parameter μ	muLame	6e6	N/m ²	Lamé parameters
Density	rho	1145	kg/m ³	Basic

5 Click to expand the **Appearance** section. From the **Color** list, choose **Blue**.

Inner Core

1 Right-click **Materials** and choose **Blank Material**.

2 In the **Settings** window for **Material**, type Inner Core in the **Label** text field.

- 3 Locate the **Geometric Entity Selection** section. From the **Selection** list, choose **Inner Core**.
- 4 Locate the **Material Contents** section. In the table, enter the following settings:

Property	Variable	Value	Unit	Property group
Lamé parameter μ	muLame	12e6	N/m ²	Lamé parameters
Density	rho	1145	kg/m ³	Basic

- 5 Click to expand the **Appearance** section. From the **Color** list, choose **Magenta**.

MESH I

- 1 In the **Model Builder** window, under **Component 1 (comp1)** click **Mesh I**.
- 2 In the **Settings** window for **Mesh**, locate the **Physics-Controlled Mesh** section.
- 3 In the table, clear the **Use** checkbox for **Geometric Analysis, Detail Size**.
- 4 Locate the **Sequence Type** section. From the list, choose **User-controlled mesh**.

Size

- 1 In the **Model Builder** window, under **Component 1 (comp1) > Mesh I** click **Size**.
- 2 In the **Settings** window for **Size**, locate the **Element Size** section.
- 3 Click the **Custom** button.
- 4 Locate the **Element Size Parameters** section. In the **Maximum element size** text field, type 0.01.
- 5 In the **Minimum element size** text field, type 0.001.
- 6 In the **Maximum element growth rate** text field, type 1.4.
- 7 In the **Curvature factor** text field, type 0.2.
- 8 In the **Resolution of narrow regions** text field, type 0.8.

Mapped I

- 1 In the **Mesh** toolbar, click  **More Generators** and choose **Mapped**.
- 2 Select Boundaries 84, 85, 109, 128, 131, 132, 134, and 135 only.

Distribution I

- 1 Right-click **Mapped I** and choose **Distribution**.
- 2 Select Edges 168, 169, 203, 240, 244, 245, 254, and 258 only.
- 3 In the **Settings** window for **Distribution**, locate the **Distribution** section.
- 4 In the **Number of elements** text field, type 3.

Swept 1

- 1 In the **Mesh** toolbar, click  **Swept**.
- 2 In the **Settings** window for **Swept**, locate the **Domain Selection** section.
- 3 From the **Geometric entity level** list, choose **Domain**.
- 4 Select Domains 3–14 only.

Free Quad 1

- 1 In the **Mesh** toolbar, click  **More Generators** and choose **Free Quad**.
- 2 Select Boundary 83 only.

Swept 2

- 1 In the **Mesh** toolbar, click  **Swept**.
- 2 In the **Settings** window for **Swept**, locate the **Domain Selection** section.
- 3 From the **Geometric entity level** list, choose **Domain**.
- 4 Select Domain 2 only.

Free Tetrahedral 1

- 1 In the **Model Builder** window, click **Free Tetrahedral 1**.
- 2 Drag and drop below **Swept 2**.
- 3 In the **Settings** window for **Free Tetrahedral**, click  **Build All**.

STUDY 1

Step 1: Time Dependent

- 1 In the **Model Builder** window, under **Study 1** click **Step 1: Time Dependent**.
- 2 In the **Settings** window for **Time Dependent**, locate the **Study Settings** section.
- 3 In the **Output times** text field, type $2e-3$.

Modify the time-dependent solver to use a manual time step control.

Solution 1 (sol1)

- 1 In the **Study** toolbar, click  **Show Default Solver**.
- 2 In the **Model Builder** window, expand the **Solution 1 (sol1)** node, then click **Time-Dependent Solver 1**.
- 3 In the **Settings** window for **Time-Dependent Solver**, locate the **General** section.
- 4 From the **Times to store** list, choose **Steps taken by solver**.
- 5 In the **Store every Nth step** text field, type 2.

- 6 Click to expand the **Time Stepping** section. From the **Steps taken by solver** list, choose **Manual**.
- 7 In the **Time step** text field, type 2.5e-5.
Increase the number of allowed nonlinear iterations and use a stricter tolerance.
- 8 In the **Model Builder** window, expand the **Study 1 > Solver Configurations > Solution 1 (sol1) > Time-Dependent Solver 1** node, then click **Fully Coupled 1**.
- 9 In the **Settings** window for **Fully Coupled**, click to expand the **Method and Termination** section.
- 10 In the **Maximum number of iterations** text field, type 25.
- 11 In the **Tolerance factor** text field, type 0.1.
Generate datasets and default plots.
- 12 In the **Study** toolbar, click  **Get Initial Value**.

RESULTS

Strain (solid)

- 1 In the **Settings** window for **3D Plot Group**, type **Strain (solid)** in the **Label** text field.
- 2 Click to expand the **Selection** section. From the **Geometric entity level** list, choose **Domain**.
- 3 Select Domains 17, 18, 21, 22, 25, 26, and 33–38 only.

Volume 1

- 1 In the **Model Builder** window, expand the **Strain (solid)** node, then click **Volume 1**.
- 2 In the **Settings** window for **Volume**, locate the **Expression** section.
- 3 In the **Expression** text field, type **solid.ep3**.
- 4 Locate the **Coloring and Style** section. From the **Color table** list, choose **RainbowLight**.
- 5 From the **Color table transformation** list, choose **Reverse**.
- 6 Click to expand the **Quality** section. From the **Evaluation settings** list, choose **Manual**.
- 7 From the **Smoothing** list, choose **Everywhere**.
- 8 From the **Smoothing threshold** list, choose **None**.

Volume 2

- 1 Right-click **Results > Strain (solid) > Volume 1** and choose **Duplicate**.
- 2 In the **Settings** window for **Volume**, click to expand the **Title** section.
- 3 From the **Title type** list, choose **None**.

Material Appearance 1

- 1 Right-click **Volume 2** and choose **Material Appearance**.
- 2 In the **Strain (solid)** toolbar, click  **Plot**.

STUDY 1

Step 1: Time Dependent

- 1 In the **Model Builder** window, under **Study 1** click **Step 1: Time Dependent**.
- 2 In the **Settings** window for **Time Dependent**, click to expand the **Results While Solving** section.
- 3 Select the **Plot** checkbox.
- 4 From the **Update at** list, choose **Time steps taken by solver**.
- 5 In the **Study** toolbar, click  **Compute**.

Create a material rendering plot and make an animation.

RESULTS

Material Rendering

- 1 In the **Results** toolbar, click  **3D Plot Group**.
- 2 In the **Settings** window for **3D Plot Group**, type **Material Rendering** in the **Label** text field.
- 3 Locate the **Plot Settings** section. Clear the **Plot dataset edges** checkbox.

Golf Ball

- 1 Right-click **Material Rendering** and choose **Surface**.
- 2 In the **Settings** window for **Surface**, type **Golf Ball** in the **Label** text field.
- 3 Locate the **Expression** section. In the **Expression** text field, type **1**.
- 4 Click to expand the **Title** section. From the **Title type** list, choose **None**.

Deformation 1

- 1 Right-click **Golf Ball** and choose **Deformation**.
- 2 In the **Settings** window for **Deformation**, locate the **Scale** section.
- 3 Select the **Scale factor** checkbox. In the associated text field, type **1**.

Selection 1

- 1 In the **Model Builder** window, right-click **Golf Ball** and choose **Selection**.
- 2 Select Boundaries 136, 137, 161, and 163 only.

Image 1

- 1 Right-click **Golf Ball** and choose **Image**.
- 2 In the **Settings** window for **Image**, locate the **File** section.
- 3 Click  **Browse**.
- 4 Browse to the model's Application Libraries folder and double-click the file `golf_ball_impact_logo.png`.
- 5 Locate the **Mapping** section. From the **Mapping** list, choose **Planar**.
- 6 From the **Plane type** list, choose **xz-plane**.
- 7 Find the **Size** subsection. In the **Width** text field, type 0.03.
- 8 Find the **Anchor point** subsection. In the **X** text field, type -0.015.
- 9 In the **Y** text field, type -0.03.
- 10 In the **Z** text field, type -0.002.
- 11 Find the **Tiling** subsection. From the **Extrapolation** list, choose **Clamp to edge**.

Material Appearance 1

- 1 Right-click **Golf Ball** and choose **Material Appearance**.
- 2 In the **Settings** window for **Material Appearance**, locate the **Appearance** section.
- 3 From the **Material** list, choose **Cover (mat2)**.
- 4 Locate the **Color** section. Select the **Use the image's color** checkbox.

Golf Ball 1

- 1 Right-click **Golf Ball** and choose **Duplicate**.
- 2 In the **Settings** window for **Surface**, click to expand the **Inherit Style** section.
- 3 From the **Plot** list, choose **Golf Ball**.

Selection 1



- 1 In the **Model Builder** window, expand the **Golf Ball 1** node, then click **Selection 1**.
- 2 In the **Settings** window for **Selection**, locate the **Selection** section.
- 3 Click to select the  **Activate Selection** toggle button.
- 4 Select Boundaries 139, 141, 177, and 193 only.

Image 1

- 1 In the **Model Builder** window, click **Image 1**.
- 2 In the **Settings** window for **Image**, locate the **Mapping** section.
- 3 From the **Plane type** list, choose **xz-plane**.

- 4 Find the **Anchor point** subsection. In the **Y** text field, type 0.03.
- 5 In the **X** text field, type 0.015.
- 6 In the **Material Rendering** toolbar, click  **Plot**.

Club Head

- 1 In the **Model Builder** window, right-click **Golf Ball** and choose **Duplicate**.
- 2 In the **Settings** window for **Surface**, type Club Head in the **Label** text field.
- 3 Locate the **Inherit Style** section. From the **Plot** list, choose **Golf Ball**.

Selection 1

- 1 In the **Model Builder** window, expand the **Club Head** node, then click **Selection 1**.
- 2 In the **Settings** window for **Selection**, locate the **Selection** section.
- 3 From the **Selection** list, choose **Polished Steel**.

Image 1

In the **Model Builder** window, right-click **Image 1** and choose **Delete**.

Material Appearance 1

- 1 In the **Settings** window for **Material Appearance**, locate the **Appearance** section.
- 2 From the **Material** list, choose **Club Head (mat1)**.
- 3 Locate the **Color** section. Clear the **Use the plot's color** checkbox.

Club Face

- 1 In the **Model Builder** window, right-click **Club Head** and choose **Duplicate**.
- 2 In the **Settings** window for **Surface**, type Club Face in the **Label** text field.

Selection 1

- 1 In the **Model Builder** window, expand the **Club Face** node, then click **Selection 1**.
- 2 In the **Settings** window for **Selection**, locate the **Selection** section.
- 3 From the **Selection** list, choose **Club Face**.

Material Appearance 1

- 1 In the **Model Builder** window, click **Material Appearance 1**.
- 2 In the **Settings** window for **Material Appearance**, locate the **Appearance** section.
- 3 From the **Appearance** list, choose **Custom**.
- 4 From the **Material type** list, choose **Steel (scratched)**.

Grooves

- 1 In the **Model Builder** window, right-click **Club Face** and choose **Duplicate**.

- 2 In the **Model Builder** window, click **Club Face 1**.
- 3 In the **Settings** window for **Surface**, type Grooves in the **Label** text field.

Material Appearance 1

- 1 In the **Model Builder** window, click **Material Appearance 1**.
- 2 In the **Settings** window for **Material Appearance**, locate the **Appearance** section.
- 3 From the **Material type** list, choose **Plastic**.
- 4 From the **Color** list, choose **Black**.







Selection 1

- 1 In the **Model Builder** window, click **Selection 1**.
- 2 In the **Settings** window for **Selection**, locate the **Selection** section.
- 3 From the **Selection** list, choose **Grooves**.

Ferrule

- 1 In the **Model Builder** window, right-click **Grooves** and choose **Duplicate**.
- 2 In the **Settings** window for **Surface**, type Ferrule in the **Label** text field.

Selection 1

- 1 In the **Model Builder** window, expand the **Ferrule** node, then click **Selection 1**.
- 2 In the **Settings** window for **Selection**, locate the **Selection** section.
- 3 From the **Selection** list, choose **Club Ferrule, Boundary**.
- 4 In the **Graphics** window toolbar, click  next to  **Scene Light**, then choose **Ambient Occlusion**.
- 5 In the **Graphics** window toolbar, click  next to  **Scene Light**, then choose **Floor Shadows**.
- 6 In the **Graphics** window toolbar, click  next to  **Scene Light**, then choose **Outdoor**.

Animation 1

- 1 In the **Material Rendering** toolbar, click  **Animation** and choose **Player**.
- 2 In the **Settings** window for **Animation**, locate the **Frames** section.
- 3 From the **Frame selection** list, choose **All**.

Energy

- 1 In the **Results** toolbar, click  **ID Plot Group**.
- 2 In the **Settings** window for **ID Plot Group**, type Energy in the **Label** text field.
- 3 Click to expand the **Title** section. From the **Title type** list, choose **None**.

- 4 Locate the **Plot Settings** section.
- 5 Select the **y-axis label** checkbox. In the associated text field, type Energy (J).
- 6 Locate the **Legend** section. From the **Position** list, choose **Middle right**.

Global I

- 1 Right-click **Energy** and choose **Global**.
- 2 In the **Settings** window for **Global**, locate the **y-Axis Data** section.
- 3 In the table, enter the following settings:

Expression	Unit	Description
intop1(solid.Ws)		Elastic
intop1(solid.Wk)		Kinetic

- 4 Locate the **x-Axis Data** section. From the **Unit** list, choose **ms**.
- 5 Click to expand the **Coloring and Style** section. From the **Width** list, choose **2**.
- 6 In the **Energy** toolbar, click  **Plot**.

Velocity

- 1 In the **Results** toolbar, click  **ID Plot Group**.
- 2 In the **Settings** window for **ID Plot Group**, type Velocity in the **Label** text field.
- 3 Locate the **Title** section. From the **Title type** list, choose **None**.
- 4 Locate the **Plot Settings** section.
- 5 Select the **y-axis label** checkbox. In the associated text field, type Velocity (m/s).
- 6 Locate the **Legend** section. From the **Position** list, choose **Lower right**.

Global I

- 1 Right-click **Velocity** and choose **Global**.
- 2 In the **Settings** window for **Global**, locate the **y-Axis Data** section.
- 3 In the table, enter the following settings:

Expression	Unit	Description
aveop1(solid.vel)	m/s	Club head
aveop2(solid.vel)	m/s	Golf ball

- 4 Locate the **x-Axis Data** section. From the **Unit** list, choose **ms**.
- 5 Locate the **Coloring and Style** section. From the **Width** list, choose **2**.
- 6 In the **Velocity** toolbar, click  **Plot**.

Evaluate typical golf metrics.

Golf Metrics

- 1 In the **Results** toolbar, click  **Evaluation Group**.
- 2 In the **Settings** window for **Evaluation Group**, type Golf Metrics in the **Label** text field.
- 3 Locate the **Data** section. From the **Time selection** list, choose **Last**.

Point Evaluation 1

- 1 Right-click **Golf Metrics** and choose **Point Evaluation**.
- 2 Select Point 165 only.
- 3 In the **Settings** window for **Point Evaluation**, locate the **Expressions** section.
- 4 In the table, enter the following settings:

Expression	Unit	Description
$\text{atan}(z/x)$	deg	Launch angle

Global Evaluation 1

- 1 In the **Model Builder** window, right-click **Golf Metrics** and choose **Global Evaluation**.
- 2 In the **Settings** window for **Global Evaluation**, locate the **Expressions** section.
- 3 In the table, enter the following settings:

Expression	Unit	Description
$\text{solid.avgr1.disp}_t$	mph	Ball speed
$\text{solid.avgr1.disp}_t/\text{vel}$	1	Smash factor
$\text{solid.avgr1.totrot}_t/(2*\text{pi}[\text{rad}])$	rpm	Spin rate

- 4 In the **Golf Metrics** toolbar, click  **Evaluate**.

Finally, set up the plot to use for the model thumbnail.

Strain (solid)

- 1 In the **Model Builder** window, under **Results** click **Strain (solid)**.
- 2 In the **Settings** window for **3D Plot Group**, locate the **Data** section.
- 3 From the **Time (s)** list, choose **3E-4**.
- 4 Locate the **Plot Settings** section. From the **View** list, choose **New view**.
- 5 In the **Strain (solid)** toolbar, click  **Plot**.
- 6 Click to expand the **Title** section. From the **Title type** list, choose **Custom**.
- 7 Find the **Type and data** subsection. Clear the **Type** checkbox.

- 8 Clear the **Unit** checkbox.
- 9 Clear the **Description** checkbox.
- 10 In the **Strain (solid)** toolbar, click  **Plot**.