



Model created in COMSOL Multiphysics 6.4

# Shell Diffusion in a Tank

## Introduction

---

A goal for many applications is to predict physics in thin structures, such as shells, without modeling the thickness of the structure. This is because large aspect ratios can cause meshing and geometry analysis problems. The model reported here demonstrates how to use the *tangential derivative variables* in COMSOL Multiphysics to solve partial differential equations in curved 3D shells and 2D boundaries without modeling their thickness.

## Model Definition

---

The steel tank shown below has two pipe connections. One is grounded and the other connects to a dead current source. This model calculates the current density in the tank shell along with the potential distribution across the surface.

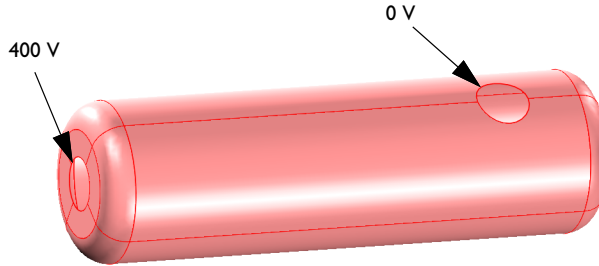

### EQUATIONS

The fundamental equation to solve is the current conduction, or charge conservation, equation.

$$\nabla \cdot (-\sigma \nabla V) = 0 \quad (1)$$

Here,  $\sigma$  is the electrical conductivity (S/m) and  $V$  is the electric potential (V).

The material is a 1 mm thick steel sheet with a conductivity of  $4.032 \cdot 10^6$  S/m. You are working with a surface in 3D so there is no thickness in the model. To account for the charge conservation in [Equation 1](#) you must multiply the current flux expression with the shell thickness  $d$ :

$$\nabla \cdot (-\sigma d \nabla V) = 0 \quad (2)$$

## Results

Figure 1 shows the potential distribution across the surface.

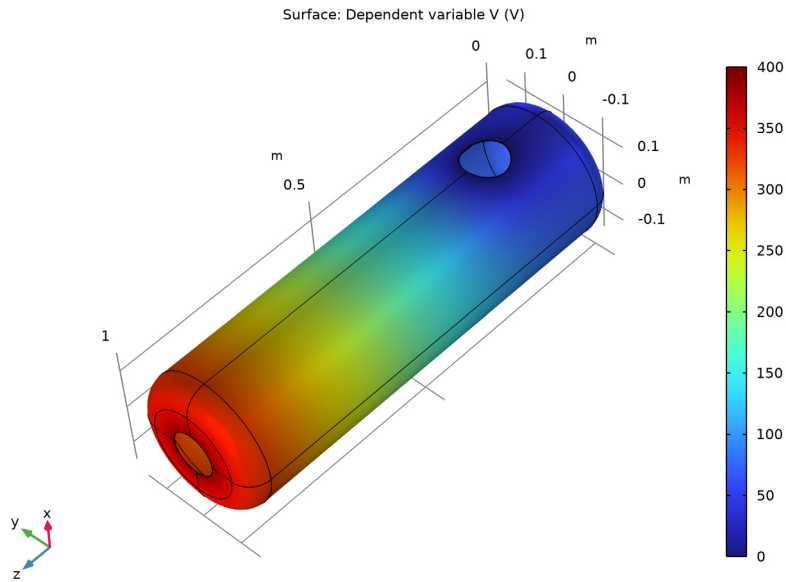

Figure 1: Electric potential distribution across the surface (V).

Figure 2 adds the current field as an arrow plot, showing clearly how the current collects toward the grounded connection.

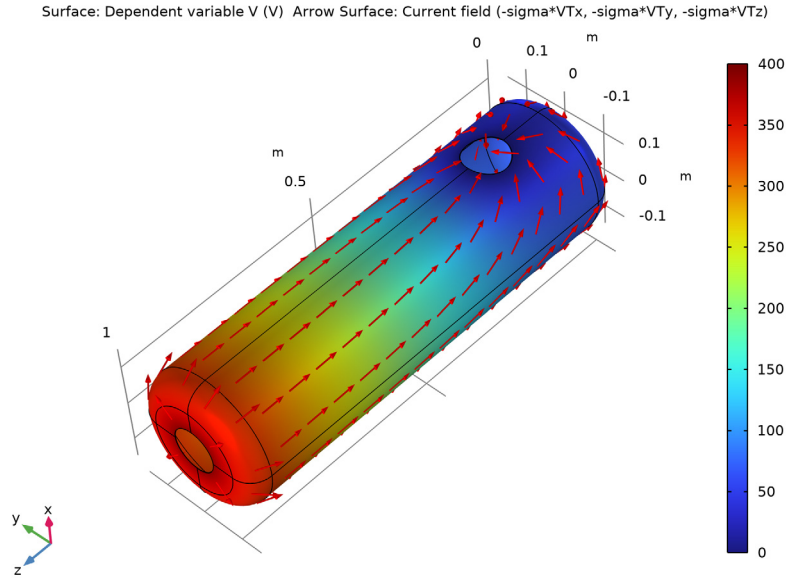

Figure 2: Arrow plot of the local current field.

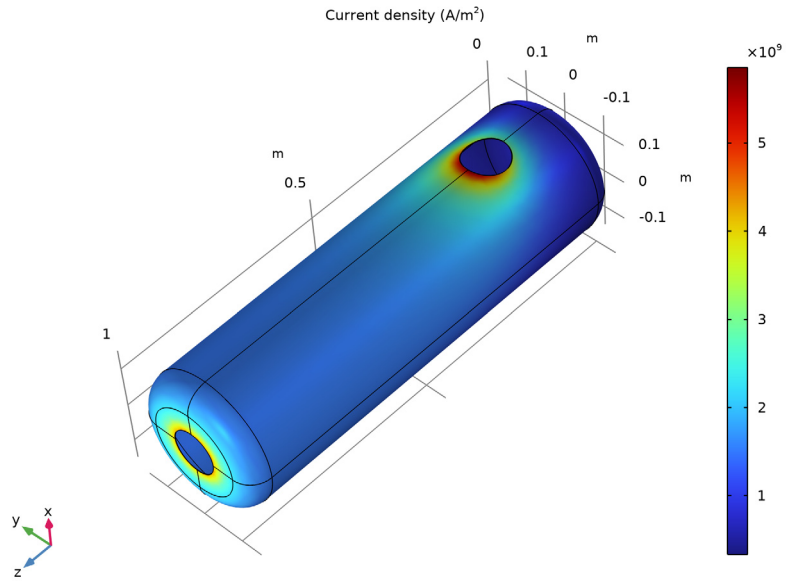

Figure 3: Local magnitude of the electric current density ( $A/m^2$ ).

The plot of the magnitude of the local current density in [Figure 3](#) is interesting because you can use it to calculate the resistive heating in the material as an extension to the model.

### *Notes About the COMSOL Implementation*

---

Model [Equation 2](#), the current conduction equation, using a Coefficient Form Boundary PDE interface, setting the diffusion coefficient  $c = \sigma d$ . To define the current field components use tangential derivative variables, which you access in COMSOL Multiphysics by adding a T suffix to the variable name before specifying the gradient component. So, for example, the tangential derivative  $(\partial u / \partial x)_T$  is represented by the variable `uTx`.

---

**Application Library path:** `COMSOL_Multiphysics/Equation_Based/shell_diffusion`

---

### *Modeling Instructions*

---



From the **File** menu, choose **New**.

#### **NEW**

In the **New** window, click  **Model Wizard**.

#### **MODEL WIZARD**

- 1** In the **Model Wizard** window, click  **3D**.
- 2** In the **Select Physics** tree, select **Mathematics > PDE Interfaces > Lower Dimensions > Coefficient Form Boundary PDE (cb)**.
- 3** Click **Add**.
- 4** In the **Dependent variables (1)** table, enter the following settings:  

|     |
|-----|
| $v$ |
|-----|
- 5** Click  **Study**.
- 6** In the **Select Study** tree, select **General Studies > Stationary**.
- 7** Click  **Done**.

## GLOBAL DEFINITIONS



### Parameters 1

- 1 In the **Model Builder** window, under **Global Definitions** click **Parameters 1**.
- 2 In the **Settings** window for **Parameters**, locate the **Parameters** section.
- 3 In the table, enter the following settings:

| Name  | Expression   | Value       | Description     |
|-------|--------------|-------------|-----------------|
| sigma | 4.032e6[S/m] | 4.032E6 S/m | Conductivity    |
| d     | 1 [mm]       | 0.001 m     | Shell thickness |

## GEOMETRY 1

Create the geometry. To simplify this step, insert a prepared geometry sequence.

- 1 In the **Geometry** toolbar, click **Insert Sequence** and choose **Insert Sequence**.
- 2 Browse to the model's Application Libraries folder and double-click the file `shell_diffusion_geom_sequence.mph`.
- 3 In the **Geometry** toolbar, click  **Build All**.
- 4 Click the  **Zoom Extents** button in the **Graphics** toolbar.

## COEFFICIENT FORM BOUNDARY PDE (CB)

- 1 In the **Model Builder** window, under **Component 1 (comp1)** click **Coefficient Form Boundary PDE (cb)**.
- 2 In the **Settings** window for **Coefficient Form Boundary PDE**, locate the **Units** section.
- 3 Click  **Select Dependent Variable Quantity**.
- 4 In the **Physical Quantity** dialog, type `electricpotential` in the text field.
- 5 In the tree, select **Electromagnetics > Electric potential (V)**.
- 6 Click **OK**.
- 7 In the **Settings** window for **Coefficient Form Boundary PDE**, locate the **Units** section.
- 8 In the **Source term quantity** table, enter the following settings:

| Source term quantity | Unit              |
|----------------------|-------------------|
| Custom unit          | A*m <sup>-2</sup> |

### Coefficient Form PDE 1

- 1 In the **Model Builder** window, under **Component 1 (comp1)** > **Coefficient Form Boundary PDE (cb)** click **Coefficient Form PDE 1**.

- 2 In the **Settings** window for **Coefficient Form PDE**, locate the **Diffusion Coefficient** section.
- 3 In the  $c$  text field, type  $\text{sigma} \cdot d$ .
- 4 Locate the **Source Term** section. In the  $f$  text field, type 0.

These settings specify the charge conservation equation (Equation 2) for the shell surface.

Go on to set the values of the potential at the pipe connections by adding Dirichlet boundary conditions.

#### *Dirichlet Boundary Condition 1*

- 1 In the **Physics** toolbar, click  **Edges** and choose **Dirichlet Boundary Condition**.
- 2 Select Edges 14, 15, 25, and 29 only.
- 3 In the **Settings** window for **Dirichlet Boundary Condition**, locate the **Dirichlet Boundary Condition** section.
- 4 In the  $r$  text field, type 400.

#### *Dirichlet Boundary Condition 2*

- 1 In the **Physics** toolbar, click  **Edges** and choose **Dirichlet Boundary Condition**.
- 2 Select Edges 40–43 only.

## MESH 1

In the **Model Builder** window, under **Component 1 (comp1)** right-click **Mesh 1** and choose **Build All**.

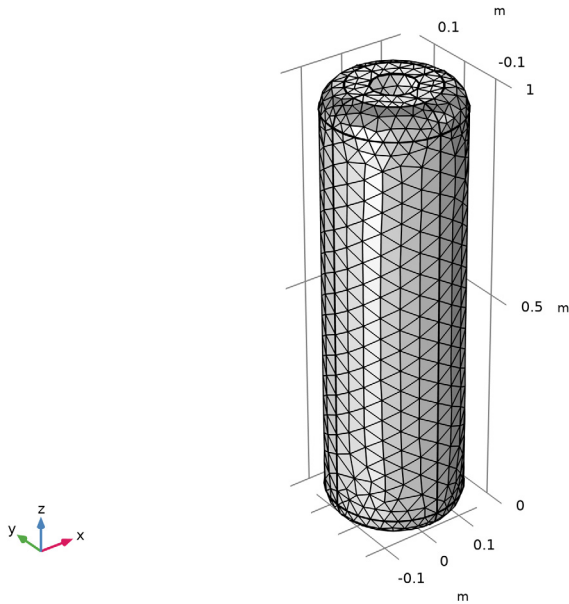

## STUDY 1

In the **Study** toolbar, click  **Compute**.

## RESULTS

### *Coefficient Form Boundary PDE*

The default plot shows the potential distribution.

Rotate the geometry so that you see both pipe connections. Compare the result with the plot in [Figure 1](#).

1 Click the  **Zoom Extents** button in the **Graphics** toolbar.

Add an arrow surface plot of the current field as follows:

### *Arrow Surface 1*

1 Right-click **Coefficient Form Boundary PDE** and choose **Arrow Surface**.

2 In the **Settings** window for **Arrow Surface**, locate the **Expression** section.

3 In the **X-component** text field, type  $-\sigma * VT_x$ .

- 4 In the **Y-component** text field, type  $-\sigma \cdot V_{Ty}$ .
- 5 In the **Z-component** text field, type  $-\sigma \cdot V_{Tz}$ .
- 6 Select the **Description** checkbox. In the associated text field, type Current field ( $-\sigma \cdot V_{Tx}$ ,  $-\sigma \cdot V_{Ty}$ ,  $-\sigma \cdot V_{Tz}$ ).
- 7 Locate the **Coloring and Style** section. From the **Arrow length** list, choose **Normalized**.
- 8 In the **Coefficient Form Boundary PDE** toolbar, click  **Plot**.



The plot in the **Graphics** window should now look like that in [Figure 2](#).

To visualize the magnitude of the local current density, follow the steps given below.

### 3D Plot Group 2

- 1 In the **Results** toolbar, click  **3D Plot Group**.
- 2 In the **Settings** window for **3D Plot Group**, click to expand the **Title** section.
- 3 From the **Title type** list, choose **Manual**.
- 4 In the **Title** text area, type Current density ( $A/m^{sup>2</sup>}$ ).

### Surface 1

- 1 Right-click **3D Plot Group 2** and choose **Surface**.
- 2 In the **Settings** window for **Surface**, locate the **Expression** section.
- 3 In the **Expression** text field, type  $\sigma \cdot \sqrt{V_{Tx}^2 + V_{Ty}^2 + V_{Tz}^2}$ .
- 4 In the **3D Plot Group 2** toolbar, click  **Plot**.
- 5 Click the  **Zoom Extents** button in the **Graphics** toolbar.

