



Model created in COMSOL Multiphysics 6.4

# An Integro-Partial Differential Equation<sup>1</sup>

---

1. This application is courtesy of Daniel Smith and Ali Shajji of MKS Instruments, Wilmington, Mass., USA.

## Introduction

---

This example contains an analysis of conductive and radiative heat transfer in a hollow pipe, where the ends are held at two different temperatures. To solve this integro-partial differential equation, the model makes use of the destination operator and a nonlocal integration coupling.

## Model Definition

---

This example investigates how to solve the integro-partial differential equation

$$\frac{\partial}{\partial x} \left( \kappa \frac{\partial T}{\partial x} \right) - \frac{4D_i}{D_o^2 - D_i^2} \varepsilon \sigma T^4 + \frac{4D_i}{D_o^2 - D_i^2} \varepsilon \sigma \int_0^L k(x, x') T(x')^4 \cdot \frac{dx'}{D_i} = \rho C_p \frac{\partial T}{\partial t} \quad (1)$$

where  $L$  is the pipe length,  $D_i$  and  $D_o$  are respectively the inner and outer diameters of the pipe,  $\rho$  is the density,  $C_p$  is the heat capacity,  $\kappa$  is the thermal conductivity,  $\sigma$  is Stefan's constant (the Stefan-Boltzmann constant),  $\varepsilon$  is the emissivity, and  $k(x, x')$  is the kernel corresponding to the radiation view factor. This equation arises in the physical description of 1D heat conduction and radiation along a pipe. [Figure 1](#) shows the model geometry.

Before setting up the model, make the following assumptions:

- Inside the tube, neglect convection and consider only radiation and conduction.
- Assume blackbody radiation with  $\varepsilon = 1$ .
- Model heat transfer only in the  $x$  direction (assume  $\theta$  symmetry).
- The pipe's outer wall is perfectly insulated so that no heat escapes to the outside world by either radiation or conduction.

The definition of the kernel  $k(x, x')$  is

$$1 - \frac{2\xi^3 + 3\xi}{2(\xi^2 + 1)^{3/2}}$$

where  $\xi = |x - x'|/D_i$  as explained in [Ref. 1](#).

Also consider the following boundary conditions and initial condition:

$$\begin{aligned} T(0, t) &= 300 + 1200 \tanh\left(\frac{t}{1 \text{ min}}\right) \text{ K} \\ T(L, t) &= 300 \text{ K} \\ T(x, 0) &= 300 \text{ K} \end{aligned}$$

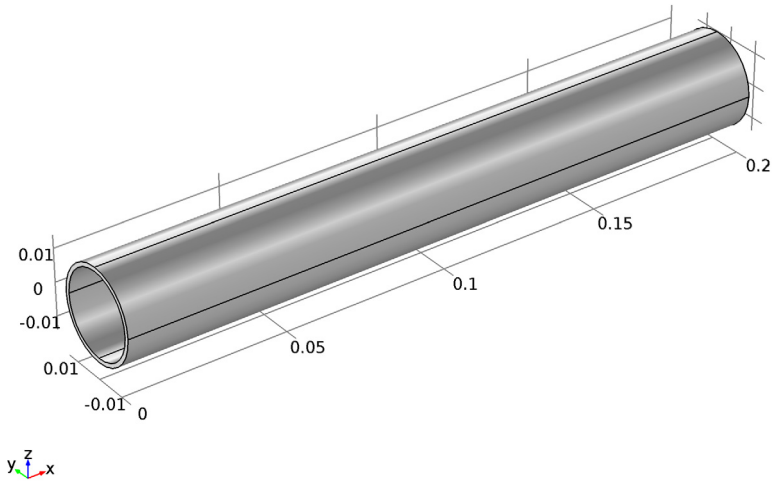

*Figure 1: Model geometry.*

### *Results and Discussion*

---

The temperature distribution along the length of the pipe at  $t = 3600$  s appears in [Figure 2](#). The straight line is the solution for the radiation-free model obtained by setting the emissivity to zero:

$$\frac{\partial}{\partial x} \left( \kappa \frac{\partial T}{\partial x} \right) = \rho C_p \frac{\partial T}{\partial t}$$

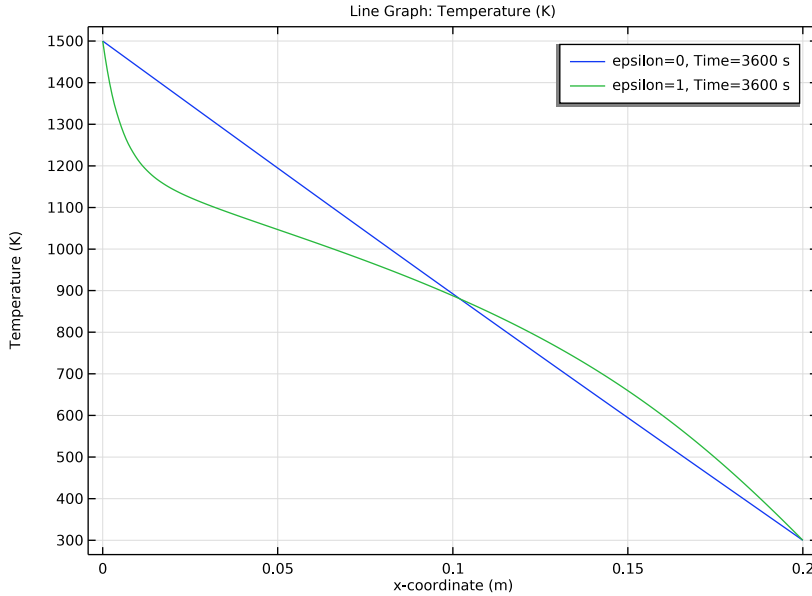

Figure 2: Temperature distribution along the pipe at  $t = 3600$  s with radiation ( $\epsilon = 1$ ) and without radiation ( $\epsilon = 0$ ).

#### COMPARISON WITH THE FULL 3D RADIATION MODEL

To illustrate the validity of the 1D model, you can set up the entire stationary 3D model using the Heat Transfer Module. Its Heat Transfer interface handles surface-to-surface radiation boundary conditions, making it easy to verify the results. Figure 3 shows the temperature on the 3D cylinder's surface, while Figure 4 compares the temperature distributions along the axial direction for the 1D and 3D models. Clearly the results are in excellent agreement.

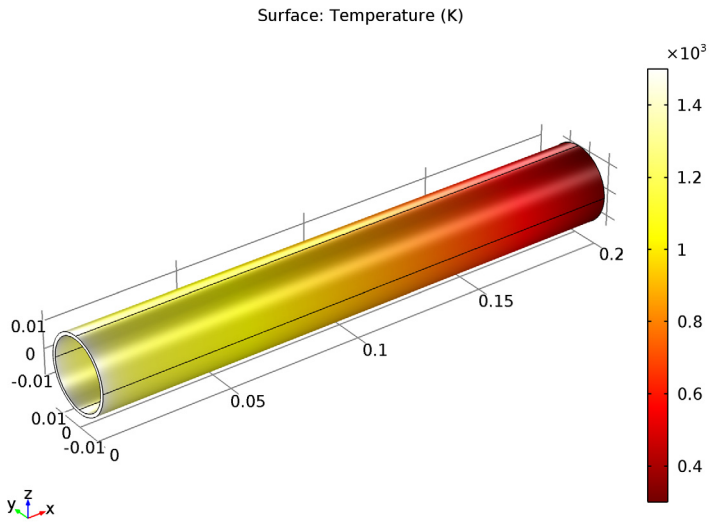

Figure 3: 3D temperature distribution in the pipe.

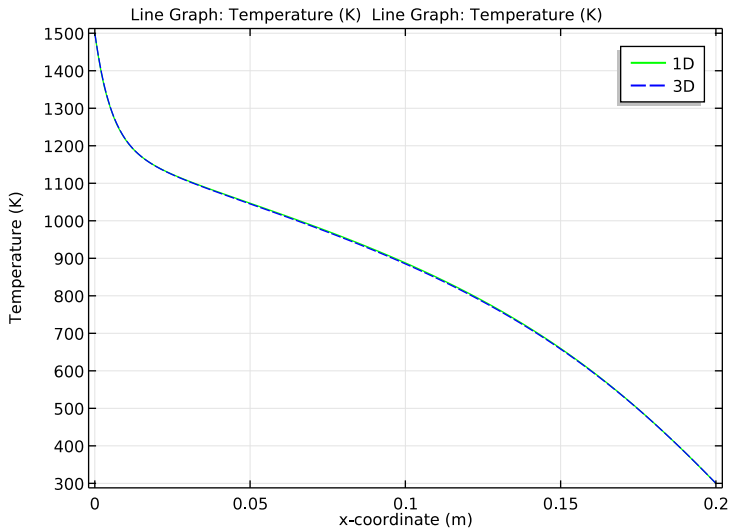

Figure 4: The temperature distributions for the 1D model and the 3D model.

## *Notes About the COMSOL Implementation*

---

To model the equation, use the Heat Transfer interface and include the radiation effects in the source term,  $Q$ , using a nonlocal integration coupling.

To enter convolution integrals of the type needed here, use the `dest` operator, which instructs COMSOL Multiphysics to evaluate the expression on which it operates on the destination points instead of the source points. In the expression  $k(x, x')$ ,  $x'$  is the variable to integrate over, whereas the model does not integrate over  $x$ . To specify that  $x$  should remain a coordinate variable that can take on values from the entire domain, write it as `dest(x)` inside the nonlocal integration coupling.

## *Reference*

---

1. R. Siegel and J. Howell, *Thermal Radiation Heat Transfer*, 4th ed., Taylor & Francis Group, New York, 2001.

---

**Application Library path:** COMSOL\_Multiphysics/Equation\_Based/integro\_partial

---

## *Modeling Instructions*



---

From the **File** menu, choose **New**.

### **NEW**

In the **New** window, click  **Model Wizard**.

### **MODEL WIZARD**

- 1 In the **Model Wizard** window, click  **ID**.
- 2 In the **Select Physics** tree, select **Heat Transfer > Heat Transfer in Solids (ht)**.
- 3 Click **Add**.
- 4 Click  **Study**.
- 5 In the **Select Study** tree, select **General Studies > Time Dependent**.
- 6 Click  **Done**.

## GLOBAL DEFINITIONS

### Parameters I

- 1 In the **Model Builder** window, under **Global Definitions** click **Parameters I**.
- 2 In the **Settings** window for **Parameters**, locate the **Parameters** section.
- 3 In the table, enter the following settings:

Name	Expression	Value	Description
epsilon	1	1	Emissivity
T_cold	300[K]	300 K	Temperature, cold end
DT_max	1200[K]	1200 K	Maximum temperature difference
T_init	T_cold	300 K	Initial temperature
D_i	1[in]	0.0254 m	Inner diameter
D_o	1.1*D_i	0.02794 m	Outer diameter
L	0.2[m]	0.2 m	Length

## GEOMETRY I

### Interval I (iI)

- 1 In the **Model Builder** window, under **Component I (comp1)** right-click **Geometry I** and choose **Interval**.
- 2 In the **Settings** window for **Interval**, locate the **Interval** section.
- 3 In the table, enter the following settings:

Coordinates (m)
0
L

- 4 Click  **Build All Objects**.

## DEFINITIONS

Define variables for the radiation terms on the left-hand side of [Equation 1](#). For this purpose, you need a nonlocal integration coupling.

### Integration I (intopI)

- 1 In the **Definitions** toolbar, click  **Nonlocal Couplings** and choose **Integration**.
- 2 In the **Settings** window for **Integration**, locate the **Source Selection** section.
- 3 From the **Selection** list, choose **All domains**.

### Variables 1

- 1 In the **Definitions** toolbar, click  **Local Variables**.
- 2 In the **Settings** window for **Variables**, locate the **Geometric Entity Selection** section.
- 3 From the **Geometric entity level** list, choose **Domain**.
- 4 From the **Selection** list, choose **All domains**.
- 5 Locate the **Variables** section. In the table, enter the following settings:

Name	Expression	Unit	Description
$x_i$	$\text{abs}(\text{dest}(x) - x) / D_i$		
$k$	$1 - (2 \cdot x_i^3 + 3 \cdot x_i) / (2 \cdot (x_i^2 + 1)^{1.5})$		Integral kernel
$Q_{\text{source}}$	$4 / (D_o^2 - D_i^2) \cdot \epsilon \cdot \sigma_{\text{const}} \cdot \text{intop1}(k \cdot T^4)$	W/m <sup>3</sup>	Heat source
$Q_{\text{loss}}$	$-4 \cdot D_i / (D_o^2 - D_i^2) \cdot \epsilon \cdot \sigma_{\text{const}} \cdot T^4$	W/m <sup>3</sup>	Heat loss

## MATERIALS

### Material 1 (mat1)

- 1 In the **Model Builder** window, under **Component 1 (comp1)** right-click **Materials** and choose **Blank Material**.

By default, the first material applies for all domains. COMSOL Multiphysics indicates any undefined material parameters required by the physics interfaces defined on those domains.

- 2 In the **Settings** window for **Material**, locate the **Material Contents** section.
- 3 In the table, enter the following settings:

Property	Variable	Value	Unit	Property group
Thermal conductivity	$k_{\text{iso}} ; k_{ij} = k_{\text{iso}}, k_{ij} = 0$	13	W/(m·K)	Basic
Density	$\rho$	8700	kg/m <sup>3</sup>	Basic
Heat capacity at constant pressure	$C_p$	300	J/(kg·K)	Basic

## HEAT TRANSFER IN SOLIDS (HT)

### *Solid 1*

The material parameters you just defined suffice to fully determine the **Solid** node. Add a separate **Heat Source** node for the radiation terms in [Equation 1](#).

### *Heat Source 1*

- 1 In the **Physics** toolbar, click  **Domains** and choose **Heat Source**.
- 2 In the **Settings** window for **Heat Source**, locate the **Domain Selection** section.
- 3 From the **Selection** list, choose **All domains**.
- 4 Locate the **Heat Source** section. In the  $Q_0$  text field, type  $Q_{\text{source}}+Q_{\text{loss}}$ .

### *Initial Values 1*

- 1 In the **Model Builder** window, click **Initial Values 1**.
- 2 In the **Settings** window for **Initial Values**, locate the **Initial Values** section.
- 3 In the  $T$  text field, type  $T_{\text{init}}$ .

### *Temperature 1*

- 1 In the **Physics** toolbar, click  **Boundaries** and choose **Temperature**.
- 2 Select Boundary 1 only.
- 3 In the **Settings** window for **Temperature**, locate the **Temperature** section.
- 4 In the  $T_0$  text field, type  $T_{\text{cold}}+DT_{\text{max}}*\tanh(t/1[\text{min}])$ .

### *Temperature 2*

- 1 In the **Physics** toolbar, click  **Boundaries** and choose **Temperature**.
- 2 Select Boundary 2 only.
- 3 In the **Settings** window for **Temperature**, locate the **Temperature** section.
- 4 In the  $T_0$  text field, type  $T_{\text{cold}}$ .

## MESH 1

- 1 In the **Model Builder** window, under **Component 1 (comp1)** click **Mesh 1**.
- 2 In the **Settings** window for **Mesh**, locate the **Physics-Controlled Mesh** section.
- 3 From the **Element size** list, choose **Extra fine**.
- 4 Click  **Build All**.

## STUDY 1

### Step 1: Time Dependent

- 1 In the **Model Builder** window, under **Study 1** click **Step 1: Time Dependent**.
- 2 In the **Settings** window for **Time Dependent**, locate the **Study Settings** section.
- 3 In the **Output times** text field, type range (0, 1 [min], 1 [h]).

To compare the temperature distribution in the radiation model with that of a model without radiation, add a parametric sweep with the emissivity as the parameter taking the values 0 and 1.

### Parametric Sweep

- 1 In the **Study** toolbar, click  **Parametric Sweep**.
- 2 In the **Settings** window for **Parametric Sweep**, locate the **Study Settings** section.
- 3 Click **+ Add**.
- 4 In the table, enter the following settings:

Parameter name	Parameter value list
epsilon (Emissivity)	0 1

- 5 In the **Study** toolbar, click  **Compute**.

## RESULTS

The default plot shows the solution for all time steps. Reproduce the plot in [Figure 2](#) comparing the solutions at the last time step as follows.

### Temperature (ht)

- 1 In the **Model Builder** window, under **Results** click **Temperature (ht)**.
- 2 In the **Settings** window for **ID Plot Group**, locate the **Data** section.
- 3 From the **Time selection** list, choose **Last**.

### Line Graph 1

- 1 In the **Model Builder** window, expand the **Temperature (ht)** node, then click **Line Graph 1**.
- 2 In the **Settings** window for **Line Graph**, click to expand the **Legends** section.
- 3 Select the **Show legends** checkbox.
- 4 In the **Temperature (ht)** toolbar, click  **Plot**.