



Model created in COMSOL Multiphysics 6.4

# Ultrahigh Vacuum, Chemical Vapor Deposition

## *Introduction*

---

Chemical vapor deposition (CVD) is a process often used in the semiconductor industry for epitaxial layer growth of high-purity silicon on top of a wafer substrate.

CVD is achieved using many different techniques and across a range of pressures; however, of particular commercial interest is the multilayer ultrahigh vacuum (UHV)/CVD technique.

UHV/CVD is performed at pressures below  $10^{-6}$  Pa ( $10^{-8}$  Torr), so gas transport is achieved by molecular flow and lacks any hydrodynamic effects such as boundary layers. In addition, there is also no gas-phase chemistry involved due to the low frequency of molecular collisions, so growth rate will be determined by the number density of species and surface molecular decomposition processes.

## *Model Definition*

---

Typically wafers are arranged close together (relative to their diameters) on a movable wafer boat within a quartz tube, surrounded by a furnace. Reactant gases are introduced at one end via a load lock together with a dilution gas such as hydrogen. A turbopump is present at the other end of the quartz tube.

The model geometry is shown in [Figure 1](#). The wafer cassette is positioned within the quartz chamber by means of a delivery rail.

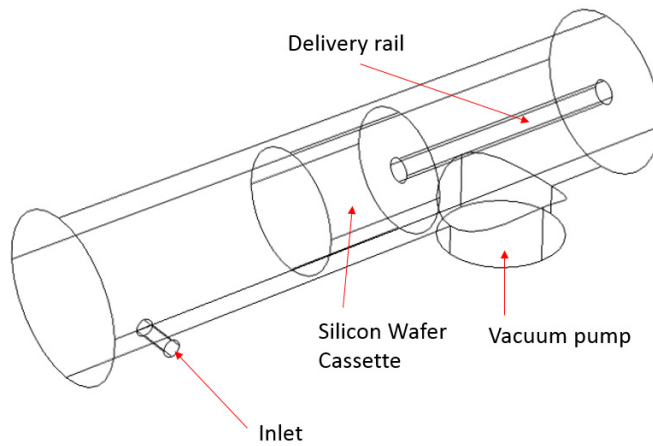

*Figure 1: Model geometry. Key components of the system are labeled.*

The reactant gas, silane ( $\text{SiH}_4$ ) along with a dilution gas, hydrogen ( $\text{H}_2$ ) enters through the inlet. The total gas mass flow rate is 1 SCCM (0.2 SCCM  $\text{SiH}_4$ , 0.8 SCCM  $\text{H}_2$ ). The outgassing wall boundary condition is used for this inlet.

A vacuum pump is positioned at the other end of the chamber at the cylindrical port. Three different pumping curves are investigated for both the hydrogen and the silane. These pumping curves are loaded into COMSOL Multiphysics as interpolations functions and are switched between using a sweep parameter that will allow us to run the model for each curve.

All other surfaces in the model are walls.

## *Results and Discussion*

---

The molecular flux fraction of  $\text{SiH}_4$  at the wafer cassette, using pumping curves 2, is shown in [Figure 2](#). The interesting result is that the molecular flux fraction of silane at the wafer cassette is significantly different from what is introduced at the inlet. As this directly controls the growth on the wafers, the choice of pump seems to be important. In addition, this molecular flux fraction cannot easily be measured at the wafer so its important to use models like this to investigate the process fully.

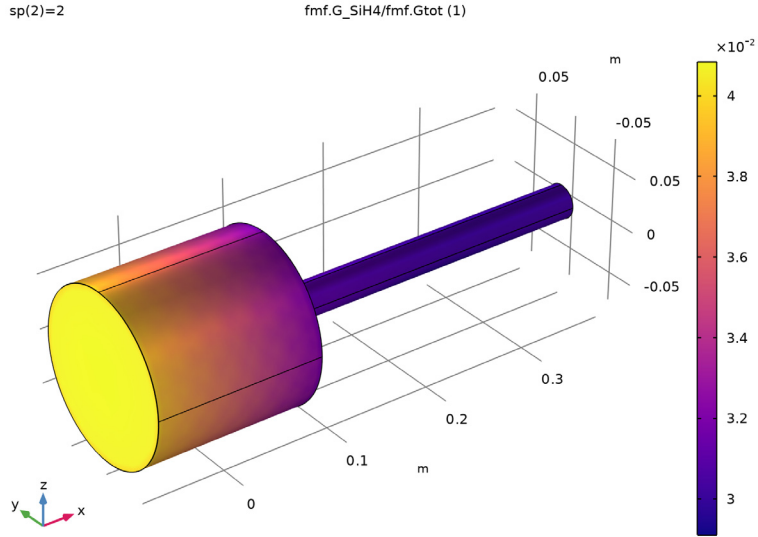

Figure 2: Molecular flux fraction of SiH<sub>4</sub> at the water cassette.

### Reference

1. B. S. Meyerson, *Appl. Phys. Lett.* 48, pp. 797–799, 1986.

---

**Application Library path:** Molecular\_Flow\_Module/Industrial\_Applications/  
uhv\_cvd

---

### Modeling Instructions



From the **File** menu, choose **New**.

#### NEW

In the **New** window, click  **Model Wizard**.

#### MODEL WIZARD

1 In the **Model Wizard** window, click  **3D**.

- 2 In the **Select Physics** tree, select **Fluid Flow > Rarefied Flow > Free Molecular Flow (fmf)**.
- 3 Click **Add**.
- 4 Click  **Study**.
- 5 In the **Select Study** tree, select **General Studies > Stationary**.
- 6 Click  **Done**.

## GLOBAL DEFINITIONS

### *Parameters 1*

- 1 In the **Model Builder** window, under **Global Definitions** click **Parameters 1**.
- 2 In the **Settings** window for **Parameters**, locate the **Parameters** section.
- 3 Click  **Load from File**.
- 4 Browse to the model's Application Libraries folder and double-click the file `uhv_cvd_parameters.txt`.

## GEOMETRY 1

The geometry consists of a cylindrical chamber with an inlet and vacuum pump at either end. A cassette of silicon wafers is approximated by a cylinder of narrower diameter on the end of a delivery rail.

### *Cylinder 1 (cyl1)*

- 1 In the **Geometry** toolbar, click  **Cylinder**.
- 2 In the **Settings** window for **Cylinder**, locate the **Size and Shape** section.
- 3 In the **Radius** text field, type  $R0$ .
- 4 In the **Height** text field, type  $L0$ .
- 5 Locate the **Position** section. In the **x** text field, type  $-L0/2$ .
- 6 Locate the **Axis** section. From the **Axis type** list, choose **x-axis**.
- 7 Locate the **Position** section. In the **x** text field, type  $-L0/2$ .

### *Cylinder 2 (cyl2)*

- 1 In the **Geometry** toolbar, click  **Cylinder**.
- 2 In the **Settings** window for **Cylinder**, locate the **Size and Shape** section.
- 3 In the **Radius** text field, type  $Dp/2$ .
- 4 In the **Height** text field, type  $Dp/4+R0$ .
- 5 Locate the **Position** section. In the **x** text field, type  $0.3*L0$ .
- 6 In the **z** text field, type  $-(R0+Dp/4)$ .

#### *Union 1 (uni1)*

- 1 In the **Geometry** toolbar, click  **Booleans and Partitions** and choose **Union**.
- 2 Click in the **Graphics** window and then press Ctrl+A to select both objects.
- 3 In the **Settings** window for **Union**, locate the **Union** section.
- 4 Clear the **Keep interior boundaries** checkbox.



#### *Cylinder 3 (cyl3)*

- 1 In the **Geometry** toolbar, click  **Cylinder**.
- 2 In the **Settings** window for **Cylinder**, locate the **Size and Shape** section.
- 3 In the **Radius** text field, type  $DW/2$ .
- 4 In the **Height** text field, type  $LW$ .
- 5 Locate the **Position** section. In the **x** text field, type  $-LW/2$ .
- 6 Locate the **Axis** section. From the **Axis type** list, choose **x-axis**.



#### *Cylinder 4 (cyl4)*

- 1 In the **Geometry** toolbar, click  **Cylinder**.
- 2 In the **Settings** window for **Cylinder**, locate the **Size and Shape** section.
- 3 In the **Radius** text field, type  $DW/10$ .
- 4 In the **Height** text field, type  $L0/2$ .
- 5 Locate the **Axis** section. From the **Axis type** list, choose **x-axis**.

#### *Union 2 (uni2)*

- 1 In the **Geometry** toolbar, click  **Booleans and Partitions** and choose **Union**.
- 2 Click the  **Wireframe Rendering** button in the **Graphics** toolbar.
- 3 Select the objects **cyl3** and **cyl4** only.
- 4 In the **Settings** window for **Union**, locate the **Union** section.
- 5 Clear the **Keep interior boundaries** checkbox.



#### *Difference 1 (dif1)*

- 1 In the **Geometry** toolbar, click  **Booleans and Partitions** and choose **Difference**.
- 2 Select the object **uni1** only.
- 3 In the **Settings** window for **Difference**, locate the **Difference** section.
- 4 Click to select the  **Activate Selection** toggle button for **Objects to subtract**.
- 5 Select the object **uni2** only.

### *Cylinder 5 (cyl5)*

- 1 In the **Geometry** toolbar, click  **Cylinder**.
- 2 In the **Settings** window for **Cylinder**, locate the **Size and Shape** section.
- 3 In the **Radius** text field, type  $R_{in}$ .
- 4 In the **Height** text field, type  $1.5 * (R_0)$ .
- 5 Locate the **Position** section. In the **x** text field, type  $-0.9 * L_0 / 2$ .
- 6 In the **y** text field, type  $-1.5 * R_0$ .
- 7 Locate the **Axis** section. From the **Axis type** list, choose **y-axis**.

### *Difference 2 (dif2)*

- 1 In the **Geometry** toolbar, click  **Booleans and Partitions** and choose **Difference**.
- 2 Select the object **cyl5** only.
- 3 In the **Settings** window for **Difference**, locate the **Difference** section.
- 4 Click to select the  **Activate Selection** toggle button for **Objects to subtract**.
- 5 Select the object **dif1** only.
- 6 Select the **Keep objects to subtract** checkbox.
- 7 Click  **Build All Objects**.

## **DEFINITIONS**

Set up some selections to assist during postprocessing.



### *Cassette*

- 1 In the **Definitions** toolbar, click  **Explicit**.
- 2 In the **Settings** window for **Explicit**, locate the **Input Entities** section.
- 3 From the **Geometric entity level** list, choose **Boundary**.
- 4 Select Boundaries 13–18 only.
- 5 In the **Label** text field, type *Cassette*.

### *Cassette and rail*

- 1 In the **Definitions** toolbar, click  **Explicit**.
- 2 In the **Settings** window for **Explicit**, locate the **Input Entities** section.
- 3 From the **Geometric entity level** list, choose **Boundary**.
- 4 Select Boundaries 13–22 only.
- 5 In the **Label** text field, type *Cassette and rail*.

### Interpolation 1 (int1)



- 1 In the **Definitions** toolbar, click  **Interpolation**.
- 2 In the **Settings** window for **Interpolation**, locate the **Definition** section.
- 3 Click  **Load from File**.
- 4 Browse to the model's Application Libraries folder and double-click the file `uhv_cvd_turbopump01_H2.txt`.
- 5 In the **Function name** text field, type `pump1_H2`.
- 6 Locate the **Units** section. In the **Argument** table, enter the following settings:

Argument	Unit
t	hPa

- 7 In the **Function** table, enter the following settings:

Function	Unit
pump1_H2	1/s

### Interpolation 2 (int2)

- 1 In the **Definitions** toolbar, click  **Interpolation**.
- 2 In the **Settings** window for **Interpolation**, locate the **Definition** section.
- 3 Click  **Load from File**.
- 4 Browse to the model's Application Libraries folder and double-click the file `uhv_cvd_turbopump02_H2.txt`.
- 5 In the **Function name** text field, type `pump2_H2`.
- 6 Locate the **Units** section. In the **Argument** table, enter the following settings:

Argument	Unit
t	hPa

- 7 In the **Function** table, enter the following settings:

Function	Unit
pump2_H2	1/s

### Interpolation 3 (int3)

- 1 In the **Definitions** toolbar, click  **Interpolation**.
- 2 In the **Settings** window for **Interpolation**, locate the **Definition** section.
- 3 Click  **Load from File**.



- 4 Browse to the model's Application Libraries folder and double-click the file uhv\_cvd\_turbopump03\_H2.txt.
- 5 In the **Function name** text field, type pump3\_H2.
- 6 Locate the **Units** section. In the **Argument** table, enter the following settings:

Argument	Unit
t	hPa

- 7 In the **Function** table, enter the following settings:

Function	Unit
pump3_H2	l/s

#### *Interpolation 4 (int4)*



- 1 In the **Definitions** toolbar, click  **Interpolation**.
- 2 In the **Settings** window for **Interpolation**, locate the **Definition** section.
- 3 Click  **Load from File**.
- 4 Browse to the model's Application Libraries folder and double-click the file uhv\_cvd\_turbopump01\_SiH4.txt.
- 5 In the **Function name** text field, type pump1\_SiH4.
- 6 Locate the **Units** section. In the **Argument** table, enter the following settings:

Argument	Unit
t	hPa

- 7 In the **Function** table, enter the following settings:

Function	Unit
pump1_SiH4	l/s

#### *Interpolation 5 (int5)*

- 1 In the **Definitions** toolbar, click  **Interpolation**.
- 2 In the **Settings** window for **Interpolation**, locate the **Definition** section.
- 3 Click  **Load from File**.
- 4 Browse to the model's Application Libraries folder and double-click the file uhv\_cvd\_turbopump02\_SiH4.txt.
- 5 In the **Function name** text field, type pump2\_SiH4.

6 Locate the **Units** section. In the **Argument** table, enter the following settings:

Argument	Unit
t	hPa

7 In the **Function** table, enter the following settings:

Function	Unit
pump2_SiH4	1/s

*Interpolation 6 (int6)*

1 In the **Definitions** toolbar, click  **Interpolation**.

2 In the **Settings** window for **Interpolation**, locate the **Definition** section.

3 Click  **Load from File**.

4 Browse to the model's Application Libraries folder and double-click the file uhv\_cvd\_turbopump03\_SiH4.txt.

5 In the **Function name** text field, type pump3\_SiH4.

6 Locate the **Units** section. In the **Argument** table, enter the following settings:

Argument	Unit
t	hPa

7 In the **Function** table, enter the following settings:

Function	Unit
pump3_SiH4	1/s

Set up two species, silane (SiH4) and hydrogen (H2) as a dilution gas.

### FREE MOLECULAR FLOW (FMF)

1 In the **Model Builder** window, under **Component 1 (comp1)** click **Free Molecular Flow (fmf)**.

2 In the **Settings** window for **Free Molecular Flow**, click to expand the **Dependent Variables** section.

3 In the **Number of species** text field, type 2.

4 In the **Incident molecular fluxes (1/(m<sup>2</sup>·s))** table, enter the following settings:

H2
SiH4

5 Locate the **Compute** section. Clear the **Number density** checkbox.

Specify the molecular weights for both species.

#### *Molecular Flow 1*

1 In the **Model Builder** window, under **Component 1 (comp1) > Free Molecular Flow (fmf)** click **Molecular Flow 1**.

2 In the **Settings** window for **Molecular Flow**, locate the **Molecular Weight of Species** section.

3 In the  $M_{n,H2}$  text field, type 2[g/mol].

4 In the  $M_{n,SiH4}$  text field, type 32.12[g/mol].

Set the temperature of the surrounding furnace.

#### *Surface Temperature 1*

1 In the **Model Builder** window, click **Surface Temperature 1**.

2 In the **Settings** window for **Surface Temperature**, locate the **Surface Temperature** section.

3 In the  $T$  text field, type  $T_f$ .

Add an outgassing wall to the inlet with the mass flows of each species.

#### *Wall 2*

1 In the **Physics** toolbar, click  **Boundaries** and choose **Wall**.

2 Select Boundary 8 only.

3 In the **Settings** window for **Wall**, locate the **Wall Type** section.

4 From the **Wall type** list, choose **Outgassing wall**.

5 Locate the **Flux** section. From the **Outgoing flux** list, choose **Number of SCCM units**.

6 In the  $Q_{sccm,H2}$  text field, type sccmH2.

7 In the  $Q_{sccm,SiH4}$  text field, type sccmSiH4.

Add a vacuum pump and specify the pump speed for each species.

#### *Vacuum Pump 1*

1 In the **Physics** toolbar, click  **Boundaries** and choose **Vacuum Pump**.

2 Select Boundary 25 only.

3 In the **Settings** window for **Vacuum Pump**, locate the **Vacuum Pump** section.

4 From the **Specify pump flux** list, choose **Pump speed**.

5 In the  $S_{H2}$  text field, type  $\text{pump1\_H2}(\text{fmf}.\text{ptot}) * (\text{sp}==1) + \text{pump2\_H2}(\text{fmf}.\text{ptot}) * (\text{sp}==2) + \text{pump3\_H2}(\text{fmf}.\text{ptot}) * (\text{sp}==3)$ .

- 6 In the  $S_{\text{SiH}_4}$  text field, type  $\text{pump1\_SiH}_4(\text{fmf.ptot}) * (\text{sp}==1) + \text{pump2\_SiH}_4(\text{fmf.ptot}) * (\text{sp}==2) + \text{pump3\_SiH}_4(\text{fmf.ptot}) * (\text{sp}==3)$ .

Add a surface mesh.

## MESH 1

### Free Triangular 1

- 1 In the **Mesh** toolbar, click  **More Generators** and choose **Free Triangular**.
- 2 In the **Settings** window for **Free Triangular**, locate the **Boundary Selection** section.
- 3 From the **Selection** list, choose **Cassette and rail**.

### Size 1

- 1 Right-click **Free Triangular 1** and choose **Size**.
- 2 In the **Settings** window for **Size**, locate the **Element Size** section.
- 3 From the **Predefined** list, choose **Extra fine**.

### Free Triangular 2

- 1 In the **Mesh** toolbar, click  **More Generators** and choose **Free Triangular**.
- 2 In the **Settings** window for **Free Triangular**, locate the **Boundary Selection** section.
- 3 From the **Geometric entity level** list, choose **Remaining**.

### Size

- 1 In the **Model Builder** window, click **Size**.
- 2 In the **Settings** window for **Size**, locate the **Element Size** section.
- 3 From the **Predefined** list, choose **Finer**.

Add two average nonlocal couplings to allow the evaluation of properties on and around the wafer cassette and vacuum pump.

## DEFINITIONS

### Average 1 (aveop1)

- 1 In the **Definitions** toolbar, click  **Nonlocal Couplings** and choose **Average**.
- 2 In the **Settings** window for **Average**, locate the **Source Selection** section.
- 3 From the **Geometric entity level** list, choose **Boundary**.
- 4 From the **Selection** list, choose **Cassette**.

### Average 2 (aveop2)

- 1 In the **Definitions** toolbar, click  **Nonlocal Couplings** and choose **Average**.

- 2 In the **Settings** window for **Average**, locate the **Source Selection** section.
- 3 From the **Geometric entity level** list, choose **Boundary**.
- 4 Select Boundary 25 only.

Set the study up to cover a range of inlet mass flows for pump 1, 2, and 3.

## STUDY I

### Step 1: Stationary

- 1 In the **Model Builder** window, under **Study I** click **Step 1: Stationary**.
- 2 In the **Settings** window for **Stationary**, click to expand the **Study Extensions** section.
- 3 Select the **Auxiliary sweep** checkbox.
- 4 Click  **Add**.
- 5 In the table, enter the following settings:

Parameter name	Parameter value list	Parameter unit
sp (Sweep parameter)	1 2 3	

- 6 In the **Study** toolbar, click  **Compute**.

## RESULTS

### Study 1/Solution 1 (2) (sol1)

- 1 In the **Model Builder** window, expand the **Results > Datasets** node.
- 2 Right-click **Results > Datasets > Study 1/Solution 1 (sol1)** and choose **Duplicate**.

### Selection

- 1 In the **Results** toolbar, click  **Attributes** and choose **Selection**.
- 2 In the **Settings** window for **Selection**, locate the **Geometric Entity Selection** section.
- 3 From the **Geometric entity level** list, choose **Boundary**.
- 4 From the **Selection** list, choose **Cassette and rail**.

Add a **Global Evaluation** node to evaluate the molecular flux of SiH<sub>4</sub> and molecular flux fraction of SiH<sub>4</sub> at the position of the cassette, as well as the average pressure at the vacuum pump.

### Global Evaluation 1

- 1 In the **Results** toolbar, click  **Global Evaluation**.
- 2 In the **Settings** window for **Global Evaluation**, locate the **Expressions** section.

3 In the table, enter the following settings:

Expression	Unit	Description
aveop1(fmf.G_SiH4)	1/(m <sup>2</sup> *s)	SiH4 flux
aveop1(fmf.G_SiH4/fmf.Gtot)	1	Flux fraction
aveop2(fmf.ptot)	Pa	Pump pressure

4 Click  **Evaluate**.

#### *Molecular Flux Fraction SiH4*

- 1 In the **Results** toolbar, click  **3D Plot Group**.
- 2 In the **Settings** window for **3D Plot Group**, type Molecular Flux Fraction SiH4 in the **Label** text field.
- 3 Locate the **Data** section. From the **Dataset** list, choose **Study 1/Solution 1 (2) (sol1)**.
- 4 From the **Parameter value (sp)** list, choose **2**.

#### *Surface 1*

- 1 Right-click **Molecular Flux Fraction SiH4** and choose **Surface**.
- 2 In the **Settings** window for **Surface**, locate the **Expression** section.
- 3 In the **Expression** text field, type `fmf.G_SiH4/fmf.Gtot`.
- 4 Locate the **Coloring and Style** section. From the **Color table** list, choose **Plasma**.
- 5 In the **Molecular Flux Fraction SiH4** toolbar, click  **Plot**.