



Model created in COMSOL Multiphysics 6.4

Molecular Flow Through an RF Coupler

Introduction

Computing molecular flows in arbitrary geometries produces complex integral equations that are very difficult to compute analytically. There are two widely accepted methods for modeling molecular flows, the Monte Carlo method (which computes the trajectories of large numbers of randomized particles through the system) and the angular coefficient method. The Free Molecular Flow interfaces uses the angular coefficient method, which computes the molecular flow by summing the flux arriving at a surface from all other surfaces in its line of sight. The macroscopic variables in the vicinity of the surface can be derived from kinetic theory. The Mathematical Particle Tracing interface, available in the Particle Tracing Module can be used to implement the Monte Carlo method for molecular flows. The transmission probability can be computed and compared to the angular coefficient method.

Note: This model requires the Particle Tracing Module.

Model Definition

Particle trajectories are computed using Newton's law of motion:

$$\frac{d}{dt}\left(m\frac{d\mathbf{q}}{dt}\right) = 0$$

The particle velocity is given by

$$\mathbf{v} = \frac{d\mathbf{q}}{dt}$$

When the particles encounter a boundary, they scatter according to Knudsen's law:

$$v_{t1} = c \cos\phi \sin\theta$$

$$v_{t2} = c \sin\phi \sin\theta$$

$$v_n = c \cos\theta$$

Here, the subscript t denotes the tangential component of the velocity and n the normal. In addition, c is the particle speed which is sampled from the following probability density function:

$$\rho(c) = \frac{1}{2} \left(\frac{m}{k_B T} \right)^2 c^3 \exp\left(-\frac{mc^2}{2k_B T} \right)$$

This is accomplished using the normally distributed random function, which is used to assign a new normally distributed random speed to each particle at each time step. The angle ϕ is a uniformly distributed random number between 0 and π . The angle, θ is a random angle, which is defined by the piecewise function:

$$\begin{aligned} \theta &= -\text{asin}(\sqrt{1-2g}) & \text{for } 0 < g < 0.5 \\ \theta &= \text{asin}(\sqrt{2g-1}) & \text{for } 0.5 < g < 1 \end{aligned}$$

where g is a random number between 0 and 1. In all 10,000 particles are released into the modeling domain. The number of particles that reaches the outlet boundary determines the transmission probability.

The transmission probability for the molecular flow interface is given by the following ratio:

$$\chi = \frac{\int_{\text{outlet}} (J - G) dl}{\int_{\text{inlet}} (J - G) dl}$$

Results and Discussion

The molecular flux computed by the angular coefficient method is shown in [Figure 1](#). The transmission probability based on this is computed to be 0.21749. Using the particle based approach the transmission probability comes out to be 0.2136. Of course, using stricter tolerances and including more particles in the simulation provides better agreement with the angular coefficient method, at the expense of additional CPU time.

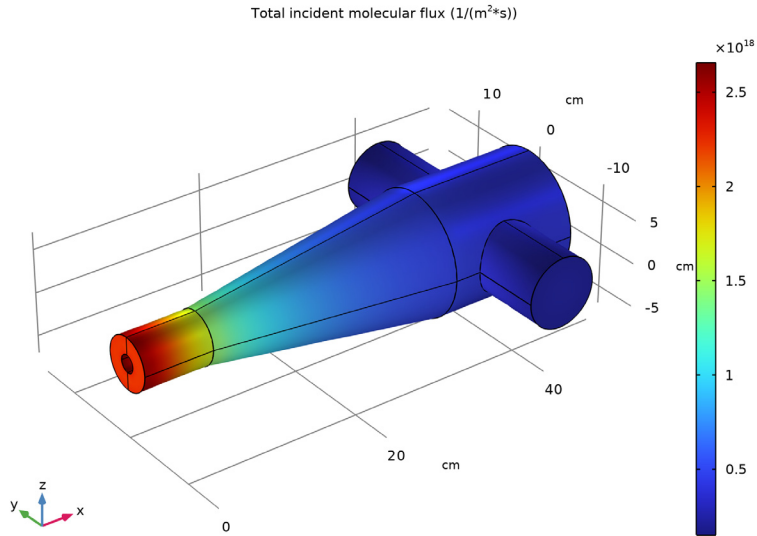

Figure 1: Plot of the incident molecular flux.

Notes About the COMSOL Implementation

The model is solved in two stages. First the Free Molecular Flow interface is used to compute the transmission probability using a Stationary study. Subsequently, the Mathematical Particle Tracing interface is used to compute the transmission probability with a Time Dependent study using a Monte Carlo approach.

Application Library path: Molecular_Flow_Module/Benchmarks/rf_coupler



Modeling Instructions

From the **File** menu, choose **New**.

NEW

In the **New** window, click  **Model Wizard**.

MODEL WIZARD

- 1 In the **Model Wizard** window, click  **3D**.
- 2 In the **Select Physics** tree, select **Fluid Flow > Rarefied Flow > Free Molecular Flow (fmf)**.
- 3 Click **Add**.
- 4 Click  **Study**.
- 5 In the **Select Study** tree, select **General Studies > Stationary**.
- 6 Click  **Done**.

GLOBAL DEFINITIONS

Parameters 1

- 1 In the **Model Builder** window, under **Global Definitions** click **Parameters 1**.
- 2 In the **Settings** window for **Parameters**, locate the **Parameters** section.
- 3 In the table, enter the following settings:



Name	Expression	Value	Description
T0	293.15 [K]	293.15 K	Temperature
Mw	0.028 [kg/mol]	0.028 kg/mol	Molecular weight
p0	1E-4 [Pa]	1E-4 Pa	Inlet pressure
frac	0.7	0.7	Fraction of molecules pumped

GEOMETRY 1

- 1 In the **Model Builder** window, under **Component 1 (comp1)** click **Geometry 1**.
- 2 In the **Settings** window for **Geometry**, locate the **Units** section.
- 3 From the **Length unit** list, choose **cm**.

The geometry is built by first revolving a cross section defined in a work plane.

Work Plane 1 (wp1)



- 1 In the **Geometry** toolbar, click  **Work Plane**.
- 2 In the **Settings** window for **Work Plane**, locate the **Plane Definition** section.
- 3 From the **Plane** list, choose **yx-plane**.
- 4 Click  **Go to Plane Geometry**.

Work Plane 1 (wp1) > Rectangle 1 (r1)

- 1 In the **Work Plane** toolbar, click  **Rectangle**.

- 2 In the **Settings** window for **Rectangle**, locate the **Size and Shape** section.
- 3 In the **Width** text field, type 2.
- 4 In the **Height** text field, type 8.
- 5 Locate the **Position** section. In the **xw** text field, type 1.
- 6 In the **Work Plane** toolbar, click  **Build All**.



Work Plane 1 (wp1) > Polygon 1 (pol1)

- 1 In the **Work Plane** toolbar, click  **Polygon**.
- 2 In the **Settings** window for **Polygon**, locate the **Coordinates** section.
- 3 From the **Data source** list, choose **Vectors**.
- 4 In the **xw** text field, type 1 3 3 7 7 3 3 1.
- 5 In the **yw** text field, type 8 35 35 35 35 8 8 8.
- 6 In the **Work Plane** toolbar, click  **Build All**.
- 7 Click the  **Zoom Extents** button in the **Graphics** toolbar.

Work Plane 1 (wp1) > Rectangle 2 (r2)



- 1 In the **Work Plane** toolbar, click  **Rectangle**.
- 2 In the **Settings** window for **Rectangle**, locate the **Size and Shape** section.
- 3 In the **Width** text field, type 4.
- 4 In the **Height** text field, type 15.
- 5 Locate the **Position** section. In the **xw** text field, type 3.
- 6 In the **yw** text field, type 35.

Work Plane 1 (wp1) > Union 1 (uni1)



- 1 In the **Work Plane** toolbar, click  **Booleans and Partitions** and choose **Union**.
- 2 Click in the **Graphics** window and then press Ctrl+A to select all objects.
- 3 In the **Settings** window for **Union**, locate the **Union** section.
- 4 Clear the **Keep interior boundaries** checkbox.
- 5 In the **Work Plane** toolbar, click  **Build All**.
- 6 Click the  **Zoom Extents** button in the **Graphics** toolbar.

Revolve 1 (rev1)



- 1 In the **Model Builder** window, right-click **Geometry 1** and choose **Revolve**.
- 2 In the **Settings** window for **Revolve**, locate the **Revolution Angles** section.
- 3 Click the **Angles** button.

- 4 In the **Start angle** text field, type -90.
- 5 In the **End angle** text field, type 90.
- 6 Click  **Build All Objects**.
- 7 Click the  **Go to Default View** button in the **Graphics** toolbar.

Cylinder 1 (cyl1)

- 1 In the **Geometry** toolbar, click  **Cylinder**.
- 2 In the **Settings** window for **Cylinder**, locate the **Size and Shape** section.
- 3 In the **Radius** text field, type 4.
- 4 In the **Height** text field, type 10.
- 5 Locate the **Position** section. In the **x** text field, type 42.
- 6 In the **y** text field, type 5.
- 7 Locate the **Axis** section. From the **Axis type** list, choose **y-axis**.
- 8 Click  **Build All Objects**.

Union 1 (un1)

- 1 In the **Geometry** toolbar, click  **Booleans and Partitions** and choose **Union**.
- 2 Click in the **Graphics** window and then press Ctrl+A to select both objects.
- 3 In the **Settings** window for **Union**, locate the **Union** section.
- 4 Clear the **Keep interior boundaries** checkbox.
- 5 Click  **Build All Objects**.

Ignore Edges 1 (ige1)

- 1 In the **Geometry** toolbar, click  **Virtual Operations** and choose **Ignore Edges**.

2 On the object **fin**, select Edge 11 only.

It might be easier to select the correct edge by using the **Selection List** window. To open this window, in the **Home** toolbar click **Windows** and choose **Selection List**. (If you are running the cross-platform desktop, you find **Windows** in the main menu.)

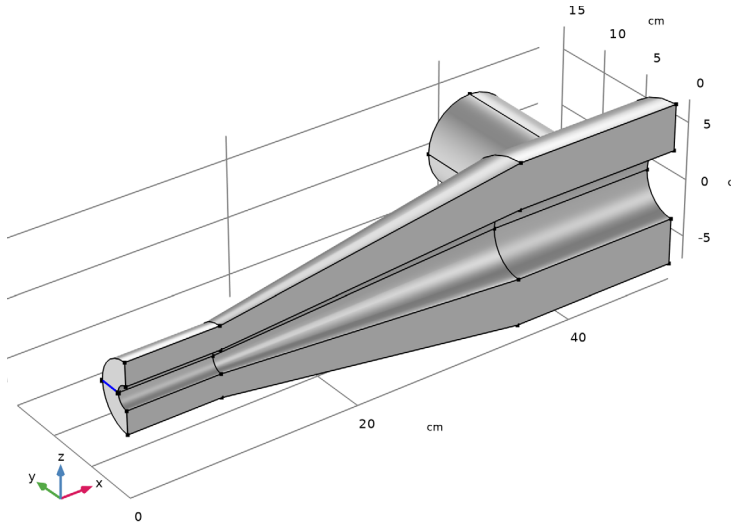

FREE MOLECULAR FLOW (FMF)

Molecular Flow 1

- 1 In the **Model Builder** window, under **Component 1 (comp1) > Free Molecular Flow (fmf)** click **Molecular Flow 1**.
- 2 In the **Settings** window for **Molecular Flow**, locate the **Molecular Weight of Species** section.
- 3 In the $M_{n,G}$ text field, type Mw.

Surface Temperature 1



- 1 In the **Model Builder** window, click **Surface Temperature 1**.
- 2 In the **Settings** window for **Surface Temperature**, locate the **Surface Temperature** section.
- 3 In the T text field, type T0.

Reservoir 1

- 1 In the **Physics** toolbar, click  **Boundaries** and choose **Reservoir**.
- 2 Select Boundary 1 only.
- 3 In the **Settings** window for **Reservoir**, locate the **Reservoir** section.

4 In the $p_{0,G}$ text field, type p0.

Vacuum Pump 1

- 1 In the **Physics** toolbar, click  **Boundaries** and choose **Vacuum Pump**.
- 2 Click the  **Wireframe Rendering** button in the **Graphics** toolbar.
- 3 Select Boundary 18 only.
- 4 In the **Settings** window for **Vacuum Pump**, locate the **Vacuum Pump** section.
- 5 In the f_G text field, type frac.

FREE MOLECULAR FLOW (FMF)

Symmetry 1

- 1 In the **Model Builder** window, expand the **Component 1 (comp1) > Definitions** node.
- 2 Right-click **Component 1 (comp1) > Free Molecular Flow (fmf)** and choose **Global > Symmetry**.
- 3 Select Boundaries 2 and 5 only.

DEFINITIONS

Define a nonlocal integration coupling on the inlet and outlet to help compute the transmission probability.

Integration 1 (intop1)

- 1 In the **Definitions** toolbar, click  **Nonlocal Couplings** and choose **Integration**.
- 2 In the **Settings** window for **Integration**, locate the **Source Selection** section.
- 3 From the **Geometric entity level** list, choose **Boundary**.
- 4 Select Boundary 1 only.

Integration 2 (intop2)

- 1 In the **Definitions** toolbar, click  **Nonlocal Couplings** and choose **Integration**.
- 2 In the **Settings** window for **Integration**, locate the **Source Selection** section.
- 3 From the **Geometric entity level** list, choose **Boundary**.
- 4 Select Boundary 18 only.

Molecular Flow Variables

- 1 In the **Definitions** toolbar, click  **Local Variables**.
- 2 In the **Settings** window for **Variables**, type Molecular Flow Variables in the **Label** text field.

3 Locate the **Variables** section. In the table, enter the following settings:

Name	Expression	Unit	Description
Jin	intop1(fmf.J_G)	l/s	Influx
Jout	intop2(G-fmf.J_G)	l/s	Outflux, pump 1
alpha	Jout/Jin		Transmission probability

MESH 1

- 1 In the **Model Builder** window, under **Component 1 (comp1)** click **Mesh 1**.
- 2 In the **Settings** window for **Mesh**, locate the **Physics-Controlled Mesh** section.
- 3 From the **Element size** list, choose **Fine**.
- 4 Click  **Build All**.

STUDY 1

In the **Study** toolbar, click  **Compute**.

RESULTS

Mirror 3D 1

- 1 In the **Results** toolbar, click  **More Datasets** and choose **Mirror 3D**.
- 2 In the **Settings** window for **Mirror 3D**, locate the **Plane Data** section.
- 3 From the **Plane** list, choose **ZX-planes**.

Now add a **Mirror 3D** dataset to visualize the entire geometry in results.

Incident Molecular Flux (fmf)

- 1 In the **Model Builder** window, under **Results** click **Incident Molecular Flux (fmf)**.
- 2 In the **Settings** window for **3D Plot Group**, locate the **Data** section.
- 3 From the **Dataset** list, choose **Mirror 3D 1**.
- 4 In the **Incident Molecular Flux (fmf)** toolbar, click  **Plot**.

Now evaluate the transmission probability.

Global Evaluation 1



- 1 In the **Results** toolbar, click  **Global Evaluation**.
- 2 In the **Settings** window for **Global Evaluation**, click **Replace Expression** in the upper-right corner of the **Expressions** section. From the menu, choose **Component 1 (comp1) > Definitions > Variables > alpha - Transmission probability - 1**.

3 Click  **Evaluate**.



COMPONENT I (COMPI)

Now add the mathematical particle tracing interface to compute the transmission probability with a Monte Carlo approach.

ADD PHYSICS

- 1 In the **Home** toolbar, click  **Add Physics** to open the **Add Physics** window.
- 2 Go to the **Add Physics** window.
- 3 In the tree, select **Mathematics** > **Mathematical Particle Tracing (pt)**.
- 4 Find the **Physics interfaces in study** subsection. In the table, clear the **Solve** checkbox for **Study 1**.
- 5 Click the **Add to Component I** button in the window toolbar.
- 6 In the **Home** toolbar, click  **Add Physics** to close the **Add Physics** window.

ADD STUDY

- 1 In the **Home** toolbar, click  **Add Study** to open the **Add Study** window.
- 2 Go to the **Add Study** window.
- 3 Find the **Studies** subsection. In the **Select Study** tree, select **General Studies** > **Time Dependent**.
- 4 Find the **Physics interfaces in study** subsection. In the table, clear the **Solve** checkbox for **Free Molecular Flow (fmf)**.
- 5 Click the **Add Study** button in the window toolbar.
- 6 In the **Home** toolbar, click  **Add Study** to close the **Add Study** window.

MATHEMATICAL PARTICLE TRACING (PT)

- 1 In the **Settings** window for **Mathematical Particle Tracing**, locate the **Particle Release and Propagation** section.
- 2 In the **Maximum number of secondary particles** text field, type 0.

GLOBAL DEFINITIONS

Parameters 1

- 1 In the **Model Builder** window, under **Global Definitions** click **Parameters 1**.
- 2 In the **Settings** window for **Parameters**, locate the **Parameters** section.

3 In the table, enter the following settings:

Name	Expression	Value	Description
M	Mw/N_A_const	4.6495E-26 kg	Particle mass

MATHEMATICAL PARTICLE TRACING (PT)

Particle Properties 1

- 1 In the **Model Builder** window, under **Component 1 (comp1) > Mathematical Particle Tracing (pt)** click **Particle Properties 1**.
- 2 In the **Settings** window for **Particle Properties**, locate the **Particle Mass** section.
- 3 In the m_p text field, type M.

Inlet 1

- 1 In the **Physics** toolbar, click  **Boundaries** and choose **Inlet**.
- 2 Select Boundary 1 only.
Release 10,000 particles uniformly spaced over the inlet boundary. Use the **Thermal** initial velocity to release the particles.
- 3 In the **Settings** window for **Inlet**, locate the **Initial Position** section.
- 4 From the **Initial position** list, choose **Projected plane grid**.
- 5 In the N text field, type 10000.
- 6 Locate the **Initial Velocity** section. From the **Velocity specification** list, choose **Thermal**.
- 7 In the T text field, type T0.

Thermal Reemission 1

- 1 In the **Physics** toolbar, click  **Boundaries** and choose **Thermal Reemission**.
- 2 In the **Settings** window for **Thermal Reemission**, locate the **Boundary Selection** section.
- 3 From the **Selection** list, choose **All boundaries**.
- 4 Locate the **Wall** section. In the T text field, type T0.

Thermal Reemission 2

- 1 In the **Physics** toolbar, click  **Boundaries** and choose **Thermal Reemission**.
- 2 Select Boundary 18 only.
- 3 In the **Settings** window for **Thermal Reemission**, locate the **Wall** section.
- 4 In the T text field, type T0.
- 5 In the γ text field, type frac.

Particle Counter 1

- 1 In the **Physics** toolbar, click  **Boundaries** and choose **Particle Counter**.
- 2 Select Boundary 18 only.
- 3 In the **Settings** window for **Particle Counter**, locate the **Particle Counter** section.
- 4 From the **Release feature** list, choose **Inlet I**.

Create a **Wall** boundary condition to contribute with the inlet boundary. This ensures that particles returning to the inlet will disappear.

Wall 2

- 1 In the **Physics** toolbar, click  **Boundaries** and choose **Wall**.
- 2 Select Boundary 1 only.
- 3 In the **Settings** window for **Wall**, locate the **Wall Condition** section.
- 4 From the **Wall condition** list, choose **Disappear**.

Create a bounce **Wall** boundary condition to provide a symmetry condition.

Wall 3

- 1 In the **Physics** toolbar, click  **Boundaries** and choose **Wall**.
- 2 Select Boundaries 2 and 5 only.

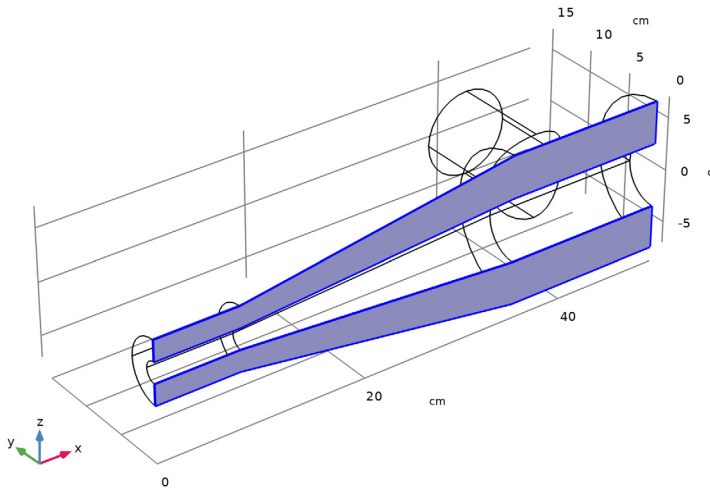

- 3 In the **Settings** window for **Wall**, locate the **Wall Condition** section.
- 4 From the **Wall condition** list, choose **Bounce**.

COMPONENT 1 (COMP1)

In order to obtain an accurate solution, a very fine mesh should be used. Since the only degrees of freedom correspond to the particles, using a very fine mesh does not significantly add to the computational burden.

MESH 2

- 1 In the **Mesh** toolbar, click **Add Mesh** and choose **Add Mesh**.
- 2 In the **Settings** window for **Mesh**, locate the **Physics-Controlled Mesh** section.
- 3 From the **Element size** list, choose **Extra fine**.
- 4 Click  **Build All**.

The solver settings for the particle tracing need to be quite strict in order to obtain an accurate transmission probability. The initial time step should be very small in comparison to the total simulation time and the maximum time step should be small enough to accurately resolve the particle trajectories.



STUDY 2

Step 1: Time Dependent

- 1 In the **Model Builder** window, under **Study 2** click **Step 1: Time Dependent**.
- 2 In the **Settings** window for **Time Dependent**, locate the **Study Settings** section.
- 3 In the **Output times** text field, type range (0,0.03/49,0.03).
- 4 Click to expand the **Mesh Selection** section. In the table, enter the following settings:

Component	Mesh
Component 1	Mesh 2

Solution 2 (sol2)

- 1 In the **Study** toolbar, click  **Show Default Solver**.
- 2 In the **Model Builder** window, expand the **Solution 2 (sol2)** node, then click **Time-Dependent Solver 1**.
- 3 In the **Settings** window for **Time-Dependent Solver**, click to expand the **Time Stepping** section.
- 4 Select the **Initial step** checkbox. In the associated text field, type 1e-8.
- 5 From the **Maximum step constraint** list, choose **Constant**.
- 6 In the **Maximum step** text field, type 1e-4.
- 7 In the **Study** toolbar, click  **Compute**.



RESULTS

Particle Trajectories (pt)

After the study is complete, a **Warning** node may appear in the solver sequence, indicating that some particles have been removed from the simulation because an intersection point with the boundary was not found. This occasionally happens because of the discretization of the chamber walls using the finite element mesh, which is an imperfect representation of cylindrical and conical boundaries. Usually the number of removed particles is very small compared to the total number of particles and can safely be ignored.

If it is absolutely necessary to prevent any particles from disappearing in this manner, you can reduce the probability of particles failing to detect boundary intersections by further refining the mesh. Also consider selecting **Linear** from the **Geometry shape order** list in the **Component 1** settings; linear shape order is more robust than the default shape order, which is mostly quadratic, at the expense of some accuracy.

Global Evaluation 2

- 1 In the **Results** toolbar, click  **Global Evaluation**.
- 2 In the **Settings** window for **Global Evaluation**, locate the **Data** section.
- 3 From the **Dataset** list, choose **Study 2/Solution 2 (sol2)**.
- 4 From the **Time selection** list, choose **Last**.
- 5 Click **Replace Expression** in the upper-right corner of the **Expressions** section. From the menu, choose **Component 1 (comp1) > Mathematical Particle Tracing > Particle Counter 1 > pt.pcnt1.alpha - Transmission probability - 1**.
- 6 Click  **Evaluate**.

The transmission probability from the particle tracing approach agrees very well with the result from the **Free Molecular Flow** interface.