



Model created in COMSOL Multiphysics 6.4

# Laminar Modular Mixer – Template File

This model is a template MPH file used by the laminar case of the [Modular Mixer](#) models. The geometry is a combination of a Rushton impeller and a flat bottom tank. The geometry subsequences to build the impeller and vessel are imported from the Part Libraries.

---

**Application Library path:** Mixer\_Module/Tutorials/modular\_mixer\_geom

---

### *Modeling Instructions*

---

#### **ADD COMPONENT**

In the **Home** toolbar, click  **Add Component** and choose **3D**.

#### **GLOBAL DEFINITIONS**

##### *Parameters 1*

- 1 In the **Model Builder** window, under **Global Definitions** click **Parameters 1**.
- 2 In the **Settings** window for **Parameters**, locate the **Parameters** section.
- 3 In the table, enter the following settings:

<b>Name</b>	<b>Expression</b>	<b>Value</b>	<b>Description</b>
H	0.0805[m]	0.0805 m	Vessel height
T	H	0.0805 m	Vessel diameter
C	1/3*H	0.026833 m	Clearance
B	4	4	Number of baffles
bw	T/10	0.00805 m	Baffle width
Da	1/3*T	0.026833 m	Impeller diameter
shaft_diameter	1/10*Da	0.0026833 m	Shaft diameter
blade_length	Da/4	0.0067083 m	Blade length for Rushton turbine
blade_width	Da/5	0.0053667 m	Width of impeller blade

#### **PART LIBRARIES**

- 1 In the **Geometry** toolbar, click  **Part Libraries**.
- 2 In the **Model Builder** window, under **Component 1 (comp1)** click **Geometry 1**.

- 3 In the **Part Libraries** window, select **Mixer Module > Impellers, Surface Blade Representation > Impellers, Radial > rushton\_impeller** in the tree.
- 4 Click  **Add to Geometry**.

## GEOMETRY I

### *Rushton Impeller I (pi1)*

- 1 In the **Model Builder** window, under **Component 1 (comp1) > Geometry 1** click **Rushton Impeller I (pi1)**.
- 2 In the **Settings** window for **Part Instance**, locate the **Input Parameters** section.
- 3 In the table, enter the following settings:

Name	Expression	Value	Description
d_hu	shaft_diameter+Da/20	0.004025 m	Diameter of impeller hub
l_ib	blade_length	0.0067083 m	Length of the impeller blades
w_ib	blade_width	0.0053667 m	Width of the impeller blade
d_id	Da-2*(blade_length*3/4)	0.016771 m	Disk diameter for Rushton and Smith turbines
d_im	Da	0.026833 m	Impeller diameter
hp_im	-blade_width/2	-0.0026833 m	Position of the lowest part of the impeller hub or impeller shaft along the z-axis
d_is	shaft_diameter	0.0026833 m	Diameter of impeller shaft

- 4 Click to expand the **Object Selections** section. Click **New Cumulative Selection**.
- 5 In the **New Cumulative Selection** dialog, type **Impeller Domains** in the **Name** text field.
- 6 Click **OK**.
- 7 In the table, enter the following settings:

Name	Contribute to
Impeller	Impeller Domains
Tank	None

- 8 In the **Settings** window for **Part Instance**, click to expand the **Boundary Selections** section.

9 Click **New Cumulative Selection**.

10 In the **New Cumulative Selection** dialog, type Rotating Interior Wall in the **Name** text field.

11 Click **OK**.

12 In the **Settings** window for **Part Instance**, locate the **Boundary Selections** section.

13 Click **New Cumulative Selection**.

14 In the **New Cumulative Selection** dialog, type Rotating Wall in the **Name** text field.

15 Click **OK**.

16 In the table, enter the following settings:

<b>Name</b>	<b>Contribute to</b>
Impeller blades	Rotating Interior Wall
Impeller disk	Rotating Interior Wall
Impeller hub	Rotating Wall
Surfaces to hide	None
Control surface upper	None
Control surface lower	None
Control surface side	None

17 In the **Settings** window for **Part Instance**, click to expand the **Edge Selections** section.

18 Click **New Cumulative Selection**.

19 In the **New Cumulative Selection** dialog, type Remove Edges in the **Name** text field.

20 Click **OK**.

21 In the table, enter the following settings:

<b>Name</b>	<b>Contribute to</b>
Edges to remove	Remove Edges

22 In the **Settings** window for **Part Instance**, locate the **Selection Settings** section.

23 Select the **Keep noncontributing selections** checkbox.

## PART LIBRARIES

1 In the **Geometry** toolbar, click  **Part Libraries**.

2 In the **Model Builder** window, click **Geometry I**.

3 In the **Part Libraries** window, select **Mixer Module > Shafts > impeller\_shaft** in the tree.

4 Click  **Add to Geometry**.

## GEOMETRY I

### *Impeller Shaft I (pi2)*

- 1 In the **Model Builder** window, under **Component 1 (comp1) > Geometry 1** click **Impeller Shaft I (pi2)**.
- 2 In the **Settings** window for **Part Instance**, locate the **Input Parameters** section.
- 3 In the table, enter the following settings:

Name	Expression	Value	Description
hp_im	-blade_width/2	-0.0026833 m	Position of the lowest part of the impeller hub or impeller shaft along the z-axis
d_is	shaft_diameter	0.0026833 m	Impeller shaft diameter
l_is	H-C+blade_width	0.059033 m	Impeller shaft length

4 Click to expand the **Object selections** section. In the table, enter the following settings:

Name	Contribute to
Impeller	Impeller Domains

5 Click to expand the **Boundary selections** section. In the table, enter the following settings:

Name	Contribute to
Exterior	None
Impeller	Rotating Wall

6 Click to expand the **Edge selections** section. In the table, enter the following settings:

Name	Contribute to
Edges to remove	Remove Edges
Impeller	None



7 Locate the **Selection Settings** section. Select the **Keep noncontributing selections** checkbox.

### *Union I (uni1)*

1 In the **Geometry** toolbar, click  **Booleans and Partitions** and choose **Union**.

- 2 Click in the **Graphics** window and then press Ctrl+A to select both objects.
- 3 In the **Settings** window for **Union**, locate the **Union** section.
- 4 From the **Repair tolerance** list, choose **Relative**.

## PART LIBRARIES

- 1 In the **Geometry** toolbar, click  **Part Libraries**.
- 2 In the **Model Builder** window, click **Geometry 1**.
- 3 In the **Part Libraries** window, select **Mixer Module > Tanks > flat\_bottom\_tank** in the tree.
- 4 Click  **Add to Geometry**.

## GEOMETRY 1

### *Flat Bottom Tank 1 (pi3)*

- 1 In the **Model Builder** window, under **Component 1 (comp1) > Geometry 1** click **Flat Bottom Tank 1 (pi3)**.
- 2 In the **Settings** window for **Part Instance**, locate the **Position and Orientation of Output** section.
- 3 Find the **Rotation** subsection. In the **Rotation angle** text field, type 90.
- 4 Locate the **Input Parameters** section. In the table, enter the following settings:

Name	Expression	Value	Description
n_ba	B	4	Number of baffles
w_ba	bw	0.00805 m	Baffle width
d_im	Da	0.026833 m	Impeller diameter
d_ta	T	0.0805 m	Tank diameter
h_ta	H	0.0805 m	Tank height
hp_ta	-C	-0.026833 m	Height position, cylindrical surface
rf_ta	0	0 m	Fillet radius of lower tank edge
t_ta	0	0 m	Thickness of tank wall
t_ba	0	0 m	Thickness of tank baffles

- 5 Locate the **Boundary Selections** section. Click **New Cumulative Selection**.
- 6 In the **New Cumulative Selection** dialog, type **Symmetry** in the **Name** text field.
- 7 Click **OK**.
- 8 In the **Settings** window for **Part Instance**, locate the **Boundary Selections** section.
- 9 Click **New Cumulative Selection**.

- 10 In the **New Cumulative Selection** dialog, type Tank Walls in the **Name** text field.
- 11 Click **OK**.
- 12 In the **Settings** window for **Part Instance**, locate the **Boundary Selections** section.
- 13 Click **New Cumulative Selection**.
- 14 In the **New Cumulative Selection** dialog, type Interior Walls in the **Name** text field.
- 15 Click **OK**.
- 16 In the **Settings** window for **Part Instance**, locate the **Boundary Selections** section.
- 17 Click **New Cumulative Selection**.
- 18 In the **New Cumulative Selection** dialog, type View Suppression in the **Name** text field.
- 19 Click **OK**.
- 20 Click to expand the **Boundary selections** section. In the table, enter the following settings:

<b>Name</b>	<b>Contribute to</b>
Tank	None
Baffles	Interior Wall
Fluid surface	Symmetry
Tank walls	Tank Walls
Surfaces to hide	View suppression
Exterior	None

- 21 In the **Settings** window for **Part Instance**, locate the **Selection Settings** section.
- 22 Select the **Keep noncontributing selections** checkbox.

#### *Fluid Domain*

- 1 In the **Geometry** toolbar, click  **Booleans and Partitions** and choose **Difference**.
- 2 In the **Settings** window for **Difference**, type Fluid Domain in the **Label** text field.
- 3 Locate the **Difference** section. From the **Objects to add** list, choose **All (Flat Bottom Tank 1)**.
- 4 From the **Objects to subtract** list, choose **Impeller Domains**.
- 5 From the **Repair tolerance** list, choose **Relative**.
- 6 Locate the **Selections of Resulting Entities** section. Select the **Resulting objects selection** checkbox.
- 7 From the **Show in physics** list, choose **All levels**.

### Flat Pressure Point

- 1 In the **Geometry** toolbar, click  **Selections** and choose **Explicit Selection**.
- 2 In the **Settings** window for **Explicit Selection**, type Flat Pressure Point in the **Label** text field.
- 3 Locate the **Entities to Select** section. From the **Geometric entity level** list, choose **Point**.
- 4 On the object **dif1**, select Point 34 only.

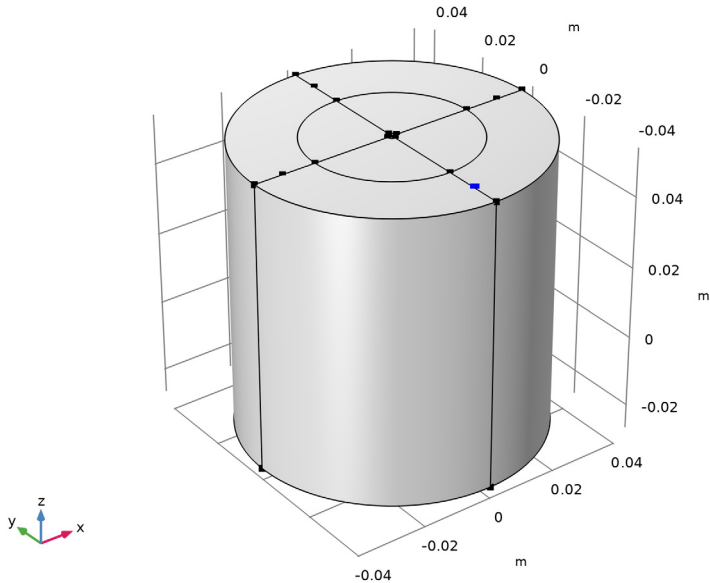

- 5 Locate the **Resulting Selection** section. Find the **Cumulative selection** subsection. Click **New**.
- 6 In the **New Cumulative Selection** dialog, type Pressure Point Constraint in the **Name** text field.
- 7 Click **OK**.

### Edges to Remove

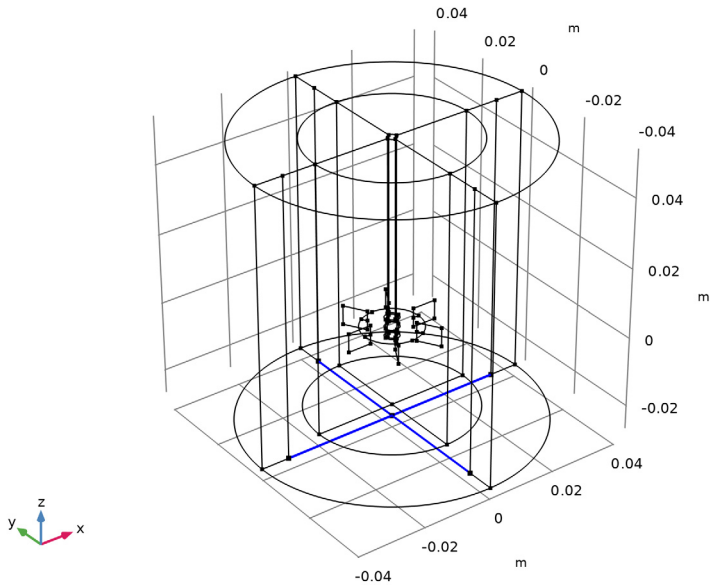

- 1 In the **Geometry** toolbar, click  **Selections** and choose **Explicit Selection**.
- 2 In the **Settings** window for **Explicit Selection**, type Edges to Remove in the **Label** text field.
- 3 Locate the **Entities to Select** section. From the **Geometric entity level** list, choose **Edge**.

4 On the object **dif1**, select Edges 9, 61, 78, and 79 only.





5 Locate the **Resulting Selection** section. Find the **Cumulative selection** subsection. From the **Contribute to** list, choose **Remove Edges**.

#### *Rotating Fluid Domain*



- 1 In the **Geometry** toolbar, click  **Selections** and choose **Explicit Selection**.
- 2 Click the  **Zoom Extents** button in the **Graphics** toolbar.
- 3 On the object **dif1**, select Domain 2 only.
- 4 In the **Settings** window for **Explicit Selection**, type Rotating Fluid Domain in the **Label** text field.

#### *Ignore Edges 1 (ige1)*

- 1 In the **Geometry** toolbar, click  **Virtual Operations** and choose **Ignore Edges**.
- 2 In the **Settings** window for **Ignore Edges**, locate the **Input** section.
- 3 From the **Edges to ignore** list, choose **Remove Edges**.
- 4 Clear the **Ignore adjacent vertices** checkbox.
- 5 In the **Geometry** toolbar, click  **Build All**.

Create a selection of all walls. Use **Wireframe Rendering** to make interior walls visible, too.

*Union Selection: All Walls*

- 1 In the **Geometry** toolbar, click  **Selections** and choose **Union Selection**.
- 2 In the **Settings** window for **Union Selection**, type Union Selection: All Walls in the **Label** text field.
- 3 Locate the **Geometric Entity Level** section. From the **Level** list, choose **Boundary**.
- 4 Locate the **Input Entities** section. Click  **Add**.
- 5 In the **Add** dialog, in the **Selections to add** list, choose **Rotating Interior Wall**, **Rotating Wall**, **Tank Walls**, and **Interior Walls**.
- 6 Click **OK**.

The model geometry is now complete.