



Model created in COMSOL Multiphysics 6.4

Viscous Catenary

Introduction

The word catenary is derived from the Latin word *catena*, which means chain. The catenary is the geometrical shape that corresponds to the curve followed by an idealized chain or cable supported at both ends and hanging under its own weight. This shape played an important role in the history of mathematics and physics, highlighting the relationships that occur between geometry and mechanics. It is also important in structural engineering. Robert Hooke first realized that the shape represents the optimal form of an arch of constant cross section and this discovery was likely employed by Christopher Wren in the rebuilding of St Paul's Cathedral in London. Despite announcing his achievement to the Royal Society in 1671 and publishing it in an encrypted form as a Latin anagram in 1675, the anagram's meaning was not revealed until after Hooke's executor published it posthumously in 1705. Although aware that the catenary shape was not a parabola, Hooke could not derive its mathematical form. This was ultimately discovered independently by Gottfried Leibniz, Christiaan Huygens, and Johann Bernoulli in response to a challenge issued by Jakob Bernoulli in 1690.

The viscous catenary problem describes the motion of a cylinder of highly viscous fluid, supported at its ends as it flows under gravity. In the last decade this problem has generated significant theoretical and experimental interest in the academic community. Solutions to the problem in one dimension have been derived ([Ref. 1](#) and [Ref. 2](#)). The rich phenomena that occur in this apparently simple problem are industrially important in a range of applications such as filament spinning and glass manufacture.

Model Definition

The model consists of a cylinder of Newtonian fluid, with initial diameter 0.6 mm and length 21.5 mm, falling under its own weight. The fluid density is 1000 kg/m^3 and its viscosity is 100 Pa·s. The surface tension of the fluid is 22 mN/m. The capillary number of the flow is high, so the contact angle of the fluid with the supporting surfaces is unimportant — here a nominal value of 90° is used. At the surfaces of the cylinder, the Navier slip boundary condition is used, this means that the supporting edges of the cylinder can move slightly. This displacement is small compared to the overall displacement of the catenary, and can be subtracted from the results if necessary.

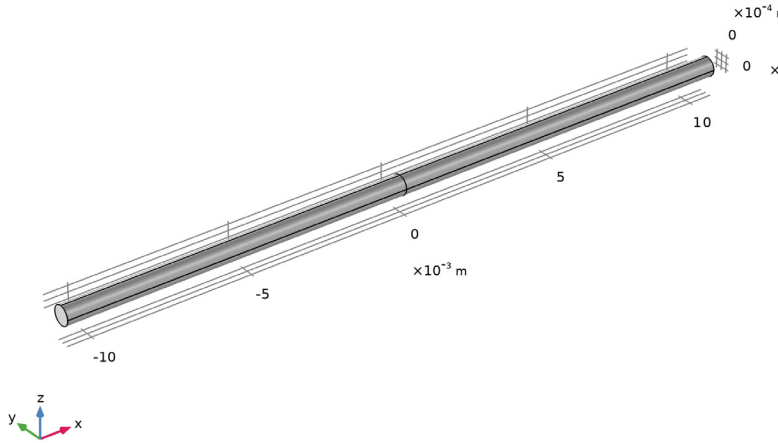

Figure 1: Model geometry.

The model geometry is shown in [Figure 1](#). The cylinder is split into two halves to set up points at its center that can be used to compute the height of the lowest point on the catenary.

Results and Discussion

[Figure 2](#) shows the fluid velocity within the catenary after 2 s of falling. The arrows show that the fluid velocity is predominantly vertical. The pressure within the catenary is shown in [Figure 3](#). The pressure variations occur mainly in the small region adjacent to the anchors, where the radius of curvature of the surface is greatest. The deformed mesh is shown in [Figure 4](#). The mesh deformation is large in the region close to the anchor, and the mesh quality is consequently undesirably low. Ideally the model should be stopped at approximately 1 s and a re-meshed before the solver is allowed to run on.

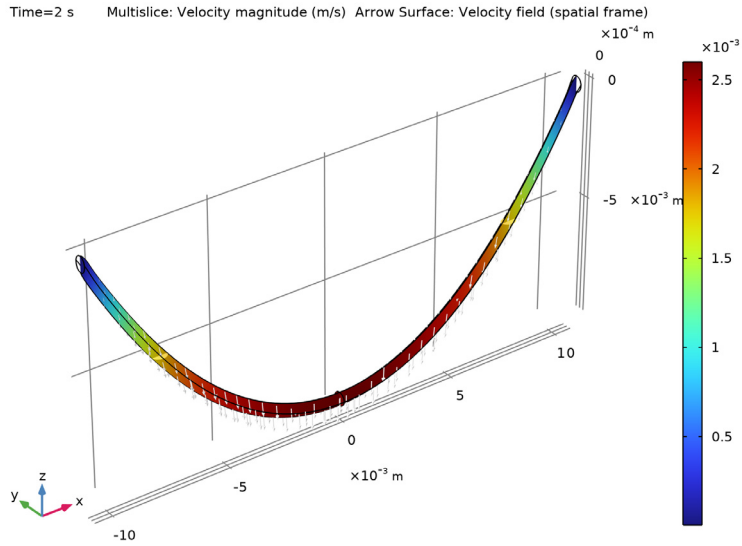

Figure 2: Velocity in the center plane of the catenary after 2s.

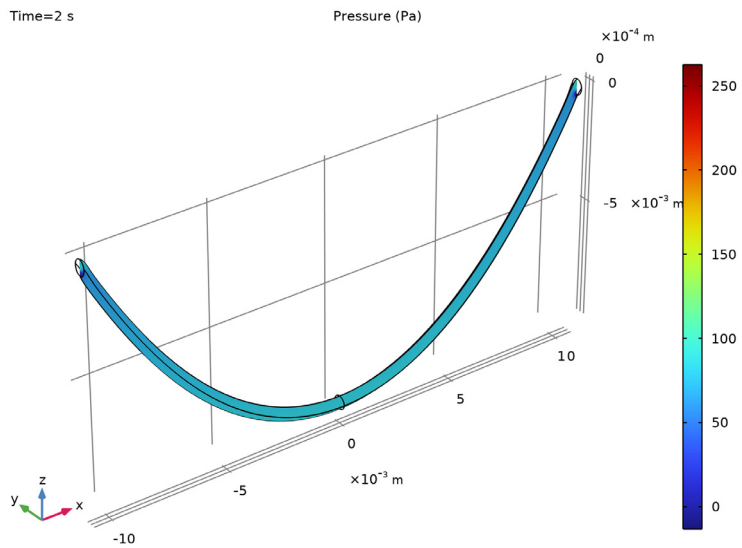

Figure 3: Pressure in the center plane of the catenary after 2 s.

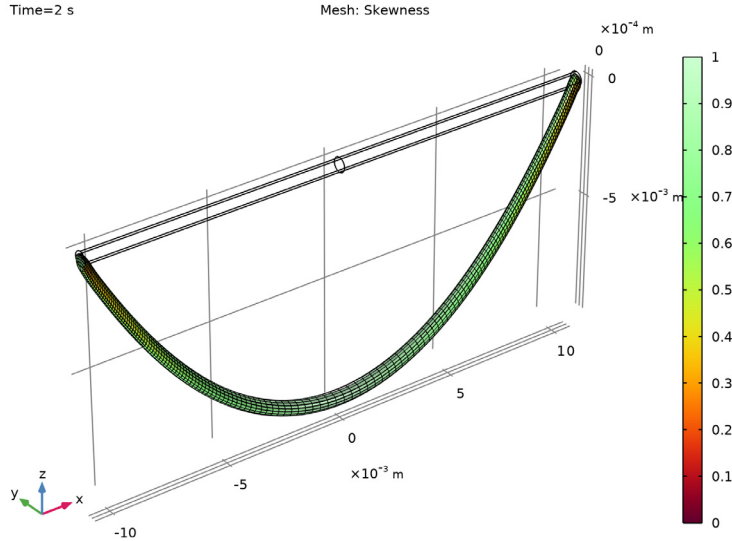

Figure 4: Plot showing the deformed mesh after 2 s. The mesh quality in the regions adjacent to the anchors is undesirably low.

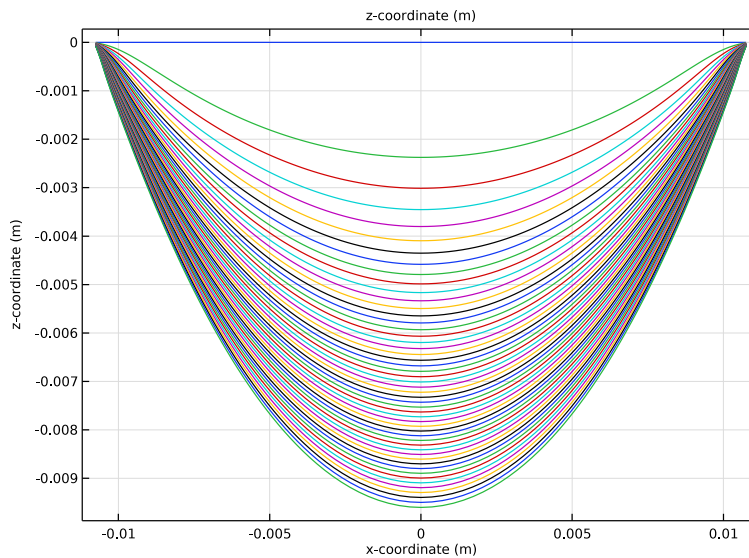

Figure 5: Plot showing the position of the centerline of the catenary at 0.02 s intervals during the simulation.

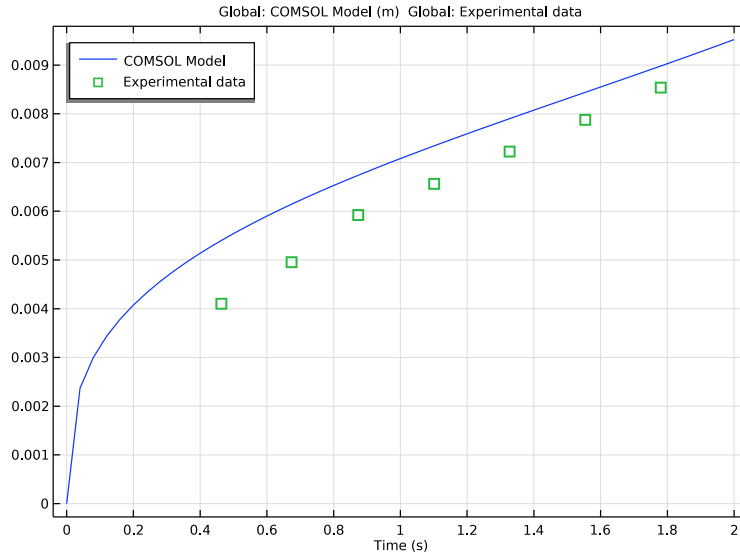

Figure 6: Displacement of the center of the catenary, relative to the anchors, as a function of time. The results are compared to experimental data from Ref. 2, which has an estimated error of approximately 15% (not shown in the plot).

Figure 5 shows the location of the midplane of the catenary as a function of time. The parabolic profile of the catenary for the central part of its length is clearly apparent. This is predicted by the 1-dimensional theory for intermediate time scales (in this model these occur after approximately 0.1 s; see Ref. 1 and Ref. 2).

Figure 6 shows the vertical distance between the midpoint of the catenary and its anchors, as a function of time. This is compared with experimental data from Ref. 2. The agreement between the two datasets is within experimental error, without the scaling factor employed by the authors to obtain agreement with their theory. An additional parametric sweep performed on the surface tension coefficient shows that the surface tension is related to this scaling factor (surface tension was neglected in the theoretical treatments of Ref. 1 and Ref. 2). This example shows how COMSOL can provide fundamental insights into complex problems — having the flexibility to solve the problem without assumptions can give valuable insight into validity of assumptions made in simpler, lower-dimensional models.

References

1. J. Teichman and L. Mahadevan, “The Viscous Catenary,” *J. Fluid Mech.*, vol. 478, pp. 71–80, 2003.
2. J.P. Koulakis, C.D. Mitescu, F. Bouchard-Wyart, P.-G. De Gennes, and E. Guyon, “The Viscous Catenary Revisited: Experiments and Theory,” *J. Fluid Mech.*, vol. 609, pp. 87–110, 2008.

Application Library path: Microfluidics_Module/Two-Phase_Flow/
viscous_catenary



Modeling Instructions

From the **File** menu, choose **New**.

NEW

In the **New** window, click  **Model Wizard**.

MODEL WIZARD

- 1 In the **Model Wizard** window, click  **3D**.
- 2 In the **Select Physics** tree, select **Fluid Flow > Multiphase Flow > Two-Phase Flow, Moving Mesh > Laminar Two-Phase Flow, Moving Mesh**.
- 3 Click **Add**.
- 4 Click  **Study**.
- 5 In the **Select Study** tree, select **General Studies > Time Dependent**.
- 6 Click  **Done**.
Set up the model parameters.

GLOBAL DEFINITIONS

Parameters 1



- 1 In the **Model Builder** window, under **Global Definitions** click **Parameters 1**.
- 2 In the **Settings** window for **Parameters**, locate the **Parameters** section.

3 In the table, enter the following settings:

Name	Expression	Value	Description
D0	0.6[mm]	6E-4 m	Initial diameter
L0	21.5[mm]	0.0215 m	Initial length
rho0	1000[kg/m^3]	1000 kg/m ³	Fluid density
mu0	100[Pa*s]	100 Pa·s	Fluid viscosity
sigma0	22[mN/m]	0.022 N/m	Surface tension coefficient

Set up an interpolating function for the results of Koulakis and others [Ref. 2](#).

Interpolation 1 (int1)

- 1 In the **Home** toolbar, click  **Functions** and choose **Global > Interpolation**.
- 2 In the **Settings** window for **Interpolation**, locate the **Definition** section.
- 3 From the **Data source** list, choose **File**.
- 4 Click  **Browse**.
- 5 Browse to the model's Application Libraries folder and double-click the file `viscous_catenary_data.txt`.
- 6 Click  **Import**.
- 7 Locate the **Interpolation and Extrapolation** section. From the **Extrapolation** list, choose **Specific value**.
- 8 In the **Value outside range** text field, type NaN.
This prevents COMSOL from extrapolating the experimental data beyond its range.
- 9 Locate the **Units** section. In the **Argument** table, enter the following settings:

Argument	Unit
t	s

- 10 In the **Function** table, enter the following settings:

Function	Unit
int1	m



Define the model geometry.

GEOMETRY I

Cylinder 1 (cyl1)

- 1 In the **Geometry** toolbar, click  **Cylinder**.
- 2 In the **Settings** window for **Cylinder**, locate the **Size and Shape** section.
- 3 In the **Radius** text field, type $D0/2$.
- 4 In the **Height** text field, type $L0$.
- 5 Locate the **Position** section. In the **x** text field, type $-L0/2$.
- 6 Locate the **Axis** section. From the **Axis type** list, choose **Cartesian**.
- 7 In the **x** text field, type 1.
- 8 In the **z** text field, type 0.
- 9 Click to expand the **Layers** section. In the table, enter the following settings:

Layer name	Thickness (m)
Layer 1	$L0/2$

- 10 Select the **Layers on bottom** checkbox.
- 11 Clear the **Layers on side** checkbox.
- 12 Click  **Build All Objects**.
- 13 Click the  **Zoom Extents** button in the **Graphics** toolbar.

Set up integration component couplings to evaluate the displacement at a point in the results processing.

DEFINITIONS

Integration 1 (intop1)

- 1 In the **Definitions** toolbar, click  **Nonlocal Couplings** and choose **Integration**.
- 2 In the **Settings** window for **Integration**, locate the **Source Selection** section.
- 3 From the **Geometric entity level** list, choose **Point**.
- 4 Select Point 1 only.

Integration 2 (intop2)

- 1 In the **Definitions** toolbar, click  **Nonlocal Couplings** and choose **Integration**.
- 2 In the **Settings** window for **Integration**, locate the **Source Selection** section.
- 3 From the **Geometric entity level** list, choose **Point**.

4 Select Point 5 only.

Set the material properties to those defined in the **Parameters** section.

MATERIALS

Material 1 (mat1)

1 In the **Model Builder** window, under **Component 1 (comp1)** right-click **Materials** and choose **Blank Material**.

2 In the **Settings** window for **Material**, locate the **Material Contents** section.

3 In the table, enter the following settings:

Property	Variable	Value	Unit	Property group
Density	rho	rho0	kg/m ³	Basic
Dynamic viscosity	mu	mu0	Pa·s	Basic

LAMINAR FLOW (SPF)

1 In the **Model Builder** window, under **Component 1 (comp1)** click **Laminar Flow (spf)**.

2 In the **Settings** window for **Laminar Flow**, locate the **Physical Model** section.

3 Select the **Include gravity** checkbox.

The **Navier Slip** wall boundary condition should be used on boundaries that the two-phase contact touches. The **Translational velocity** of the wall is set to **Zero (Fixed wall)**.

Wall 1

1 In the **Model Builder** window, under **Component 1 (comp1)** > **Laminar Flow (spf)** click **Wall 1**.

2 In the **Settings** window for **Wall**, locate the **Boundary Condition** section.

3 From the **Wall condition** list, choose **Navier slip**.

4 Click to expand the **Wall Movement** section. From the **Translational velocity** list, choose **Zero (Fixed wall)**.

Use the **Free Surface** boundary condition to model the free surface of the fluid.

Free Surface 1

1 In the **Physics** toolbar, click  **Boundaries** and choose **Free Surface**.

2 Select Boundaries 2–5 and 7–10 only.

3 In the **Settings** window for **Free Surface**, locate the **Surface Tension** section.

- 4 From the **Surface tension coefficient** list, choose **User defined**. In the σ text field, type σ_0 .
Show more options and turn on the equation based contributions so a point constraint can be set on the mesh displacement.
- 5 Click the  **Show More Options** button in the **Model Builder** toolbar.
- 6 In the **Show More Options** dialog, in the tree, select the checkbox for the node **Physics > Equation Contributions**.
- 7 Click **OK**.

Pointwise Constraint 1

- 1 In the **Physics** toolbar, click  **Points** and choose **Pointwise Constraint**.
- 2 Select Points 2 and 10 only.
- 3 In the **Settings** window for **Pointwise Constraint**, locate the **Pointwise Constraint** section.
- 4 In the **Constraint expression** text field, type $y - Y$.
- 5 Click to expand the **Discretization** section. Find the **Base geometry** subsection. From the **Element order** list, choose **Linear**.

Add displacement boundary conditions for the mesh movement.

MOVING MESH

Deforming Domain 1

- 1 In the **Model Builder** window, under **Component 1 (comp1) > Moving Mesh** click **Deforming Domain 1**.
- 2 In the **Settings** window for **Deforming Domain**, locate the **Smoothing** section.
- 3 From the **Mesh smoothing type** list, choose **Winslow**.

Symmetry/Roller 1

- 1 In the **Moving Mesh** toolbar, click  **Symmetry/Roller**.
- 2 Select Boundaries 1 and 11 only.
Set up a swept mesh.

MESH 1

Free Quad 1

- 1 In the **Mesh** toolbar, click  **More Generators** and choose **Free Quad**.
- 2 Select Boundary 6 only.



Swept 1

In the **Mesh** toolbar, click  **Swept**.

Distribution 1

- 1 Right-click **Swept 1** and choose **Distribution**.
- 2 In the **Settings** window for **Distribution**, locate the **Distribution** section.
- 3 From the **Distribution type** list, choose **Predefined**.
- 4 In the **Number of elements** text field, type 80.
- 5 In the **Element ratio** text field, type 3.
- 6 Select the **Reverse direction** checkbox.

Size

- 1 In the **Model Builder** window, under **Component 1 (comp1) > Mesh 1** click **Size**.
- 2 In the **Settings** window for **Size**, locate the **Element Size** section.
- 3 From the **Calibrate for** list, choose **Fluid dynamics**.
- 4 From the **Predefined** list, choose **Coarser**.
- 5 Click  **Build All**.
- 6 Click the  **Zoom Extents** button in the **Graphics** toolbar.

STUDY 1

Step 1: Time Dependent

- 1 In the **Model Builder** window, under **Study 1** click **Step 1: Time Dependent**.
- 2 In the **Settings** window for **Time Dependent**, locate the **Study Settings** section.
- 3 In the **Output times** text field, type range (0,0.04,2).
- 4 In the **Study** toolbar, click  **Compute**.

RESULTS

Velocity (spf)

Reproduce the plot shown in [Figure 2](#).

Arrow Surface 1

- 1 Right-click **Velocity (spf)** and choose **Arrow Surface**.
- 2 In the **Settings** window for **Arrow Surface**, locate the **Coloring and Style** section.
- 3 From the **Color** list, choose **White**.
- 4 In the **Velocity (spf)** toolbar, click  **Plot**.

- 5 Click the  **Zoom Extents** button in the **Graphics** toolbar.
Reproduce the plot shown in [Figure 3](#).

Surface

- 1 In the **Model Builder** window, expand the **Pressure (spf)** node.
- 2 Right-click **Surface** and choose **Delete**. Click **Yes** to confirm.

Slice 1

- 1 Right-click **Pressure (spf)** and choose **Slice**.
- 2 In the **Settings** window for **Slice**, locate the **Expression** section.
- 3 In the **Expression** text field, type p.
- 4 Locate the **Plane Data** section. From the **Plane** list, choose **zx-planes**.
- 5 In the **Planes** text field, type 1.
- 6 In the **Pressure (spf)** toolbar, click  **Plot**.
Reproduce the plot shown in [Figure 4](#).

3D Plot Group 4

In the **Results** toolbar, click  **3D Plot Group**.

Mesh 1

- 1 Right-click **3D Plot Group 4** and choose **Mesh**.
- 2 In the **3D Plot Group 4** toolbar, click  **Plot**.
Reproduce the plot shown in [Figure 5](#).

1D Plot Group 5

In the **Results** toolbar, click  **1D Plot Group**.

Line Graph 1

- 1 Right-click **1D Plot Group 5** and choose **Line Graph**.
- 2 Select Edges 3 and 11 only.
- 3 In the **Settings** window for **Line Graph**, locate the **y-Axis Data** section.
- 4 In the **Expression** text field, type z.
- 5 Locate the **x-Axis Data** section. From the **Parameter** list, choose **Expression**.
- 6 In the **Expression** text field, type x.
- 7 In the **1D Plot Group 5** toolbar, click  **Plot**.
Reproduce the plot shown in [Figure 6](#).

ID Plot Group 6

- 1 In the **Results** toolbar, click  **ID Plot Group**.
- 2 In the **Settings** window for **ID Plot Group**, locate the **Legend** section.
- 3 From the **Position** list, choose **Upper left**.

Global 1

- 1 Right-click **ID Plot Group 6** and choose **Global**.
- 2 In the **Settings** window for **Global**, locate the **y-Axis Data** section.
- 3 In the table, enter the following settings:

Expression	Unit	Description
intop1(z) - intop2(z)	m	COMSOL Model

Global 2

- 1 In the **Model Builder** window, right-click **ID Plot Group 6** and choose **Global**.
- 2 In the **Settings** window for **Global**, locate the **y-Axis Data** section.
- 3 In the table, enter the following settings:

Expression	Unit	Description
int1(t)		Experimental data

- 4 Click to expand the **Coloring and Style** section. Find the **Line style** subsection. From the **Line** list, choose **None**.
- 5 From the **Width** list, choose **2**.
- 6 Find the **Line markers** subsection. From the **Marker** list, choose **Square**.
- 7 From the **Positioning** list, choose **Interpolated**.
- 8 In the **Number** text field, type 7.
- 9 In the **ID Plot Group 6** toolbar, click  **Plot**.