



Model created in COMSOL Multiphysics 6.4

Thermal Expansion in a MEMS Device

Introduction

The purpose of this model is to exemplify the use of the Material Library in COMSOL Multiphysics. This library contains more than 20,000 property functions for over 2600 materials. The larger part of these properties are mechanical and thermal properties for solid materials given as functions of temperature. You need the Material Library to build the model.

The example also shows how to set up a model of thermal expansion when the structure is constrained.

Note: This model requires the Material Library.

Thermal expansion is a common method used in the microscale to displace a part of a component, for example in an actuator.

Model Definition

The figure below shows the model geometry:

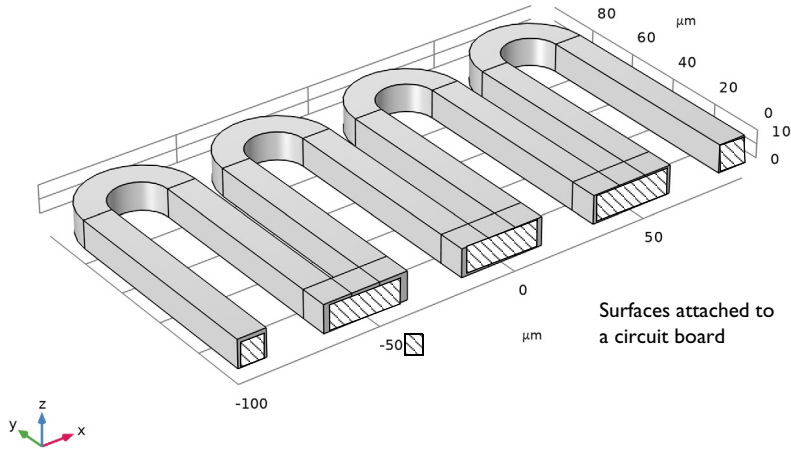

Figure 1: Geometry of the device.

The model consists of two sets of physics:

- A thermal balance with a heat source in the device, originating from Joule heating (ohmic heating). Air cooling is applied on the boundaries except at the position where the device is attached to a circuit board, where a thermal insulation condition is set.
- A force balance for the structural analysis with a volume load caused by thermal expansions. The device is fixed at the positions where it is attached to a circuit board (see [Figure 1](#)). The effect of possible thermal expansion for the circuit board is investigated.

The device is made of the copper-beryllium alloy UNS C17500, and the circuit board is made of FR4 material.

The thermal balance consists of a balance of flux at steady state. The heat flux is given by conduction only. The heat source is a constant heat source of $1 \cdot 10^8 \text{ W/m}^3$. The air cooling at the boundaries is expressed using a constant heat transfer coefficient of 10 W/m^2 and an ambient temperature of 298 K.

The expression for thermal expansion requires a strain reference temperature for the copper-beryllium alloy, which in this case is 298 K.

All other thermal and mechanical properties are obtained from the Material Library.

Results and Discussion

The following figure shows the temperature distribution in the device. The heat source increases the temperature to around 323.67 K from an ambient temperature of 298 K. The temperature varies less than 1/100 of a degree in the device.

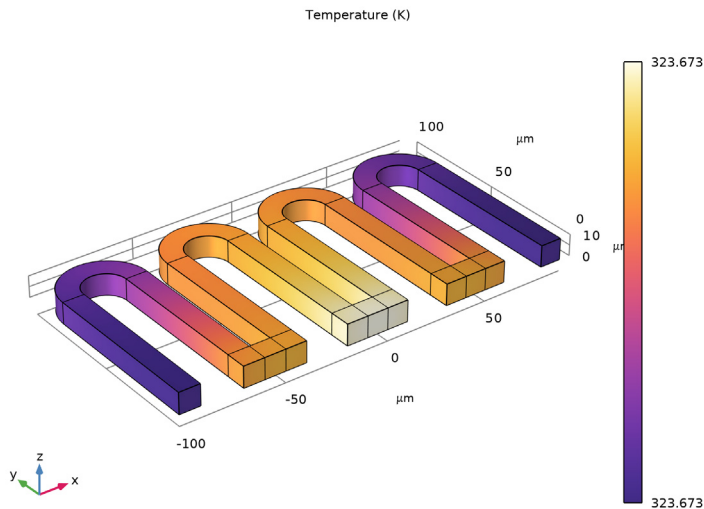

Figure 2: Temperature field in the device. The edges of the original geometry are shown in black. The deformed shape is exaggerated by a factor of 200.

The following figures show the stress field in the deformed device with fully constrained attachment boundaries (Figure 3), and with the expansion effect taken into account for the circuit board (Figure 4). The latter case leads to certain relaxation of the constraint applied to the device boundaries attached to the board. The resulting maximum von Mises stress becomes less by an order of magnitude. The stress is well within the elastic region for the material. The two latter solutions are juxtaposed in the same plot with common color range in Figure 5.

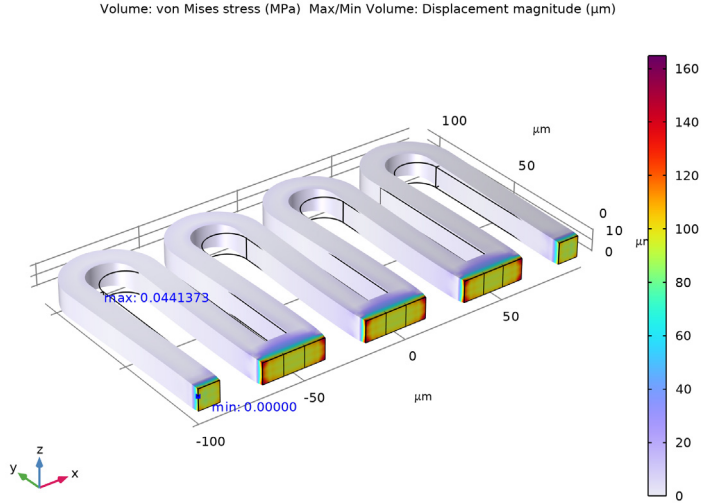

Figure 3: The von Mises stress in the deformed structure with fully constrained attachment boundaries. The edges of the original geometry are shown in black. The deformed shape is exaggerated by a factor of 200.

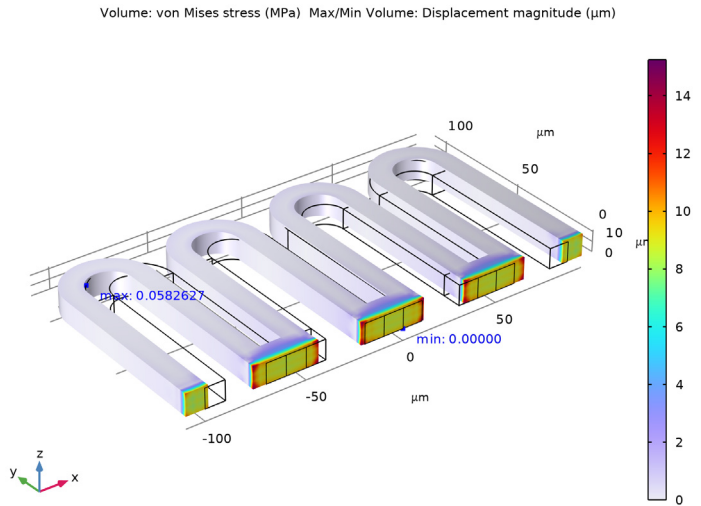

Figure 4: The von Mises stress in the deformed structure when the circuit board thermal expansion effect is modeled. The deformed shape is exaggerated by a factor of 200.

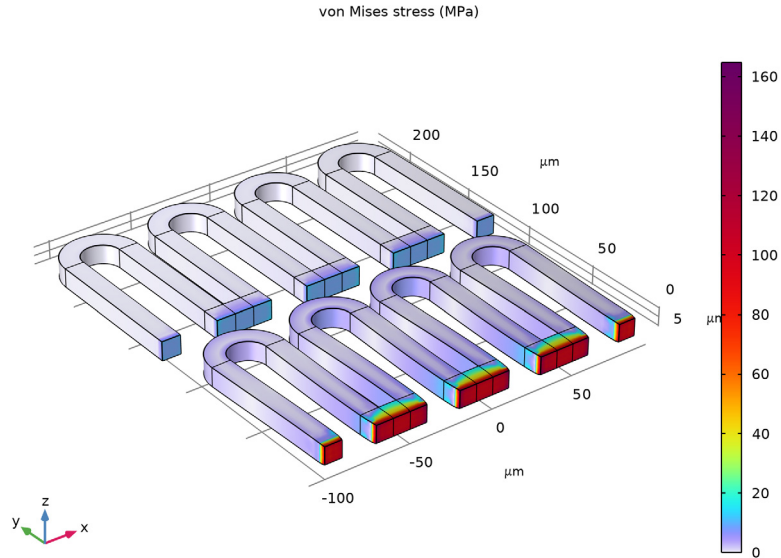



Figure 5: Comparison of the von Mises stress with and without thermal expansion effect in the circuit board modeled.

Application Library path: MEMS_Module/Sensors/thermal_expansion

Modeling Instructions



From the **File** menu, choose **New**.

NEW

In the **New** window, click  **Model Wizard**.

MODEL WIZARD

- 1 In the **Model Wizard** window, click  **3D**.
- 2 In the **Select Physics** tree, select **Structural Mechanics > Thermal-Structure Interaction > Thermal Stress, Solid**.
- 3 Click **Add**.

- 4 Click  **Study**.
- 5 In the **Select Study** tree, select **General Studies > Stationary**.
- 6 Click  **Done**.

GEOMETRY 1

Insert the geometry sequence.

- 1 In the **Geometry** toolbar, click **Insert Sequence** and choose **Insert Sequence**.
- 2 Browse to the model's Application Libraries folder and double-click the file `thermal_expansion_geom_sequence.mph`.
- 3 In the **Geometry** toolbar, click  **Build All**.

Complete geometry instructions can be found in the [Appendix — Geometry Modeling Instructions](#) section.

Next, create selections for use when defining the boundary conditions.

DEFINITIONS



Fixed

- 1 In the **Definitions** toolbar, click  **Box**.
- 2 In the **Settings** window for **Box**, type `Fixed` in the **Label** text field.
- 3 Locate the **Geometric Entity Level** section. From the **Level** list, choose **Boundary**.
- 4 Locate the **Box Limits** section. In the **y maximum** text field, type `1 [um]`.

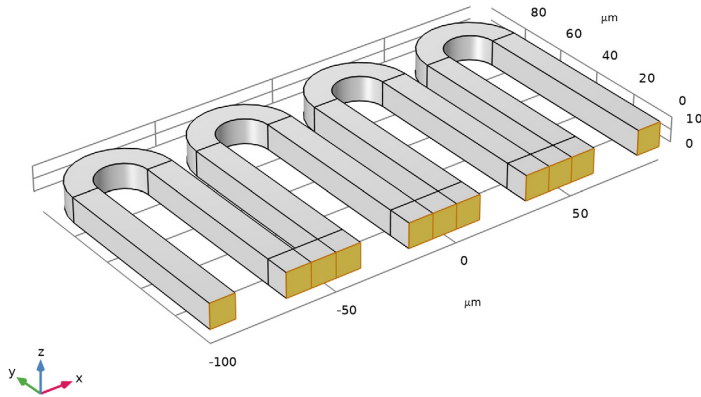
- 5 Locate the **Output Entities** section. From the **Include entity if** list, choose **Entity inside box**.



Heat Flux

- 1 In the **Definitions** toolbar, click  **Complement**.
- 2 In the **Settings** window for **Complement**, type Heat Flux in the **Label** text field.
- 3 Locate the **Geometric Entity Level** section. From the **Level** list, choose **Boundary**.
- 4 Locate the **Input Entities** section. Under **Selections to invert**, click  **Add**.
- 5 In the **Add** dialog, select **Fixed** in the **Selections to invert** list.

6 Click **OK**.

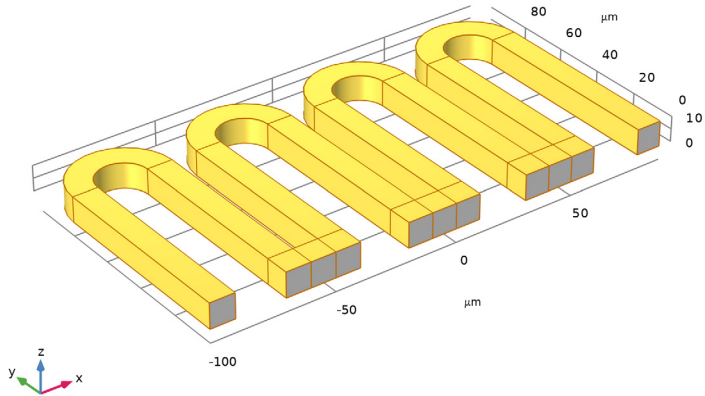



Top

- 1 In the **Definitions** toolbar, click  **Box**.
- 2 In the **Settings** window for **Box**, type **Top** in the **Label** text field.
- 3 Locate the **Geometric Entity Level** section. From the **Level** list, choose **Boundary**.
- 4 Locate the **Box Limits** section. In the **z minimum** text field, type 1 [um].

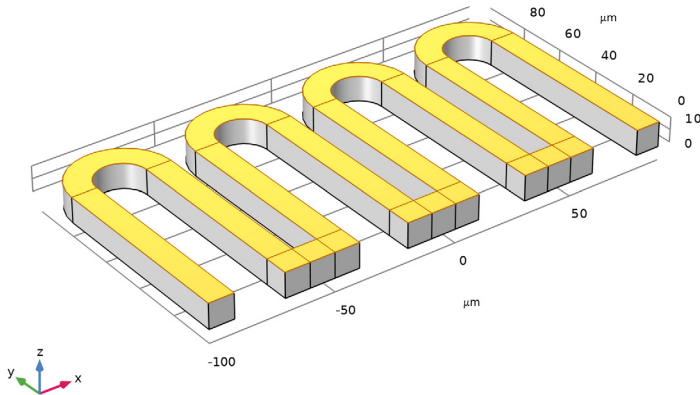
- 5 Locate the **Output Entities** section. From the **Include entity if** list, choose **Entity inside box**.



ADD MATERIAL

- 1 In the **Materials** toolbar, click  **Add Material** to open the **Add Material** window.
- 2 Go to the **Add Material** window.
- 3 In the tree, select **Material Library** > **Copper Alloys** > **UNS C17500** > **UNS C17500 [solid]**.
- 4 Click the **Add to Component** button in the window toolbar.
- 5 In the **Materials** toolbar, click  **Add Material** to close the **Add Material** window.

MULTIPHYSICS

Thermal Expansion 1 (tel)

- 1 In the **Settings** window for **Thermal Expansion**, locate the **Model Input** section.
- 2 Click  **Go to Source** for **Volume reference temperature**.

GLOBAL DEFINITIONS

Default Model Inputs

- 1 In the **Model Builder** window, under **Global Definitions** click **Default Model Inputs**.
- 2 In the **Settings** window for **Default Model Inputs**, locate the **Browse Model Inputs** section.

- 3 Find the **Expression for remaining selection** subsection. In the **Volume reference temperature** text field, type 298[K].

SOLID MECHANICS (SOLID)

Fixed Constraint I

- 1 In the **Physics** toolbar, click  **Boundaries** and choose **Fixed Constraint**.
- 2 In the **Settings** window for **Fixed Constraint**, locate the **Boundary Selection** section.
- 3 From the **Selection** list, choose **Fixed**.

HEAT TRANSFER IN SOLIDS (HT)

Heat Source I

- 1 In the **Physics** toolbar, click  **Domains** and choose **Heat Source**.
- 2 In the **Settings** window for **Heat Source**, locate the **Domain Selection** section.
- 3 From the **Selection** list, choose **All domains**.
- 4 Locate the **Heat Source** section. In the Q_0 text field, type 1e8.

Heat Flux I

- 1 In the **Physics** toolbar, click  **Boundaries** and choose **Heat Flux**.
- 2 In the **Settings** window for **Heat Flux**, locate the **Boundary Selection** section.
- 3 From the **Selection** list, choose **Heat Flux**.
- 4 Locate the **Heat Flux** section. From the **Flux type** list, choose **Convective heat flux**.
- 5 In the h text field, type 10.
- 6 In the T_{ext} text field, type 298.

MESH I

Mapped I

- 1 In the **Mesh** toolbar, click  **More Generators** and choose **Mapped**.
- 2 In the **Settings** window for **Mapped**, locate the **Boundary Selection** section.
- 3 From the **Selection** list, choose **Top**.



Size I

- 1 Right-click **Mapped I** and choose **Size**.
- 2 In the **Settings** window for **Size**, locate the **Element Size** section.
- 3 From the **Predefined** list, choose **Extremely fine**.
- 4 Click  **Build All**.

Swept 1

In the **Mesh** toolbar, click  **Swept**.

Distribution 1

- 1 Right-click **Swept 1** and choose **Distribution**.
- 2 In the **Settings** window for **Distribution**, locate the **Distribution** section.
- 3 In the **Number of elements** text field, type 3.
- 4 Click  **Build All**.
- 5 Click the  **Zoom Extents** button in the **Graphics** toolbar.

FIXED BOARD

- 1 In the **Model Builder** window, click **Study 1**.
- 2 In the **Settings** window for **Study**, type Fixed Board in the **Label** text field.
- 3 In the **Study** toolbar, click  **Compute**.

RESULTS

Stress (solid)

The first default plot shows the von Mises stress in the deformed material. Add markers to show the minimum and maximum displacement, and adjust the deformation scaling to reproduce the plot shown in [Figure 3](#).

Volume 1

- 1 In the **Model Builder** window, expand the **Stress (solid)** node, then click **Volume 1**.
- 2 In the **Settings** window for **Volume**, locate the **Expression** section.
- 3 From the **Unit** list, choose **MPa**.

Stress (solid)



In the **Model Builder** window, click **Stress (solid)**.

Max/Min Volume 1

- 1 In the **Stress (solid)** toolbar, click  **More Plots** and choose **Max/Min Volume**.
- 2 In the **Settings** window for **Max/Min Volume**, locate the **Coloring and Style** section.
- 3 From the **Color** list, choose **Blue**.

Deformation

- 1 In the **Model Builder** window, expand the **Results > Stress (solid) > Volume 1** node, then click **Deformation**.
- 2 In the **Settings** window for **Deformation**, locate the **Scale** section.

- 3 Select the **Scale factor** checkbox. In the associated text field, type 200.
- 4 In the **Stress (solid)** toolbar, click  **Plot**.
- 5 Click the  **Go to Default View** button in the **Graphics** toolbar.

Temperature (ht)

The second default plots shows the temperature field that should be similar to that displayed in [Figure 2](#).

- 1 In the **Model Builder** window, under **Results** click **Temperature (ht)**.
- 2 In the **Settings** window for **3D Plot Group**, click to expand the **Number Format** section.
- 3 Select the **Manual color legend settings** checkbox.
- 4 In the **Precision** text field, type 6.
- 5 In the **Temperature (ht)** toolbar, click  **Plot**.

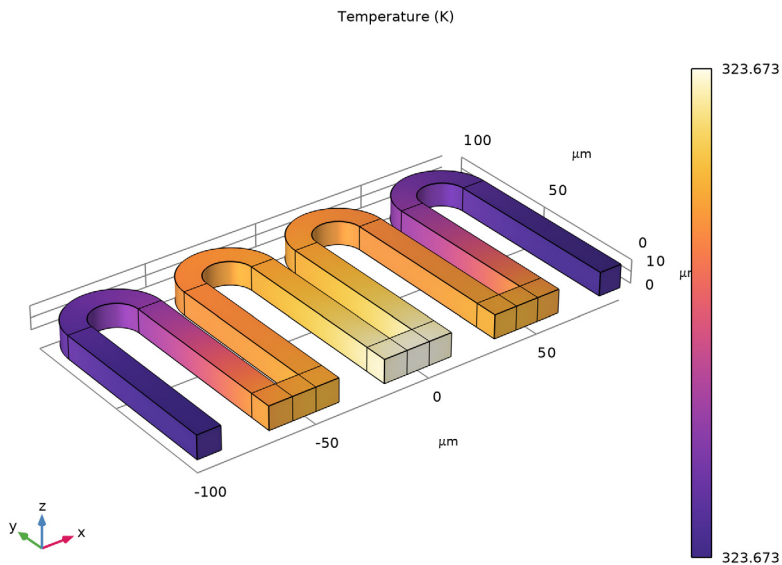

Next include the thermal expansion effect for the circuit board. First, add another material to represent it.

ADD MATERIAL

- 1 In the **Materials** toolbar, click  **Add Material** to open the **Add Material** window.
- 2 Go to the **Add Material** window.

- 3 In the tree, select **Built-in > FR4 (Circuit Board)**.
- 4 Right-click and choose **Add to Component 1 (comp1)**.
- 5 In the **Materials** toolbar, click  **Add Material** to close the **Add Material** window.

MATERIALS

FR4 (Circuit Board) (mat2)

- 1 In the **Settings** window for **Material**, locate the **Geometric Entity Selection** section.
- 2 From the **Geometric entity level** list, choose **Boundary**.
- 3 From the **Selection** list, choose **Fixed**.

Now add a **Thermal Expansion** subfeature to the **Fixed Constraint** feature, and define temperature and reference temperature as model inputs on boundaries.

SOLID MECHANICS (SOLID)

Fixed Constraint 1

In the **Model Builder** window, under **Component 1 (comp1) > Solid Mechanics (solid)** click **Fixed Constraint 1**.

Thermal Expansion 1

- 1 In the **Physics** toolbar, click  **Attributes** and choose **Thermal Expansion**.
- 2 In the **Settings** window for **Thermal Expansion**, locate the **Boundary Selection** section.
- 3 From the **Selection** list, choose **Fixed**.
- 4 Locate the **Model Input** section. Click  **Create Model Input** for **Volume reference temperature**.

SHARED PROPERTIES

Model Input 1

- 1 In the **Model Builder** window, under **Component 1 (comp1) > Definitions > Shared Properties** click **Model Input 1**.
- 2 In the **Settings** window for **Model Input**, locate the **Definition** section.
- 3 In the text field, type 298[K].

SOLID MECHANICS (SOLID)

Thermal Expansion 1

- 1 In the **Model Builder** window, under **Component 1 (comp1) > Solid Mechanics (solid) > Fixed Constraint 1** click **Thermal Expansion 1**.

- 2 In the **Settings** window for **Thermal Expansion**, locate the **Model Input** section.
- 3 Click  **Create Model Input** for **Temperature**.



SHARED PROPERTIES

Model Input 2

- 1 In the **Model Builder** window, under **Component 1 (comp1) > Definitions > Shared Properties** click **Model Input 2**.
- 2 In the **Settings** window for **Model Input**, locate the **Definition** section.
- 3 In the text field, type solid.T.

Add a second study for computation with board thermal expansion.

ADD STUDY

- 1 In the **Home** toolbar, click  **Add Study** to open the **Add Study** window.
- 2 Go to the **Add Study** window.
- 3 Find the **Studies** subsection. In the **Select Study** tree, select **General Studies > Stationary**.
- 4 Click the **Add Study** button in the window toolbar.
- 5 In the **Home** toolbar, click  **Add Study** to close the **Add Study** window.

EXPANDED BOARD

- 1 In the **Settings** window for **Study**, type Expanded Board in the **Label** text field.
- 2 Locate the **Study Settings** section. Clear the **Generate default plots** checkbox.
- 3 In the **Study** toolbar, click  **Compute**.

Group and duplicate the existing plots, then set them to the newly created dataset.

RESULTS

Stress (solid), Temperature (ht)

- 1 In the **Model Builder** window, under **Results**, Ctrl-click to select **Stress (solid)** and **Temperature (ht)**.
- 2 Right-click and choose **Group**.

Fixed Board

In the **Settings** window for **Group**, type Fixed Board in the **Label** text field.

Expanded Board

- 1 Right-click **Fixed Board** and choose **Duplicate**.

- 2 In the **Model Builder** window, click **Fixed Board 1**.
- 3 In the **Settings** window for **Group**, type **Expanded Board** in the **Label** text field.

Stress (solid) 1

- 1 In the **Model Builder** window, click **Stress (solid) 1**.
- 2 In the **Settings** window for **3D Plot Group**, locate the **Data** section.
- 3 From the **Dataset** list, choose **Expanded Board/Solution 2 (sol2)**.
- 4 In the **Stress (solid) 1** toolbar, click  **Plot**.

The computed stress field and deformation should be similar to that shown in [Figure 4](#).

Temperature (ht) 1

- 1 In the **Model Builder** window, click **Temperature (ht) 1**.
- 2 In the **Settings** window for **3D Plot Group**, locate the **Data** section.
- 3 From the **Dataset** list, choose **Expanded Board/Solution 2 (sol2)**.

Duplicate the first plot group to show both solutions in the same plot, like in [Figure 5](#).

Stress Comparison

- 1 In the **Model Builder** window, right-click **Stress (solid)** and choose **Duplicate**.
- 2 Right-click **Stress (solid) 2** and choose **Move Out**.
- 3 Right-click **Stress (solid) 2** and choose **Move Down**.
- 4 In the **Settings** window for **3D Plot Group**, type **Stress Comparison** in the **Label** text field.
- 5 Locate the **Plot Settings** section. Clear the **Plot dataset edges** checkbox.

Max/Min Volume 1

- 1 In the **Model Builder** window, expand the **Stress Comparison** node.
- 2 Right-click **Max/Min Volume 1** and choose **Delete**.

Line 1

- 1 In the **Model Builder** window, right-click **Stress Comparison** and choose **Line**.
- 2 In the **Settings** window for **Line**, locate the **Expression** section.
- 3 In the **Expression** text field, type 1.
- 4 Click to expand the **Title** section. From the **Title type** list, choose **None**.
- 5 Locate the **Coloring and Style** section. From the **Coloring** list, choose **Uniform**.
- 6 From the **Color** list, choose **Black**.
- 7 Click to expand the **Inherit Style** section. From the **Plot** list, choose **Volume 1**.

- 8 Clear the **Color** checkbox.
- 9 Clear the **Color and data range** checkbox.

Deformation 1

Right-click **Line 1** and choose **Deformation**.

Line 1, Volume 1

Right-click and choose **Duplicate**.

Volume 2

- 1 In the **Settings** window for **Volume**, locate the **Data** section.
- 2 From the **Dataset** list, choose **Expanded Board/Solution 2 (sol2)**.
- 3 Click to expand the **Title** section. From the **Title type** list, choose **None**.
- 4 Click to expand the **Inherit Style** section. From the **Plot** list, choose **Volume 1**.

Transformation 1

- 1 Right-click **Volume 2** and choose **Transformation**.
- 2 In the **Settings** window for **Transformation**, locate the **Transformation** section.
- 3 In the **Y** text field, type 120.



Line 2

- 1 In the **Model Builder** window, under **Results > Stress Comparison** click **Line 2**.
- 2 In the **Settings** window for **Line**, locate the **Data** section.
- 3 From the **Dataset** list, choose **Expanded Board/Solution 2 (sol2)**.

Transformation 1

- 1 Right-click **Line 2** and choose **Transformation**.
- 2 In the **Settings** window for **Transformation**, locate the **Transformation** section.
- 3 In the **Y** text field, type 120.
- 4 In the **Stress Comparison** toolbar, click  **Plot**.

Line 2

- 1 In the **Model Builder** window, click **Line 2**.
- 2 Click  **Plot**.
- 3 Click the  **Go to Default View** button in the **Graphics** toolbar.

Volume 1

- 1 In the **Model Builder** window, click **Volume 1**.
- 2 In the **Settings** window for **Volume**, locate the **Coloring and Style** section.

- 3 From the **Color table transformation** list, choose **Nonlinear**.
- 4 Set the **Color calibration parameter** value to **-1.5** to show better color resolution for low values.

Stress Comparison

- 1 In the **Model Builder** window, click **Stress Comparison**.
- 2 In the **Settings** window for **3D Plot Group**, locate the **Plot Settings** section.
- 3 From the **View** list, choose **New view**.
- 4 In the **Stress Comparison** toolbar, click  **Plot**.

Finally, disable the circuit board thermal expansion in the first study, so that you can compute the fixed configuration again.

FIXED BOARD

Step 1: Stationary

- 1 In the **Model Builder** window, under **Fixed Board** click **Step 1: Stationary**.
- 2 In the **Settings** window for **Stationary**, locate the **Physics and Variables Selection** section.
- 3 Select the **Modify model configuration for study step** checkbox.
- 4 In the tree, select **Component 1 (comp1) > Solid Mechanics (solid) > Fixed Constraint 1 > Thermal Expansion 1**.
- 5 Click  **Disable**.

Appendix — Geometry Modeling Instructions

From the **File** menu, choose **New**.

NEW

In the **New** window, click  **Blank Model**.

ADD COMPONENT

In the **Home** toolbar, click  **Add Component** and choose **3D**.

GEOMETRY 1

- 1 In the **Settings** window for **Geometry**, locate the **Units** section.
- 2 From the **Length unit** list, choose **µm**.

Work Plane 1 (wp1)

- 1 In the **Geometry** toolbar, click  **Work Plane**.

2 In the **Settings** window for **Work Plane**, click  **Go to Plane Geometry**.

Work Plane 1 (wp1) > Plane Geometry

In the **Model Builder** window, click **Plane Geometry**.

Work Plane 1 (wp1) > Rectangle 1 (r1)

1 In the **Work Plane** toolbar, click  **Rectangle**.

2 In the **Settings** window for **Rectangle**, locate the **Size and Shape** section.

3 In the **Width** text field, type 10.

4 In the **Height** text field, type 80.

5 Locate the **Position** section. In the **xw** text field, type -100.

6 Click to expand the **Layers** section. In the table, enter the following settings:

Layer name	Thickness (µm)
Layer 1	10

7 In the **Work Plane** toolbar, click  **Build All**.

Work Plane 1 (wp1) > Circular Arc 1 (ca1)

1 In the **Work Plane** toolbar, click  **More Primitives** and choose **Circular Arc**.

2 In the **Settings** window for **Circular Arc**, locate the **Center** section.

3 In the **xw** text field, type -80.

4 In the **yw** text field, type 80.

5 Locate the **Radius** section. In the **Radius** text field, type 20.

6 Locate the **Angles** section. In the **End angle** text field, type 180.

Work Plane 1 (wp1) > Thicken 1 (th1)

1 In the **Work Plane** toolbar, click  **Conversions** and choose **Thicken**.

2 Select the object **ca1** only.

3 In the **Settings** window for **Thicken**, locate the **Options** section.

4 From the **Offset** list, choose **Asymmetric**.



5 In the **Upside thickness** text field, type 10.

Work Plane 1 (wp1) > Copy 1 (copy1)

1 In the **Work Plane** toolbar, click  **Transforms** and choose **Copy**.



2 Select the object **r1** only.

3 In the **Settings** window for **Copy**, locate the **Displacement** section.

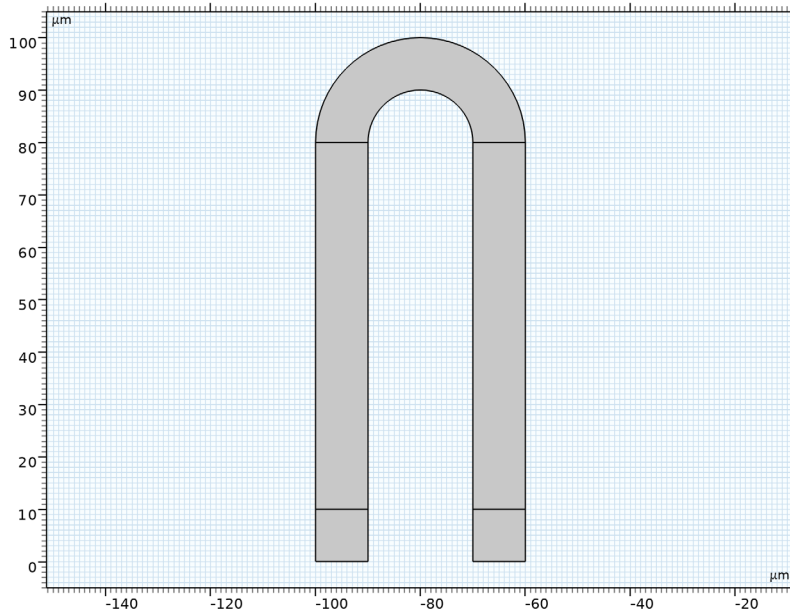
- 4 In the **xw** text field, type 30.
- 5 In the **Work Plane** toolbar, click  **Build All**.
- 6 Click the  **Zoom Extents** button in the **Graphics** toolbar.





Work Plane 1 (wp1) > Array 1 (arr1)

- 1 In the **Work Plane** toolbar, click  **Transforms** and choose **Array**.
- 2 Click in the **Graphics** window and then press Ctrl+A to select all objects.
- 3 In the **Settings** window for **Array**, locate the **Size** section.
- 4 From the **Array type** list, choose **Linear**.
- 5 In the **Size** text field, type 4.
- 6 Locate the **Displacement** section. In the **xw** text field, type 50.
- 7 In the **Work Plane** toolbar, click  **Build All**.

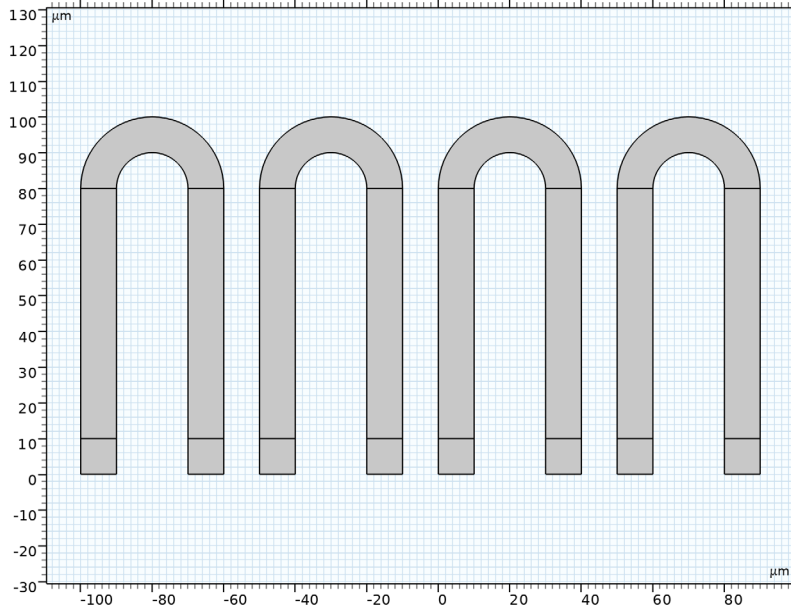
8 Click the  **Zoom Extends** button in the **Graphics** toolbar.



Work Plane 1 (wp1) > Rectangle 2 (r2)

- 1 In the **Work Plane** toolbar, click  **Rectangle**.
- 2 In the **Settings** window for **Rectangle**, locate the **Size and Shape** section.
- 3 In the **Width** text field, type 10.
- 4 In the **Height** text field, type 10.
- 5 Locate the **Position** section. In the **xw** text field, type -60.
- 6 In the **Work Plane** toolbar, click  **Build All**.

7 Click the  **Zoom Extents** button in the **Graphics** toolbar.

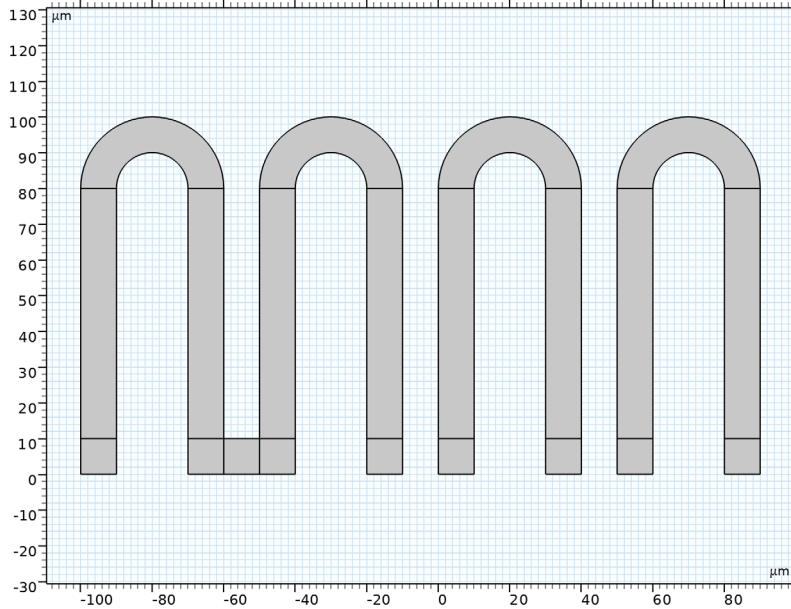

Work Plane 1 (wp1) > Array 2 (arr2)

1 In the **Work Plane** toolbar, click  **Transforms** and choose **Array**.

2 Select the object **r2** only.

3 In the **Settings** window for **Array**, locate the **Size** section.

4 From the **Array type** list, choose **Linear**.

5 In the **Size** text field, type 3.

6 Locate the **Displacement** section. In the **xw** text field, type 50.

7 In the **Work Plane** toolbar, click  **Build All**.

Work Plane 1 (wp1) > Ignore Edges 1 (ige1)

1 In the **Work Plane** toolbar, click  **Virtual Operations** and choose **Ignore Edges**.

2 On the object **fin**, select Boundaries 4 and 59 only.

3 In the **Work Plane** toolbar, click  **Build All**.

4 Click the  **Zoom Extents** button in the **Graphics** toolbar.

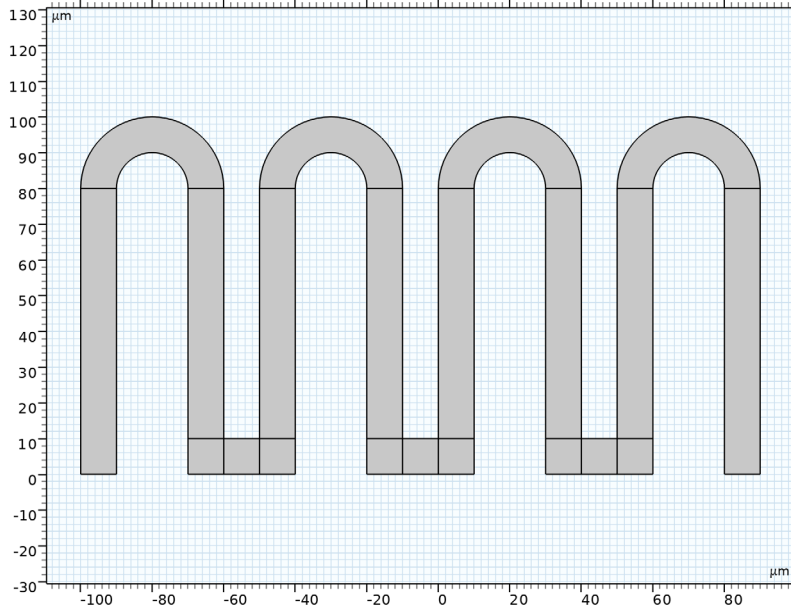

Extrude 1 (ext1)

- 1 In the **Model Builder** window, right-click **Geometry 1** and choose **Extrude**.
- 2 In the **Settings** window for **Extrude**, locate the **Distances** section.
- 3 In the table, enter the following settings:

Distances (μm)
10

4 Click  **Build All Objects**.

5 Click the  **Zoom Extents** button in the **Graphics** toolbar.

