



Model created in COMSOL Multiphysics 6.4

Piezoelectric Shear-Actuated Beam

Introduction

This example performs a static analysis on a piezoelectric actuator based on the movement of a cantilever beam, using the Piezoelectricity predefined multiphysics interface. Inspired by work done by V. Piefort (Ref. 1) and A. Benjeddou (Ref. 2), it models a sandwich beam using the shear mode of the piezoelectric material to deflect the tip.

Model Definition

GEOMETRY

The model consists of a 100-mm long sandwiched cantilever beam (Figure 1).

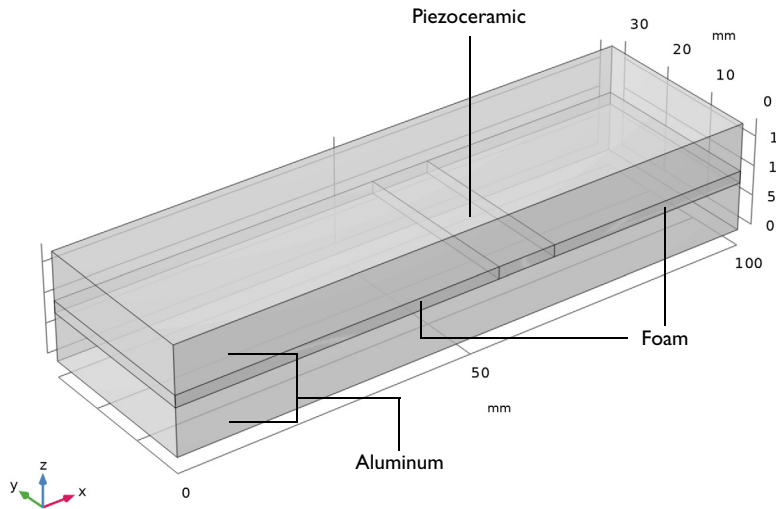

Figure 1: The shear bender geometry. Note that a piezoceramic material replaces part of the foam core.

This beam is composed of a 2-mm thick flexible foam core sandwiched by two 8-mm thick aluminum layers. Furthermore, the device replaces part of the foam core with a 10-mm long piezoceramic actuator that is positioned between $x = 55$ mm and $x = 65$ mm. The cantilever beam is oriented along the global x -axis.

BOUNDARY CONDITIONS

- *Solid Mechanics*: the cantilever beam is fixed at its surfaces at $x = 0$; all other surfaces are free.
- *Electrostatics*: The system applies a 20 V potential difference between the top and bottom surfaces of the piezoceramic domain (Figure 2). This gives rise to an electric field perpendicular to the poling direction (x direction) and thus induces a transverse shear strain.

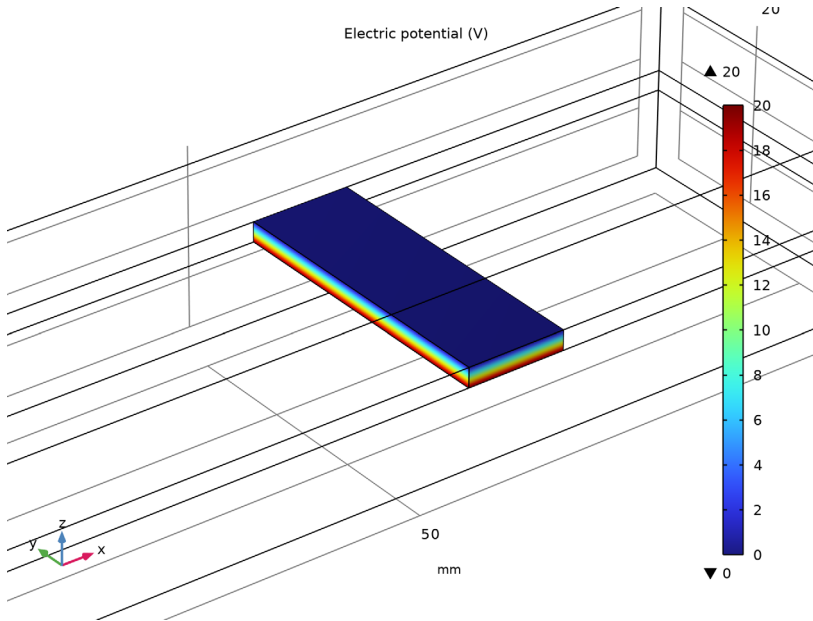

Figure 2: Applied voltage through the piezoelectric material.

MATERIAL PROPERTIES

The following table lists the material properties for the aluminum layers and the foam core:

Property	Aluminum	Foam	Piezoceramic
E	70 GPa	35.3 MPa	-
ν	0.35	0.383	-
ρ	2700 kg/m ³	32 kg/m ³	7500 kg/m ³

Aluminum is available as a predefined material, whereas you must define the foam material manually.

The piezoceramic material in the actuator, PZT-5H, is already defined in the material library. Thus, you do not need to enter the components of the elasticity matrix, c_E , the piezoelectric coupling matrix, e , or the relative permittivity matrix, ϵ_{rS} .

Results

The shear deformation of the piezoceramic core layer and the flexible foam layer induce a bending action. [Figure 3](#) shows the resulting tip deflection. The model calculates this deflection as 83 nm, a result that agrees well with those of [Ref. 1](#) and [Ref. 2](#).

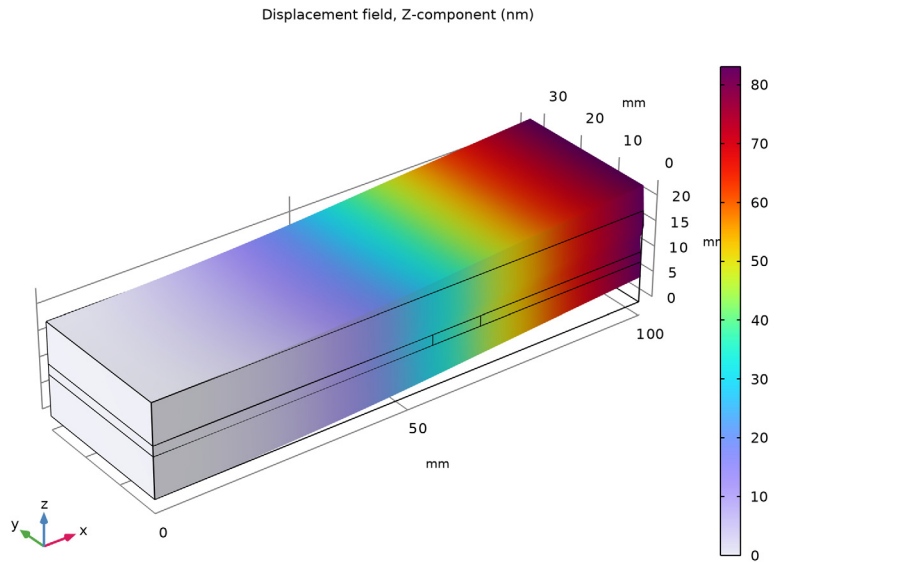

Figure 3: Tip deflection with the piezoceramic positioned at $x = 60$ mm.

Notes About the COMSOL Implementation

The matrix components for the piezoelectric material properties refer to a coordinate system, where the poling direction is the z direction. Because the poling direction of the piezoceramic actuator in this model is aligned with the x -axis, you need to use a local coordinate system in the material settings to rotate the piezoceramic material.

More specifically, you define a local coordinate system that is rotated 90 degrees about the global y -axis. Then, you use this coordinate system in the piezoelectric material settings to rotate the material so that the polarization direction is aligned with the x -axis (Figure 4).

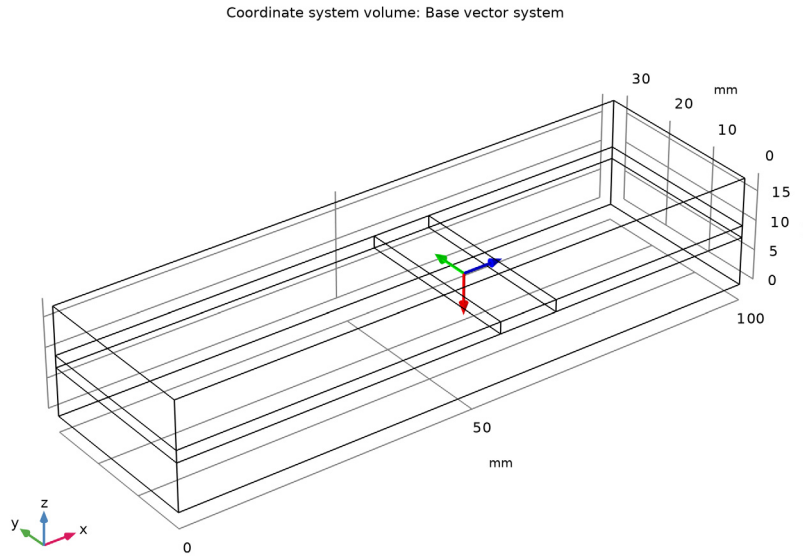

Figure 4: Definition of local coordinate system to define the piezoelectric orientation. The material is poled along the local x_3 direction (blue arrow).

References

1. V. Piefort, *Finite Element Modelling of Piezoelectric Active Structures*, PhD thesis, Université Libre de Bruxelles, Belgium, Dept. Mechanical Engineering and Robotics, 2001.
2. A. Benjeddou, M.A. Trindade, and R. Ohayon, *A Unified Beam Finite Element Model for Extension and Shear Piezoelectric Actuation Mechanisms*, CNAM (Paris, France), Structural Mechanics and Coupled Systems Laboratory, 1997.

Application Library path: MEMS_Module/Piezoelectric_Devices/shear_bender



Modeling Instructions

From the **File** menu, choose **New**.

NEW

In the **New** window, click  **Model Wizard**.



MODEL WIZARD

- 1 In the **Model Wizard** window, click  **3D**.
- 2 In the **Select Physics** tree, select **Structural Mechanics > Electromagnetics-Structure Interaction > Piezoelectricity > Piezoelectricity, Solid**.
- 3 Click **Add**.
- 4 Click  **Study**.
- 5 In the **Select Study** tree, select **General Studies > Stationary**.
- 6 Click  **Done**.

GEOMETRY I

- 1 In the **Model Builder** window, under **Component 1 (comp1)** click **Geometry 1**.
- 2 In the **Settings** window for **Geometry**, locate the **Units** section.
- 3 From the **Length unit** list, choose **mm**.

Block 1 (blk1)





- 1 In the **Geometry** toolbar, click  **Block**.
- 2 In the **Settings** window for **Block**, locate the **Size and Shape** section.
- 3 In the **Width** text field, type 100.
- 4 In the **Depth** text field, type 30.
- 5 In the **Height** text field, type 18.
- 6 Click  **Build Selected**.

Block 2 (blk2)

- 1 In the **Geometry** toolbar, click  **Block**.
- 2 In the **Settings** window for **Block**, locate the **Size and Shape** section.
- 3 In the **Width** text field, type 100.
- 4 In the **Depth** text field, type 30.
- 5 In the **Height** text field, type 2.
- 6 Locate the **Position** section. In the **z** text field, type 8.

- 7 Click to expand the **Layers** section. Find the **Layer position** subsection. Select the **Left** checkbox.
- 8 Clear the **Bottom** checkbox.
- 9 In the table, enter the following settings:

Layer name	Thickness (mm)
Layer 1	55
Layer 2	10

- 10 Click  **Build All Objects**.
- 11 Click the  **Zoom Extents** button in the **Graphics** toolbar.
The model geometry is now complete.
- 12 Click the  **Transparency** button in the **Graphics** toolbar.
The geometry in the **Graphics** window should now look like that in [Figure 1](#).
- 13 Click the  **Transparency** button in the **Graphics** toolbar.

DEFINITIONS

Define a coordinate system whose third axis is aligned with the global x -axis, that is, the polarization direction of the piezoceramic material. Choose the second axis to be parallel to the global y -axis.

Base Vector System 2 (sys2)

- 1 In the **Definitions** toolbar, click  **Coordinate Systems** and choose **Base Vector System**.
- 2 In the **Settings** window for **Base Vector System**, locate the **Base Vectors** section.
- 3 In the table, enter the following settings:

	x	y	z
x1	0	0	-1
x3	1	0	0

Leave the other components at their default values. You will use this coordinate system in the piezoelectric material settings.

- 4 Find the **Simplifications** subsection. Select the **Assume orthonormal** checkbox.

ELECTROSTATICS (ES)

- 1 In the **Model Builder** window, under **Component 1 (comp1)** click **Electrostatics (es)**.
- 2 In the **Settings** window for **Electrostatics**, locate the **Domain Selection** section.

3 Click  **Clear Selection**.

4 Select Domain 4 only.

SOLID MECHANICS (SOLID)

Piezoelectric Material 1

1 In the **Model Builder** window, under **Component 1 (comp1) > Solid Mechanics (solid)** click **Piezoelectric Material 1**.

2 In the **Settings** window for **Piezoelectric Material**, locate the **Domain Selection** section.

3 Click  **Clear Selection**.

4 Select Domain 4 only.

5 Locate the **Coordinate System Selection** section. From the **Coordinate system** list, choose **Base Vector System 2 (sys2)**.

MATERIALS

For the aluminum layers, use a library material.

ADD MATERIAL

1 In the **Materials** toolbar, click  **Add Material** to open the **Add Material** window.

2 Go to the **Add Material** window.

3 In the tree, select **MEMS > Metals > Al - Aluminum**.

4 Click the **Add to Component** button in the window toolbar.

MATERIALS

Al - Aluminum (mat1)

1 In the **Settings** window for **Material**, locate the **Geometric Entity Selection** section.

2 Click  **Clear Selection**.

3 Select Domains 1 and 3 only.

For the foam core, specify the material properties by hand.

Foam

1 In the **Model Builder** window, right-click **Materials** and choose **Blank Material**.

2 In the **Settings** window for **Material**, type Foam in the **Label** text field.

3 Select Domains 2 and 5 only.

4 Locate the **Material Contents** section. In the table, enter the following settings:

Property	Variable	Value	Unit	Property group
Young's modulus	E	35.3 [MPa]	Pa	Young's modulus and Poisson's ratio
Poisson's ratio	nu	0.383	l	Young's modulus and Poisson's ratio
Density	rho	32	kg/m ³	Basic

The piezoceramic PZT-5H is available as a predefined material.

ADD MATERIAL

- 1 Go to the **Add Material** window.
- 2 In the tree, select **Piezoelectric > Lead Zirconate Titanate (PZT-5H)**.
- 3 Click the **Add to Component** button in the window toolbar.

Add Material

- 1 From the **Home** menu, choose **Add Material**.
- 2 Select Domain 4 only.

SOLID MECHANICS (SOLID)

Fixed Constraint 1

- 1 In the **Model Builder** window, expand the **Component 1 (comp1) > Materials > Foam (mat2)** node.
- 2 Right-click **Component 1 (comp1) > Solid Mechanics (solid)** and choose **Fixed Constraint**.
- 3 Select Boundaries 1, 4, and 7 only.

ELECTROSTATICS (ES)

In the **Model Builder** window, under **Component 1 (comp1)** click **Electrostatics (es)**.

Electric Potential 1

- 1 In the **Physics** toolbar, click  **Boundaries** and choose **Electric Potential**.
- 2 Select Boundary 16 only.
- 3 In the **Settings** window for **Electric Potential**, locate the **Electric Potential** section.
- 4 In the V_0 text field, type 20.

Ground 1

- 1 In the **Physics** toolbar, click  **Boundaries** and choose **Ground**.



- 2 Select Boundary 17 only.

MESH I

Swept I

- 1 In the **Mesh** toolbar, click  **Swept**.
- 2 In the **Settings** window for **Swept**, click to expand the **Source Faces** section.
- 3 Select Boundaries 9, 17, and 22 only.

Distribution I

- 1 Right-click **Swept I** and choose **Distribution**.
- 2 In the **Settings** window for **Distribution**, locate the **Distribution** section.
- 3 In the **Number of elements** text field, type 2.
- 4 Click  **Build All**.
- 5 Click the  **Zoom Extents** button in the **Graphics** toolbar.
The mesh consists of 198 hexahedral elements.
- 6 In the **Model Builder** window, click **Mesh I**.

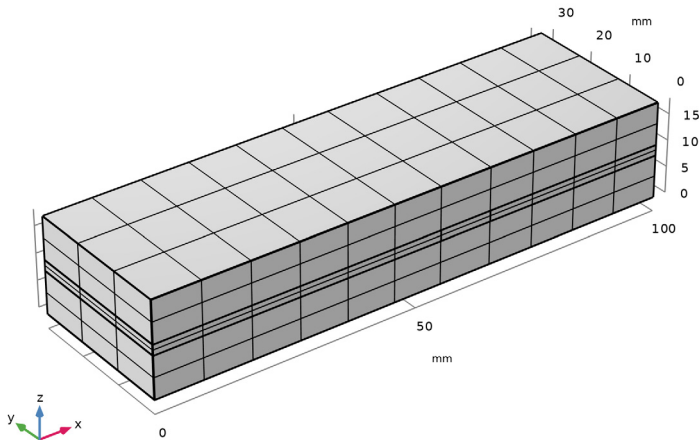

STUDY I

- In the **Study** toolbar, click  **Compute**.



RESULTS

Displacement (solid)

Replace the default stress plot by displacement to reproduce the plot shown in [Figure 3](#).

- 1 In the **Settings** window for **3D Plot Group**, type **Displacement (solid)** in the **Label** text field.

Volume 1

- 1 In the **Model Builder** window, expand the **Displacement (solid)** node, then click **Volume 1**.
- 2 In the **Settings** window for **Volume**, click **Replace Expression** in the upper-right corner of the **Expression** section. From the menu, choose **Component 1 (comp1) > Solid Mechanics > Displacement > Displacement field - m > w - Displacement field, Z-component**.
- 3 Locate the **Expression** section. From the **Unit** list, choose **nm**.
- 4 In the **Displacement (solid)** toolbar, click  **Plot**.
- 5 Click the  **Go to Default View** button in the **Graphics** toolbar.



Electric Potential (es)

In the **Model Builder** window, expand the **Electric Potential (es)** node.

Multislice 1, Streamline Multislice 1

- 1 In the **Model Builder** window, under **Results > Electric Potential (es)**, Ctrl-click to select **Multislice 1** and **Streamline Multislice 1**.
- 2 Right-click and choose **Delete**.

Surface 1

- 1 Right-click **Electric Potential (es)** and choose **Surface**.
- 2 In the **Settings** window for **Surface**, click **Replace Expression** in the upper-right corner of the **Expression** section. From the menu, choose **Component 1 (comp1) > Electrostatics > Electric > V - Electric potential - V**.
- 3 In the **Electric Potential (es)** toolbar, click  **Plot**.
Zoom in to find a plot similar to [Figure 2](#).
- 4 Click the  **Zoom In** button in the **Graphics** toolbar.
- 5 Click the  **Zoom Extents** button in the **Graphics** toolbar.



Show the base vector that defines the polarization of the piezoelectric material, shown on [Figure 4](#).

PZT coordinate system

- 1 In the **Results** toolbar, click  **3D Plot Group**.

- 2 In the **Settings** window for **3D Plot Group**, type PZT coordinate system in the **Label** text field.

Coordinate System Volume 1

- 1 In the **PZT coordinate system** toolbar, click  **More Plots** and choose **Coordinate System Volume**.
- 2 In the **Settings** window for **Coordinate System Volume**, locate the **Coordinate System** section.
- 3 From the **Coordinate system** list, choose **Base Vector System 2 (sys2)**.
- 4 Locate the **Positioning** section. Find the **x grid points** subsection. From the **Entry method** list, choose **Coordinates**.
- 5 In the **Coordinates** text field, type 60.
- 6 Find the **y grid points** subsection. In the **Points** text field, type 1.
- 7 Find the **z grid points** subsection. In the **Points** text field, type 1.
- 8 In the **PZT coordinate system** toolbar, click  **Plot**.