



Model created in COMSOL Multiphysics 6.4

Residual Stress in a Thin-Film Resonator — 3D

Introduction

Almost all surface-micromachined thin films experience residual stress as a result of the fabrication process. The most common source of residual stress is thermal stress, which is caused by a change in temperature experienced during the fabrication sequence and also due to the difference in the coefficient of thermal expansion between the film and the substrate. This tutorial shows how to model thermal residual stress due to a temperature difference and how it changes the resonant frequency of a thin-film resonator. The substrate is not included in the model and it is also assumed that at a given state (which indicates a particular step of the process sequence), the temperature is uniform throughout the cantilever.

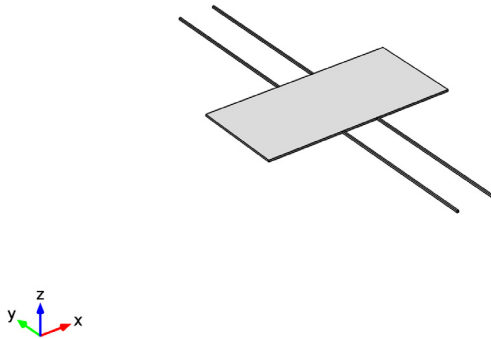

Figure 1: A thin-film resonator with four straight cantilever beam springs.

The tutorial investigates two design choices; a resonator with straight cantilevers (Figure 1) and another one with folded cantilevers (Figure 2). For each of the designs, the resonant frequency is computed for the cases when the structure is unstressed and when it is subjected to a residual thermal stress. The results obtained from these 3D models can

be compared with analytical solutions by referring to the Application Libraries tutorial [Residual Stress in a Thin-Film Resonator — 2D](#).

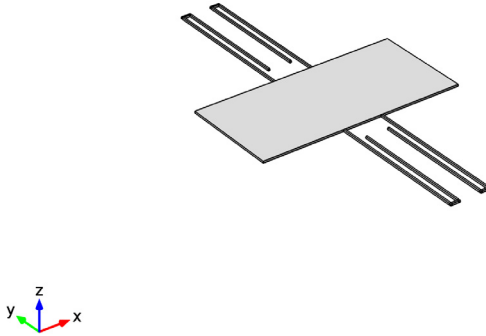

Figure 2: A thin-film resonator with four folded cantilever beam springs.

Model Definition

This tutorial uses the dimensions and material properties presented in [Table 1](#) and [Table 2](#). These values were obtained from the example in Chapter 27.2.5 in [Ref. 1](#). This simulation models thermal residual stress using the Thermal Expansion feature in the Solid Mechanics interface. The coefficient of thermal expansion is computed by assuming a residual stress of 50 MPa in the straight cantilevers, a film deposition temperature of 605°C (see Chapter 16.13.2.3 in [Ref. 1](#)) and a room temperature of 25°C.

TABLE 1: DIMENSIONS OF THE STRUCTURE.

PARAMETER	STRAIGHT CANTILEVERS	FOLDED CANTILEVERS			PLATE
		L1	L2	L3	
Length	200 μm	170 μm	10 μm	146 μm	250 μm
Width	2 μm	2 μm	2 μm	2 μm	120 μm
Thickness	2.25 μm	2.25 μm	2.25 μm	2.25 μm	2.25 μm

TABLE 2: MATERIAL PROPERTIES OF THE STRUCTURE.

PROPERTY	VALUE
Material	polysilicon
Young's modulus	155 GPa
Poisson's ratio	0.23
Density	2330 kg/m ³
T ₀	605°C
T ₁	25°C

In order to determine the eigenfrequencies for the case with residual stress, a Prestressed-Eigenfrequency Study is used. This predefined study type first solves for a static thermal expansion problem to compute the residual stress. The solution of this static problem is then used to create a shift in the linearization point around which the eigenfrequencies are then computed. This approach accurately computes the shift in eigenfrequency by accounting for the stress-stiffening effect.

Results and Discussion

Table 3 summarizes the resonant frequencies for the first in-plane bending eigenmode. The solutions from the 3D models are compared with those obtained from a 2D plane-stress model available in the Application Libraries tutorial [Residual Stress in a Thin-Film Resonator — 2D](#). As the table shows, the resonant frequency for the straight cantilevers increases significantly when the model includes residual stress. As expected, the stress sensitivity of the resonant frequency is reduced by folding the cantilevers. The results from the 3D models agree closely with those obtained from the 2D models. This indicates that such thin-film resonators can be efficiently modeled using a 2D plane-stress approach.

TABLE 3: RESONANT FREQUENCIES WITH AND WITHOUT RESIDUAL STRESS.

	STRAIGHT CANTILEVERS		FOLDED CANTILEVERS	
	2D MODEL	3D MODEL	2D MODEL	3D MODEL
Without stress	14.82 kHz	14.91 kHz	14.11 kHz	14.18 kHz
With residual stress	32.05 kHz	32.25 kHz	14.22 kHz	14.29 kHz

Note that for the 2D models, the first (lowest) eigenmode is the in-plane bending mode. However for the 3D models, the first (lowest) eigenmode is an out-of-plane torsional mode that you see in the default plot when you solve the Eigenfrequency study. The desired in-plane bending mode is the second eigenmode in the list of computed solutions. Hence, the main advantage of the 3D model is in finding any eigenmode where the resonator deforms largely in the out-of-plane direction.

Figure 3 and Figure 4 show the first in-plane bending resonance mode for the unstressed resonator with straight and folded cantilevers respectively.

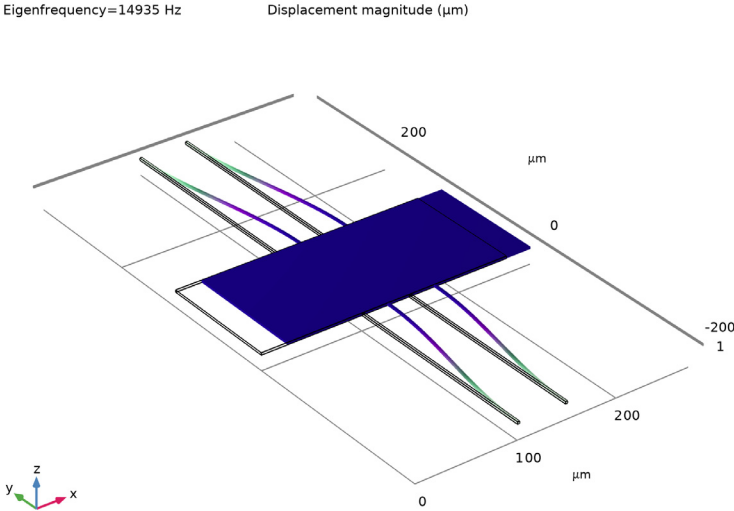

Figure 3: The first in-plane bending eigenmode of the unstressed resonator with straight cantilevers.

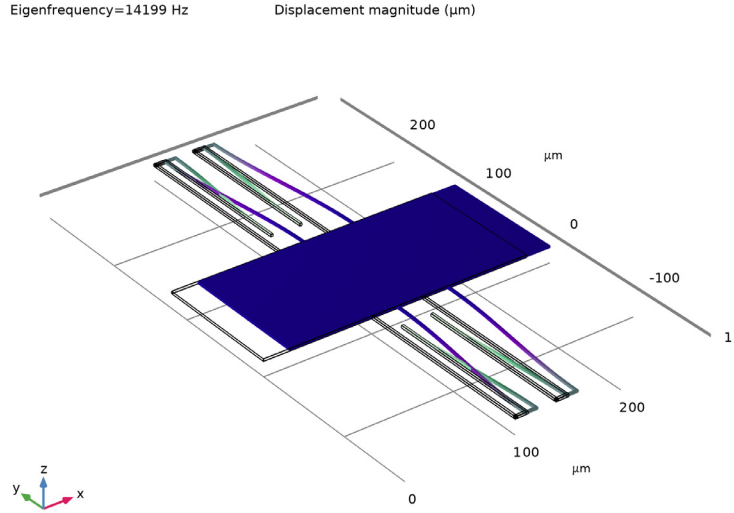

Figure 4: The first in-plane bending eigenmode of the unstressed resonator with folded cantilevers.

Figure 5 and Figure 7 show the first in-plane bending resonance mode for the resonator with straight and folded cantilevers respectively when they have a residual thermal stress.

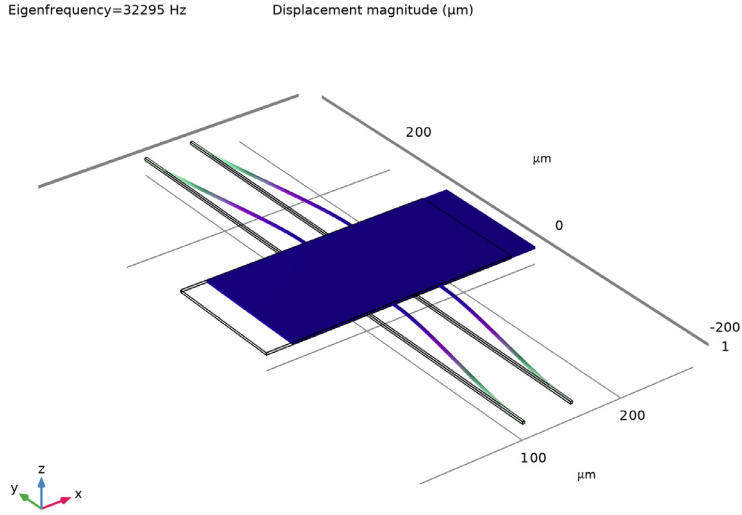

Figure 5: The first in-plane bending eigenmode of the resonator with straight cantilevers having residual thermal stress.

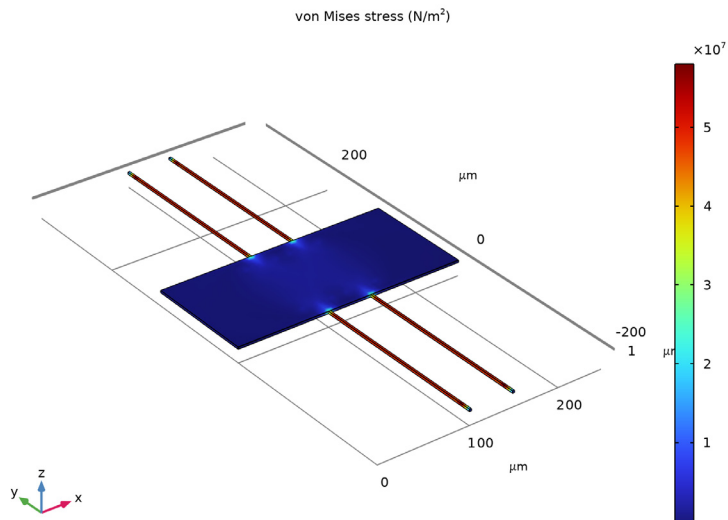

Figure 6: Residual thermal stress in the resonator with straight cantilevers when it is cooled from 605°C to 25°C .

Figure 6 and Figure 8 show the residual thermal stress (von Mises stress) distribution in the resonator with straight and folded cantilevers respectively when they are cooled from 605°C to 25°C. Figure 6 shows that the residual stress is almost uniform in the straight cantilever and is about 49 MPa. Figure 8 shows that the folded configuration significantly reduces the residual stress build-up. In this case the residual stress is around 2 MPa in most part of the cantilever except near the fixed end where it is close to 44 MPa.

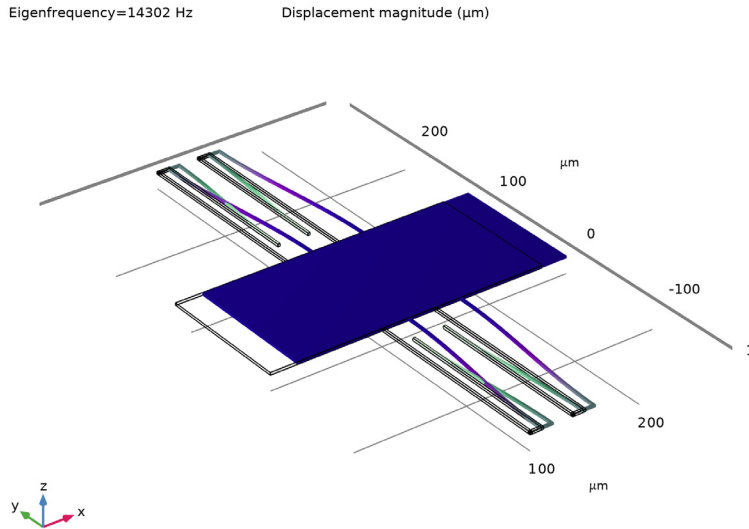

Figure 7: The first in-plane bending eigenmode of the resonator with folded cantilevers having residual thermal stress.

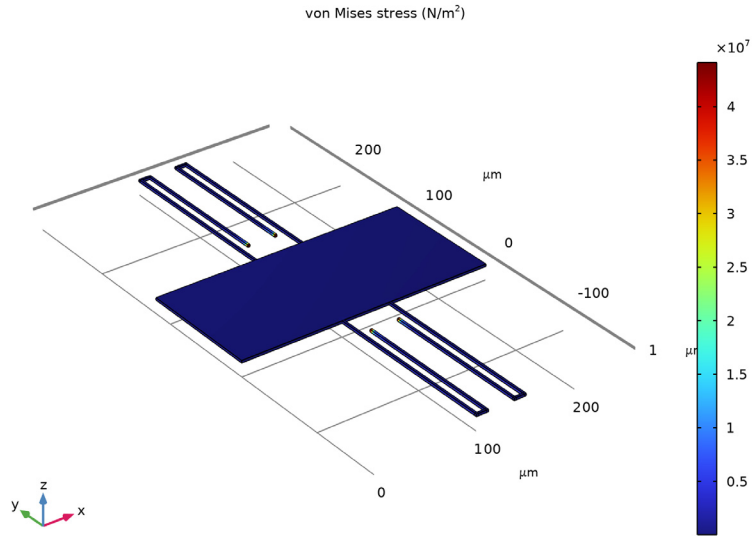

Figure 8: Residual thermal stress in the resonator with folded cantilevers when it is cooled from 605°C to 25°C.

Reference

1. M. Gad-el-Hak, ed., *The MEMS Handbook*, CRC Press, London, 2002, ch. 16.12 and 27.2.5.

Application Library path: MEMS_Module/Actuators/
residual_stress_resonator_3d



Modeling Instructions.

From the **File** menu, choose **New**.

NEW

In the **New** window, click  **Model Wizard**.

MODEL WIZARD

- 1 In the **Model Wizard** window, click  **3D**.
- 2 In the **Select Physics** tree, select **Structural Mechanics > Solid Mechanics (solid)**.
- 3 Click **Add**.
- 4 Click  **Study**.
- 5 In the **Select Study** tree, select **General Studies > Eigenfrequency**.
- 6 Click  **Done**.

GEOMETRY I

Load in the required global parameters. As well as defining some model variables, these values are used later for comparison between the model and the analytical solution.

GLOBAL DEFINITIONS

Parameters I

- 1 In the **Model Builder** window, under **Global Definitions** click **Parameters I**.
- 2 In the **Settings** window for **Parameters**, locate the **Parameters** section.
- 3 Click  **Load from File**.
- 4 Browse to the model's Application Libraries folder and double-click the file `residual_stress_resonator_3d_parameters.txt`.

First create a component to model the resonator with straight cantilevers. For convenience, the device geometry will be inserted from an existing file. You can read the instructions for creating the geometry in the [Appendix — Geometry Instructions](#).

GEOMETRY I

- 1 In the **Geometry** toolbar, click **Insert Sequence** and choose **Insert Sequence**.
- 2 Browse to the model's Application Libraries folder and double-click the file `residual_stress_resonator_3d_geom_sequence.mph`.
- 3 In the **Insert Sequence** dialog, click **OK**.
- 4 In the **Geometry** toolbar, click  **Build All**.



Next set up the required solid mechanics physics for the problem by adding a **Thermal Expansion** subfeature and specifying the fixed boundaries.

SOLID MECHANICS (SOLID)

Linear Elastic Material 1

In the **Model Builder** window, under **Component 1 (comp1) > Solid Mechanics (solid)** click **Linear Elastic Material 1**.

Thermal Expansion 1

- 1 In the **Physics** toolbar, click  **Attributes** and choose **Thermal Expansion**.
- 2 In the **Settings** window for **Thermal Expansion**, locate the **Model Input** section.
- 3 From the T list, choose **User defined**. In the associated text field, type T_0 .
- 4 Click  **Go to Source** for **Volume reference temperature**.

GLOBAL DEFINITIONS



Default Model Inputs

- 1 In the **Model Builder** window, under **Global Definitions** click **Default Model Inputs**.
- 2 In the **Settings** window for **Default Model Inputs**, locate the **Browse Model Inputs** section.
- 3 Find the **Expression for remaining selection** subsection. In the **Volume reference temperature** text field, type T_1 .

The reference strain for thermal expansion is now T_1 . This value will be common to all thermal expansion features in the model.

SOLID MECHANICS (SOLID)

Fixed Constraint 1

- 1 In the **Physics** toolbar, click  **Boundaries** and choose **Fixed Constraint**.
- 2 In the **Settings** window for **Fixed Constraint**, locate the **Boundary Selection** section.
- 3 Click  **Paste Selection**.
- 4 In the **Paste Selection** dialog, type 7, 15, 21, 29 in the **Selection** text field.
- 5 Click **OK**.

Now add a new material to the component in order to define the required physical properties of the device.

MATERIALS

Material 1 (mat1)

- 1 In the **Model Builder** window, under **Component 1 (comp1)** right-click **Materials** and choose **Blank Material**.



- 2 In the **Settings** window for **Material**, locate the **Material Contents** section.
- 3 In the table, enter the following settings:

Property	Variable	Value	Unit	Property group
Young's modulus	E	E1	Pa	Young's modulus and Poisson's ratio
Poisson's ratio	nu	nu1	I	Young's modulus and Poisson's ratio
Density	rho	rho1	kg/m ³	Basic
Coefficient of thermal expansion	alpha_iso ; alpha_ii = alpha_iso, alpha_ij = 0	daT	I/K	Basic

Configure a suitable mesh, a **Mapped** and swept mesh is appropriate for this device geometry.

MESH I

Mapped I

- 1 In the **Mesh** toolbar, click  **More Generators** and choose **Mapped**.
- 2 In the **Settings** window for **Mapped**, locate the **Boundary Selection** section.
- 3 Click  **Paste Selection**.
- 4 In the **Paste Selection** dialog, type 4,9,14,23,28 in the **Selection** text field.
- 5 Click **OK**.

Distribution I

- 1 Right-click **Mapped I** and choose **Distribution**.
- 2 In the **Settings** window for **Distribution**, locate the **Edge Selection** section.
- 3 Click  **Paste Selection**.
- 4 In the **Paste Selection** dialog, type 16,21,44,49 in the **Selection** text field.
- 5 Click **OK**.
- 6 In the **Settings** window for **Distribution**, locate the **Distribution** section.

7 In the **Number of elements** text field, type 2.

Size

1 In the **Model Builder** window, under **Component 1 (comp1) > Mesh 1** click **Size**.

2 In the **Settings** window for **Size**, locate the **Element Size** section.

3 From the **Predefined** list, choose **Extra fine**.

Swept 1

In the **Mesh** toolbar, click  **Swept**.

Distribution 1

1 Right-click **Swept 1** and choose **Distribution**.

2 In the **Settings** window for **Distribution**, locate the **Distribution** section.

3 In the **Number of elements** text field, type 2.

4 Click  **Build All**.

Add a second component to model the resonator with folded cantilevers. As with the first component, the device geometry will be inserted for convenience.

ADD COMPONENT

In the **Model Builder** window, right-click the root node and choose **Add Component > 3D**.

GEOMETRY 2

1 In the **Geometry** toolbar, click **Insert Sequence** and choose **Insert Sequence**.

2 Browse to the model's Application Libraries folder and double-click the file `residual_stress_resonator_3d_geom_sequence.mph`.

3 In the **Insert Sequence** dialog, select **Geometry 2** in the **Select geometry sequence to insert** list.

4 Click **OK**.

5 In the **Geometry** toolbar, click  **Build All**.

Now the solid mechanics physics can be configured, as with the first component. In addition, a material will be added to define the required properties of the second device and an appropriate mesh will be created.

ADD PHYSICS

1 In the **Home** toolbar, click  **Add Physics** to open the **Add Physics** window.

2 Go to the **Add Physics** window.

3 In the tree, select **Structural Mechanics > Solid Mechanics (solid)**.



- 4 Click the **Add to Component 2** button in the window toolbar.
- 5 In the **Home** toolbar, click  **Add Physics** to close the **Add Physics** window.

SOLID MECHANICS 2 (SOLID2)

Thermal Expansion 1

- 1 In the **Physics** toolbar, click  **Attributes** and choose **Thermal Expansion**.
- 2 In the **Settings** window for **Thermal Expansion**, locate the **Model Input** section.
- 3 From the T list, choose **User defined**. In the associated text field, type T0.

Fixed Constraint 1

- 1 In the **Physics** toolbar, click  **Boundaries** and choose **Fixed Constraint**.
- 2 In the **Settings** window for **Fixed Constraint**, locate the **Boundary Selection** section.
- 3 Click  **Paste Selection**.
- 4 In the **Paste Selection** dialog, type 46, 48, 68, 70 in the **Selection** text field.
- 5 Click **OK**.

MATERIALS

Material 2 (mat2)



- 1 In the **Model Builder** window, under **Component 2 (comp2)** right-click **Materials** and choose **Blank Material**.
- 2 In the **Settings** window for **Material**, locate the **Material Contents** section.
- 3 In the table, enter the following settings:

Property	Variable	Value	Unit	Property group
Young's modulus	E	E1	Pa	Young's modulus and Poisson's ratio
Poisson's ratio	nu	nu1	I	Young's modulus and Poisson's ratio

Property	Variable	Value	Unit	Property group
Density	rho	rho1	kg/m ³	Basic
Coefficient of thermal expansion	alpha_iso ; alpha_ii = alpha_iso, alpha_ij = 0	daT	1/K	Basic

MESH 2

Mapped 1

- 1 In the **Mesh** toolbar, click  **More Generators** and choose **Mapped**.
- 2 In the **Settings** window for **Mapped**, locate the **Boundary Selection** section.
- 3 Click  **Paste Selection**.
- 4 In the **Paste Selection** dialog, type 4, 9, 13, 18, 22, 27, 36, 41, 45, 50, 54, 63, 67, 72, 76, 81, 88, 93, 97, 102, 106 in the **Selection** text field.
- 5 Click **OK**.

Distribution 1

- 1 Right-click **Mapped 1** and choose **Distribution**.
- 2 In the **Settings** window for **Distribution**, locate the **Edge Selection** section.
- 3 Click  **Paste Selection**.
- 4 In the **Paste Selection** dialog, type 12, 21, 26, 30, 73, 78, 104, 113, 118, 122, 161, 166 in the **Selection** text field.
- 5 Click **OK**.
- 6 In the **Settings** window for **Distribution**, locate the **Distribution** section.
- 7 In the **Number of elements** text field, type 2.

Swept 1

In the **Mesh** toolbar, click  **Swept**.

Distribution 1

- 1 Right-click **Swept 1** and choose **Distribution**.
- 2 In the **Settings** window for **Distribution**, locate the **Distribution** section.
- 3 In the **Number of elements** text field, type 2.

Size

- 1 In the **Model Builder** window, under **Component 2 (comp2) > Mesh 2** click **Size**.

- 2 In the **Settings** window for **Size**, locate the **Element Size** section.
- 3 From the **Predefined** list, choose **Extra fine**.
- 4 Click  **Build All**.

In order to perform the required computations four studies are required. The first two studies, one for each of the components, are for the case of zero-stress. These studies require one **Eigenfrequency** solver step, which will be used to calculate the eigenfrequency and mode of each resonator.



STUDY 1 - STRAIGHT CANTILEVER, NO STRESS

- 1 In the **Model Builder** window, right-click **Study 1** and choose **Rename**.
- 2 In the **Rename Study** dialog, type Study 1 - Straight Cantilever, No Stress in the **New label** text field.
- 3 Click **OK**.

Step 1: Eigenfrequency

- 1 In the **Model Builder** window, under **Study 1 - Straight Cantilever, No Stress** click **Step 1: Eigenfrequency**.
- 2 In the **Settings** window for **Eigenfrequency**, locate the **Physics and Variables Selection** section.
- 3 In the **Solve for** column of the table, under **Component 2 (comp2)**, clear the checkbox for **Solid Mechanics 2 (solid2)**.

ADD STUDY

- 1 In the **Home** toolbar, click  **Add Study** to open the **Add Study** window.
- 2 Go to the **Add Study** window.
- 3 Find the **Studies** subsection. In the **Select Study** tree, select **General Studies > Eigenfrequency**.
- 4 Click the **Add Study** button in the window toolbar.
- 5 In the **Home** toolbar, click  **Add Study** to close the **Add Study** window.



STUDY 2 - FOLDED CANTILEVER, NO STRESS

- 1 In the **Model Builder** window, right-click **Study 2** and choose **Rename**.
- 2 In the **Rename Study** dialog, type Study 2 - Folded Cantilever, No Stress in the **New label** text field.
- 3 Click **OK**.

- 1 In the **Model Builder** window, under **Study 2 - Folded Cantilever, No Stress** click **Step 1: Eigenfrequency**.
- 2 In the **Settings** window for **Eigenfrequency**, locate the **Physics and Variables Selection** section.
- 3 In the **Solve for** column of the table, under **Component 1 (comp1)**, clear the checkbox for **Solid Mechanics (solid)**.

The second two studies require two study steps: an initial **Stationary** study step is used to calculate the residual thermal stress due to the difference between the fabrication and operation temperatures; the solution to this step is then used to shift the linearization point around which the eigenfrequencies are computed in a subsequent **Eigenfrequency** study step. **Prestressed Analysis, Eigenfrequency** studies are used as this study type contains the required study steps by default.

ADD STUDY

- 1 In the **Home** toolbar, click  **Add Study** to open the **Add Study** window.
- 2 Go to the **Add Study** window.
- 3 Find the **Studies** subsection. In the **Select Study** tree, select **Preset Studies for Selected Physics Interfaces > Eigenfrequency, Prestressed**.
- 4 Click the **Add Study** button in the window toolbar.
- 5 In the **Home** toolbar, click  **Add Study** to close the **Add Study** window.

STUDY 3 - STRAIGHT CANTILEVER, RESIDUAL STRESS

- 1 In the **Model Builder** window, right-click **Study 3** and choose **Rename**.
- 2 In the **Rename Study** dialog, type Study 3 - Straight Cantilever, Residual Stress in the **New label** text field.
- 3 Click **OK**.

Step 1: Stationary

- 1 In the **Model Builder** window, under **Study 3 - Straight Cantilever, Residual Stress** click **Step 1: Stationary**.
- 2 In the **Settings** window for **Stationary**, locate the **Physics and Variables Selection** section.
- 3 In the **Solve for** column of the table, under **Component 2 (comp2)**, clear the checkbox for **Solid Mechanics 2 (solid2)**.



In this case, it would be possible to use a geometrically linear study.

- 4 Locate the **Study Settings** section. Clear the **Include geometric nonlinearity** checkbox.

Step 2: Eigenfrequency

- 1 In the **Model Builder** window, click **Step 2: Eigenfrequency**.
- 2 In the **Settings** window for **Eigenfrequency**, locate the **Physics and Variables Selection** section.
- 3 In the **Solve for** column of the table, under **Component 2 (comp2)**, clear the checkbox for **Solid Mechanics 2 (solid2)**.

ADD STUDY

- 1 In the **Home** toolbar, click  **Add Study** to open the **Add Study** window.
- 2 Go to the **Add Study** window.
- 3 Find the **Studies** subsection. In the **Select Study** tree, select **Preset Studies for Selected Physics Interfaces > Eigenfrequency, Prestressed**.
- 4 Click the **Add Study** button in the window toolbar.
- 5 In the **Home** toolbar, click  **Add Study** to close the **Add Study** window.

STUDY 4 - FOLDED CANTILEVER, RESIDUAL STRESS

- 1 In the **Model Builder** window, right-click **Study 4** and choose **Rename**.
- 2 In the **Rename Study** dialog, type Study 4 - Folded Cantilever, Residual Stress in the **New label** text field.
- 3 Click **OK**.

Step 1: Stationary

- 1 In the **Model Builder** window, under **Study 4 - Folded Cantilever, Residual Stress** click **Step 1: Stationary**.
- 2 In the **Settings** window for **Stationary**, locate the **Physics and Variables Selection** section.
- 3 In the **Solve for** column of the table, under **Component 1 (comp1)**, clear the checkbox for **Solid Mechanics (solid)**.
- 4 Locate the **Study Settings** section. Clear the **Include geometric nonlinearity** checkbox.

Step 2: Eigenfrequency

- 1 In the **Model Builder** window, click **Step 2: Eigenfrequency**.
- 2 In the **Settings** window for **Eigenfrequency**, locate the **Physics and Variables Selection** section.
- 3 In the **Solve for** column of the table, under **Component 1 (comp1)**, clear the checkbox for **Solid Mechanics (solid)**.

The studies can now be solved and the results visualized.

STUDY 1 - STRAIGHT CANTILEVER, NO STRESS

In the **Study** toolbar, click  **Compute**.

RESULTS

Straight Cantilever, No Stress

- 1 In the **Settings** window for **3D Plot Group**, type Straight Cantilever, No Stress in the **Label** text field.
- 2 Locate the **Data** section. From the **Eigenfrequency (Hz)** list, choose **14935**.
- 3 In the **Straight Cantilever, No Stress** toolbar, click  **Plot**.

STUDY 2 - FOLDED CANTILEVER, NO STRESS

In the **Study** toolbar, click  **Compute**.

RESULTS

Folded Cantilever, No Stress

- 1 In the **Settings** window for **3D Plot Group**, type Folded Cantilever, No Stress in the **Label** text field.
- 2 Locate the **Data** section. From the **Eigenfrequency (Hz)** list, choose **14199**.
- 3 In the **Folded Cantilever, No Stress** toolbar, click  **Plot**.

STUDY 3 - STRAIGHT CANTILEVER, RESIDUAL STRESS

In the **Study** toolbar, click  **Compute**.

RESULTS

Straight Cantilever, Residual Stress

- 1 In the **Settings** window for **3D Plot Group**, type Straight Cantilever, Residual Stress in the **Label** text field.
- 2 Locate the **Data** section. From the **Eigenfrequency (Hz)** list, choose **32295**.
- 3 In the **Straight Cantilever, Residual Stress** toolbar, click  **Plot**.

STUDY 4 - FOLDED CANTILEVER, RESIDUAL STRESS

In the **Study** toolbar, click  **Compute**.

RESULTS

Folded Cantilever, Residual Stress

- 1 In the **Settings** window for **3D Plot Group**, type *Folded Cantilever, Residual Stress* in the **Label** text field.
- 2 Locate the **Data** section. From the **Eigenfrequency (Hz)** list, choose **I4302**.
- 3 In the **Folded Cantilever, Residual Stress** toolbar, click  **Plot**.

Residual Stress in Straight Cantilever

- 1 In the **Results** toolbar, click  **3D Plot Group**.
- 2 In the **Settings** window for **3D Plot Group**, type *Residual Stress in Straight Cantilever* in the **Label** text field.
- 3 Locate the **Data** section. From the **Dataset** list, choose **Study 3 - Straight Cantilever, Residual Stress/Solution Store 1 (7) (sol4)**.

Surface 1

- 1 Right-click **Residual Stress in Straight Cantilever** and choose **Surface**.
- 2 In the **Settings** window for **Surface**, locate the **Expression** section.
- 3 In the **Expression** text field, type `solid.mises`.
- 4 In the **Residual Stress in Straight Cantilever** toolbar, click  **Plot**.

Residual Stress in Folded Cantilever

- 1 In the **Results** toolbar, click  **3D Plot Group**.
- 2 In the **Settings** window for **3D Plot Group**, type *Residual Stress in Folded Cantilever* in the **Label** text field.
- 3 Locate the **Data** section. From the **Dataset** list, choose **Study 4 - Folded Cantilever, Residual Stress/Solution Store 2 (12) (sol6)**.

Surface 1

- 1 Right-click **Residual Stress in Folded Cantilever** and choose **Surface**.
- 2 In the **Settings** window for **Surface**, locate the **Expression** section.
- 3 In the **Expression** text field, type `solid2.mises`.
- 4 In the **Residual Stress in Folded Cantilever** toolbar, click  **Plot**.



Appendix — Geometry Instructions

From the **File** menu, choose **New**.

NEW

In the **New** window, click  **Model Wizard**.

MODEL WIZARD

- 1 In the **Model Wizard** window, click  **3D**.
- 2 In the **Select Physics** tree, select **Structural Mechanics > Solid Mechanics (solid)**.
- 3 Click **Add**.
- 4 Click  **Done**.

GEOMETRY I

- 1 In the **Model Builder** window, under **Component 1 (comp1)** click **Geometry 1**.
- 2 In the **Settings** window for **Geometry**, locate the **Units** section.
- 3 From the **Length unit** list, choose μm .

Work Plane 1 (wp1)

- 1 In the **Geometry** toolbar, click  **Work Plane**.
- 2 In the **Settings** window for **Work Plane**, click  **Go to Plane Geometry**.

Work Plane 1 (wp1) > Plane Geometry

In the **Model Builder** window, click **Plane Geometry**.

Work Plane 1 (wp1) > Rectangle 1 (r1)

- 1 In the **Work Plane** toolbar, click  **Rectangle**.
- 2 In the **Settings** window for **Rectangle**, locate the **Size and Shape** section.
- 3 In the **Width** text field, type 250.
- 4 In the **Height** text field, type 120.

Work Plane 1 (wp1) > Rectangle 2 (r2)

- 1 In the **Work Plane** toolbar, click  **Rectangle**.
- 2 In the **Settings** window for **Rectangle**, locate the **Size and Shape** section.
- 3 In the **Width** text field, type 2.
- 4 In the **Height** text field, type 200.
- 5 Locate the **Position** section. In the **xw** text field, type 100.
- 6 In the **yw** text field, type 120.

Work Plane 1 (wp1) > Array 1 (arr1)

- 1 In the **Work Plane** toolbar, click  **Transforms** and choose **Array**.

- 2 Select the object **r2** only.
- 3 In the **Settings** window for **Array**, locate the **Size** section.
- 4 In the **xw size** text field, type 2.
- 5 In the **yw size** text field, type 2.
- 6 Locate the **Displacement** section. In the **xw** text field, type 48.
- 7 In the **yw** text field, type -320.

Work Plane 1 (wp1) > Plane Geometry

In the **Work Plane** toolbar, click  **Build All**.

Extrude 1 (ext1)

- 1 In the **Model Builder** window, right-click **Geometry 1** and choose **Extrude**.
- 2 In the **Settings** window for **Extrude**, locate the **Distances** section.
- 3 In the table, enter the following settings:

Distances (μm)
2.25

- 4 Click  **Build All Objects**.

ADD COMPONENT

In the **Model Builder** window, right-click the root node and choose **Add Component > 3D**.

GEOMETRY 2

- 1 In the **Settings** window for **Geometry**, locate the **Units** section.
- 2 From the **Length unit** list, choose **μm**.

Work Plane 1 (wp1)

- 1 In the **Geometry** toolbar, click  **Work Plane**.
- 2 In the **Settings** window for **Work Plane**, click  **Go to Plane Geometry**.

Work Plane 1 (wp1) > Plane Geometry

In the **Model Builder** window, click **Plane Geometry**.

Work Plane 1 (wp1) > Rectangle 1 (r1)

- 1 In the **Work Plane** toolbar, click  **Rectangle**.
- 2 In the **Settings** window for **Rectangle**, locate the **Size and Shape** section.
- 3 In the **Width** text field, type 250.
- 4 In the **Height** text field, type 120.

Work Plane 1 (wp1) > Rectangle 2 (r2)

- 1 In the **Work Plane** toolbar, click  **Rectangle**.
- 2 In the **Settings** window for **Rectangle**, locate the **Size and Shape** section.
- 3 In the **Width** text field, type 2.
- 4 In the **Height** text field, type 172.
- 5 Locate the **Position** section. In the **xw** text field, type 100.
- 6 In the **yw** text field, type 120.



Work Plane 1 (wp1) > Rectangle 3 (r3)

- 1 In the **Work Plane** toolbar, click  **Rectangle**.
- 2 In the **Settings** window for **Rectangle**, locate the **Size and Shape** section.
- 3 In the **Width** text field, type 12.
- 4 In the **Height** text field, type 2.
- 5 Locate the **Position** section. In the **xw** text field, type 100.
- 6 In the **yw** text field, type 290.

Work Plane 1 (wp1) > Rectangle 4 (r4)

- 1 In the **Work Plane** toolbar, click  **Rectangle**.
- 2 In the **Settings** window for **Rectangle**, locate the **Size and Shape** section.
- 3 In the **Width** text field, type 2.
- 4 In the **Height** text field, type 148.
- 5 Locate the **Position** section. In the **xw** text field, type 110.
- 6 In the **yw** text field, type 144.

Work Plane 1 (wp1) > Mirror 1 (mir1)

- 1 In the **Work Plane** toolbar, click  **Transforms** and choose **Mirror**.
- 2 Click the  **Zoom Extents** button in the **Graphics** toolbar.
- 3 Select the objects **r2**, **r3**, and **r4** only.
- 4 In the **Model Builder** window, click **Mirror 1 (mir1)**.
- 5 In the **Settings** window for **Mirror**, locate the **Input** section.
- 6 Select the **Keep input objects** checkbox.
- 7 Locate the **Point on Line of Reflection** section. In the **xw** text field, type 125.

Work Plane 1 (wp1) > Mirror 2 (mir2)

- 1 In the **Work Plane** toolbar, click  **Transforms** and choose **Mirror**.

- 2 Select the objects **mir1(1)**, **mir1(2)**, **mir1(3)**, **r2**, **r3**, and **r4** only.
- 3 In the **Settings** window for **Mirror**, locate the **Input** section.
- 4 Select the **Keep input objects** checkbox.
- 5 Locate the **Point on Line of Reflection** section. In the **yw** text field, type 60.
- 6 Locate the **Normal Vector to Line of Reflection** section. In the **xw** text field, type 0.
- 7 In the **yw** text field, type 1.

Extrude 1 (ext1)

- 1 In the **Model Builder** window, right-click **Geometry 2** and choose **Extrude**.
- 2 In the **Settings** window for **Extrude**, locate the **Distances** section.
- 3 In the table, enter the following settings:

Distances (μm)
2.25

- 4 Click  **Build All Objects**.