



Model created in COMSOL Multiphysics 6.4

Dynamics of a Cylindrical Roller Bearing

Introduction

Bearings are used in machines to reduce the friction between moving parts and thereby smoothen their relative motion. Rolling element bearing is one of the widely used bearings, where rolling elements or rollers are used to support the load. These rollers can be of different shapes- for instance- spherical, cylindrical, or tapered cylindrical.

This model simulates the dynamics of a cylindrical roller bearing. Here, multiple cylindrical rollers are inserted between the outer and inner race, and held in place with the help of the cage. The inner race is connected to a rotating shaft and the outer race to a fixed foundation. All components of the bearing are assumed rigid. Frictional contact is modeled between rollers and races using rigid body contact with friction. The connection between rollers and the cage is simplified using hinge joints. An external load is applied on the inner race and a transient study is performed to analyze the lateral dynamics of inner race, dynamics of rollers and cage, contact and friction forces, and energy dissipation due to friction.

Model Definition

The model geometry consists of twelve identical cylindrical rollers of radius 6 mm, inserted between two concentric cylindrical races of thickness 4.875 mm each.

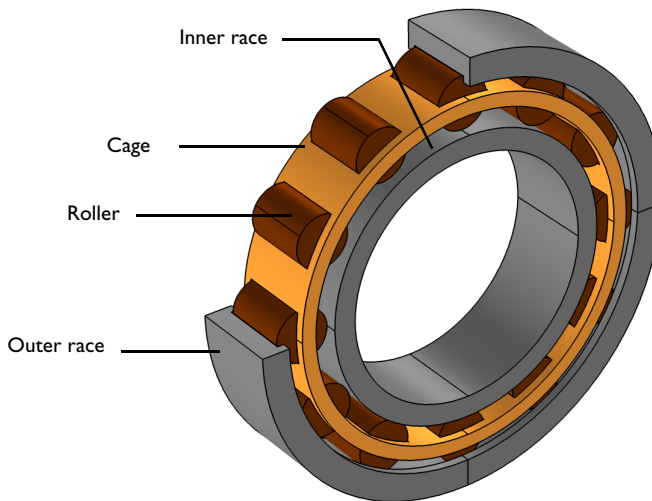

Figure 1: Model geometry of the cylindrical roller bearing.

The inner radius of outer race is 45.125 mm and the outer radius of inner race is 32.875 mm. As shown in [Figure 1](#), a slotted cylindrical ring called cage is used to hold the rollers in place and keep them separated. All components of the bearing are assumed rigid and use the material data for structural steel.

The connection between rollers and cage is modeled through hinge joints, having only one rotational degree of freedom about their axes (y -axis). The outer race is assumed to be connected to a fixed foundation without any translational or rotational motion. The inner race is connected to a shaft rotating with an angular speed of 5000 rpm. Additionally, a bearing load of 100 N is acting on inner race along $-z$ direction.

For each rigid roller, a line of contact exists with both inner and outer races. Using the rigid body contact with friction functionality, the interaction between each roller and races are modeled as frictional contacts. The coefficient of friction between the rollers and races is assumed as 0.1.

A time dependent study is performed for 0.06 s, which corresponds to five cycles of rotation of shaft or inner race, to analyze the dynamics of inner race, cage and rollers. The contact and frictional forces between races and rollers are also studied.

Results and Discussion

[Figure 2](#) shows the displacement in the inner race, rollers, and cage. As rollers are in contact with inner race, the rotation of inner race also leads to the rotation of rollers and cage. [Figure 3](#) shows the velocity of rollers and cage. The contact force between rollers and inner race is also plotted here.

As rollers are free to rotate about their own axes, they exhibit an additional spinning motion about their axes. This can be visualized by plotting the relative velocity of rollers with respect to cage as shown in [Figure 4](#).

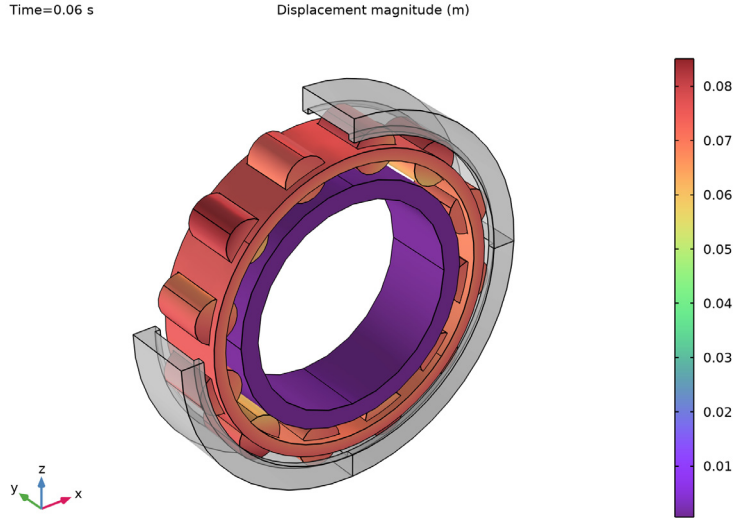

Figure 2: Displacement of different components in cylindrical roller bearing at $t = 0.06$ s.

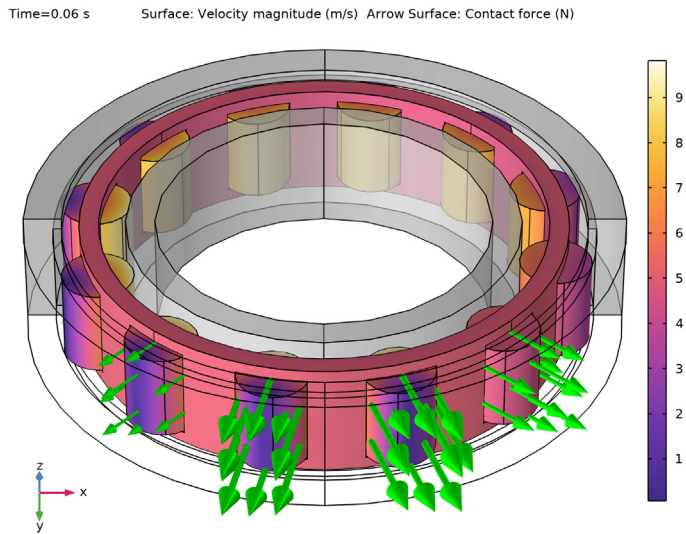

Figure 3: Velocity of rollers and cage at $t = 0.06$ s. Arrow plot shows the contact force between the rollers and inner race.

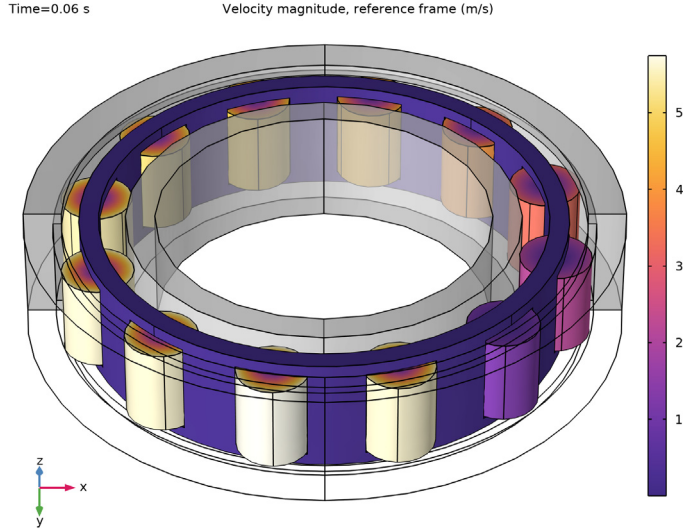

Figure 4: Relative velocity of rollers with respect to cage at $t = 0.06$ s.

The dynamics of the system is controlled by the inner race moving with a constant angular speed of 5000 rpm. This motion is transmitted to the contacting rollers and cage. [Figure 5](#) shows the angular speed of inner race and cage.

Due to the contact with the rotating inner race, the direction of spin of rollers would be opposite to that of inner race. Angular speed of three sample rollers is shown in [Figure 6](#). Contact and friction forces between the inner race and one of these sample rollers are shown in [Figure 7](#). Frictional energy dissipation rate due to the contact between the three sample rollers and inner race is shown in [Figure 8](#). Orbital motion of inner race is shown in [Figure 9](#).

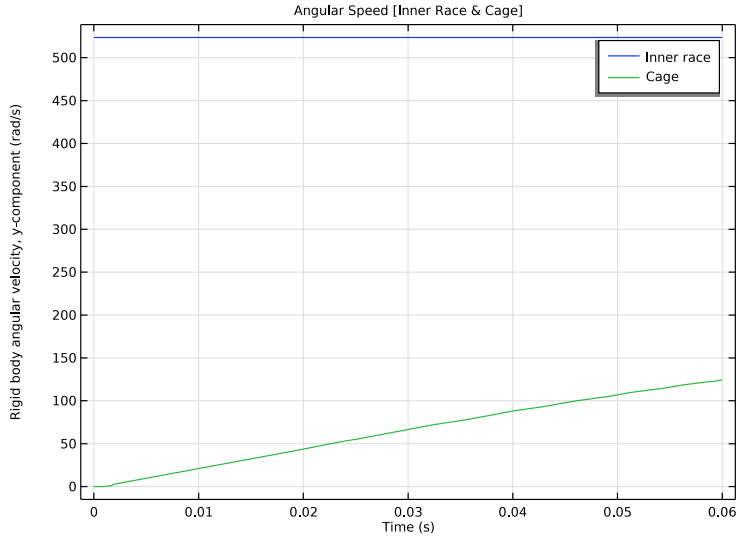

Figure 5: Angular speed of inner race and cage, as a function of time.

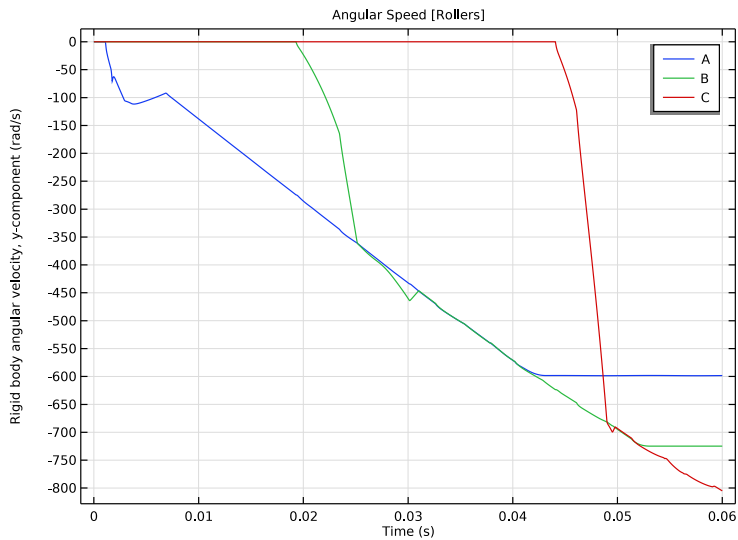

Figure 6: Angular speed of three sample rollers, as a function of time.

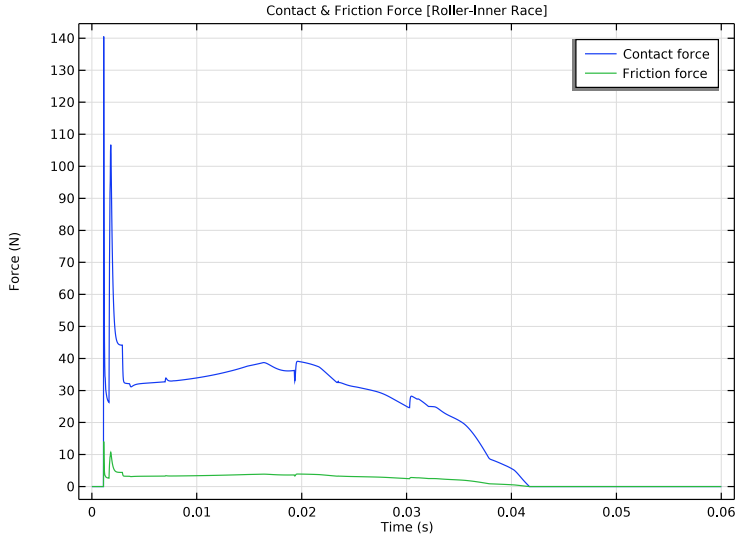

Figure 7: Contact and friction forces between a sample roller and inner race, as a function of time.

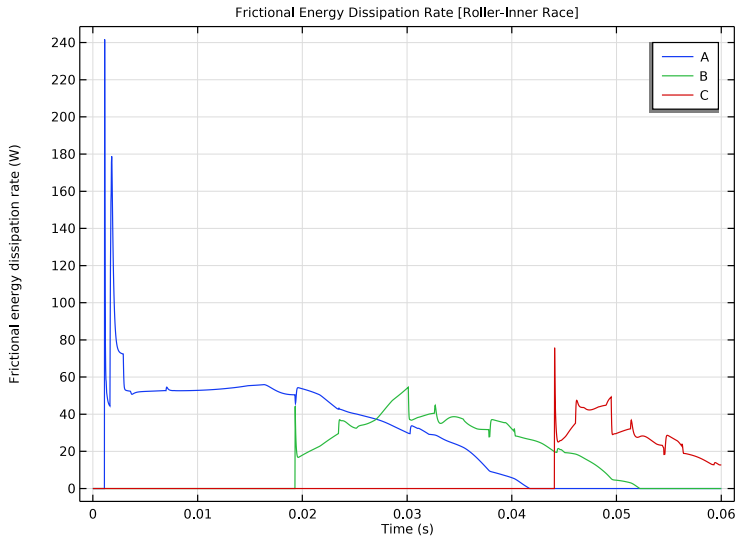

Figure 8: Frictional energy dissipation rate between three sample rollers and inner race, as a function of time.

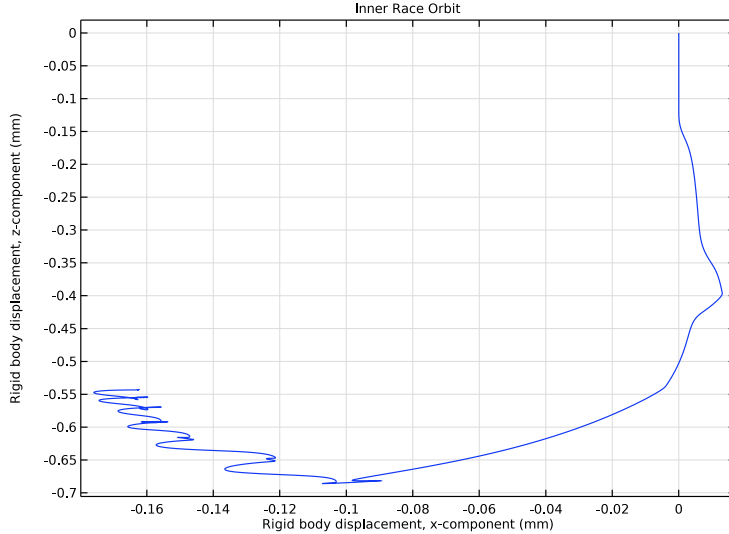

Figure 9: Orbital motion of inner race.

Notes About the COMSOL Implementation

- In this model, all components are modeled as rigid elements using the **Rigid Material** nodes which can be created automatically using the **Create Rigid Domains** button in the **Automated Model Setup** section at the physics interface.
- **Joint** nodes between rollers and cage can also be created automatically using the **Create Joints** button in the **Automated Model Setup** section at the physics interface. The automatic joint creation requires the geometry to be in assembly mode and **Identity Boundary Pair** nodes to be available in the **Definitions**.

Application Library path: Multibody_Dynamics_Module/Tutorials/
roller_bearing_dynamics



Modeling Instructions

From the **File** menu, choose **New**.

NEW

In the **New** window, click  **Model Wizard**.

MODEL WIZARD

- 1 In the **Model Wizard** window, click .
- 2 In the **Select Physics** tree, select **Structural Mechanics > Multibody Dynamics (mbd)**.
- 3 Click **Add**.
- 4 Click  **Study**.
- 5 In the **Select Study** tree, select **General Studies > Time Dependent**.
- 6 Click  **Done**.

GLOBAL DEFINITIONS

Parameters I



- 1 In the **Model Builder** window, under **Global Definitions** click **Parameters I**.
- 2 In the **Settings** window for **Parameters**, locate the **Parameters** section.
- 3 Click  **Load from File**.
- 4 Browse to the model's Application Libraries folder and double-click the file `roller_bearing_dynamics_parameters.txt`.

If you do not want to import the geometry and create selections, you can load the geometry sequence from the stored model. In the **Model Builder** window, under **Component I (comp1)** right-click **Geometry I** and choose **Insert Sequence**. Browse to the model's Application Libraries folder and double-click the file `roller_bearing_dynamics.mph`. You can then continue to the **Definitions** section below.



To import the geometry and create selections from scratch, continue here.

GEOMETRY I



Import I (imp1)

- 1 In the **Model Builder** window, expand the **Component I (comp1) > Geometry I** node.
- 2 Right-click **Geometry I** and choose **Import**.
- 3 In the **Settings** window for **Import**, locate the **Source** section.
- 4 Click  **Browse**.
- 5 Browse to the model's Application Libraries folder and double-click the file `roller_bearing_dynamics.mphbin`.
- 6 Click  **Import**.



Cage

- 1 In the **Geometry** toolbar, click  **Selections** and choose **Explicit Selection**.
- 2 In the **Settings** window for **Explicit Selection**, type **Cage** in the **Label** text field.
- 3 On the object **impl(2)**, select Domain 1 only.
- 4 Locate the **Color** section. From the **Color** list, choose **None** or — if you are running the cross-platform desktop —**Custom**. On the cross-platform desktop, click the **Color** button.
- 5 Click **Define custom colors**.
- 6 Set the RGB values to 255, 160, and 54, respectively.
- 7 Click **Add to custom colors**.
- 8 Click **Show color palette only** or **OK** on the cross-platform desktop.
- 9 Click  **Build Selected**.

Races



- 1 In the **Geometry** toolbar, click  **Selections** and choose **Explicit Selection**.
- 2 In the **Settings** window for **Explicit Selection**, type **Races** in the **Label** text field.
- 3 On the object **impl(1)**, select Domain 1 only.
- 4 On the object **impl(15)**, select Domains 1–4 only.
- 5 Locate the **Color** section. From the **Color** list, choose **None** or — if you are running the cross-platform desktop —**Custom**. On the cross-platform desktop, click the **Color** button.
- 6 Click **Define custom colors**.
- 7 Set the RGB values to 128, 128, and 128, respectively.
- 8 Click **Add to custom colors**.
- 9 Click **Show color palette only** or **OK** on the cross-platform desktop.
- 10 Click  **Build Selected**.

Rollers



- 1 In the **Geometry** toolbar, click  **Selections** and choose **Complement Selection**.
- 2 In the **Settings** window for **Complement Selection**, type **Rollers** in the **Label** text field.
- 3 Locate the **Input Entities** section. Click  **Add**.
- 4 In the **Add** dialog, in the **Selections to invert** list, choose **Cage** and **Races**.
- 5 Click **OK**.
- 6 In the **Settings** window for **Complement Selection**, locate the **Color** section.

- 7 From the **Color** list, choose **None** or — if you are running the cross-platform desktop — **Custom**. On the cross-platform desktop, click the **Color** button.
- 8 Click **Define custom colors**.
- 9 Set the RGB values to 113, 46, and 0, respectively.
- 10 Click **Add to custom colors**.
- 11 Click **Show color palette only** or **OK** on the cross-platform desktop.
- 12 Click  **Build Selected**.



Cage & Rollers

- 1 In the **Geometry** toolbar, click  **Selections** and choose **Union Selection**.
- 2 In the **Settings** window for **Union Selection**, type Cage & Rollers in the **Label** text field.
- 3 Locate the **Input Entities** section. Click  **Add**.
- 4 In the **Add** dialog, in the **Selections to add** list, choose **Cage** and **Rollers**.
- 5 Click **OK**.
- 6 In the **Settings** window for **Union Selection**, click  **Build Selected**.



Cage & Rollers Boundaries

- 1 In the **Geometry** toolbar, click  **Selections** and choose **Adjacent Selection**.
- 2 In the **Settings** window for **Adjacent Selection**, type Cage & Rollers Boundaries in the **Label** text field.
- 3 Locate the **Input Entities** section. Click  **Add**.
- 4 In the **Add** dialog, select **Cage & Rollers** in the **Input selections** list.
- 5 Click **OK**.
- 6 In the **Settings** window for **Adjacent Selection**, click  **Build Selected**.

Outer Race



- 1 In the **Geometry** toolbar, click  **Selections** and choose **Explicit Selection**.
- 2 In the **Settings** window for **Explicit Selection**, type Outer Race in the **Label** text field.
- 3 On the object **impl(15)**, select Domains 1–4 only.
- 4 Click  **Build Selected**.

Outer Race Boundaries





- 1 In the **Geometry** toolbar, click  **Selections** and choose **Adjacent Selection**.
- 2 In the **Settings** window for **Adjacent Selection**, type Outer Race Boundaries in the **Label** text field.
- 3 Locate the **Input Entities** section. Click  **Add**.

- 4 In the **Add** dialog, select **Outer Race** in the **Input selections** list.
- 5 Click **OK**.
- 6 In the **Settings** window for **Adjacent Selection**, locate the **Output Entities** section.
- 7 Select the **Interior boundaries** checkbox.
- 8 Click  **Build Selected**.

Boundaries without Outer Race

- 1 In the **Geometry** toolbar, click  **Selections** and choose **Complement Selection**.
- 2 In the **Settings** window for **Complement Selection**, type **Boundaries without Outer Race** in the **Label** text field.
- 3 Locate the **Geometric Entity Level** section. From the **Level** list, choose **Boundary**.
- 4 Locate the **Input Entities** section. Click  **Add**.
- 5 In the **Add** dialog, select **Outer Race Boundaries** in the **Selections to invert** list.
- 6 Click **OK**.
- 7 In the **Settings** window for **Complement Selection**, click  **Build Selected**.

Form Union (fin)

- 1 In the **Model Builder** window, under **Component 1 (comp1) > Geometry 1** click **Form Union (fin)**.
- 2 In the **Settings** window for **Form Union/Assembly**, locate the **Form Union/Assembly** section.
- 3 From the **Action** list, choose **Form an assembly**.
- 4 Click  **Build Selected**.
For better visualization, you can hide the top part of the outer race.
- 5 Click the  **Click and Hide** button in the **Graphics** toolbar.
- 6 In the **Graphics** window toolbar, click  next to  **Select Boundaries**, then choose **Select Domains**.
- 7 On the object **fin**, select Domain 1 only.

DEFINITIONS

Variables 1



- 1 In the **Model Builder** window, under **Component 1 (comp1)** right-click **Definitions** and choose **Variables**.
- 2 In the **Settings** window for **Variables**, locate the **Variables** section.
- 3 Click  **Load from File**.

- 4 Browse to the model's Application Libraries folder and double-click the file `roller_bearing_dynamics_variables.txt`.

Ramp 1 (rm1)

- 1 In the **Definitions** toolbar, click  **More Functions** and choose **Ramp**.
- 2 In the **Settings** window for **Ramp**, locate the **Parameters** section.
- 3 In the **Location** text field, type 0[s].
- 4 In the **Slope** text field, type 1000.
- 5 Select the **Cutoff** checkbox.

ADD MATERIAL

- 1 In the **Materials** toolbar, click  **Add Material** to open the **Add Material** window.
- 2 Go to the **Add Material** window.
- 3 In the tree, select **Built-in** > **Structural steel**.
- 4 Click the **Add to Component** button in the window toolbar.
- 5 In the **Materials** toolbar, click  **Add Material** to close the **Add Material** window.

MULTIBODY DYNAMICS (MBD)

Do as follows to generate **Rigid Material** nodes for all components.

- 1 In the **Settings** window for **Multibody Dynamics**, click **Physics Node Generation** in the upper-right corner of the **Automated Model Setup** section. From the menu, choose **Create Rigid Domains**.

Rigid Material 1: Outer Race

- 1 In the **Model Builder** window, expand the **Rigid Domains (All)** node, then click **Rigid Material 1**.
- 2 In the **Settings** window for **Rigid Material**, type Rigid Material 1: Outer Race in the **Label** text field.

Fixed Constraint 1

In the **Physics** toolbar, click  **Attributes** and choose **Fixed Constraint**.

Rigid Material 3: Cage

- 1 In the **Model Builder** window, under **Component 1 (comp1)** > **Multibody Dynamics (mbd)** > **Rigid Domains (All)** click **Rigid Material 3**.
- 2 In the **Settings** window for **Rigid Material**, type Rigid Material 3: Cage in the **Label** text field.

Prescribed Displacement/Rotation 1

- 1 In the **Physics** toolbar, click  **Attributes** and choose **Prescribed Displacement/Rotation**.
- 2 In the **Settings** window for **Prescribed Displacement/Rotation**, locate the **Prescribed Displacement at Center of Rotation** section.
- 3 Select the **Prescribed in y direction** checkbox.
- 4 Locate the **Prescribed Rotation** section. From the **By** list, choose **Constrained rotation**.
- 5 Select the **Constrain rotation around x-axis** checkbox.
- 6 Select the **Constrain rotation around z-axis** checkbox.

Rigid Material 6: Inner Race

- 1 In the **Model Builder** window, under **Component 1 (comp1) > Multibody Dynamics (mbd) > Rigid Domains (All)** click **Rigid Material 6**.
- 2 In the **Settings** window for **Rigid Material**, type Rigid Material 6: Inner Race in the **Label** text field.

Prescribed Displacement/Rotation 1

- 1 In the **Physics** toolbar, click  **Attributes** and choose **Prescribed Displacement/Rotation**.
- 2 In the **Settings** window for **Prescribed Displacement/Rotation**, locate the **Prescribed Displacement at Center of Rotation** section.
- 3 Select the **Prescribed in y direction** checkbox.
- 4 Locate the **Prescribed Rotation** section. From the **By** list, choose **Prescribed rotation**.
- 5 Specify the Ω vector as

0	x
1	y
0	z

- 6 In the ϕ_0 text field, type $\omega * t$.

Rigid Material 6: Inner Race

In the **Model Builder** window, click **Rigid Material 6: Inner Race**.

Applied Force 1

- 1 In the **Physics** toolbar, click  **Attributes** and choose **Applied Force**.
- 2 In the **Settings** window for **Applied Force**, locate the **Applied Force** section.

3 Specify the \mathbf{F} vector as

0	x
0	y
-load*rm1(t)	z

Do as follows to generate **Hinge Joint** nodes between rollers and cage.

- 4 In the **Model Builder** window, click **Multibody Dynamics (mbd)**.
- 5 In the **Settings** window for **Multibody Dynamics**, click **Physics Node Generation** in the upper-right corner of the **Automated Model Setup** section. From the menu, choose **Create Joints**.

Rigid Body Contact 1

- 1 In the **Physics** toolbar, click  **Global** and choose **Rigid Body Contact**.
- 2 In the **Settings** window for **Rigid Body Contact**, locate the **Source** section.
- 3 From the **Source** list, choose **Rigid Material 2**.
- 4 From the **Shape parameters** list, choose **User defined**.
- 5 In the r_s text field, type rr.
- 6 From the **Center** list, choose **Centroid of source**.
- 7 Locate the **Destination** section. From the **Destination** list, choose **Rigid Material 1: Outer Race**.
- 8 From the **Shape parameters** list, choose **User defined**.
- 9 In the r_d text field, type ro.
- 10 From the **Center** list, choose **Centroid of destination**.
- 11 Select the **Use inside boundaries for contact** checkbox.
- 12 Locate the **Contact Settings** section. In the f_p text field, type fp.
- 13 In the τ_n text field, type 1[ms]*10.

Friction 1

- 1 In the **Physics** toolbar, click  **Attributes** and choose **Friction**.
- 2 In the **Settings** window for **Friction**, locate the **Friction** section.
- 3 In the μ text field, type mu.
- 4 In the v_0 text field, type mbd.diag*1e-3[1/s]*10.

Roller-Outer Race Contact

Similarly create eleven more **Rigid Body Contact** nodes between rollers and outer race by duplicating **Rigid Body Contact 1** and resetting the inputs using the information given in the table below.

Name	Source	Destination
Rigid Body Contact 2	Rigid Material 4	Rigid Material 1: Outer Race
Rigid Body Contact 3	Rigid Material 5	Rigid Material 1: Outer Race
Rigid Body Contact 4	Rigid Material 7	Rigid Material 1: Outer Race
Rigid Body Contact 5	Rigid Material 8	Rigid Material 1: Outer Race
Rigid Body Contact 6	Rigid Material 9	Rigid Material 1: Outer Race
Rigid Body Contact 7	Rigid Material 10	Rigid Material 1: Outer Race
Rigid Body Contact 8	Rigid Material 11	Rigid Material 1: Outer Race
Rigid Body Contact 9	Rigid Material 12	Rigid Material 1: Outer Race
Rigid Body Contact 10	Rigid Material 13	Rigid Material 1: Outer Race
Rigid Body Contact 11	Rigid Material 14	Rigid Material 1: Outer Race
Rigid Body Contact 12	Rigid Material 15	Rigid Material 1: Outer Race

Rigid Body Contact 1, Rigid Body Contact 10, Rigid Body Contact 11, Rigid Body Contact 12, Rigid Body Contact 2, Rigid Body Contact 3, Rigid Body Contact 4, Rigid Body Contact 5, Rigid Body Contact 6, Rigid Body Contact 7, Rigid Body Contact 8, Rigid Body Contact 9

1 In the **Model Builder** window, under **Component 1 (comp1) > Multibody Dynamics (mbd)**, Ctrl-click to select **Rigid Body Contact 1, Rigid Body Contact 2, Rigid Body Contact 3, Rigid Body Contact 4, Rigid Body Contact 5, Rigid Body Contact 6, Rigid Body Contact 7, Rigid Body Contact 8, Rigid Body Contact 9, Rigid Body Contact 10, Rigid Body Contact 11,** and **Rigid Body Contact 12.**

2 Right-click and choose **Group.**

Roller-Outer Race Contact

In the **Settings** window for **Group**, type **Roller-Outer Race Contact** in the **Label** text field.

Add **Rigid Body Contact** nodes between rollers and inner race by duplicating **Roller-Outer Race Contact** and resetting the input values.

Roller-Inner Race Contact

1 Right-click **Roller-Outer Race Contact** and choose **Duplicate.**

- 2 In the **Settings** window for **Group**, type Roller - Inner Race Contact in the **Label** text field.

Rigid Body Contact 13

- 1 In the **Model Builder** window, expand the **Roller-Inner Race Contact** node, then click **Rigid Body Contact 13**.
- 2 In the **Settings** window for **Rigid Body Contact**, locate the **Destination** section.
- 3 From the **Destination** list, choose **Rigid Material 6: Inner Race**.
- 4 Clear the **Use inside boundaries for contact** checkbox.
- 5 In the r_d text field, type r_i .

Roller-Inner Race Contact

- 1 Similar to the changes done for **Rigid Body Contact 13**, reset the inputs of other eleven **Rigid Body Contact** nodes using the information given in the table below.

Name	Source	Destination
Rigid Body Contact 14	Rigid Material 4	Rigid Material 6: Inner Race
Rigid Body Contact 15	Rigid Material 5	Rigid Material 6: Inner Race
Rigid Body Contact 16	Rigid Material 7	Rigid Material 6: Inner Race
Rigid Body Contact 17	Rigid Material 8	Rigid Material 6: Inner Race
Rigid Body Contact 18	Rigid Material 9	Rigid Material 6: Inner Race
Rigid Body Contact 19	Rigid Material 10	Rigid Material 6: Inner Race
Rigid Body Contact 20	Rigid Material 11	Rigid Material 6: Inner Race
Rigid Body Contact 21	Rigid Material 12	Rigid Material 6: Inner Race
Rigid Body Contact 22	Rigid Material 13	Rigid Material 6: Inner Race
Rigid Body Contact 23	Rigid Material 14	Rigid Material 6: Inner Race
Rigid Body Contact 24	Rigid Material 15	Rigid Material 6: Inner Race

In order to visualize the motion of the system with respect to the cage frame, you can use the option of defining a reference frame available in the **Multibody Dynamics** interface and plot the postprocessing variables for velocity with respect to the reference frame.

- 2 In the **Model Builder** window, click **Multibody Dynamics (mbd)**.
- 3 In the **Settings** window for **Multibody Dynamics**, click to expand the **Results** section.
- 4 From the **Body defining reference frame** list, choose **Rigid Material 3: Cage**.

MESH 1

- 1 In the **Model Builder** window, under **Component 1 (comp1)** click **Mesh 1**.



- 2 In the **Settings** window for **Mesh**, locate the **Physics-Controlled Mesh** section.
- 3 From the **Element size** list, choose **Fine**.
- 4 Click  **Build All**.

STUDY I

Step 1: Time Dependent

- 1 In the **Model Builder** window, under **Study I** click **Step 1: Time Dependent**.
- 2 In the **Settings** window for **Time Dependent**, locate the **Study Settings** section.
- 3 In the **Output times** text field, type range (0, T/500, 5*T).

Solution 1 (sol1)

- 1 In the **Study** toolbar, click  **Show Default Solver**.
- 2 In the **Model Builder** window, expand the **Solution 1 (sol1)** node.
- 3 In the **Model Builder** window, expand the **Study I > Solver Configurations > Solution 1 (sol1) > Time-Dependent Solver 1** node, then click **Fully Coupled 1**.
- 4 In the **Settings** window for **Fully Coupled**, click to expand the **Method and Termination** section.
- 5 In the **Maximum number of iterations** text field, type 15.
- 6 In the **Model Builder** window, under **Study I > Solver Configurations > Solution 1 (sol1)** click **Time-Dependent Solver 1**.
- 7 In the **Settings** window for **Time-Dependent Solver**, click to expand the **Time Stepping** section.
- 8 From the **Steps taken by solver** list, choose **Intermediate**.
- 9 In the **Study** toolbar, click  **Compute**.

RESULTS

Click the  **Show Grid** button in the **Graphics** toolbar.

Follow the instructions below to plot system displacement as shown in [Figure 2](#).

Displacement (mbd)

- 1 In the **Model Builder** window, under **Results** click **Displacement (mbd)**.
- 2 In the **Settings** window for **3D Plot Group**, locate the **Plot Settings** section.
- 3 Select the **Propagate hiding to lower dimensions** checkbox.
- 4 In the **Model Builder** window, expand the **Displacement (mbd)** node.

Selection 1

- 1 In the **Model Builder** window, expand the **Results > Displacement (mbd) > Surface** node.
- 2 Right-click **Surface** and choose **Selection**.
- 3 In the **Settings** window for **Selection**, locate the **Selection** section.
- 4 From the **Selection** list, choose **Boundaries without Outer Race**.



Surface 2

- 1 In the **Model Builder** window, right-click **Surface** and choose **Duplicate**.
- 2 In the **Settings** window for **Surface**, click to expand the **Title** section.
- 3 From the **Title type** list, choose **None**.
- 4 Locate the **Coloring and Style** section. From the **Coloring** list, choose **Uniform**.
- 5 From the **Color** list, choose **Gray**.

Transparency 1

Right-click **Surface 2** and choose **Transparency**.

Selection 1

- 1 In the **Settings** window for **Selection**, locate the **Selection** section.
- 2 Click to select the  **Activate Selection** toggle button.
- 3 From the **Selection** list, choose **Outer Race Boundaries**.
- 4 In the **Displacement (mbd)** toolbar, click  **Plot**.

Follow the instructions below to plot contact force and velocity. The resulting plot should match the one shown in [Figure 3](#).

Contact Force & Velocity

- 1 In the **Model Builder** window, under **Results** click **Velocity (mbd)**.
- 2 In the **Settings** window for **3D Plot Group**, type Contact Force & Velocity in the **Label** text field.
- 3 Click to expand the **Selection** section. Locate the **Plot Settings** section. From the **View** list, choose **New view**.

Arrow Line

- 1 In the **Model Builder** window, expand the **Contact Force & Velocity** node.
- 2 Right-click **Arrow Line** and choose **Delete**.

Domain Numbers

- 1 In the **Settings** window for **Volume**, locate the **Coloring and Style** section.

- 2 From the **Coloring** list, choose **Uniform**.
- 3 From the **Color** list, choose **Gray**.
- 4 Click to expand the **Title** section. From the **Title type** list, choose **None**.

Transparency I

Right-click **Domain Numbers** and choose **Transparency**.

Selection I

- 1 Right-click **Domain Numbers** and choose **Selection**.
- 2 In the **Settings** window for **Selection**, locate the **Selection** section.
- 3 From the **Selection** list, choose **Races**.
- 4 In the list, choose **2** and **3**.
- 5 Click  **Remove from Selection**.
- 6 Select Domains 1, 4, and 9 only.

Surface I

- 1 In the **Model Builder** window, right-click **Contact Force & Velocity** and choose **Surface**.
- 2 In the **Settings** window for **Surface**, locate the **Expression** section.
- 3 In the **Expression** text field, type `mbd.vel`.
- 4 Locate the **Coloring and Style** section. From the **Color table** list, choose **HeatCameraLight**.

Deformation I

- 1 Right-click **Surface I** and choose **Deformation**.
- 2 In the **Settings** window for **Deformation**, locate the **Scale** section.
- 3 Select the **Scale factor** checkbox. In the associated text field, type 1.

Selection I

- 1 In the **Model Builder** window, right-click **Surface I** and choose **Selection**.
- 2 In the **Settings** window for **Selection**, locate the **Selection** section.
- 3 From the **Selection** list, choose **Cage & Rollers Boundaries**.

Arrow Surface I

- 1 In the **Model Builder** window, right-click **Contact Force & Velocity** and choose **Arrow Surface**.
- 2 In the **Settings** window for **Arrow Surface**, locate the **Expression** section.
- 3 In the **X-component** text field, type `Fnx`.
- 4 In the **Y-component** text field, type `Fny`.

- 5 In the **Z-component** text field, type F_{nz} .
- 6 Select the **Description** checkbox. In the associated text field, type Contact force (N).
- 7 Locate the **Coloring and Style** section.
- 8 Select the **Scale factor** checkbox. In the associated text field, type $5e-4$.
- 9 From the **Color** list, choose **Green**.

Deformation 1

- 1 Right-click **Arrow Surface 1** and choose **Deformation**.
- 2 In the **Settings** window for **Deformation**, locate the **Scale** section.
- 3 Select the **Scale factor** checkbox. In the associated text field, type 1.

Selection 1

- 1 In the **Model Builder** window, right-click **Arrow Surface 1** and choose **Selection**.
- 2 In the **Settings** window for **Selection**, locate the **Selection** section.
- 3 From the **Selection** list, choose **Cage & Rollers Boundaries**.
- 4 In the **Contact Force & Velocity** toolbar, click  **Plot**.

Follow the instructions below to plot the velocity with respect to cage frame. The resulting plot should match the one shown in [Figure 4](#).

Velocity [Cage Frame]

- 1 In the **Model Builder** window, right-click **Contact Force & Velocity** and choose **Duplicate**.
- 2 In the **Settings** window for **3D Plot Group**, type Velocity [Cage Frame] in the **Label** text field.

Surface 1

- 1 In the **Model Builder** window, expand the **Velocity [Cage Frame]** node, then click **Surface 1**.
- 2 In the **Settings** window for **Surface**, locate the **Expression** section.
- 3 In the **Expression** text field, type `mbd.vel_ref`.

Arrow Surface 1

In the **Model Builder** window, right-click **Arrow Surface 1** and choose **Delete**.

Velocity [Cage Frame]

Follow the instructions below to plot angular speed of inner race and cage. The resulting plot should match the one shown in [Figure 5](#).

Angular Speed [Inner Race & Cage]

- 1 In the **Results** toolbar, click  **ID Plot Group**.
- 2 In the **Settings** window for **ID Plot Group**, type Angular Speed [Inner Race & Cage] in the **Label** text field.
- 3 Click to expand the **Title** section. From the **Title type** list, choose **Label**.

Global 1

- 1 Right-click **Angular Speed [Inner Race & Cage]** and choose **Global**.
- 2 In the **Settings** window for **Global**, locate the **y-Axis Data** section.
- 3 In the table, enter the following settings:

Expression	Unit	Description
mbd.rd6.th_ty	rad/s	Rigid body angular velocity, y-component
mbd.rd3.th_ty	rad/s	Rigid body angular velocity, y-component

- 4 Click to expand the **Legends** section. From the **Legends** list, choose **Manual**.
- 5 In the table, enter the following settings:

Legends
Inner race
Cage

- 6 In the **Angular Speed [Inner Race & Cage]** toolbar, click  **Plot**.

Follow the instructions below to plot angular speed of rollers. The resulting plot should match the one shown in [Figure 6](#).

Angular Speed [Rollers]

- 1 In the **Model Builder** window, right-click **Angular Speed [Inner Race & Cage]** and choose **Duplicate**.
- 2 In the **Settings** window for **ID Plot Group**, type Angular Speed [Rollers] in the **Label** text field.

Global 1

- 1 In the **Model Builder** window, expand the **Angular Speed [Rollers]** node, then click **Global 1**.
- 2 In the **Settings** window for **Global**, locate the **y-Axis Data** section.

3 In the table, enter the following settings:

Expression	Unit	Description
mbd.rd11.th_ty	rad/s	Rigid body angular velocity, y-component
mbd.rd15.th_ty	rad/s	Rigid body angular velocity, y-component
mbd.rd10.th_ty	rad/s	Rigid body angular velocity, y-component

4 In the **Angular Speed [Rollers]** toolbar, click  **Plot**.

5 Locate the **Legends** section. In the table, enter the following settings:

Legends
A
B
C

6 In the **Angular Speed [Rollers]** toolbar, click  **Plot**.

Follow the instructions below to plot contact and friction force between roller and inner race. The resulting plot should match the one shown in [Figure 7](#).

Contact & Friction Force [Roller-Inner Race]

- 1 In the **Model Builder** window, right-click **Angular Speed [Rollers]** and choose **Duplicate**.
- 2 In the **Settings** window for **ID Plot Group**, type Contact & Friction Force [Roller-Inner Race] in the **Label** text field.

Global 1

- 1 In the **Model Builder** window, expand the **Contact & Friction Force [Roller-Inner Race]** node, then click **Global 1**.
- 2 In the **Settings** window for **Global**, locate the **y-Axis Data** section.
- 3 Click  **Clear Table**.
- 4 In the table, enter the following settings:

Expression	Unit	Description
mbd.rbc20.Fn	N	Contact force
mbd.rbc20.Ff	N	Friction force

5 Locate the **Legends** section. From the **Legends** list, choose **Automatic**.

Contact & Friction Force [Roller-Inner Race]

- 1 In the **Model Builder** window, click **Contact & Friction Force [Roller-Inner Race]**.

- 2 In the **Settings** window for **ID Plot Group**, locate the **Plot Settings** section.
- 3 Select the **y-axis label** checkbox. In the associated text field, type Force (N).
- 4 In the **Contact & Friction Force [Roller-Inner Race]** toolbar, click  **Plot**.

Follow the instructions below to plot frictional energy dissipation rate between rollers and inner race. The resulting plot should match the one shown in [Figure 8](#).

Frictional Energy Dissipation Rate [Roller-Inner Race]

- 1 Right-click **Contact & Friction Force [Roller-Inner Race]** and choose **Duplicate**.
- 2 In the **Settings** window for **ID Plot Group**, type Frictional Energy Dissipation Rate [Roller-Inner Race] in the **Label** text field.

Global 1

- 1 In the **Model Builder** window, expand the **Frictional Energy Dissipation Rate [Roller-Inner Race]** node, then click **Global 1**.
- 2 In the **Settings** window for **Global**, locate the **y-Axis Data** section.
- 3 Click  **Clear Table**.
- 4 In the table, enter the following settings:

Expression	Unit	Description
mbd.rbc20.Qf	W	Frictional energy dissipation rate
mbd.rbc24.Qf	W	Frictional energy dissipation rate
mbd.rbc19.Qf	W	Frictional energy dissipation rate

- 5 Locate the **Legends** section. From the **Legends** list, choose **Manual**.
- 6 In the table, enter the following settings:

Legends
A
B
C

Frictional Energy Dissipation Rate [Roller-Inner Race]

- 1 In the **Model Builder** window, click **Frictional Energy Dissipation Rate [Roller-Inner Race]**.
- 2 In the **Settings** window for **ID Plot Group**, locate the **Plot Settings** section.
- 3 Clear the **y-axis label** checkbox.
- 4 In the **Frictional Energy Dissipation Rate [Roller-Inner Race]** toolbar, click  **Plot**.

Follow the instructions below to plot inner race orbit. The resulting plot should match the one shown in [Figure 9](#).

Inner Race Orbit

- 1 Right-click **Frictional Energy Dissipation Rate [Roller-Inner Race]** and choose **Duplicate**.
- 2 In the **Settings** window for **ID Plot Group**, type Inner Race Orbit in the **Label** text field.

Global I

- 1 In the **Model Builder** window, expand the **Inner Race Orbit** node, then click **Global I**.
- 2 In the **Settings** window for **Global**, locate the **y-Axis Data** section.
- 3 Click  **Clear Table**.
- 4 In the table, enter the following settings:

Expression	Unit	Description
mbd.rd6.w	mm	Rigid body displacement, z-component

- 5 Locate the **Legends** section. Clear the **Show legends** checkbox.
- 6 Locate the **x-Axis Data** section. From the **Parameter** list, choose **Expression**.
- 7 In the **Expression** text field, type mbd.rd6.u.
- 8 From the **Unit** list, choose **mm**.

Inner Race Orbit

- 1 In the **Model Builder** window, click **Inner Race Orbit**.
- 2 In the **Inner Race Orbit** toolbar, click  **Plot**.

Displacement (mbd)

- 1 In the **Results** toolbar, click  **Animation** and choose **Player**.
- 2 In the **Settings** window for **Animation**, type Displacement (mbd) in the **Label** text field.
- 3 Locate the **Frames** section. In the **Number of frames** text field, type 100.

Contact Force & Velocity

- 1 Right-click **Displacement (mbd)** and choose **Duplicate**.
- 2 In the **Settings** window for **Animation**, type Contact Force & Velocity in the **Label** text field.
- 3 Locate the **Scene** section. From the **Subject** list, choose **Contact Force & Velocity**.

Velocity [Cage Frame]

- 1 Right-click **Contact Force & Velocity** and choose **Duplicate**.

- 2 In the **Settings** window for **Animation**, type Velocity [Cage Frame] in the **Label** text field.
- 3 Locate the **Scene** section. From the **Subject** list, choose **Velocity [Cage Frame]**.