



Model created in COMSOL Multiphysics 6.4

# Stress Analysis of a Roller Chain Sprocket Assembly

## Introduction

---

Chain drives are used for transmitting power from one shaft to another, located at some distance. This example demonstrates how to model a chain sprocket assembly in 3D. The geometry consists of a roller chain wrapped around two sprockets. All components are assumed to be elastic. The system dynamics is initiated by an angular velocity prescribed at one of the sprockets. The motion is transmitted via chain links to the second sprocket which is subjected to an external, counteracting torque.

The chain sprocket assembly geometry is created using built-in geometry parts. The **Chain Drive** node in the Multibody Dynamics interface is used for setting up the entire model. A transient analysis is performed to understand the load path, the contact forces and the stress distribution in various components of the assembly.

## Model Definition

---

The geometry consists of an assembly of a chain wrapped around two sprockets in 3D, as shown in [Figure 1](#). The chain is assumed to be of roller type, and composed of a number of link plates. A typical roller chain has two different types of link plates: roller plates and pin plates.

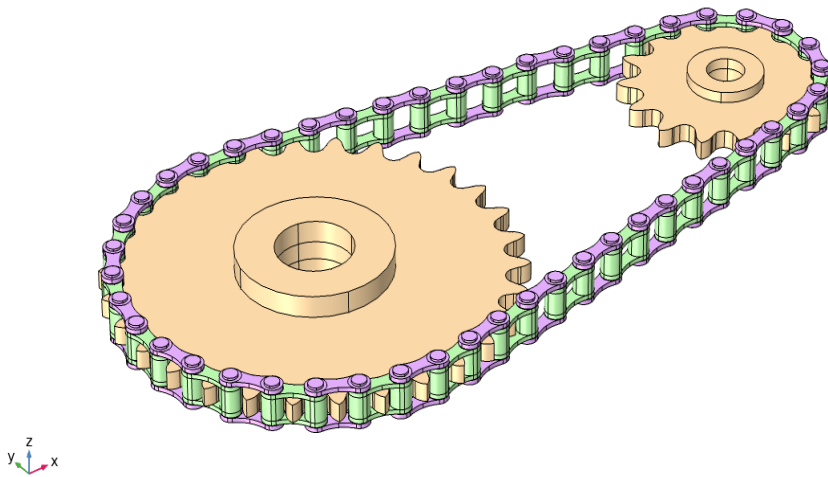

*Figure 1: Geometry of a roller chain sprocket assembly.*

[Figure 2](#) shows an exploded view of a sample link connection. A roller plate is made of two hollow cylinders connected to side plates. A pin plate consists of two solid cylinders and

two side plates. The link connection permits relative rotation between the two link plates, and the relative rotation is modeled using hinged joints. Elastic bushings are sometimes used to reduce vibrations in the system, but they are not included in this analysis.

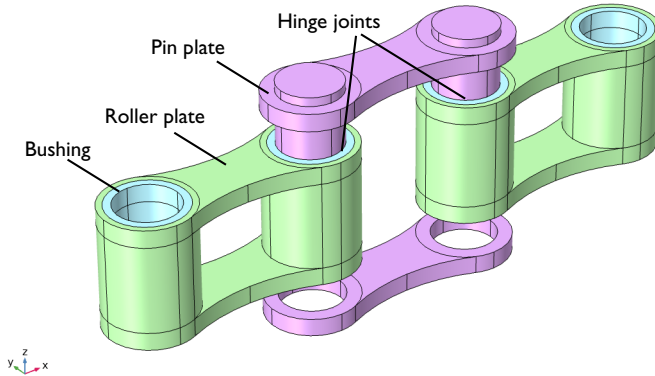

Figure 2: Exploded view of the chain link connection. The connection between links is formed by inserting the pin plates into the hollow roller plate cylinders.

#### CHAIN AND SPROCKET PARAMETERS

The distance between two adjacent links is called *pitch*. In this example, the pitch is 0.25 in. All other geometric dimensions of link plates are taken as standard and parameterized as a function of the pitch. Table 1 lists the chain parameters.

The two sprockets have 30 and 15 teeth, respectively. They are located at a distance of 3 in. Each sprocket has a bore at its center, which enables mounting of the sprocket on other mechanical components such as shafts. Table 2 lists the sprocket parameters.

TABLE 1: CHAIN PARAMETERS

PARAMETER	NAME	VALUE
Pitch	$p$	0.25 in
Roller diameter to pitch ratio	$D_r$	0.52
Pin diameter to pitch ratio	$D_p$	0.362
Bushing diameter to pitch ratio	$D_b$	0.45
Minimum link plate width to roller diameter ratio	$W_1$	0.6
Thickness to pitch ratio of roller plates ( $r$ ) and pin plates ( $p$ )	$t_r, t_p$	0.1

TABLE 2: SPROCKET PARAMETERS

PARAMETER	NAME	VALUE
Pitch	p	0.25 in
Number of teeth, first sprocket	n1	30
Number of teeth, second sprocket	n2	15
Sprockets center distance	cdx	3 in
Sprocket width to pitch ratio	W	0.5
Sprocket clearance to pitch ratio	c1rsp	0.05
Bore diameter to pitch diameter ratio of both sprockets	Dbr	0.2
Hub diameter to pitch diameter ratio of both sprockets	Dh	0.4
Hub width to pitch ratio for upside and downside of both sprockets	Wh	0.1

### MATERIALS

Both the chain and the sprockets are made of structural steel. All components are assumed to be elastic.

### CHAIN DRIVE

The assembly of the chain and the sprockets is modeled using the **Chain Drive** node. For a selected geometry part, this node automatically creates attachments, hinge joints, and contact pairs that can be used to analyze the roller chain assembly.

### SELECTION SETTINGS

For automatic generation of physics nodes, you need to select a geometry of the chain sprocket assembly from the **Part Library** of COMSOL Multiphysics. You can also create your own geometry; however, the geometry requires domain and boundary selections to be used as inputs for automatic creation of other physics nodes. In this example, the following selections are used to create physics nodes using the **Chain Drive** node.

- **Pin Outer Boundaries:** This is a boundary selection containing the outer cylindrical surfaces of all the pin plates. The selection is used for creating **Attachment** nodes for each of the pin plates.
- **Roller Inner Boundaries:** This is a boundary selection containing inner cylindrical surfaces of all the roller plates. This selection is used for creating **Attachment** nodes for each of the roller plates. The selection coincides geometrically with the Pin Outer

Boundaries (Figure 3). The attachments for the pin and roller plates are used as **Source** and **Destination** in **Hinge Joint** nodes.

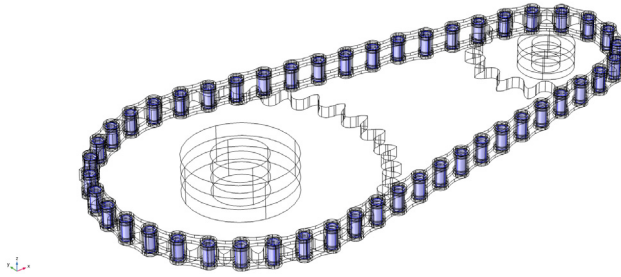

*Figure 3: The Pin Outer Boundaries (also Roller Inner Boundaries) selection for creating attachments.*

- Roller Outer Boundaries: This boundary selection contains the outer cylindrical surfaces of all the roller plates. The selection is used for creating **Contact Pair** nodes for modeling contact between links and sprockets, as shown in Figure 4.
- Sprocket Outer Boundaries: This boundary selection contains the outer surfaces of the sprockets. The selection is used for creating a **Contact Pair** for modeling contact between links and sprockets as shown in Figure 4.

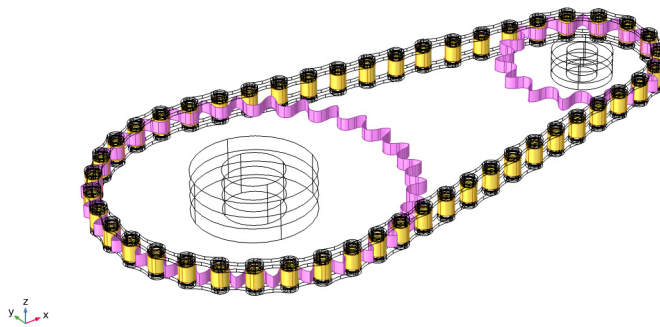

*Figure 4: Contact between the Roller Outer Boundaries and Sprocket Outer Boundaries.*

- **Sprocket Inner Boundaries:** This boundary selection contains the inner surfaces of the sprockets, as shown in [Figure 5](#). It is used for creating attachments and hinge joints for mounting the sprockets onto shafts.

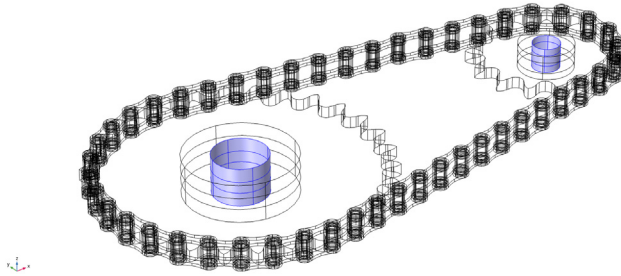

*Figure 5: The Sprocket Inner Boundaries selection for creating attachments and hinge joints to mount the sprockets onto shafts.*

Additional details about **Chain Drive** functionality can be found in the *Multibody Dynamics Module User's Guide*.

#### **BOUNDARY CONDITIONS**

An angular velocity of 1 rad/s is prescribed on the left sprocket, which acts as a driver for the mechanism. On the driven sprocket, a counteracting torque of 0.01 Nm is applied.

A swept mesh is created for both the sprockets and the chain links, as shown in [Figure 6](#)

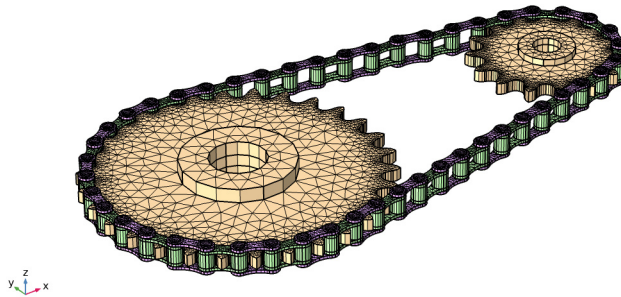

*Figure 6: Swept mesh for the sprockets and the chain links.*

## STUDY

A Time Dependent study is used to analyze the chain drive. The analysis is performed for a duration of 0.1 s. The load path, contact forces, and stress distribution, in various components of the chain drive, are analyzed.

## Results and Discussion

---

Figure 7 shows the total displacement of the sprockets and the chain links surfaces, at  $t = 0.1$  s.

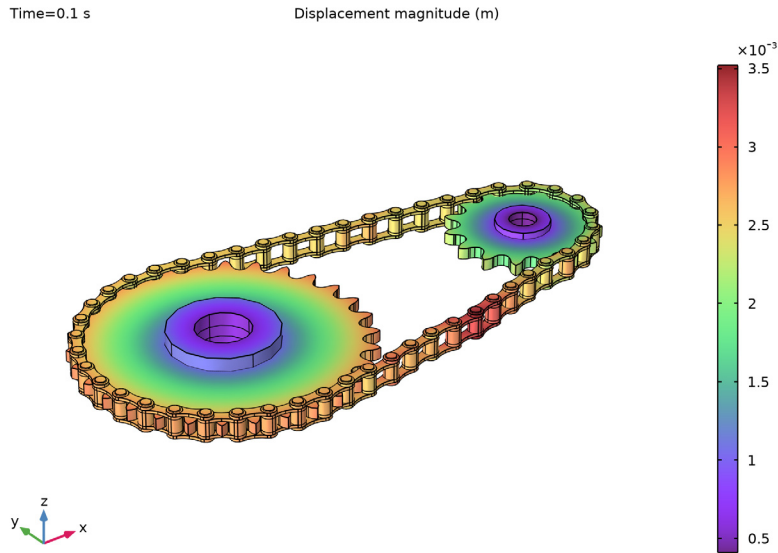

Figure 7: The displacement of the sprockets and the chain links, at  $t = 0.1$  s.

The stress state in the chain drive is shown in Figure 8. The figure shows that the links at the top side are under tension and experience higher stresses compared to the links at the bottom. The stresses in the sprocket are shown separately in Figure 9. To understand the local stress distribution in chain links that are under tension, two sample links from the top side are used. Figure 10 shows the von Mises stress distribution for these.

The contact dynamics between the sprockets and the chain outer boundaries is modeled using the penalty method. This method is based on a penalty factor, where penetration of structural components in contact is prevented by introducing a spring stiffness. Figure 11 shows the distribution of contact pressure on the outer boundaries of the driver sprocket.

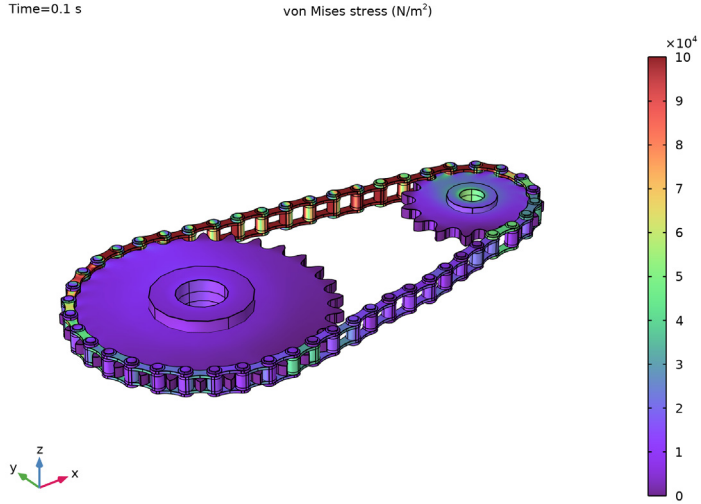

Figure 8: The von Mises stress distribution in the chain drive, at  $t = 0.1$  s

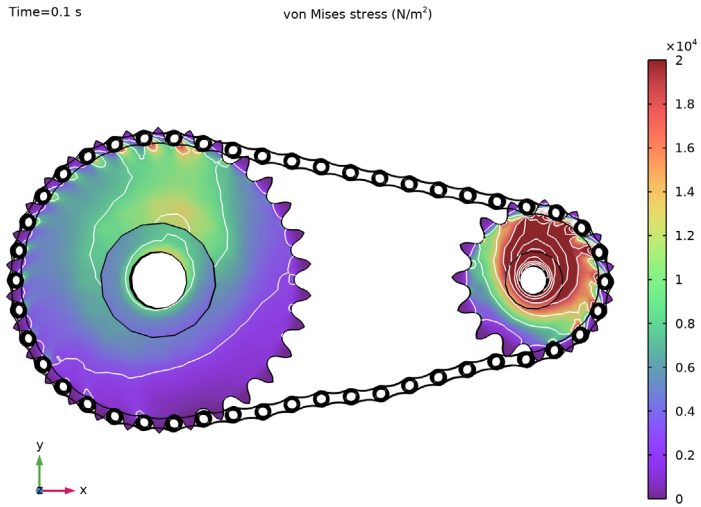

Figure 9: The von Mises stress distribution in the sprockets, at  $t = 0.1$  s

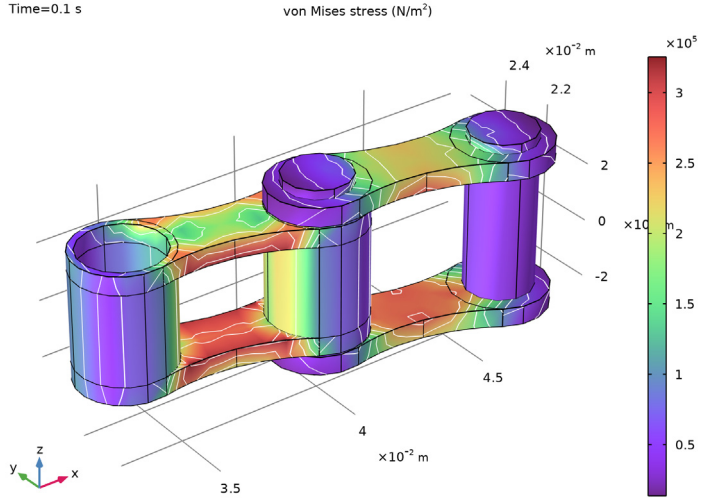

Figure 10: The von Mises stress distribution for chain links under tension, at  $t = 0.1$  s.

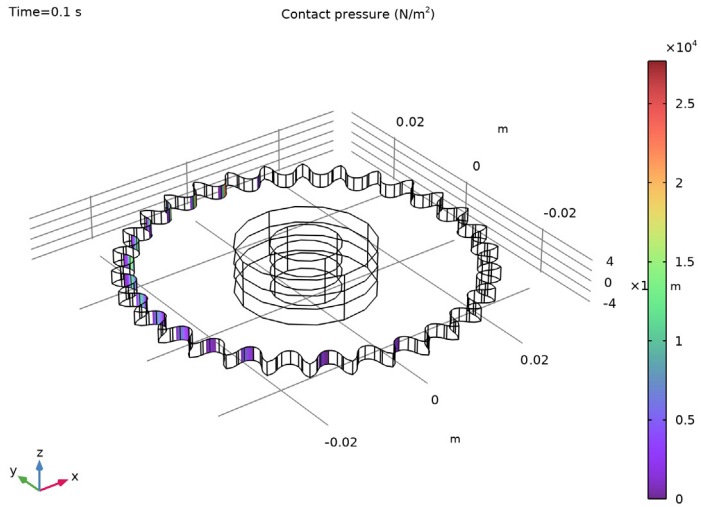

Figure 11: The distribution of contact pressure on outer surfaces of the driver sprocket, at  $t = 0.1$  s.

In order to understand the variation of joint forces over time, four links in the chain are examined. These links are taken from four different locations along the chain: The first link is initially situated at the top tension side of the chain. The second and third links are initially in contact with the sprocket outer boundaries. The initial position of the fourth link is at the bottom slack side of the chain. Figure 12 plots the joint forces for these links, as a function of time.

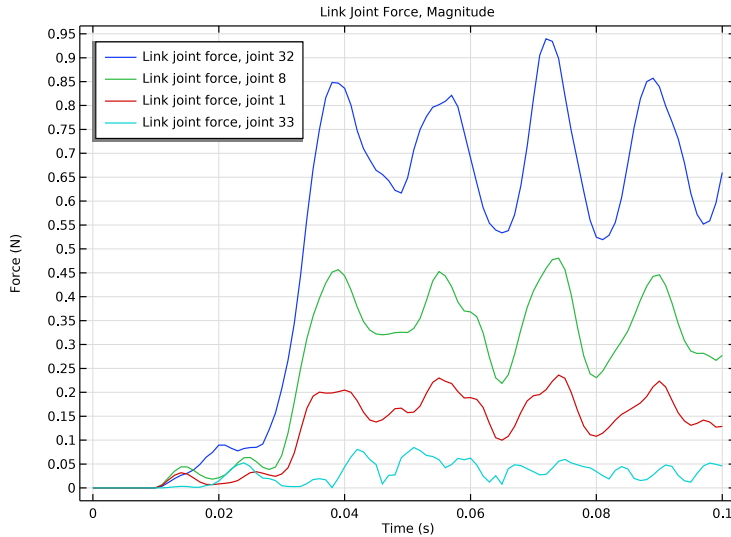

Figure 12: Link joint force as a function of time.

### Notes About the COMSOL Implementation

- To build a chain drive system geometry, you can import a roller chain sprocket assembly part from the **Part Library**, and customize it by changing its input parameters.
- The **Chain Drive** node operates on the geometry in the assembly state.
- The **Chain Drive** node creates new physics nodes from selections available in the geometry. If you are using a part imported from the **Part Library**, select the checkbox in **Geometry** to keep noncontributing selections. If you are building a geometry of a roller chain and sprocket assembly, you also need to create appropriate selections for the **Chain Drive** node to operate.
- When one or more selection inputs of the **Chain Drive** node change, the selections of the physics nodes created by **Chain Drive** node also change. Hence, these nodes have to be deleted and recreated. This is indicated by a warning node appearing under the **Chain Drive** node. In that case, you need to press the **Create Links and Joints** button. This will

automatically create new groups of physics nodes in accordance with the changed selection inputs.

---

**Application Library path:** Multibody\_Dynamics\_Module/Tutorials, \_Transmission/elastic\_roller\_chain

---

### *Modeling Instructions*



---

From the **File** menu, choose **New**.

#### **NEW**

In the **New** window, click  **Model Wizard**.

#### **MODEL WIZARD**

- 1 In the **Model Wizard** window, click  **3D**.
- 2 In the **Select Physics** tree, select **Structural Mechanics > Multibody Dynamics (mbd)**.
- 3 Click **Add**.
- 4 Click  **Study**.
- 5 In the **Select Study** tree, select **General Studies > Time Dependent**.
- 6 Click  **Done**.

#### **GLOBAL DEFINITIONS**

##### *Parameters I*

- 1 In the **Model Builder** window, under **Global Definitions** click **Parameters I**.
- 2 In the **Settings** window for **Parameters**, locate the **Parameters** section.
- 3 In the table, enter the following settings:

<b>Name</b>	<b>Expression</b>	<b>Value</b>	<b>Description</b>
omega	1[rad/s]	1 rad/s	Angular velocity of drive shaft
T_ext	0.01[N*m]	0.01 N·m	External torque
pc	1.5e8[N/m^3]	1.5E8 N/m <sup>3</sup>	Penalty factor

## DEFINITIONS



### Step 1 (step1)

- 1 In the **Definitions** toolbar, click  **More Functions** and choose **Step**.
- 2 In the **Settings** window for **Step**, locate the **Parameters** section.
- 3 In the **Location** text field, type 0.01 [s].
- 4 Click to expand the **Smoothing** section. In the **Size of transition zone** text field, type 0.02.

### Step 2 (step2)

- 1 Right-click **Step 1 (step1)** and choose **Duplicate**.
- 2 In the **Settings** window for **Step**, locate the **Parameters** section.
- 3 In the **Location** text field, type 0.03 [s].

## PART LIBRARIES

- 1 In the **Home** toolbar, click  **Windows** and choose **Part Libraries**.
- 2 In the **Part Libraries** window, select **Multibody Dynamics Module > 3D > Roller Chains > roller\_chain\_sprocket\_assembly** in the tree.
- 3 Click  **Add to Geometry**.
- 4 In the **Select Part Variant** dialog, select **Specify sprocket center distance** in the **Select part variant** list.
- 5 Click **OK**.

## GEOMETRY I

### Roller Chain Sprocket I (pi1)

- 1 In the **Model Builder** window, under **Component 1 (comp1) > Geometry 1** click **Roller Chain Sprocket I (pi1)**.
- 2 In the **Settings** window for **Part Instance**, locate the **Selection Settings** section.
- 3 Select the **Keep noncontributing selections** checkbox.
- 4 Click  **Build Selected**.

### Form Union (fin)

- 1 In the **Model Builder** window, under **Component 1 (comp1) > Geometry 1** click **Form Union (fin)**.
- 2 In the **Settings** window for **Form Union/Assembly**, locate the **Form Union/Assembly** section.
- 3 From the **Action** list, choose **Form an assembly**.

4 Clear the **Create pairs** checkbox.

5 Click  **Build Selected**.

Disable the analysis of the geometry as the remaining small geometric details can be kept.

6 In the **Model Builder** window, click **Geometry 1**.

7 In the **Settings** window for **Geometry**, locate the **Cleanup** section.

8 Clear the **Automatic detection of small details** checkbox.

#### ADD MATERIAL

1 In the **Materials** toolbar, click  **Add Material** to open the **Add Material** window.

2 Go to the **Add Material** window.

3 In the tree, select **Built-in > Structural steel**.

4 Click the **Add to Component** button in the window toolbar.

5 In the **Materials** toolbar, click  **Add Material** to close the **Add Material** window.

#### MULTIBODY DYNAMICS (MBD)

##### *Chain Drive 1*

1 In the **Physics** toolbar, click  **Global** and choose **Chain Drive**.

2 In the **Settings** window for **Chain Drive**, locate the **Chain Settings** section.

3 From the **Link type** list, choose **Elastic**.

4 Locate the **Joint Settings** section. From the **Attachment type** list, choose **Flexible**.

5 Click the **Create Links and Joints** button in the window toolbar.

##### *Hinge Joint: Sprocket: 1 (cdr1)*

In the **Model Builder** window, expand the **Component 1 (comp1) >**

**Multibody Dynamics (mbd) > cdr1: Sprocket** node, then click **Hinge Joint: Sprocket: 1 (cdr1)**.

##### *Prescribed Motion 1*

1 In the **Physics** toolbar, click  **Attributes** and choose **Prescribed Motion**.

2 In the **Settings** window for **Prescribed Motion**, locate the **Prescribed Rotational Motion** section.

3 From the **Prescribed motion through** list, choose **Angular velocity**.

4 In the  $\omega_p$  text field, type  $\text{omega}*\text{step1}(t)$ .

*Hinge Joint: Sprocket: 2 (cdr1)*

In the **Model Builder** window, under **Component 1 (comp1) > Multibody Dynamics (mbd) > cdr1: Sprocket** click **Hinge Joint: Sprocket: 2 (cdr1)**.

*Applied Force and Moment 1*

- 1 In the **Physics** toolbar, click  **Attributes** and choose **Applied Force and Moment**.
- 2 In the **Settings** window for **Applied Force and Moment**, locate the **Applied On** section.
- 3 From the list, choose **Joint**.
- 4 Locate the **Applied Force and Moment** section. In the  $M$  text field, type  $-T\_ext * step2(t)$ .

*Contact: Sprocket-Roller (cdr1)*

- 1 In the **Model Builder** window, expand the **Component 1 (comp1) > Multibody Dynamics (mbd) > cdr1: Contact** node, then click **Contact: Sprocket-Roller (cdr1)**.
- 2 In the **Settings** window for **Contact**, locate the **Contact Pressure Penalty Factor** section.
- 3 From the **Penalty factor control** list, choose **User defined**.
- 4 In the  $p_n$  text field, type  $pc$ .

## DEFINITIONS

*Variables 1*

- 1 In the **Model Builder** window, under **Component 1 (comp1)** right-click **Definitions** and choose **Variables**.
- 2 In the **Settings** window for **Variables**, locate the **Variables** section.
- 3 In the table, enter the following settings:

Name	Expression	Unit	Description
Flj_32	$\sqrt{mbd.cdr1hgj32.Fx^2 + mbd.cdr1hgj32.Fy^2}$	N	Link joint force, joint 32
Flj_8	$\sqrt{mbd.cdr1hgj8.Fx^2 + mbd.cdr1hgj8.Fy^2}$	N	Link joint force, joint 8
Flj_1	$\sqrt{mbd.cdr1hgj1.Fx^2 + mbd.cdr1hgj1.Fy^2}$	N	Link joint force, joint 1
Flj_33	$\sqrt{mbd.cdr1hgj33.Fx^2 + mbd.cdr1hgj33.Fy^2}$	N	Link joint force, joint 33

## MESH 1

### *Swept 1*

- 1 In the **Model Builder** window, expand the **Component 1 (comp1) > Mesh 1** node.
- 2 Right-click **Mesh 1** and choose **Swept**.

### *Size*

- 1 In the **Settings** window for **Size**, locate the **Element Size** section.
- 2 From the **Predefined** list, choose **Finer**.

### *Swept 1*



- 1 In the **Model Builder** window, click **Swept 1**.
- 2 In the **Settings** window for **Swept**, locate the **Mesh Generation** section.
- 3 From the **Elements** list, choose **Prisms**.
- 4 Click  **Build All**.

## STUDY 1

### *Step 1: Time Dependent*

- 1 In the **Model Builder** window, under **Study 1** click **Step 1: Time Dependent**.
- 2 In the **Settings** window for **Time Dependent**, locate the **Study Settings** section.
- 3 In the **Output times** text field, type range (0, 1e-3, 0.1).

### *Solution 1 (sol1)*

- 1 In the **Study** toolbar, click  **Show Default Solver**.
- 2 In the **Model Builder** window, expand the **Solution 1 (sol1)** node, then click **Time-Dependent Solver 1**.
- 3 In the **Settings** window for **Time-Dependent Solver**, click to expand the **Time Stepping** section.
- 4 From the **Steps taken by solver** list, choose **Intermediate**.
- 5 In the **Model Builder** window, expand the **Study 1 > Solver Configurations > Solution 1 (sol1) > Time-Dependent Solver 1** node, then click **Fully Coupled 1**.
- 6 In the **Settings** window for **Fully Coupled**, click to expand the **Method and Termination** section.
- 7 In the **Maximum number of iterations** text field, type 5.
- 8 In the **Study** toolbar, click  **Compute**.

## RESULTS

### *Displacement (mbd)*

Follow the instructions below to plot von Mises stress distribution similar to the one shown in [Figure 8](#).

- 1 Click the  **Show Grid** button in the **Graphics** toolbar.

### *von Mises Stress, All*

- 1 Right-click **Displacement (mbd)** and choose **Duplicate**.
- 2 In the **Settings** window for **3D Plot Group**, type von Mises Stress, All in the **Label** text field.

### *Surface*

- 1 In the **Model Builder** window, expand the **von Mises Stress, All** node, then click **Surface**.
- 2 In the **Settings** window for **Surface**, locate the **Expression** section.
- 3 In the **Expression** text field, type `mbd.mises`.
- 4 Click to expand the **Range** section. Select the **Manual color range** checkbox.
- 5 In the **Minimum** text field, type 0.
- 6 In the **Maximum** text field, type `1e5`.

Follow the instructions below to plot von Mises stress distribution in sprockets as shown in [Figure 9](#).

### *von Mises Stress, Sprockets*

- 1 In the **Model Builder** window, right-click **von Mises Stress, All** and choose **Duplicate**.
- 2 In the **Settings** window for **3D Plot Group**, type von Mises Stress, Sprockets in the **Label** text field.
- 3 Click to expand the **Selection** section. From the **Geometric entity level** list, choose **Domain**.
- 4 From the **Selection** list, choose **Sprockets (Roller Chain Sprocket 1)**.
- 5 Locate the **Plot Settings** section. From the **View** list, choose **New view**.



### *Surface*

- 1 In the **Model Builder** window, expand the **von Mises Stress, Sprockets** node, then click **Surface**.
- 2 In the **Settings** window for **Surface**, locate the **Range** section.
- 3 In the **Maximum** text field, type `2e4`.

### *Contour 1*

- 1 In the **Model Builder** window, right-click **von Mises Stress, Sprockets** and choose **Contour**.
- 2 In the **Settings** window for **Contour**, locate the **Expression** section.
- 3 In the **Expression** text field, type `mbd.mises`.
- 4 Click to expand the **Title** section. From the **Title type** list, choose **None**.
- 5 Locate the **Coloring and Style** section. From the **Coloring** list, choose **Uniform**.
- 6 From the **Color** list, choose **White**.
- 7 Locate the **Levels** section. In the **Total levels** text field, type 10.
- 8 Locate the **Coloring and Style** section. Clear the **Color legend** checkbox.

### *Deformation 1*

- 1 Right-click **Contour 1** and choose **Deformation**.
- 2 In the **Settings** window for **Deformation**, locate the **Scale** section.
- 3 Select the **Scale factor** checkbox. In the associated text field, type 1.
- 4 In the **von Mises Stress, Sprockets** toolbar, click  **Plot**.
- 5 Click the  **Go to XY View** button in the **Graphics** toolbar.
- 6 Click the  **Show Grid** button in the **Graphics** toolbar.



Follow the instructions below to plot von Mises stress distribution in two selected links as shown in [Figure 10](#).

### *von Mises Stress, Links*

- 1 In the **Model Builder** window, right-click **von Mises Stress, Sprockets** and choose **Duplicate**.
- 2 In the **Settings** window for **3D Plot Group**, type von Mises Stress, Links in the **Label** text field.
- 3 Locate the **Selection** section. Click  **Clear Selection**.
- 4 Select Domains 411–413, 417–421, and 439–454 only.
- 5 Select the **Apply to dataset edges** checkbox.
- 6 Locate the **Plot Settings** section. From the **View** list, choose **New view**.

### *Surface*

- 1 In the **Model Builder** window, expand the **von Mises Stress, Links** node, then click **Surface**.
- 2 In the **Settings** window for **Surface**, locate the **Range** section.
- 3 Clear the **Manual color range** checkbox.
- 4 In the **von Mises Stress, Links** toolbar, click  **Plot**.

- 5 Click the  **Go to Default View** button in the **Graphics** toolbar.
- 6 Click the  **Zoom Extents** button in the **Graphics** toolbar.

Follow the instructions below to plot joint forces in four selected links in the chain as shown in [Figure 11](#).



#### *Contact Pressure, Sprocket-1*

- 1 In the **Model Builder** window, right-click **Displacement (mbd)** and choose **Duplicate**.
- 2 In the **Settings** window for **3D Plot Group**, type Contact Pressure, Sprocket-1 in the **Label** text field.
- 3 Locate the **Selection** section. From the **Geometric entity level** list, choose **Domain**.
- 4 Locate the **Plot Settings** section. From the **View** list, choose **New view**.
- 5 Locate the **Selection** section. From the **Selection** list, choose **First Sprocket (Roller Chain Sprocket 1)**.
- 6 Select the **Apply to dataset edges** checkbox.

#### *Surface*

- 1 In the **Model Builder** window, expand the **Contact Pressure, Sprocket-1** node, then click **Surface**.
- 2 In the **Settings** window for **Surface**, locate the **Expression** section.
- 3 In the **Expression** text field, type  $mbd.Tn$ .

#### *Filter 1*

- 1 Right-click **Surface** and choose **Filter**.
- 2 In the **Settings** window for **Filter**, locate the **Element Selection** section.
- 3 In the **Logical expression for inclusion** text field, type  $mbd.Tn > 0$ .
- 4 In the **Contact Pressure, Sprocket-1** toolbar, click  **Plot**.
- 5 Click the  **Zoom Extents** button in the **Graphics** toolbar.

#### *Link Joint Forces*

- 1 In the **Results** toolbar, click  **ID Plot Group**.
- 2 In the **Settings** window for **ID Plot Group**, type Link Joint Forces in the **Label** text field.
- 3 Click to expand the **Title** section. From the **Title type** list, choose **Manual**.
- 4 In the **Title** text area, type Link Joint Force, Magnitude.
- 5 Locate the **Plot Settings** section.
- 6 Select the **y-axis label** checkbox. In the associated text field, type Force (N).

7 Locate the **Legend** section. From the **Position** list, choose **Upper left**.

#### *Global 1*

- 1 Right-click **Link Joint Forces** and choose **Global**.
- 2 In the **Settings** window for **Global**, locate the **y-Axis Data** section.
- 3 In the table, enter the following settings:

Expression	Unit	Description
Flj_32	N	Link joint force, joint 32
Flj_8	N	Link joint force, joint 8
Flj_1	N	Link joint force, joint 1
Flj_33	N	Link joint force, joint 33

- 4 In the **Link Joint Forces** toolbar, click  **Plot**.

#### *Displacement*

- 1 In the **Results** toolbar, click  **Animation** and choose **Player**.
- 2 In the **Settings** window for **Animation**, type Displacement in the **Label** text field.
- 3 Locate the **Frames** section. In the **Number of frames** text field, type 50.

#### *von Mises Stress, All*

- 1 Right-click **Displacement** and choose **Duplicate**.
- 2 In the **Settings** window for **Animation**, type von Mises Stress, All in the **Label** text field.
- 3 Locate the **Scene** section. From the **Subject** list, choose **von Mises Stress, All**.

#### *von Mises Stress, Sprockets*

- 1 Right-click **von Mises Stress, All** and choose **Duplicate**.
- 2 In the **Settings** window for **Animation**, type von Mises Stress, Sprockets in the **Label** text field.
- 3 Locate the **Scene** section. From the **Subject** list, choose **von Mises Stress, Sprockets**.

#### *von Mises Stress, Links*

- 1 Right-click **von Mises Stress, Sprockets** and choose **Duplicate**.
- 2 In the **Settings** window for **Animation**, type von Mises Stress, Links in the **Label** text field.
- 3 Locate the **Scene** section. From the **Subject** list, choose **von Mises Stress, Links**.

*Contact Pressure, Sprocket-1*

- 1** Right-click **von Mises Stress, Links** and choose **Duplicate**.
- 2** In the **Settings** window for **Animation**, type Contact Pressure, Sprocket -1 in the **Label** text field.
- 3** Locate the **Scene** section. From the **Subject** list, choose **Contact Pressure, Sprocket-1**.