



Model created in COMSOL Multiphysics 6.4

Optimization of a Crane Link Mechanism

Introduction

In complex mechanical systems, it can be challenging to find an optimal (or even good enough) solution only through engineering insight or trial-and-error procedures. Using mathematical optimization methods can then be an efficient path to a better design.

In this example, a link mechanism in a crane modeled in the Multibody Dynamics Module is optimized using the Optimization Module. The target is to reduce the cylinder force needed to carry a certain payload in a worst case operating cycle.

This example is a continuation of the model [Truck Mounted Crane](#).

Note: This model requires the Multibody Dynamics Module and the Optimization Module.

Model Definition

The complete crane geometry is shown in [Figure 1](#).

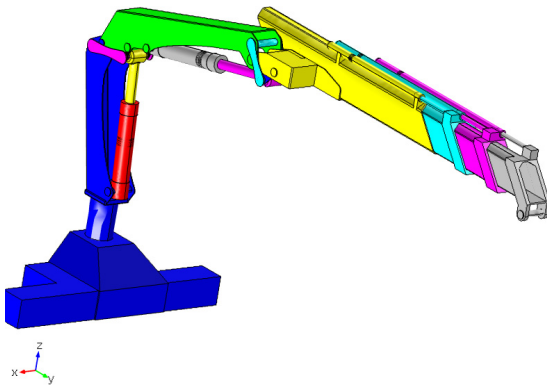

Figure 1: Crane geometry.

A close-up of the link mechanism used for controlling the inner boom is shown in [Figure 2](#). For more details about the crane model, please refer to the description of the model [Truck Mounted Crane](#).

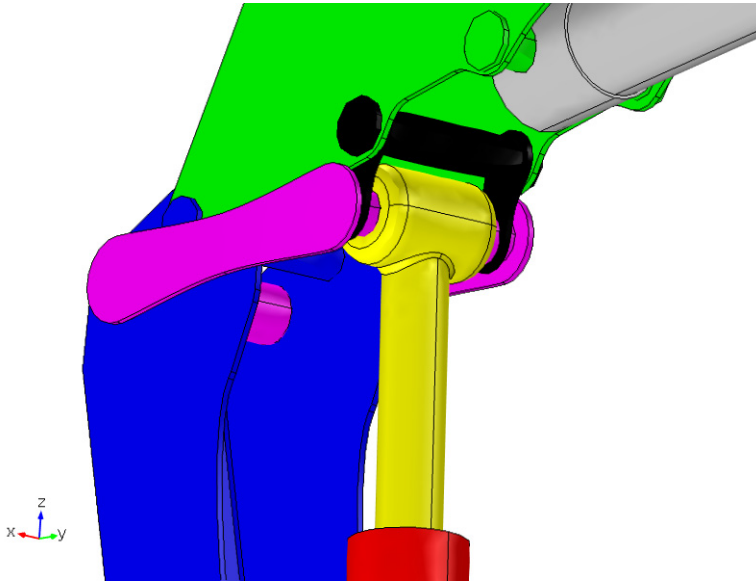

Figure 2: Close-up of link mechanisms.

A key to the coloring of the parts constituting the link mechanism is given in [Table 1](#).

TABLE 1: IDENTIFICATION OF CRANE PARTS IN LINK MECHANISM

Part	Name in model	Color in figure
Base	Base	Blue
Inner boom	Boom I	Green
Boom lift cylinder	Cylinder I	Red
Boom lift piston	Piston I	Yellow
Link mechanism	Link I, Link2	Magenta, Black

OPERATING CYCLE

The operating cycle is selected so that the moment carried by the link mechanism is as large as possible.

- The inner boom is raised from its lowest position, 45° downward slope, to its highest position (vertical) in steps of 15° .

- The telescopic extensions are as far out as possible in all positions.
- The angle of the outer boom is chosen so that the crane tip (and thus the payload) is as far out as possible.

LOADS

- Self-weight in the negative Z direction.
- A payload of 1000 kg at the tip of the crane.

OPTIMIZATION PROBLEM

The positions of three axles can be modified, as indicated in [Figure 3](#):

- The axle connecting the first link arm to the base.
- The axle connecting the second link arm to the boom.
- The axle connecting the two link arms and the piston of the hydraulic cylinder.

It is also necessary to ensure that the two latter axles do not move more than 10 mm closer to each other than they are in the original configuration to avoid mechanical interference.

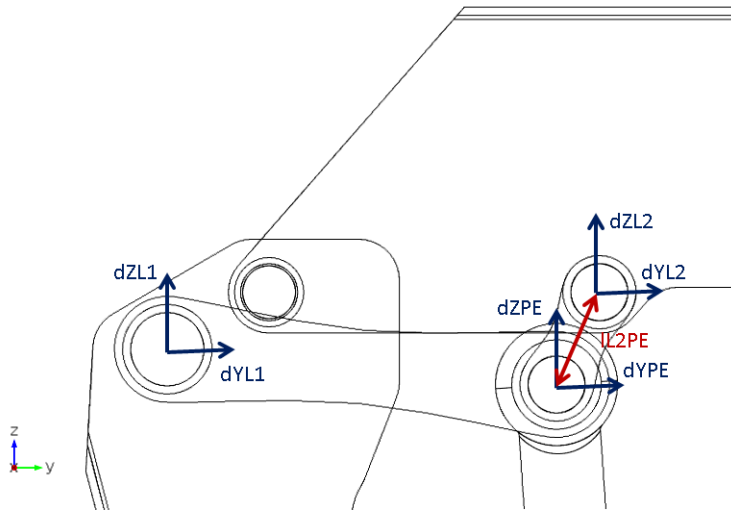

Figure 3: The optimization variables (blue) and the constraint (red).

The limits of the shifts on the axle positions are given in [Table 2](#).

TABLE 2: ALLOWED SHIFTS IN AXLE POSITIONS

Axle	Horizontal [mm]	Vertical [mm]
Base-Link1	dYL1 = [-100, +50]	dZL1 = [-150 - +30]
Boom1-Link1	dYL2 = [-50, +50]	dZL2= [-50, +100]
Link1-Link2-Piston1	dYPE = [-50, +120]	dZPE = [-100, +20]

Results and Discussion

The force in the cylinders controlling the boom are shown in [Figure 4](#). With the new design, it is possible to decrease the force by 31%, from 597 kN to 413 kN. This is a substantial improvement, and depending on the actual purpose of the analysis it can be utilized in two ways:

- The allowed payload can be increased. Since a significant fraction of the crane capacity is used for supporting its own weight, the increase in payload is more than 31%.
- For a constant payload, the reduced forces in the link mechanics does make it easier to reach stress and fatigue criteria for the link mechanism.

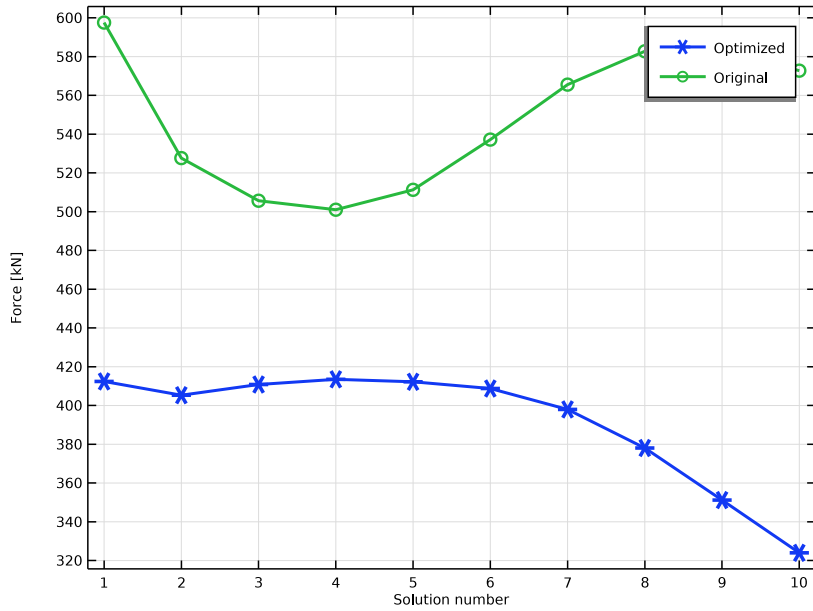

Figure 4: Variation of the cylinder force during the load cycle.

As an example of the effect of the optimization on other parts, the forces on the axle forming the hinge between the base and the boom is shown in [Figure 5](#).

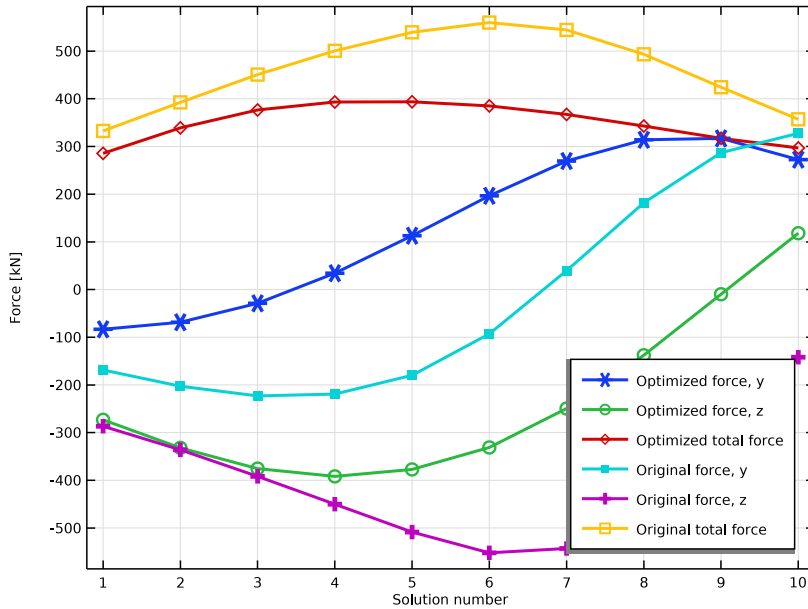

Figure 5: The forces acting on the axle between the base and the boom.

The actual values of the control variables in the optimized state may not be the same when this model is solved on different computers. The reason is that the minimum for the cylinder force can be obtained in different ways. There are multiple solutions which (within a small tolerance) give the same optimal values.

Notes About the COMSOL Implementation

Since all crane parts are rigid bodies, it is not necessary to actually move or deform the links during the optimization. It is sufficient to change the centers of the joints which mathematically represent the axles. This, however, leads to a nonintuitive graphic representation, as the links no longer rotate around the axles in the geometry.

The cylinder and piston are rotated physically in the model, since the direction of the cylinder force must be correct. Visually, the piston may look as if it was pulled out of the cylinder. This is also a graphical artifact, since another cylinder would be chosen if the modified geometry were to be selected for the final design.

In the optimization, the BOBYQA method is used. A gradient free method is suitable, since it is not possible to compute derivatives of the maximum cylinder forces with respect to the optimization parameters.

Application Library path: Multibody_Dynamics_Module/
Machinery_and_Robotics/crane_link_optimization

Modeling Instructions

APPLICATION LIBRARIES

- 1 From the **File** menu, choose **Application Libraries**.
- 2 In the **Application Libraries** window, select **Multibody Dynamics Module > Machinery and Robotics > truck_mounted_crane** in the tree.
- 3 Click  **Open**.

ROOT

Add the parameters needed for parameterizing the link.

GLOBAL DEFINITIONS

Parameters 1

- 1 In the **Model Builder** window, under **Global Definitions** click **Parameters 1**.
- 2 In the **Settings** window for **Parameters**, locate the **Parameters** section.
- 3 Click  **Load from File**.
- 4 Browse to the model's Application Libraries folder and double-click the file `crane_link_optimization_parameters.txt`.

COMPONENT 1 (COMP1)

The cylinder and the piston must have the correct direction in order to get the correct cylinder force.

GEOMETRY 1

Rotate 1 (rot1)

- 1 In the **Model Builder** window, expand the **Component 1 (comp1)** node.
- 2 Right-click **Component 1 (comp1) > Geometry 1** and choose **Transforms > Rotate**.

- 3 Select the objects **impl(31)** and **impl(32)** only.
- 4 In the **Settings** window for **Rotate**, locate the **Point on Axis of Rotation** section.
- 5 In the **y** text field, type YCE.
- 6 In the **z** text field, type ZCE.
- 7 Locate the **Rotation** section. In the **Angle** text field, type cylRot.
- 8 From the **Axis type** list, choose **x-axis**.

MULTIBODY DYNAMICS (MBD)

In the **Model Builder** window, expand the **Component 1 (comp1)** > **Multibody Dynamics (mbd)** node.

Hinge Joints

In the **Model Builder** window, expand the **Component 1 (comp1)** > **Multibody Dynamics (mbd)** > **Hinge Joints** node.

Hinge Base-Link 1

Parameterize the joint centers for the adjustable joints.

- 1 In the **Model Builder** window, expand the **Component 1 (comp1)** > **Multibody Dynamics (mbd)** > **Hinge Joints** > **Hinge Base-Link1** node, then click **Hinge Base-Link1**.
- 2 In the **Settings** window for **Hinge Joint**, locate the **Center of Joint** section.
- 3 From the list, choose **User defined**.
- 4 Specify the \mathbf{X}_c vector as

XC	x
mYL1	y
mZL1	z

Hinge Boom1-Link2

- 1 In the **Model Builder** window, click **Hinge Boom1-Link2**.
- 2 In the **Settings** window for **Hinge Joint**, locate the **Center of Joint** section.
- 3 From the list, choose **User defined**.
- 4 Specify the \mathbf{X}_c vector as

XC	x
----	---

mYL2	y
mZL2	z

Slot Link I-Link2

- 1 In the **Model Builder** window, expand the **Component 1 (comp1)** > **Multibody Dynamics (mbd)** > **Slot Joints** node, then click **Slot Link1-Link2**.
- 2 In the **Settings** window for **Slot Joint**, locate the **Center of Joint** section.
- 3 From the list, choose **User defined**.
- 4 Specify the \mathbf{X}_c vector as

XC	x
mYPE	y
mZPE	z

Slot Link I-Piston I

- 1 In the **Model Builder** window, click **Slot Link1-Piston I**.
- 2 In the **Settings** window for **Slot Joint**, locate the **Center of Joint** section.
- 3 From the list, choose **User defined**.
- 4 Specify the \mathbf{X}_c vector as

XC	x
mYPE	y
mZPE	z

GLOBAL DEFINITIONS

Parameters I

- 1 In the **Model Builder** window, under **Global Definitions** click **Parameters I**.
- 2 In the **Settings** window for **Parameters**, locate the **Parameters** section.
- 3 In the table, enter the following settings:

Name	Expression	Value	Description
ExtLen	5.5[m]	5.5 m	Total extension length

STUDY I

Change the load cycle to a worst case scenario and compute.

Step 1: Stationary

- 1 In the **Model Builder** window, expand the **Study 1** node, then click **Step 1: Stationary**.
- 2 In the **Settings** window for **Stationary**, locate the **Study Extensions** section.
- 3 In the table, enter the following settings:

Parameter name	Parameter value list	Parameter unit
Angle1 (Angle to horizontal, inner boom)	range (-45, 15, 90)	rad
RelAng (Angle between booms)	0 0 0 range (0, -15, -90)	rad

- 4 Click to select row number 3 in the table.
- 5 Click  **Delete**.
- 6 In the **Model Builder** window, expand the **Study 1** node.

Solver Configurations

In the **Model Builder** window, expand the **Study 1 > Solver Configurations** node.

Solution 1 (sol1)

- 1 In the **Model Builder** window, expand the **Study 1 > Solver Configurations > Solution 1 (sol1) > Dependent Variables 1** node, then click **comp1.mbd_rd_rot**.
- 2 In the **Settings** window for **State**, locate the **Scaling** section.
- 3 In the **Scale** text field, type 0.5.
- 4 In the **Model Builder** window, click **comp1.mbd_jnt_rot**.
- 5 In the **Settings** window for **State**, locate the **Scaling** section.
- 6 In the **Scale** text field, type 0.5.
- 7 In the **Model Builder** window, click **Global Equations 1 (comp1.ODE1)**.
- 8 In the **Settings** window for **State**, locate the **Scaling** section.
- 9 In the **Scale** text field, type 0.5.
- 10 In the **Model Builder** window, click **Study 1**.
- 11 In the **Settings** window for **Study**, type Study 1: Initial Design in the **Label** text field.
- 12 In the **Study** toolbar, click  **Compute**.

RESULTS

Extension Cylinder Forces

In the **Model Builder** window, under **Results** right-click **Extension Cylinder Forces** and choose **Delete**.

Global 1

- 1 In the **Model Builder** window, expand the **Results > Hinge Forces** node, then click **Global 1**.
- 2 In the **Settings** window for **Global**, locate the **y-Axis Data** section.
- 3 Click to select row number 3 in the table.
- 4 Click  **Delete** twice.
- 5 In the table, enter the following settings:



Expression	Unit	Description
mbd.hgj1.Fy	kN	Optimized force, y
mbd.hgj1.Fz	kN	Optimized force, z
$\sqrt{\text{mbd.hgj1.Fy}^2 + \text{mbd.hgj1.Fz}^2}$	kN	Optimized total force

Global 2

- 1 Right-click **Results > Hinge Forces > Global 1** and choose **Duplicate**.
- 2 In the **Settings** window for **Global**, locate the **Data** section.
- 3 From the **Dataset** list, choose **Study 1: Initial Design/Solution 1 (sol1)**.
- 4 Locate the **y-Axis Data** section. In the table, enter the following settings:

Expression	Unit	Description
mbd.hgj1.Fy	kN	Original force, y
mbd.hgj1.Fz	kN	Original force, z
$\sqrt{\text{mbd.hgj1.Fy}^2 + \text{mbd.hgj1.Fz}^2}$	kN	Original total force

ADD STUDY

- 1 In the **Home** toolbar, click  **Windows** and choose **Add Study**.
- 2 Go to the **Add Study** window.
- 3 Find the **Studies** subsection. In the **Select Study** tree, select **Empty Study**.
- 4 Click the **Add Study** button in the window toolbar.
- 5 In the **Home** toolbar, click  **Add Study** to close the **Add Study** window.

STUDY 1: INITIAL DESIGN

Step 1: Stationary

In the **Model Builder** window, under **Study 1: Initial Design** right-click **Step 1: Stationary** and choose **Copy**.

STUDY 2

In the **Model Builder** window, right-click **Study 2** and choose **Paste Stationary**.

Add the optimization study.

Parameter Optimization

- 1 In the **Study** toolbar, click  **Optimization** and choose **Parameter Optimization**.
- 2 In the **Settings** window for **Parameter Optimization**, locate the **Optimization Solver** section.
- 3 In the **Optimality tolerance** text field, type 0.1.
Avoid that the optimization loop stops in the case that a state cannot be solved.
- 4 Click to expand the **Solver Settings** section. Clear the **Stop if error** checkbox.
- 5 Find the **Objective settings** subsection. From the **Objective scaling** list, choose **None**.
- 6 Locate the **Objective Function** section. In the table, enter the following settings:

Expression	Description	Evaluate for
abs(comp1.mbd.prj1.F11)	Cylinder force (inner)	Stationary

- 7 From the **Solution** list, choose **Maximum of objectives**.
- 8 Locate the **Control Parameters** section. Click  **Load from File**.
- 9 Browse to the model's Application Libraries folder and double-click the file crane_link_optimization_ctrlvars.txt.
- 10 Locate the **Constraints** section. In the table, enter the following settings:

Expression	Lower bound	Upper bound	Evaluate for
mdL2PE-dL2PE	-0.01		Stationary

- 11 Click to expand the **Output** section. Select the **Plot** checkbox.

- 12 In the table, enter the following settings:

Plot group	Plot window
Boom Cylinder Forces	Graphics

- 13 In the **Model Builder** window, click **Study 2**.
- 14 In the **Settings** window for **Study**, type Study 2: Optimization in the **Label** text field.
- 15 Locate the **Study Settings** section. Clear the **Generate default plots** checkbox.
- 16 In the **Study** toolbar, click  **Get Initial Value**.

Solver Configurations

In the **Model Builder** window, expand the **Study 2: Optimization > Solver Configurations** node.

Solution 2 (sol2)

- 1 In the **Model Builder** window, expand the **Study 2: Optimization > Solver Configurations > Solution 2 (sol2) > Dependent Variables 1** node, then click **Rigid Material Rotations (comp1.mbd_rd_rot)**.
- 2 In the **Settings** window for **State**, locate the **Scaling** section.
- 3 In the **Scale** text field, type 0.5.
- 4 In the **Model Builder** window, click **Joint Rotations (comp1.mbd_jnt_rot)**.
- 5 In the **Settings** window for **State**, locate the **Scaling** section.
- 6 In the **Scale** text field, type 0.5.
- 7 In the **Model Builder** window, click **Global Equations 1 (comp1.ODE1)**.
- 8 In the **Settings** window for **State**, locate the **Scaling** section.
- 9 From the **Method** list, choose **Manual**.
- 10 In the **Scale** text field, type 0.5.

RESULTS

Boom Cylinder Forces

- 1 In the **Model Builder** window, under **Results** click **Boom Cylinder Forces**.
- 2 In the **Settings** window for **ID Plot Group**, locate the **Data** section.
- 3 From the **Dataset** list, choose **Study 2: Optimization/Solution 2 (sol2)**.

Hinge Forces

- 1 In the **Model Builder** window, click **Hinge Forces**.
- 2 In the **Settings** window for **ID Plot Group**, locate the **Data** section.
- 3 From the **Dataset** list, choose **Study 2: Optimization/Solution 2 (sol2)**.

Global 1

- 1 In the **Model Builder** window, expand the **Results > Boom Cylinder Forces** node, then click **Global 1**.
- 2 In the **Settings** window for **Global**, locate the **y-Axis Data** section.
- 3 Click to select row number 2 in the table.
- 4 Click  **Delete**.
- 5 In the table, enter the following settings:

Expression	Unit	Description
abs(comp1.mbd.prj1.F11)	kN	Optimized

Global 2

- 1 Right-click **Results > Boom Cylinder Forces > Global 1** and choose **Duplicate**.
- 2 In the **Settings** window for **Global**, locate the **Data** section.
- 3 From the **Dataset** list, choose **Study 1: Initial Design/Solution 1 (sol1)**.
- 4 Locate the **y-Axis Data** section. In the table, enter the following settings:

Expression	Unit	Description
abs(comp1.mbd.prj1.F11)	kN	Original



STUDY 2: OPTIMIZATION

In the **Study** toolbar, click  **Compute**.



Run the optimization.

RESULTS

Boom Cylinder Forces

- 1 Click the  **Zoom Extents** button in the **Graphics** toolbar.
- 2 In the **Boom Cylinder Forces** toolbar, click  **Plot**.

Hinge Forces

- 1 Click the  **Zoom Extents** button in the **Graphics** toolbar.
- 2 In the **Model Builder** window, click **Hinge Forces**.
- 3 In the **Hinge Forces** toolbar, click  **Plot**.