



Model created in COMSOL Multiphysics 6.4

Component Mode Synthesis Tutorial

Introduction

In this tutorial model, the concepts of Component Mode Synthesis (CMS) are introduced through a simple solid model of a cantilever beam. Parts of the beam are reduced by the CMS technique. It is, furthermore, shown how CMS can be used to represent both the static and dynamic behavior of the entire assembly by studying the damped free vibration of the beam. The example, moreover, explores two different ways of applying loads on reduced components.

To verify the validity of the model reduced by CMS, its results are compared to those from a full (unreduced) version of the model.

Model Definition

The model consists of a 3 m long cantilever beam with a rectangular cross section of dimension 0.15-by-0.2 m. In order to show the CMS reduction technique, the beam is split into three 1 m long parts, or components, as seen in [Figure 1](#). When working with CMS, disconnected components are connected using **Attachment** nodes combined with joints. In this example, they are rigidly connected using a **Fixed Joint**.

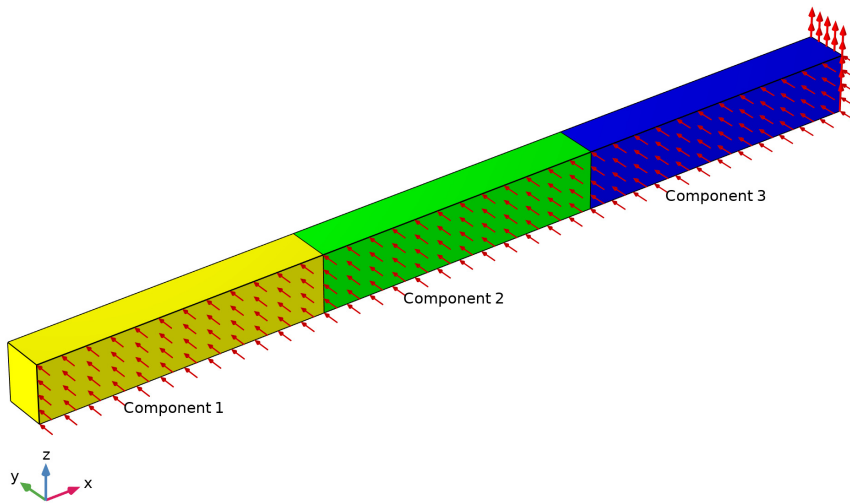

Figure 1: Geometry of the model showing three components and the applied loads.

All three components are considered to be elastic and have viscous damping with material properties according to [Table 1](#). The Young's modulus of component 2 is, however, made dependent on the axial strain ϵ_{xx} ; this nonlinearity means that it cannot be reduced by the CMS technique.

TABLE 1: MATERIAL PROPERTIES.

Property	Symbol	Unit	Value
Density	ρ	kg/m^3	7850
Young's modulus	E	GPa	200
Poisson's ratio	ν	1	0.3
Bulk viscosity	η_b	MPa·s	50
Shear viscosity	η_v	MPa·s	20

The analysis includes two study steps:

- 1 A stationary step to compute the loaded initial conditions
- 2 A time-dependent step to compute the damped free vibration of the beam

To define the boundary conditions, a fixed constraint is applied to the free end of component 1 and two distributed loads are applied to the beam, as can be seen in [Figure 1](#). The load in the y direction is given a magnitude of 0.1 MPa and is kept constant throughout both steps. The load in the z direction is applied to the free end of component 3 and is given a magnitude of 1 MPa, but it is only active during the stationary step. Hence, as the load is removed as the beam starts to vibrate.

Moreover, the analysis is run in two configurations:

- 1 All components are unreduced. This corresponds to the standard solution of the problem by the Finite Element Method (FEM).
- 2 Components 1 and 3 are reduced using CMS, while component 2 is unreduced. This corresponds to a hybrid CMS and FEM solution to the problem.

When working with CMS, the full static and dynamic behavior of a component is represented by a number of constrained eigenmodes, and static constraint modes. These are independent of each other and are used to construct a so-called reduced-order model (ROM) for each reduced component. In essence, the ROM consists of small stiffness and mass matrices, designed so that the static stiffness, inertial properties, and characteristic dynamic properties are maintained. The ROM can also contain other information, such as loads applied on the reduced component.

The number of eigenmodes must be sufficiently large so that the dynamics of the component can be represented accurately. In this example, six eigenmodes are used when reducing components 1 and 3. This is enough to describe the first four bending modes, one twisting mode, and one axial extension mode as shown in [Figure 2](#).

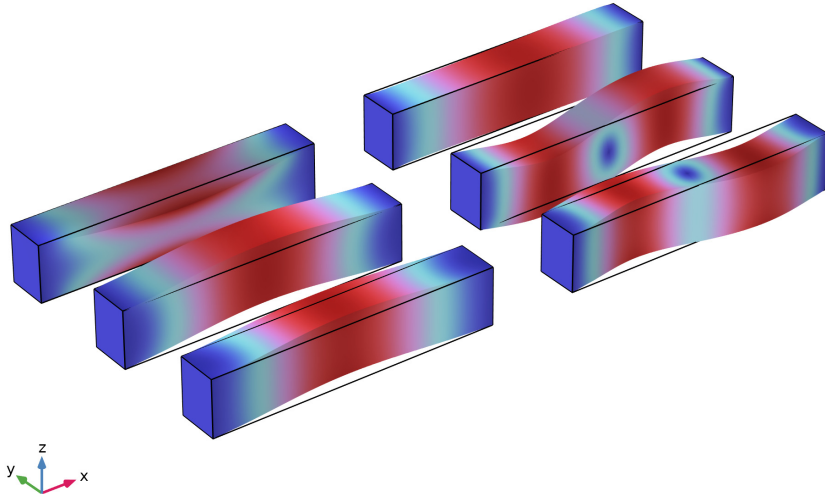

Figure 2: The six constrained eigenmodes.

The number of constraint modes depends on the connections to other parts of the model; in COMSOL Multiphysics, the number of **Attachment** nodes. In this example, component 1 has one such node to connect it to component 2. For component 3, two **Attachment** nodes are used, even though there is only one connection to another component. This exemplifies that an **Attachment** node does not have to be connected to other parts of the model, but can also be used to make it possible for the reduced component to represent additional static modes. Here the extra attachment is needed to

represent the static deformation caused by the two loads. A set of six constraint modes is shown in [Figure 3](#). This represents all modes related to one **Attachment** node.

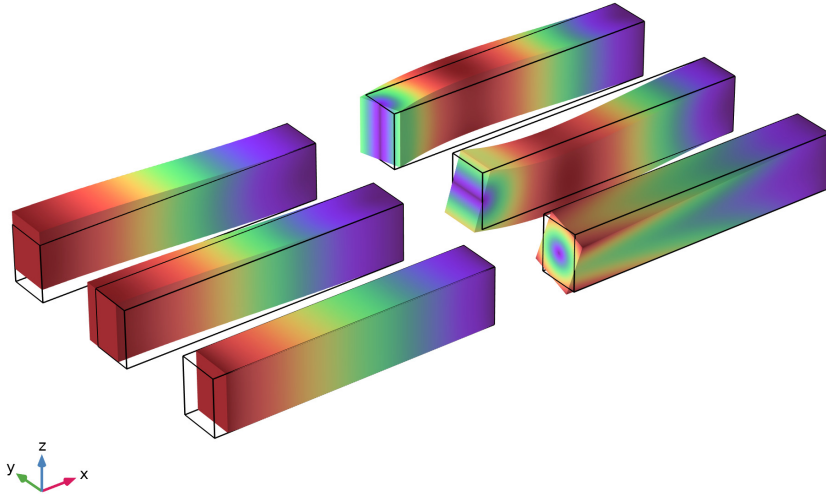

Figure 3: The six constraint modes for one of the Attachment nodes of component 3.

The constraint modes are generated by setting each attachment degree of freedom to 1 while the others are fixed. Thus, an attachment in 3D will give six constraint modes (three translations and three rotations). In 2D, there will be three constraint modes.

Results and Discussion

[Figure 4](#) shows the tip displacement of the cantilever beam during the time dependent step for both the full solution, and while using the CMS technique. The agreement is in general very good.

It is possible to visualize all result variables also in the reduced components. Hence, we can compare, for example, the von Mises stress in the two configurations. This is shown in [Figure 5](#) and [Figure 6](#), where the stress level in the beam at $t = 0$ is displayed for the full and reduced model, respectively. The stress level is practically identical for the two configurations. In the figures, the effect of connecting the components by attachments

and rigid connections is clearly visible as a disturbance in the stress field at the transition between components 1 and 2 for both configurations.

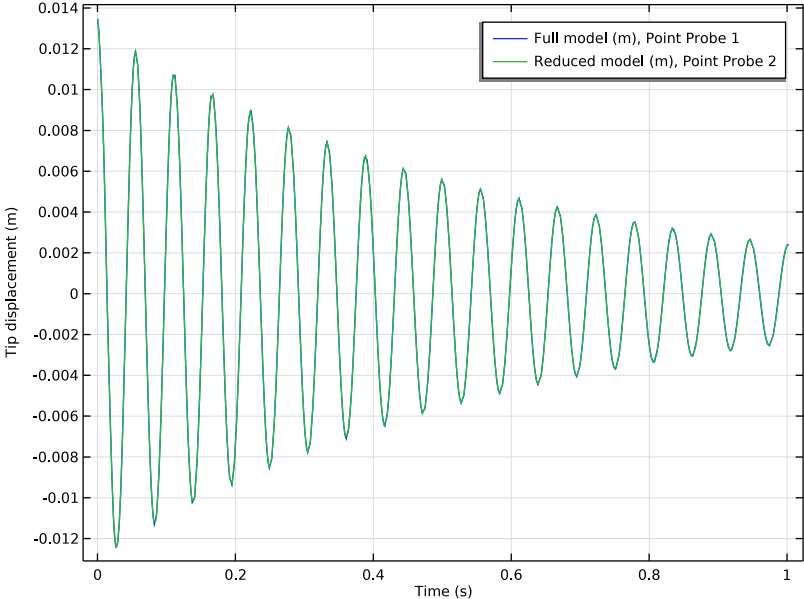

Figure 4: Tip displacement for both configurations of the analysis.

Time=0 s, load=0 MPa

von Mises stress (N/m²)

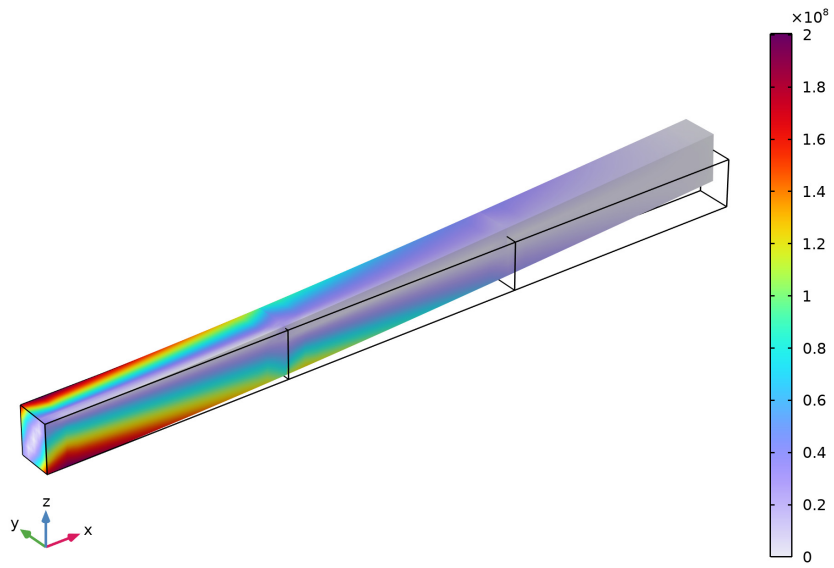

Figure 5: Distribution of the von Mises stress at $t = 0$ for the full (unreduced) model.

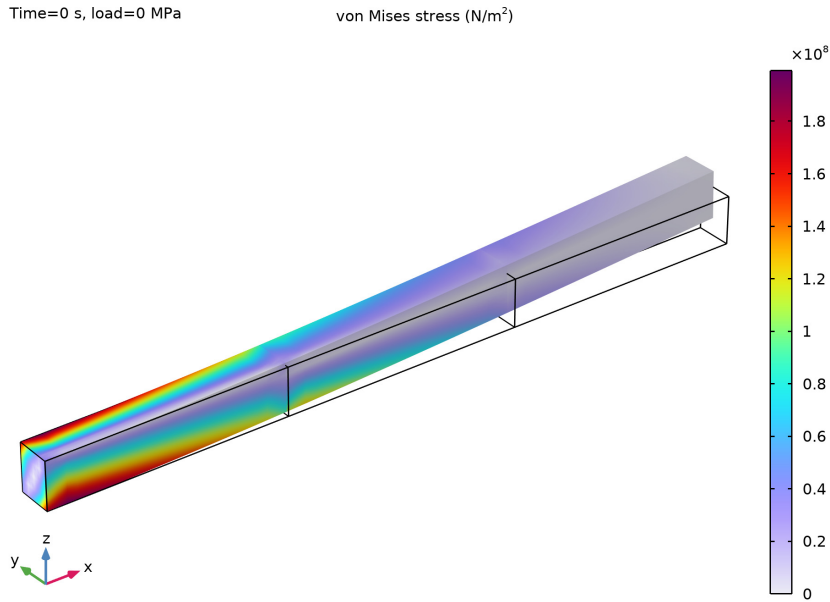

Figure 6: Distribution of the von Mises stress at $t = 0$ for the reduced model.

Notes About the COMSOL Implementation

When setting up the reduced model, the two boundary loads actually represent two different ways of applying loads to a reduced component:

- 1** The contribution of the load in the y direction is applied external to the ROM.
- 2** The contribution of the load in the z direction is internal to the ROM, and is parameterized by a control variable.

While possible, it is normally not best practice to mix these two methods in the same model. In this example, this is nevertheless done in order to showcase them both. In most cases, the first method is preferable as it provides more flexibility, but in some cases it can be more expensive when performing the global analysis.

For this small example, solving the full model is actually faster than the reduced model. This follows from the extra work related to the ROMs that represent the reduced

components. As the model size increases, the extra work related to the ROMs scales better than solving the full model, and one can expect improved performance when using CMS.

Application Library path: Multibody_Dynamics_Module/Tutorials/cms_tutorial



Modeling Instructions

From the **File** menu, choose **New**.

NEW

In the **New** window, click  **Model Wizard**.

MODEL WIZARD

- 1 In the **Model Wizard** window, click  **3D**.
- 2 In the **Select Physics** tree, select **Structural Mechanics > Solid Mechanics (solid)**.
- 3 Click **Add**.
- 4 Click  **Study**.
- 5 In the **Select Study** tree, select **General Studies > Stationary**.
- 6 Click  **Done**.

GEOMETRY I

Block 1 (blk1)

- 1 In the **Geometry** toolbar, click  **Block**.
- 2 In the **Settings** window for **Block**, locate the **Size and Shape** section.
- 3 In the **Depth** text field, type 0.15.
- 4 In the **Height** text field, type 0.2.

Array 1 (arr1)

- 1 In the **Geometry** toolbar, click  **Transforms** and choose **Array**.
- 2 Select the object **blk1** only.
- 3 In the **Settings** window for **Array**, locate the **Size** section.
- 4 In the **x size** text field, type 3.
- 5 Locate the **Displacement** section. In the **x** text field, type 1.

Form Union (fin)

Create an assembly so that selected parts can be reduced.

- 1 In the **Model Builder** window, under **Component 1 (comp1) > Geometry 1** click **Form Union (fin)**.
- 2 In the **Settings** window for **Form Union/Assembly**, locate the **Form Union/Assembly** section.
- 3 From the **Action** list, choose **Form an assembly**.
- 4 Clear the **Create pairs** checkbox.
- 5 In the **Geometry** toolbar, click  **Build All**.

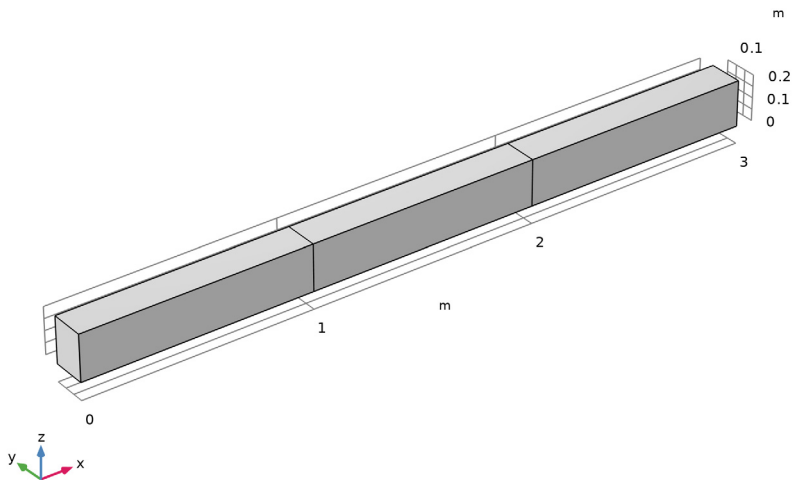

SOLID MECHANICS (SOLID)

Linear Elastic Material 1

In the **Model Builder** window, under **Component 1 (comp1) > Solid Mechanics (solid)** click **Linear Elastic Material 1**.

Damping 1

- 1 In the **Physics** toolbar, click  **Attributes** and choose **Damping**.
- 2 In the **Settings** window for **Damping**, locate the **Damping Settings** section.
- 3 From the **Damping type** list, choose **Viscous damping**.

4 In the η_b text field, type 5e7.

5 In the η_v text field, type 2e7.

Fixed Constraint 1

1 In the **Physics** toolbar, click  **Boundaries** and choose **Fixed Constraint**.

2 Select Boundary 1 only.

Connect the assembly parts with **Attachment** and **Fixed Joint** nodes. An **Attachment** is added to the free end with no constraints; this is only necessary when later building the reduced model in order to capture all deformation modes during model reduction.

Attachment 1

1 In the **Physics** toolbar, click  **Boundaries** and choose **Attachment**.

2 Select Boundary 6 only.

Attachment 2

1 Right-click **Attachment 1** and choose **Duplicate**.

2 Select Boundary 7 only.

Fixed Joint 1

1 In the **Physics** toolbar, click  **Global** and choose **Fixed Joint**.

2 In the **Settings** window for **Fixed Joint**, locate the **Attachment Selection** section.

3 From the **Source** list, choose **Attachment 1**.

4 From the **Destination** list, choose **Attachment 2**.

Attachment 3

1 In the **Physics** toolbar, click  **Boundaries** and choose **Attachment**.

2 Select Boundary 12 only.

Attachment 4

1 Right-click **Attachment 3** and choose **Duplicate**.

2 Select Boundary 13 only.

Fixed Joint 2

1 In the **Physics** toolbar, click  **Global** and choose **Fixed Joint**.

2 In the **Settings** window for **Fixed Joint**, locate the **Attachment Selection** section.

3 From the **Source** list, choose **Attachment 3**.

4 From the **Destination** list, choose **Attachment 4**.

Attachment 5

- 1 In the **Physics** toolbar, click  **Boundaries** and choose **Attachment**.
- 2 Select Boundary 18 only.

Apply a boundary load at the free end of the cantilever beam. The force per unit area in the z direction will be controlled by a parameter `load` in the study steps.

GLOBAL DEFINITIONS

Parameters 1

- 1 In the **Model Builder** window, under **Global Definitions** click **Parameters 1**.
- 2 In the **Settings** window for **Parameters**, locate the **Parameters** section.
- 3 In the table, enter the following settings:

Name	Expression	Value	Description
load	0[Pa]	0 Pa	Load parameter

SOLID MECHANICS (SOLID)

Boundary Load 1

- 1 In the **Physics** toolbar, click  **Boundaries** and choose **Boundary Load**.
- 2 Select Boundary 18 only.
- 3 In the **Settings** window for **Boundary Load**, locate the **Force** section.
- 4 Specify the \mathbf{f}_A vector as

0	x
0	y
load	z

Apply a constant boundary load on one of the sides of the beam.

Boundary Load 2

- 1 In the **Physics** toolbar, click  **Boundaries** and choose **Boundary Load**.
- 2 Select Boundaries 2, 8, and 14 only.
- 3 In the **Settings** window for **Boundary Load**, locate the **Force** section.
- 4 Specify the \mathbf{f}_A vector as

0	x
---	---

1e5	y
0	z

MATERIALS

Material, Linear

- 1 In the **Model Builder** window, under **Component 1 (comp1)** right-click **Materials** and choose **Blank Material**.
- 2 In the **Settings** window for **Material**, type **Material, Linear** in the **Label** text field.
- 3 Locate the **Material Contents** section. In the table, enter the following settings:

Property	Variable	Value	Unit	Property group
Young's modulus	E	200e9	Pa	Young's modulus and Poisson's ratio
Poisson's ratio	nu	0.3	l	Young's modulus and Poisson's ratio
Density	rho	7850	kg/m ³	Basic

Make the material of the middle part nonlinear by defining Young's modulus as a function of the axial strain.

Material, Linear 1 (mat2)

- 1 Right-click **Material, Linear** and choose **Duplicate**.
- 2 Select Domain 2 only.

DEFINITIONS

Step 1 (step1)

- 1 In the **Definitions** toolbar, click **f(x)** **More Functions** and choose **Step**.
- 2 In the **Settings** window for **Step**, locate the **Parameters** section.
- 3 In the **From** text field, type 0.8.
- 4 In the **To** text field, type 1.2.
- 5 Click to expand the **Smoothing** section. In the **Size of transition zone** text field, type 1e-3.

MATERIALS

Material, Nonlinear

- 1 In the **Model Builder** window, under **Component 1 (comp1) > Materials** click **Material, Linear 1 (mat2)**.
- 2 In the **Settings** window for **Material**, type **Material1, Nonlinear** in the **Label** text field.
- 3 Locate the **Material Contents** section. In the table, enter the following settings:

Property	Variable	Value	Unit	Property group
Young's modulus	E	200e9*step1(solid.eXX)	Pa	Young's modulus and Poisson's ratio

Create a structured mesh.

MESH 1

Mapped 1

- 1 In the **Mesh** toolbar, click  **More Generators** and choose **Mapped**.
- 2 Select **Boundaries 1, 7, and 13** only.

Distribution 1

- 1 Right-click **Mapped 1** and choose **Distribution**.
- 2 In the **Settings** window for **Distribution**, locate the **Edge Selection** section.
- 3 From the **Selection** list, choose **All edges**.
- 4 Locate the **Distribution** section. In the **Number of elements** text field, type **4**.

Swept 1

In the **Mesh** toolbar, click  **Swept**.

Distribution 1

- 1 Right-click **Swept 1** and choose **Distribution**.
- 2 In the **Settings** window for **Distribution**, locate the **Distribution** section.
- 3 In the **Number of elements** text field, type **12**.
- 4 Click  **Build All**.

The first study will be used to compute the full (unreduced) model of the beam. Add a **Time Dependent** study step to **Study 1**. Use the parameter **load** to apply a vertical load of 1

MPa at the free end during the stationary step. The load is then removed to study the damped free vibration of the beam.

STUDY, FULL MODEL

- 1 In the **Model Builder** window, click **Study 1**.
- 2 In the **Settings** window for **Study**, type Study, Full Model in the **Label** text field.

Step 2: Time Dependent

- 1 In the **Study** toolbar, click  **Time Dependent**.
- 2 In the **Settings** window for **Time Dependent**, locate the **Study Settings** section.
- 3 In the **Output times** text field, type range (0,0.05,1).

Step 1: Stationary

- 1 In the **Model Builder** window, click **Step 1: Stationary**.
- 2 In the **Settings** window for **Stationary**, click to expand the **Study Extensions** section.
- 3 Select the **Auxiliary sweep** checkbox.
- 4 Click **+ Add**.
- 5 In the table, enter the following settings:

Parameter name	Parameter value list	Parameter unit
load (Load parameter)	1	MPa

- 6 From the **Run continuation for** list, choose **No parameter**.

Step 2: Time Dependent



- 1 In the **Model Builder** window, click **Step 2: Time Dependent**.
- 2 In the **Settings** window for **Time Dependent**, click to expand the **Study Extensions** section.
- 3 Select the **Auxiliary sweep** checkbox.
- 4 Click **+ Add**.
- 5 In the table, enter the following settings:

Parameter name	Parameter value list	Parameter unit
load (Load parameter)	0	MPa

Create a **Point Probe** to monitor the vertical displacement of the free end.

DEFINITIONS

Point Probe 1 (point1)

- 1 In the **Definitions** toolbar, click  **Probes** and choose **Point Probe**.
- 2 In the **Settings** window for **Point Probe**, locate the **Source Selection** section.
- 3 Click  **Clear Selection**.
- 4 Select Point 21 only.
- 5 Locate the **Expression** section. In the **Expression** text field, type w .
- 6 Select the **Description** checkbox. In the associated text field, type Full model.

STUDY, FULL MODEL

Step 1: Stationary

- 1 In the **Model Builder** window, under **Study, Full Model** click **Step 1: Stationary**.
- 2 In the **Settings** window for **Stationary**, click to expand the **Results While Solving** section.
- 3 From the **Probes** list, choose **None**.
- 4 In the **Study** toolbar, click  **Compute**.

You will now use Component Mode Synthesis and model reduction to reduce the number of degrees of freedom of the two linear parts of the assembly. Any number of linear parts of the assembly can be reduced using a **Reduced Flexible Components** node. In this example, the middle part of the beam is nonlinear and cannot be reduced. Disconnected parts of the selection are automatically detected and identified as individual components.

SOLID MECHANICS (SOLID)

Reduced Flexible Components 1

- 1 In the **Physics** toolbar, click  **Domains** and choose **Reduced Flexible Components**.
- 2 Select Domains 1 and 3 only.

The load at the free end will in this tutorial be part of the ROM. To control its amplitude, add a control variable $load$ in a **Global Reduced Model Input** node; enable **Reduced-Order Modeling** in the **Show More Options** dialog to show it. Using the name of an existing model parameter will redefine that parameter as a reduced model input with value linked from the parameter's original definition.

- 3 Click the  **Show More Options** button in the **Model Builder** toolbar.
- 4 In the **Show More Options** dialog, select **Study > Reduced-Order Modeling** in the tree.
- 5 In the tree, select the checkbox for the node **Study > Reduced-Order Modeling**.

6 Click **OK**.

GLOBAL DEFINITIONS

Global Reduced-Model Inputs |

- 1 In the **Physics** toolbar, click  **Reduced-Order Modeling** and choose **Global Reduced-Model Inputs**.
- 2 In the **Settings** window for **Global Reduced-Model Inputs**, locate the **Reduced-Model Inputs** section.
- 3 In the table, enter the following settings:

Control name	Expression
load	0[Pa]

SOLID MECHANICS (SOLID)

Reduced Flexible Components |

You can automatically set up a study sequence for the model reduction of each component from the **Reduced Flexible Components** node. Use six eigenmodes for both components.

- 1 In the **Model Builder** window, under **Component 1 (comp1) > Solid Mechanics (solid)** click **Reduced Flexible Components 1**.
- 2 In the **Settings** window for **Reduced Flexible Components**, locate the **Component Mode Synthesis** section.
- 3 In the **Number of eigenmodes** text field, type 6.
- 4 Click **Automated Model Setup** in the upper-right corner of the **Component Mode Synthesis** section. From the menu, choose **Configure CMS Study**.

Boundary Load 1 should be part of the reduced component and needs to be enabled in the reference study step of the **Model Reduction** step.

CMS STUDY

In the **Model Builder** window, expand the **CMS Study** node.

Time Dependent

- 1 In the **Model Builder** window, expand the **CMS Study > Step 3: Model Reduction** node, then click **Time Dependent**.
- 2 In the **Settings** window for **Time Dependent**, locate the **Physics and Variables Selection** section.
- 3 In the tree, select **Component 1 (comp1) > Solid Mechanics (solid) > Boundary Load 1**.

4 Right-click and choose **Enable**.

Compute the **CMS Study** to generate the reduced components.

5 In the **Study** toolbar, click  **Compute**.

Now, create a study for performing the same analysis as in **Study, Full Model**, but with reduced components.

ADD STUDY

1 In the **Home** toolbar, click  **Add Study** to open the **Add Study** window.

2 Go to the **Add Study** window.

3 Find the **Studies** subsection. In the **Select Study** tree, select **Empty Study**.

4 Click the **Add Study** button in the window toolbar.

5 In the **Home** toolbar, click  **Add Study** to close the **Add Study** window.

STUDY, REDUCED MODEL

In the **Settings** window for **Study**, type **Study, Reduced Model** in the **Label** text field.

STUDY, FULL MODEL

Step 1: Stationary, Step 2: Time Dependent

1 In the **Model Builder** window, under **Study, Full Model**, Ctrl-click to select **Step 1: Stationary** and **Step 2: Time Dependent**.

2 Right-click and choose **Copy**.

STUDY, REDUCED MODEL

In the **Model Builder** window, right-click **Study, Reduced Model** and choose **Paste Multiple Items**.

Boundary Load 1 should not be active in **Study, Reduced Model**, since it is already part of **Reduced Component 2**. Note that **Boundary Load 2** adds a load on both reduced and unreduced parts of the assembly.

Step 1: Stationary

1 In the **Settings** window for **Stationary**, locate the **Physics and Variables Selection** section.

2 Select the **Modify model configuration for study step** checkbox.

3 In the tree, select **Component 1 (comp1) > Solid Mechanics (solid) > Boundary Load 1**.

4 Right-click and choose **Disable**.

Step 2: Time Dependent

- 1 In the **Model Builder** window, click **Step 2: Time Dependent**.
- 2 In the **Settings** window for **Time Dependent**, locate the **Physics and Variables Selection** section.
- 3 Select the **Modify model configuration for study step** checkbox.
- 4 In the tree, select **Component 1 (comp1) > Solid Mechanics (solid) > Boundary Load 1**.
- 5 Right-click and choose **Disable**.

Duplicate **Point Probe 1** to also monitor the vertical displacement when solving the reduced model.



DEFINITIONS

Point Probe 2 (point2)

- 1 In the **Model Builder** window, under **Component 1 (comp1) > Definitions** right-click **Point Probe 1 (point1)** and choose **Duplicate**.
- 2 In the **Settings** window for **Point Probe**, locate the **Expression** section.
- 3 In the **Description** text field, type `Reduced model`.
- 4 Click to expand the **Table and Window Settings** section. From the **Output table** list, choose **New table**.

STUDY, REDUCED MODEL

Step 2: Time Dependent

- 1 In the **Model Builder** window, under **Study, Reduced Model** click **Step 2: Time Dependent**.
- 2 In the **Settings** window for **Time Dependent**, click to expand the **Results While Solving** section.
- 3 From the **Probes** list, choose **Manual**.
- 4 In the **Probes** list box, select **Point Probe 1 (point1)**.
- 5 Under **Probes**, click  **Delete**.
- 6 In the **Study** toolbar, click  **Compute**.

Create plots to visualize the constrained eigenmodes and some of the constraint modes for **Reduced Component 2**. The solution datasets of the CMS study contains the results from the last component in the sweep, where **CMS Study/Solution Store 1** contains the constraint modes and **CMS Study/Solution Store 2** the eigenmodes.

RESULTS

Constrained Eigenmodes

- 1 In the **Results** toolbar, click  **3D Plot Group**.
- 2 In the **Settings** window for **3D Plot Group**, type **Constrained Eigenmodes** in the **Label** text field.
- 3 Locate the **Data** section. From the **Dataset** list, choose **CMS Study/Solution Store 3 (sol5)**.
- 4 Click to expand the **Title** section. From the **Title type** list, choose **None**.
- 5 Locate the **Color Legend** section. Clear the **Show legends** checkbox.
- 6 Click to expand the **Plot Array** section. From the **Array type** list, choose **Square**.
- 7 From the **Order** list, choose **Column-major**.

Volume 1

- 1 Right-click **Constrained Eigenmodes** and choose **Volume**.
- 2 In the **Settings** window for **Volume**, locate the **Coloring and Style** section.
- 3 From the **Color table** list, choose **DiscoLight**.

Deformation 1

Right-click **Volume 1** and choose **Deformation**.

Volume 2

- 1 In the **Model Builder** window, under **Results > Constrained Eigenmodes** right-click **Volume 1** and choose **Duplicate**.
- 2 In the **Settings** window for **Volume**, locate the **Data** section.
- 3 From the **Dataset** list, choose **CMS Study/Solution Store 3 (sol5)**.
- 4 From the **Eigenfrequency (Hz)** list, choose **852.06**.

Volume 3

- 1 Right-click **Volume 2** and choose **Duplicate**.
- 2 In the **Settings** window for **Volume**, locate the **Data** section.
- 3 From the **Eigenfrequency (Hz)** list, choose **1407.1**.



Volume 4

- 1 Right-click **Volume 3** and choose **Duplicate**.
- 2 In the **Settings** window for **Volume**, locate the **Data** section.
- 3 From the **Eigenfrequency (Hz)** list, choose **1680.2**.

Volume 5

- 1 Right-click **Volume 4** and choose **Duplicate**.
- 2 In the **Settings** window for **Volume**, locate the **Data** section.
- 3 From the **Eigenfrequency (Hz)** list, choose **1952.3**.

Volume 6

- 1 Right-click **Volume 5** and choose **Duplicate**.
- 2 In the **Settings** window for **Volume**, locate the **Data** section.
- 3 From the **Eigenfrequency (Hz)** list, choose **2550.5**.
- 4 In the **Constrained Eigenmodes** toolbar, click  **Plot**.
- 5 Click the  **Zoom Extents** button in the **Graphics** toolbar.
- 6 Click the  **Show Grid** button in the **Graphics** toolbar.

Constraint Modes

- 1 In the **Results** toolbar, click  **3D Plot Group**.
- 2 In the **Settings** window for **3D Plot Group**, type **Constraint Modes** in the **Label** text field.
- 3 Locate the **Data** section. From the **Dataset** list, choose **CMS Study/Solution Store 2 (sol4)**.
- 4 Locate the **Title** section. From the **Title type** list, choose **None**.
- 5 Locate the **Color Legend** section. Clear the **Show legends** checkbox.
- 6 Locate the **Plot Array** section. From the **Array type** list, choose **Square**.
- 7 From the **Order** list, choose **Column-major**.

Volume 1

- 1 Right-click **Constraint Modes** and choose **Volume**.
- 2 In the **Settings** window for **Volume**, locate the **Data** section.
- 3 From the **Dataset** list, choose **CMS Study/Solution Store 2 (sol4)**.
- 4 From the **Parameter value (c_rfc1_solid)** list, choose **1**.
- 5 Locate the **Coloring and Style** section. From the **Color table** list, choose **SpectrumLight**.

Deformation 1

Right-click **Volume 1** and choose **Deformation**.

Volume 2

- 1 In the **Model Builder** window, under **Results > Constraint Modes** right-click **Volume 1** and choose **Duplicate**.

- 2 In the **Settings** window for **Volume**, locate the **Data** section.
- 3 From the **Parameter value (c_rfc1_solid)** list, choose **2**.

Volume 3

- 1 Right-click **Volume 2** and choose **Duplicate**.
- 2 In the **Settings** window for **Volume**, locate the **Data** section.
- 3 From the **Parameter value (c_rfc1_solid)** list, choose **3**.



Volume 4

- 1 Right-click **Volume 3** and choose **Duplicate**.
- 2 In the **Settings** window for **Volume**, locate the **Data** section.
- 3 From the **Parameter value (c_rfc1_solid)** list, choose **4**.

Volume 5



- 1 Right-click **Volume 4** and choose **Duplicate**.
- 2 In the **Settings** window for **Volume**, locate the **Data** section.
- 3 From the **Parameter value (c_rfc1_solid)** list, choose **5**.

Volume 6

- 1 Right-click **Volume 5** and choose **Duplicate**.
- 2 In the **Settings** window for **Volume**, locate the **Data** section.
- 3 From the **Parameter value (c_rfc1_solid)** list, choose **6**.
- 4 In the **Constraint Modes** toolbar, click  **Plot**.
- 5 Click the  **Zoom Extents** button in the **Graphics** toolbar.



Modify the default stress plots to show the stress level when all loads are applied.

Stress (solid)

- 1 In the **Model Builder** window, under **Results** click **Stress (solid)**.
- 2 In the **Settings** window for **3D Plot Group**, locate the **Data** section.
- 3 From the **Time (s)** list, choose **0**.
- 4 In the **Stress (solid)** toolbar, click  **Plot**.
- 5 Click the  **Zoom Extents** button in the **Graphics** toolbar.

Stress (solid) 1

- 1 In the **Model Builder** window, click **Stress (solid) 1**.
- 2 In the **Settings** window for **3D Plot Group**, locate the **Data** section.
- 3 From the **Time (s)** list, choose **0**.

- 4 In the **Stress (solid) I** toolbar, click  **Plot**.
- 5 Click the  **Zoom Extents** button in the **Graphics** toolbar.

To be able to recompute **Study, Full Model** with the same setting as before, disable **Reduced Flexible Components** and the ROMs that were added for **Study, Reduced Model**.

STUDY, FULL MODEL

Step 1: Stationary

- 1 In the **Model Builder** window, under **Study, Full Model** click **Step 1: Stationary**.
- 2 In the **Settings** window for **Stationary**, locate the **Physics and Variables Selection** section.
- 3 Select the **Modify model configuration for study step** checkbox.
- 4 In the tree, select **Global Definitions > Reduced-Order Modeling > Reduced Component 1 (rom1_n_rfcl_solid_1)** and **Global Definitions > Reduced-Order Modeling > Reduced Component 2 (rom1_n_rfcl_solid_2)**.
- 5 Right-click and choose **Disable in Model**.
- 6 In the tree, select **Component 1 (comp1) > Solid Mechanics (solid) > Reduced Flexible Components 1**.
- 7 Right-click and choose **Disable**.

Step 2: Time Dependent

- 1 In the **Model Builder** window, click **Step 2: Time Dependent**.
- 2 In the **Settings** window for **Time Dependent**, click to expand the **Results While Solving** section.
- 3 From the **Probes** list, choose **Manual**.
- 4 In the **Probes** list box, select **Point Probe 2 (point2)**.
- 5 Under **Probes**, click  **Delete**.
- 6 Locate the **Physics and Variables Selection** section. Select the **Modify model configuration for study step** checkbox.
- 7 In the tree, select **Global Definitions > Reduced-Order Modeling > Reduced Component 1 (rom1_n_rfcl_solid_1)** and **Global Definitions > Reduced-Order Modeling > Reduced Component 2 (rom1_n_rfcl_solid_2)**.
- 8 Right-click and choose **Disable in Model**.
- 9 In the tree, select **Component 1 (comp1) > Solid Mechanics (solid) > Reduced Flexible Components 1**.
- 10 Right-click and choose **Disable**.

