



Model created in COMSOL Multiphysics 6.4

Stress Analysis of a Pipe Fitting from a CAD File

Introduction

The stress analysis of a threaded connection is usually a complex undertaking because of the presence of fine geometrical details. One way to simplify the problem is to assume that the thread is axisymmetric. Computing the solution on a 2D cross section requires much less computational resources. This tutorial shows how to obtain a 2D cross section from a 3D geometry in order to perform stress analysis of a threaded pipe fitting. The 3D geometry of the fitting (see [Figure 1](#)) comes from a Solid Edge assembly, and is synchronized using the LiveLink interface.

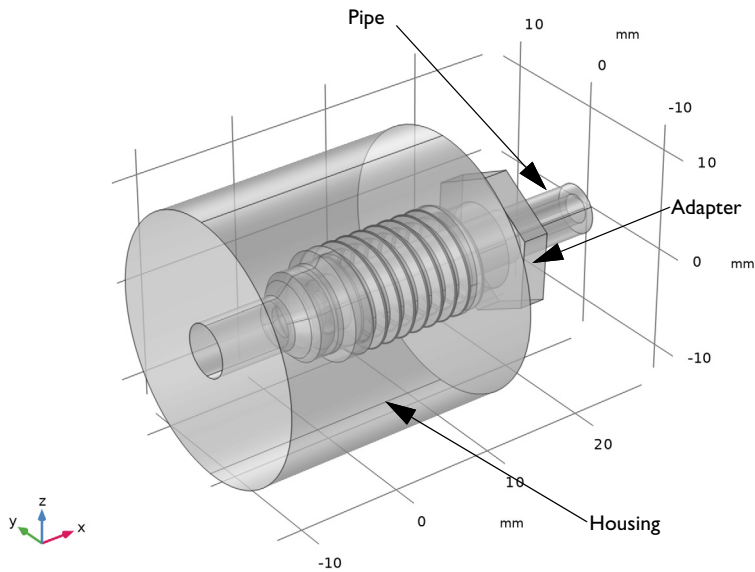

Figure 1: The 3D geometry of the pipe fitting used in this tutorial.

Model Definition

The simulation is performed on the 2D cross section of the geometry seen in [Figure 2](#).

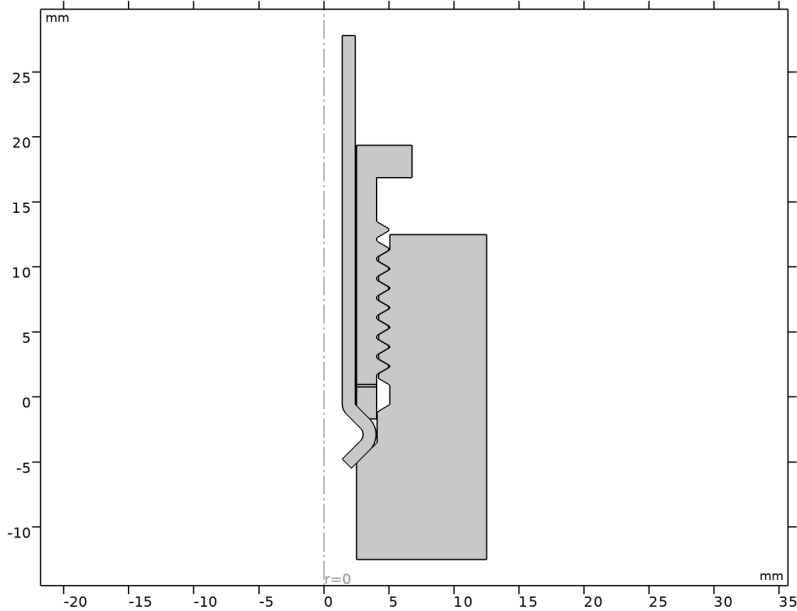

Figure 2: 2D cross section of the pipe fitting used for the simulation.

The analysis is based on a benchmark described in [Ref. 1](#), where a 5 Nm torque is applied to the adapter. All components are made of the same steel material.

For this 2D axisymmetric simulation it is not an option to apply the torque to the adapter component. Instead an axial preload (W) can be applied based on the torque (T) as outlined in [Ref. 1](#):

$$W = \left[\frac{2T \cdot (1 - \mu \cdot A \cdot \sec(\beta))}{d_0 \cdot (A + \mu \cdot \sec(\beta)) + \mu \cdot \sec(0,7854) \cdot d_1 \cdot (1 - \mu \cdot A \cdot \sec(\beta))} \right]$$

where μ is the friction coefficient, β the semi thread angle, d_0 the thread mean diameter, d_1 the abutment shoulder mean diameter and A the tangent of the helix angle.

The bolt pretension is ensured by means of an initial strain in the z direction set in a pretension domain, see the figure below:

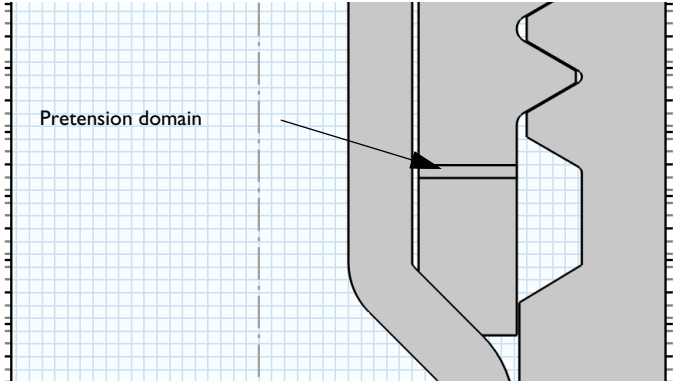

The applied initial strain in the z direction is automatically adjusted so that the integrated stress along the z direction equals the calculated preload.

The model uses contact pairs to compute the force transmission between each part of the assembly.

Results and Discussion

The von Mises stress for the maximum applied torque, 5 Nm, is plotted in [Figure 3](#). The maximum value of the von Mises stress is below the yield stress for a class 10.9 alloy steel.

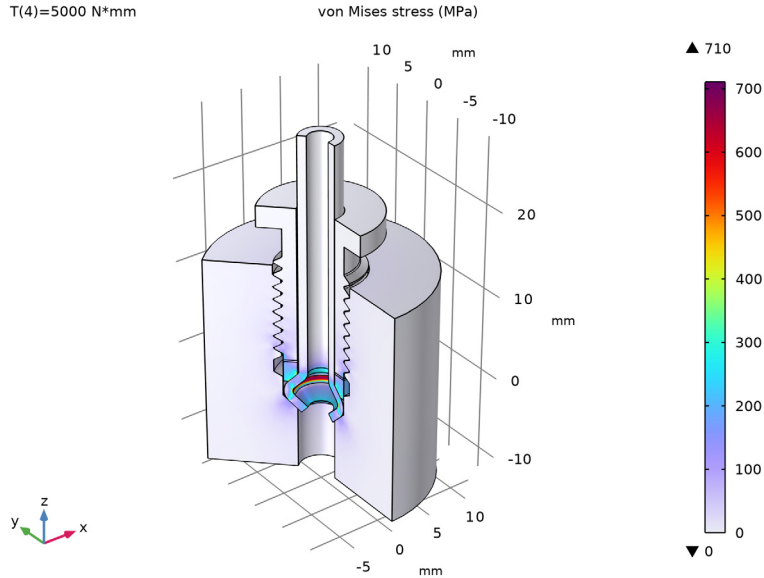

Figure 3: The von Mises stress at the maximum applied torque.

Notes About the COMSOL Implementation

To generate the 2D cross section of the synchronized 3D geometry the Cross Section geometry operation is applied. This operation also maps the selections from the 3D geometry to the 2D geometry. The selections on the 3D geometry are defined in the Solid Edge files and synchronized by the LiveLink interface.

TABLE 1: SELECTIONS DEFINED IN THE SOLIDWORKS FILES.

NAME	TYPE	DEFINED IN FILE
Faceset1.pipe	boundary	pipe_fitting.asm
Faceset2.pipe	boundary	pipe_fitting.asm
Faceset1.adaptor	boundary	pipe_fitting.asm
Faceset2.adaptor	boundary	pipe_fitting.asm
Pre-tension domain	object	pipe_fitting.asm

TABLE 1: SELECTIONS DEFINED IN THE SOLIDWORKS FILES.

NAME	TYPE	DEFINED IN FILE
Facetset1.housing	boundary	pipe_fitting.asm
Facetset2.housing	boundary	pipe_fitting.asm
Male fitting	object	pipe_fitting.asm

To view the selection in the Solid Edge user interface, click the **Selections** button on the **COMSOL Multiphysics** tab. The selections defined in the component files are automatically loaded and displayed also for the assembly, and they are synchronized during synchronization of the assembly with the COMSOL model.

Reference

1. J. Smart, “NAFEMS Advanced Workbook of Examples and Case Studies (Volume 2)” *NAFEMS R0086*, 2003.

Application Library path: LiveLink_for_Solid_Edge/Tutorials, _LiveLink_Interface/pipe_fitting_llse



Modeling Instructions

- 1 In Solid Edge open the file pipe_fitting_cad/pipe_fitting.asm located in the model’s Application Library folder.
- 2 Switch to the COMSOL Desktop.
- 3 From the **File** menu, choose **New**.

NEW

In the **New** window, click  **Model Wizard**.

MODEL WIZARD

- 1 In the **Model Wizard** window, click  **3D**.
- 2 Click  **Done**.

GEOMETRY I

Make sure that the CAD Import Module kernel is used.

- 1 In the **Model Builder** window, under **Component 1 (comp1)** click **Geometry 1**.

- 2 In the **Settings** window for **Geometry**, locate the **Advanced** section.
- 3 From the **Geometry representation** list, choose **CAD kernel**.
 Disable the automatic detection of small details as the 3D geometry is not used.
- 4 Locate the **Cleanup** section. Clear the **Automatic detection of small details** checkbox.

LiveLink for Solid Edge I (cad1)

- 1 In the **Home** toolbar, click  **LiveLink** and choose **LiveLink for Solid Edge**.
- 2 In the **Settings** window for **LiveLink for Solid Edge**, locate the **Synchronize** section.
- 3 Click **Synchronize**.
- 4 Click to expand the **Object Selections** section. Click to expand the **Boundary Selections** section. The selections listed in these sections are defined on the geometry in the Solid Edge assembly. For more details see *Notes About the COMSOL Implementation*.

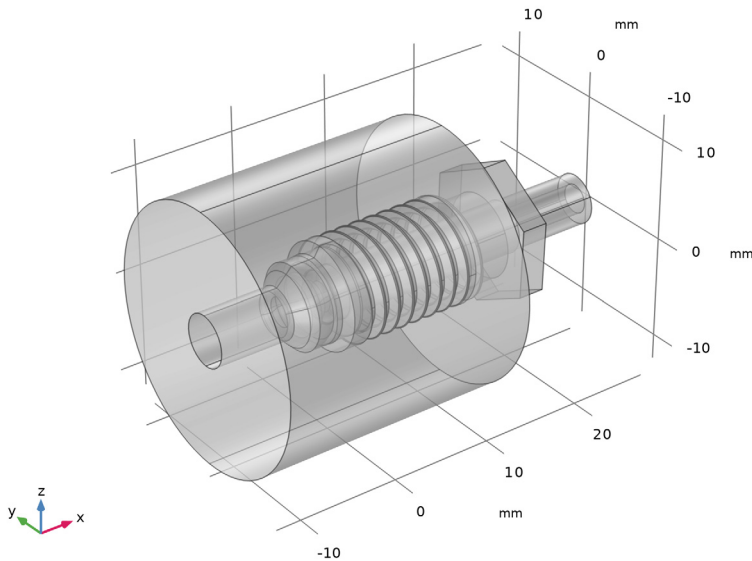

Work Plane 1 (wp1)

- 1 In the **Geometry** toolbar, click  **Work Plane**.
- 2 In the **Settings** window for **Work Plane**, locate the **Plane Definition** section.
- 3 From the **Plane** list, choose **zx-plane**.

ADD COMPONENT

In the **Model Builder** window, right-click the root node and choose **Add Component > 2D Axisymmetric**.

GEOMETRY 2

1 In the **Settings** window for **Geometry**, locate the **Units** section.

2 From the **Length unit** list, choose **mm**.

Cross Section 1 (cro1)

1 In the **Geometry** toolbar, click  **Cross Section**.

2 In the **Settings** window for **Cross Section**, locate the **Selections of Resulting Entities** section.

3 Select the **Selections from 3D** checkbox.

4 Click  **Build Selected**.

Union 1 (uni1)

1 In the **Geometry** toolbar, click  **Booleans and Partitions** and choose **Union**.

2 In the **Settings** window for **Union**, locate the **Union** section.

3 From the **Input objects** list, choose **Male fitting (Cross Section 1)**.

Form Union (fin)

1 In the **Model Builder** window, under **Component 2 (comp2) > Geometry 2** click **Form Union (fin)**.

2 In the **Settings** window for **Form Union/Assembly**, locate the **Form Union/Assembly** section.

3 From the **Action** list, choose **Form an assembly**.



4 Clear the **Create pairs** checkbox.

Warning 1 (warning!)

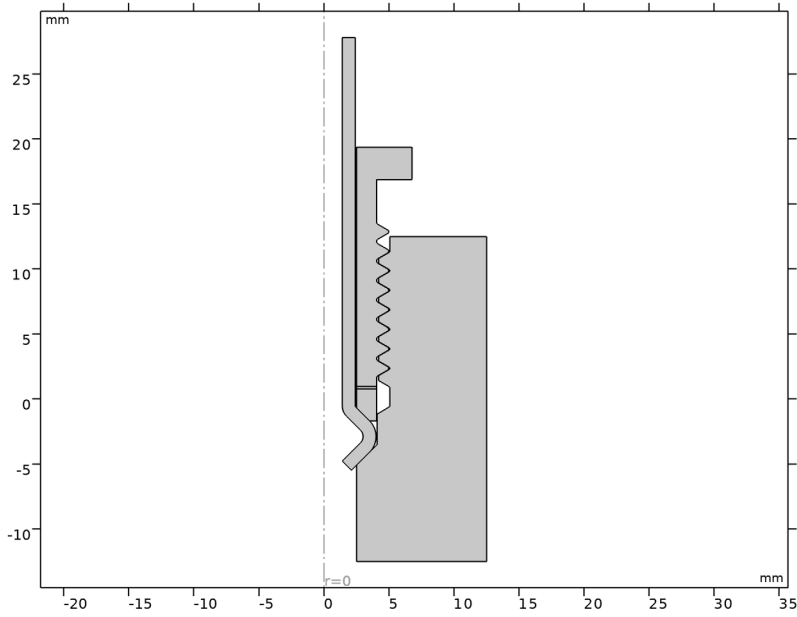

In the **Geometry** toolbar, click  **Build All**.



ADD MATERIAL

- 1 In the **Materials** toolbar, click  **Add Material** to open the **Add Material** window.
- 2 Go to the **Add Material** window.
- 3 In the tree, select **Built-in** > **Structural steel**.
- 4 Right-click and choose **Add to Component 2 (comp2)**.
- 5 In the **Materials** toolbar, click  **Add Material** to close the **Add Material** window.

ADD PHYSICS

- 1 In the **Home** toolbar, click  **Add Physics** to open the **Add Physics** window.
- 2 Go to the **Add Physics** window.
- 3 In the tree, select **Structural Mechanics** > **Solid Mechanics (solid)**.
- 4 Click the **Add to Component 2** button in the window toolbar.
- 5 In the **Home** toolbar, click  **Add Physics** to close the **Add Physics** window.

DEFINITIONS (COMP2)

Contact Pair 1 (p1)

- 1 In the **Definitions** toolbar, click  **Pairs** and choose **Contact Pair**.
- 2 In the **Settings** window for **Pair**, locate the **Source Boundaries** section.
- 3 From the **Selection** list, choose **Faceset2.pipe (Cross Section 1)**.
- 4 Locate the **Destination Boundaries** section. From the **Selection** list, choose **Faceset2.adaptor (Cross Section 1)**.

Contact Pair 2 (p2)

- 1 In the **Definitions** toolbar, click  **Pairs** and choose **Contact Pair**.
- 2 In the **Settings** window for **Pair**, locate the **Source Boundaries** section.
- 3 From the **Selection** list, choose **Faceset1.housing (Cross Section 1)**.
- 4 Locate the **Destination Boundaries** section. From the **Selection** list, choose **Faceset1.adaptor (Cross Section 1)**.

Contact Pair 3 (p3)

- 1 In the **Definitions** toolbar, click  **Pairs** and choose **Contact Pair**.
- 2 In the **Settings** window for **Pair**, locate the **Source Boundaries** section.
- 3 From the **Selection** list, choose **Faceset2.housing (Cross Section 1)**.
- 4 Locate the **Destination Boundaries** section. From the **Selection** list, choose **Faceset1.pipe (Cross Section 1)**.

SOLID MECHANICS (SOLID)

Contact 1a

- 1 In the **Physics** toolbar, click  **Pairs** and choose **Contact**.
- 2 In the **Settings** window for **Contact**, locate the **Pair Selection** section.
- 3 Click **+ Add**.
- 4 In the **Add** dialog, in the **Pairs** list, choose **Contact Pair 1 (p1)**, **Contact Pair 2 (p2)**, and **Contact Pair 3 (p3)**.
- 5 Click **OK**.
- 6 In the **Settings** window for **Contact**, locate the **Contact Method** section.
- 7 From the list, choose **Augmented Lagrangian**.

Friction 1

- 1 In the **Physics** toolbar, click  **Attributes** and choose **Friction**.

- 2 In the **Settings** window for **Friction**, locate the **Friction Parameters** section.
- 3 In the μ text field, type mu.

Roller 1

- 1 In the **Physics** toolbar, click  **Boundaries** and choose **Roller**.
- 2 Select Boundary 14 only.

GLOBAL DEFINITIONS

Parameters 1

Continue with loading the parameters used for setting up the simulation.

- 1 In the **Model Builder** window, under **Global Definitions** click **Parameters 1**.
- 2 In the **Settings** window for **Parameters**, locate the **Parameters** section.
- 3 Click  **Load from File**.
- 4 Browse to the model's Application Libraries folder and double-click the file pipe_fitting_parameters.txt.

DEFINITIONS (COMP2)

Integration 1 (intop1)

- 1 In the **Definitions** toolbar, click  **Nonlocal Couplings** and choose **Integration**.
- 2 In the **Settings** window for **Integration**, locate the **Source Selection** section.
- 3 From the **Selection** list, choose **Pre-tension domain (Cross Section 1)**.
- 4 Locate the **Advanced** section. From the **Frame** list, choose **Material (R, PHI, Z)**.

SOLID MECHANICS (SOLID)



- 1 Click the  **Show More Options** button in the **Model Builder** toolbar.
- 2 In the **Show More Options** dialog, in the tree, select the checkbox for the node **Physics > Equation Contributions**.
- 3 Click **OK**.

Global Equations 1 (ODE1)

- 1 In the **Physics** toolbar, click  **Global** and choose **Global Equations**.
- 2 In the **Settings** window for **Global Equations**, locate the **Global Equations** section.

3 In the table, enter the following settings:



Name	f(u,ut,utt,t) (I)	Initial value (u_0) (I)	Initial value (ut_0) (I/s)	Description
eZ	intop1(solid.SZ/0.2[mm])+W	0.1	0	

- 4 Locate the **Units** section. Click  **Select Dependent Variable Quantity**.
- 5 In the **Physical Quantity** dialog, select **Solid Mechanics > Strain tensor (I)** in the tree.
- 6 Click **OK**.
- 7 In the **Settings** window for **Global Equations**, locate the **Units** section.
- 8 Click  **Select Source Term Quantity**.
- 9 In the **Physical Quantity** dialog, select **General > Force (N)** in the tree.
- 10 Click **OK**.

Linear Elastic Material I

In the **Model Builder** window, click **Linear Elastic Material I**.

Initial Stress and Strain I

- 1 In the **Physics** toolbar, click  **Attributes** and choose **Initial Stress and Strain**.
- 2 In the **Settings** window for **Initial Stress and Strain**, locate the **Domain Selection** section.
- 3 Click  **Clear Selection**.
- 4 From the **Selection** list, choose **Pre-tension domain (Cross Section I)**.
- 5 Locate the **Initial Stress and Strain** section. Specify the ϵ_0 matrix as

0	0	0
0	0	0
0	0	eZ

Spring Foundation I

- 1 In the **Physics** toolbar, click  **Boundaries** and choose **Spring Foundation**.
- 2 Select Boundaries 5 and 63 only.
- 3 In the **Settings** window for **Spring Foundation**, locate the **Spring** section.
- 4 From the list, choose **Diagonal**.

5 Specify the \mathbf{k}_A matrix as

0	0
0	k



MESH 2

- 1 In the **Model Builder** window, under **Component 2 (comp2)** click **Mesh 2**.
- 2 In the **Settings** window for **Mesh**, locate the **Sequence Type** section.
- 3 From the list, choose **User-controlled mesh**.

Size 1

- 1 In the **Model Builder** window, right-click **Free Triangular 1** and choose **Size**.
- 2 In the **Settings** window for **Size**, locate the **Geometric Entity Selection** section.
- 3 From the **Geometric entity level** list, choose **Boundary**.
- 4 From the **Selection** list, choose **Faceset2.adaptor (Cross Section 1)**.
- 5 Locate the **Element Size** section. Click the **Custom** button.
- 6 Locate the **Element Size Parameters** section.
- 7 Select the **Maximum element size** checkbox. In the associated text field, type 0.1.
- 8 Click  **Build All**.

ADD STUDY

- 1 In the **Home** toolbar, click  **Add Study** to open the **Add Study** window.
- 2 Go to the **Add Study** window.
- 3 Find the **Studies** subsection. In the **Select Study** tree, select **General Studies > Stationary**.
- 4 Right-click and choose **Add Study**.
- 5 In the **Home** toolbar, click  **Add Study** to close the **Add Study** window.

STUDY 1

Step 1: Stationary

- 1 In the **Settings** window for **Stationary**, click to expand the **Mesh Selection** section.
- 2 In the table, enter the following settings:

Component	Mesh
Component 1	No mesh

- 3 Click to expand the **Study Extensions** section. Select the **Auxiliary sweep** checkbox.

4 Click  **Add**.

5 In the table, enter the following settings:

Parameter name	Parameter value list	Parameter unit
T (Applied torque)	100 500 1e3 5e3	N*mm

Solution I (sol1)

1 In the **Study** toolbar, click  **Show Default Solver**.

2 In the **Model Builder** window, expand the **Solution I (sol1)** node.

3 In the **Model Builder** window, expand the **Study I > Solver Configurations > Solution I (sol1) > Stationary Solver I > Segregated I** node, then click **Solid Mechanics**.

4 In the **Settings** window for **Segregated Step**, click to expand the **Method and Termination** section.

5 From the **Termination technique** list, choose **Tolerance**.

6 In the **Study** toolbar, click  **Compute**.

RESULTS

Stress (solid)

The first automatically generated plot group contains a surface plot of the von Mises stress, and a line plot of the contact pressure.

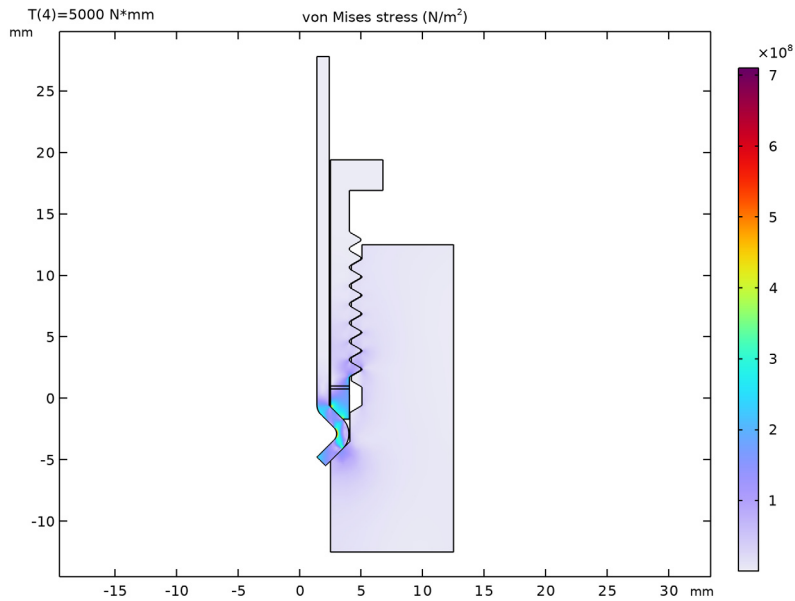

Stress, 3D (solid)

To visualize the solution in 3D, a plot is also generated based on a revolution dataset.

Surface 1

- 1 In the **Model Builder** window, expand the **Stress, 3D (solid)** node, then click **Surface 1**.
- 2 In the **Settings** window for **Surface**, locate the **Expression** section.
- 3 From the **Unit** list, choose **MPa**.

Stress, 3D (solid)

- 1 In the **Model Builder** window, click **Stress, 3D (solid)**.
- 2 In the **Settings** window for **3D Plot Group**, locate the **Color Legend** section.
- 3 Select the **Show maximum and minimum values** checkbox.

The results plot should now appear similar to that in [Figure 3](#)