



Model created in COMSOL Multiphysics 6.4

# Pacemaker Electrode

## *Introduction*

---

This example illustrates the use of COMSOL Multiphysics for modeling of ionic current distribution problems in electrolytes, in this case in human tissue. The problem is exemplified on a pacemaker electrode, but it can be applied in electrochemical cells like fuel cells, batteries, corrosion protection, or any other process where ionic conduction takes place in the absence of concentration gradients.

By using the LiveLink interface for Inventor you can study the influence of the design of the electrode on the current distribution. The model demonstrates how to synchronize the geometry between Inventor and COMSOL Multiphysics while updating dimensional parameters, and how to perform an automatic parametric sweep.

The modeled device is a pacemaker electrode that is placed inside the heart and helps the patient's heart to keep a normal rhythm. The device is referred to as an electrode, but it actually consists of two electrodes: a cathode and an anode.

[Figure 1](#) shows a schematic drawing of two pair of electrodes placed inside the heart. The electrodes are supplied with current from the pulse generator unit, which is also implanted in the patient.

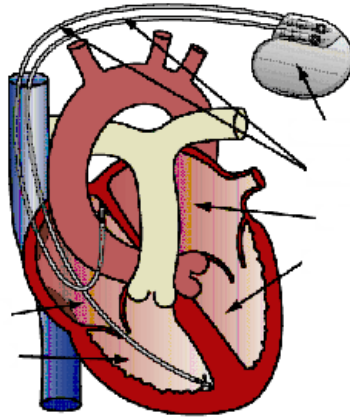

*Figure 1: Schematic drawing of the heart with two pairs of pacemaker electrodes.*

This example deals with the current and potential distribution around one pair of electrodes.

## Model Definition

---

The model domain consists of the blood and tissue surrounding the electrode pair. The actual electrodes and the electrode support are boundaries to the modeled domain.

Figure 2 shows the electrode in a darker shade, while the surrounding modeling domain is shown in a lighter shade.

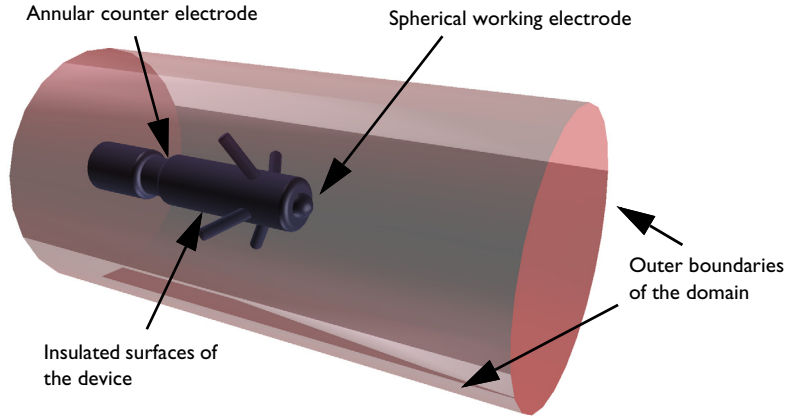

Figure 2: Modeling domain and boundaries.

The working electrode consists of a hemisphere placed on the tip of the supporting cylindrical structure. The counter electrode is placed in the “waist” of this structure. All other surfaces of the supporting structure are insulated. The outer boundaries are placed far enough from the electrode to give a small impact on the current and potential distribution.

In COMSOL Multiphysics, use the Electric Currents interface for the analysis of the electrode. This physics interface is useful for modeling conductive materials where a current flows due to an applied electric field.

### DOMAIN EQUATIONS

The current in the domain is controlled by the continuity equation, which follows from Maxwell’s equations:

$$-\nabla \cdot (\sigma \nabla V) = 0$$

where  $\sigma$  is the conductivity of the human heart. This equation uses the following relations between the electric potential and the fields.

$$\mathbf{E} = -\nabla V$$

$$\mathbf{J} = \sigma \mathbf{E}$$

### BOUNDARY CONDITIONS

Ground potential boundary conditions are applied on the thinner waist of the electrode. The tip of the electrode has a fixed potential of 1 V. All other boundaries are electrically insulated.

$$\mathbf{n} \cdot \mathbf{J} = 0$$

### Results and Discussion

This simulation gives the potential distribution on the electrode surface and streamlines of the current distribution inside the human heart; see Figure 3. ,

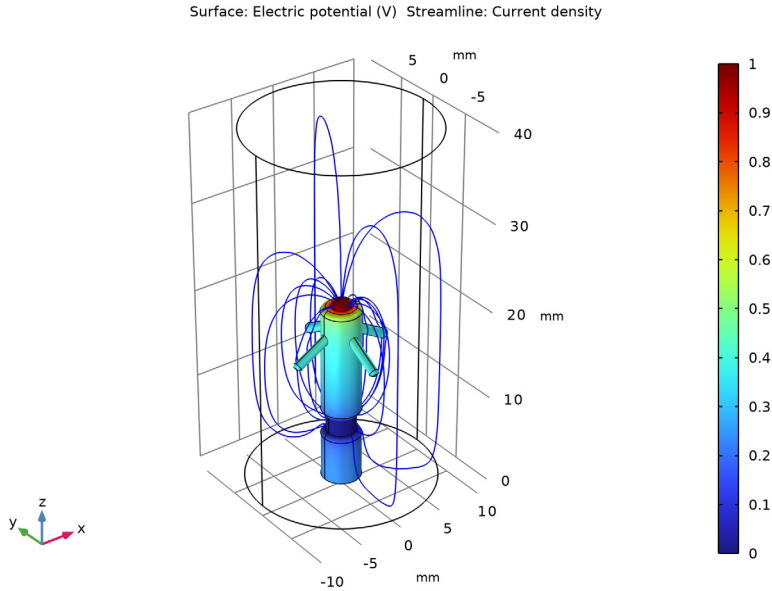
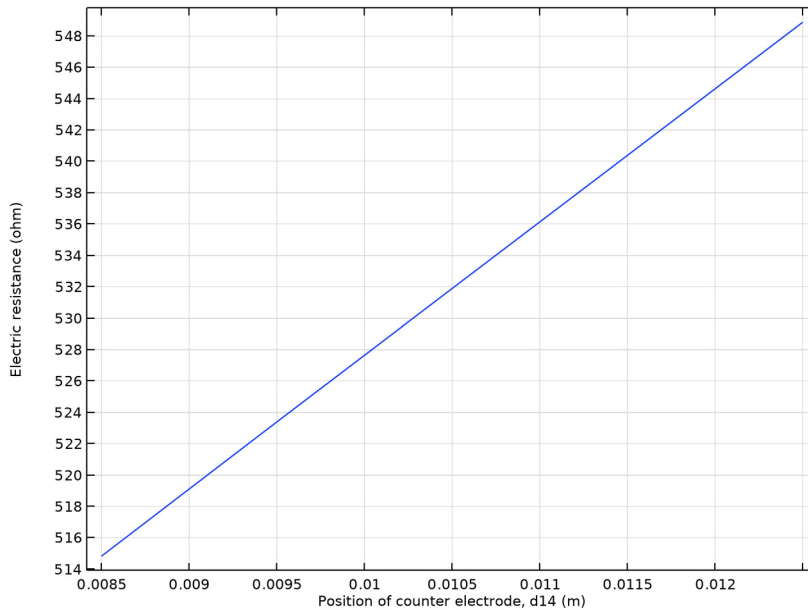

*Figure 3: The plot shows the electrostatic potential distributed on the surface of the electrode. The total current density is shown as streamlines.*

As expected, the current density is highest at the small hemisphere, which is the one that causes the excitation of the heart. The current density is fairly uniform on the working electrode. The counter electrode is larger and there are also larger variations in current density on its surface. Mainly, the current is lower with the distance from the working

electrode. The model shows that the anchoring arms of the device have little influence on the current density distribution.

Moving the location of the counter electrode closer to the anchoring arms on the device have little influence on the current distribution. The position of the counter electrode affects the electric resistance of the pacemaker electrode, which is important when designing the electrical circuit, in which the pacemaker electrode is included; see [Figure 4](#), which shows a plot of the electric resistance of the pacemaker electrode for different values of the distance between counter electrode and working electrode.



*Figure 4: The plot shows the electric resistance of the pacemaker electrode in relation to the distance between the counter electrode and the working electrode.*

### *Notes About the COMSOL Implementation*

---

The pacemaker electrode geometry you are using in this model comes from an Inventor part. The LiveLink interface transfers the geometry from Inventor to COMSOL Multiphysics. Using the interface you are also able to update the dimension of the electrode in the Inventor file. In order for this to work you need to have both programs running during modeling, and you need to make sure that the file of the pacemaker electrode is the active file in Inventor.

---

**Application Library path:** LiveLink\_for\_Inventor/Tutorials,  
\_LiveLink\_Interface/pacemaker\_electrode\_1linventor

---

### *Modeling Instructions*

---

You can set up this simulation both by working inside Inventor, using the embedded COMSOL simulation environment, and by working in the standalone COMSOL Desktop. Regardless which way you proceed, first you need to open the CAD file with the geometry in Inventor.

- 1 In Inventor open the file `pacemaker_electrode.ipt` located in the model's Application Library folder.
- 2 Switch to the COMSOL Desktop, and skip the next section. Or, continue below if you are working inside Inventor.

#### **MODELING INSIDE INVENTOR**

- 1 On the **COMSOL Multiphysics** tab click the **New** button.  
In case it is not already running, the COMSOL modeling environment will be started, and the geometry will be synchronized automatically.
- 2 Continue with step 2 under the Model Wizard section.



#### **COMSOL DESKTOP**

From the **File** menu, choose **New**.

#### **NEW**

In the **New** window, click  **Model Wizard**.

#### **MODEL WIZARD**

- 1 In the **Model Wizard** window, click  **3D**.
- 2 In the **Select Physics** tree, select **AC/DC** > **Electric Fields and Currents** > **Electric Currents (ec)**.
- 3 Click **Add**.
- 4 Click  **Study**.
- 5 In the **Select Study** tree, select **General Studies** > **Stationary**.
- 6 Click  **Done**.

## GEOMETRY 1

The geometry is already synchronized if you are modeling inside Inventor.

After launching the One Window interface the last added physics interface is the current node in the **Model Builder**. To follow the instructions below, expand the **Geometry 1** node and select **Geometry from Inventor (cad)**. Skip to step 4 in the section LiveLink for Inventor 1 (cad1).

Make sure that the CAD Import Module kernel is used.

- 1 In the **Model Builder** window, under **Component 1 (comp1)** click **Geometry 1**.
- 2 In the **Settings** window for **Geometry**, locate the **Advanced** section.
- 3 From the **Geometry representation** list, choose **CAD kernel**.

*LiveLink for Inventor 1 (cad1)*

- 1 Right-click **Component 1 (comp1)** > **Geometry 1** and choose **LiveLink Interfaces** > **LiveLink for Inventor**.
- 2 In the **Settings** window for **LiveLink for Inventor**, locate the **Synchronize** section.
- 3 Click **Synchronize**.

After a few moments the geometry of the pacemaker electrode appears in the **Graphics** window.

- 4 Click the  **Transparency** button in the **Graphics** toolbar.

If you are modeling inside Inventor, change to wireframe visualization

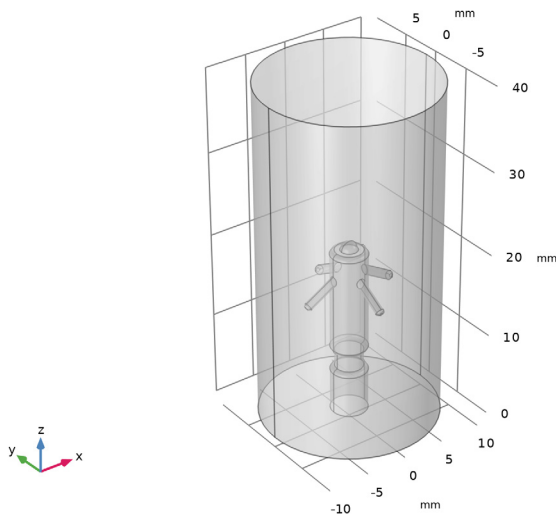

- 5 Click to expand the **Parameters in CAD Package** section. The dimensional parameter for the position of the counter electrode, `d14` in the Inventor file, has been linked to COMSOL Multiphysics and is therefore synchronized with the geometry. To manage linked parameters, you can click **Parameter Selection** on the **COMSOL Multiphysics** tab in Inventor. The global parameter, `LL_d14`, is automatically generated in the COMSOL Multiphysics model during synchronization to enable parametric sweeps and optimization of the geometry.
- 6 Click to expand the **Boundary Selections** section. The selections listed here are user defined selections saved in the Inventor file. In Inventor, you can set up selections using the **Selections** button on the **COMSOL Multiphysics** tab.  
Both sections are only visible by working in the standalone COMSOL Desktop.

## GLOBAL DEFINITIONS

### *Parameters 1*

The table already contains the automatically generated global parameter that is linked to the dimension inside Inventor. It is possible to edit the value of the parameter here, and then synchronize, to modify the geometry. But in this tutorial we will use the parametric solver to automatically solve the model for a range of parameter values.

Continue with loading additional parameters for setting up the physics.

- 1 In the **Model Builder** window, under **Global Definitions** click **Parameters 1**.
- 2 In the **Settings** window for **Parameters**, locate the **Parameters** section.
- 3 Click  **Load from File**.
- 4 Browse to the model's Application Libraries folder and double-click the file `pacemaker_electrode_parameters.txt`.

## DEFINITIONS

### *Integration 1 (intop1)*

The integration operator you will set up in the next steps is used to evaluate the electric resistance of the pacemaker electrode.

- 1 In the **Model Builder** window, under **Component 1 (comp1)** right-click **Definitions** and choose **Nonlocal Couplings > Integration**.
- 2 In the **Settings** window for **Integration**, type `my_int` in the **Operator name** text field.
- 3 Locate the **Source Selection** section. From the **Geometric entity level** list, choose **Boundary**.

- 4 From the **Selection** list, choose **Counter electrode**.
- 5 Locate the **Advanced** section. From the **Method** list, choose **Summation over nodes**.

## MATERIALS

### *Heart Tissue*

- 1 In the **Model Builder** window, under **Component 1 (comp1)** right-click **Materials** and choose **Blank Material**.
- 2 In the **Settings** window for **Material**, locate the **Material Contents** section.
- 3 In the table, enter the following settings:

Property	Variable	Value	Unit	Property group
Electric conductivity	sigma_iso ; sigma_ii = sigma_iso, sigma_ij = 0	el_cond	S/m	Basic
Relative permittivity	epsilon_nr_iso ; epsilon_rii = epsilon_nr_iso, epsilon_rij = 0	rel_perm	1	Basic

- 4 Right-click **Material 1 (mat1)** and choose **Rename**.
- 5 In the **Rename Material** dialog, type Heart Tissue in the **New label** text field.
- 6 Click **OK**.

## ELECTRIC CURRENTS (EC)

### *Ground 1*

- 1 In the **Model Builder** window, under **Component 1 (comp1)** right-click **Electric Currents (ec)** and choose **Ground**.
- 2 In the **Settings** window for **Ground**, locate the **Boundary Selection** section.
- 3 From the **Selection** list, choose **Counter electrode**.

### *Electric Potential 1*

- 1 In the **Model Builder** window, right-click **Electric Currents (ec)** and choose **Electric Potential**.
- 2 In the **Settings** window for **Electric Potential**, locate the **Boundary Selection** section.
- 3 From the **Selection** list, choose **Working electrode**.

4 Locate the **Electric Potential** section. In the  $V_0$  text field, type  $V_{tot}$ .

### MESH I

- 1 In the **Model Builder** window, under **Component 1 (comp1)** click **Mesh 1**.
- 2 In the **Settings** window for **Mesh**, locate the **Physics-Controlled Mesh** section.
- 3 From the **Element size** list, choose **Fine**.
- 4 Click  **Build All**.

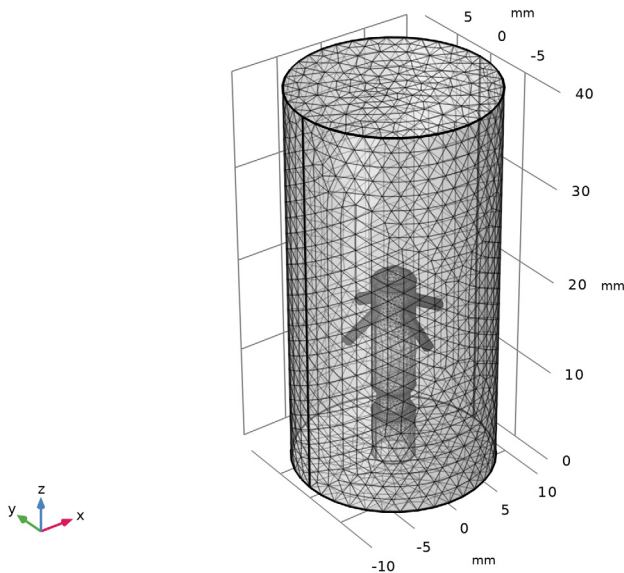

### STUDY I

In the **Model Builder** window, right-click **Study 1** and choose **Compute**.

### RESULTS

#### *Evaluation Group 1*

In the **Model Builder** window, right-click **Results** and choose **Evaluation Group**.

#### *Global Evaluation 1*

- 1 In the **Model Builder** window, right-click **Evaluation Group 1** and choose **Global Evaluation**.
- 2 In the **Settings** window for **Global Evaluation**, locate the **Expressions** section.

3 In the table, enter the following settings:

Expression	Unit	Description
$-V_{tot}/m_y\_int(\text{reacf}(V)) [A]$	$\Omega$	

4 Click  **Evaluate**.

#### *3D Plot Group 3*

In the **Model Builder** window, right-click **Results** and choose **3D Plot Group**.

#### *Surface 1*

In the **Model Builder** window, right-click **3D Plot Group 3** and choose **Surface**.

#### *Selection 1*

1 In the **Model Builder** window, right-click **Surface 1** and choose **Selection**.

2 In the **Settings** window for **Selection**, locate the **Selection** section.

3 From the **Selection** list, choose **Pacemaker**.

#### *Streamline 1*

1 In the **Model Builder** window, right-click **3D Plot Group 3** and choose **Streamline**.

2 In the **Settings** window for **Streamline**, locate the **Streamline Positioning** section.

3 From the **Positioning** list, choose **Starting-point controlled**.

4 Locate the **Coloring and Style** section. Find the **Point style** subsection. From the **Color** list, choose **Blue**.

5 Click  **Plot**.

6 Click the  **Transparency** button in the **Graphics** toolbar.

You should see a plot similar to the plot in [Figure 3](#).

## STUDY 1

#### *Parametric Sweep*

1 In the **Model Builder** window, right-click **Study 1** and choose **Parametric Sweep**.

2 In the **Settings** window for **Parametric Sweep**, locate the **Study Settings** section.

3 Click  **Add**.

4 Click  **Range**.

5 In the **Range** dialog, type 8.5[mm] in the **Start** text field.

6 In the **Step** text field, type 1[mm].

7 In the **Stop** text field, type 12.5[mm].

- 8 Click **Add**.
- 9 Right-click **Study 1** and choose **Compute**.

## RESULTS

### *Evaluation Group 1*

- 1 In the **Model Builder** window, click **Evaluation Group 1**.
- 2 In the **Settings** window for **Evaluation Group**, locate the **Data** section.
- 3 From the **Dataset** list, choose **Study 1/Parametric Solutions 1 (sol2)**.
- 4 Click  **Evaluate**.

## EVALUATION GROUP 1

- 1 Go to the **Evaluation Group 1** window.
- 2 Click the **Table Graph** button in the window toolbar.

## RESULTS

### *1D Plot Group 6*

- 1 In the **Model Builder** window, click **ID Plot Group 6**.
- 2 In the **Settings** window for **ID Plot Group**, locate the **Plot Settings** section.
- 3 Select the **x-axis label** checkbox. In the associated text field, type Position of counter electrode, d14 (m).
- 4 Select the **y-axis label** checkbox. In the associated text field, type Electric resistance (ohm).
- 5 Click  **Plot**.

You should see a plot similar to the plot in [Figure 4](#).

### *3D Plot Group 7*

- 1 In the **Model Builder** window, right-click **Results** and choose **3D Plot Group**.
- 2 In the **Settings** window for **3D Plot Group**, locate the **Data** section.
- 3 From the **Dataset** list, choose **Study 1/Parametric Solutions 1 (sol2)**.
- 4 From the **Parameter value (LL\_d14 (m))** list, choose **0.0105**.

### *Surface 1*

Right-click **3D Plot Group 7** and choose **Surface**.

### *Selection 1*

- 1 In the **Model Builder** window, right-click **Surface 1** and choose **Selection**.

- 2 In the **Settings** window for **Selection**, locate the **Selection** section.
- 3 From the **Selection** list, choose **Pacemaker**.

*Streamline 1*

- 1 In the **Model Builder** window, right-click **3D Plot Group 7** and choose **Streamline**.
- 2 In the **Settings** window for **Streamline**, locate the **Streamline Positioning** section.
- 3 From the **Positioning** list, choose **Starting-point controlled**.
- 4 Locate the **Coloring and Style** section. Find the **Point style** subsection. From the **Color** list, choose **Blue**.
- 5 Click  **Plot**.

The plot should now look similar to the one displayed below.

LL\_d14(3)=0.0105 m    Surface: Electric potential (V)    Streamline: Current density

