



Model created in COMSOL Multiphysics 6.4

Thermo-Photo-Voltaic Cell

Introduction

The following example illustrates an application that maximizes surface-to-surface radiative fluxes and minimizes conductive heat fluxes.

A thermo-photo-voltaic (TPV) cell generates electricity from the combustion of fuel and through radiation. [Figure 1](#) depicts the general operating principle. The fuel burns inside an emitting device that radiates intensely. Photovoltaic (PV) cells — almost like solar cells — capture the radiation and convert it to electricity. The efficiency of a TPV device ranges from 1% to 20%. In some cases, TPVs are used in heat generators to co-generate electricity, and the efficiency is not so critical. In other cases TPVs are used as electric power sources, for example in automobiles ([Ref. 1](#)). In those cases efficiency is a major concern.

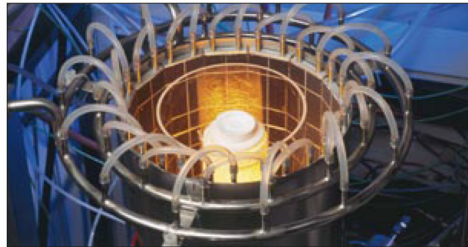
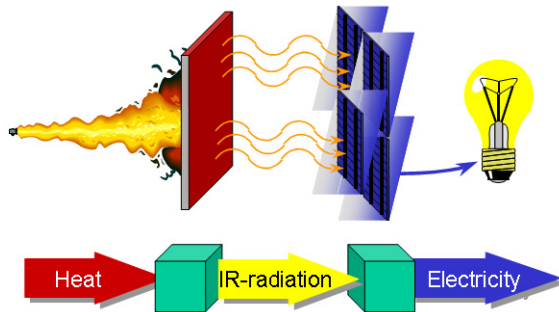

Figure 1: Operating principle of a TPV device ([Ref. 2](#)), and an image of a prototype system ([Ref. 3](#)).

TPV systems, unlike typical electronic systems, must maximize radiation heat transfer to improve efficiency. However, inherent radiation losses — radiation not converted to electric power — contributes to the PV cells' increased temperature. Further, heat transfer through conduction results in increased cell temperature. PV cells have a limited operating

temperature range that depends on the type of material used. Solar cells are limited to temperatures below 80°C, whereas high-efficiency semiconductor materials can withstand as much as 1000°C. Photovoltaic efficiency is often a function of temperature with a maximum at some temperature above ambient.

To improve system efficiency, engineers prefer to use high-efficiency PV cells, which however can be quite expensive. To reduce system costs, engineers work with smaller-area PV cells and then use mirrors to focus the radiation on them. However, there is a limit for how much you can focus the beams; if the radiation intensity becomes too high, the cells can overheat. Thus engineers must optimize system geometry and operating conditions to achieve maximum performance at minimum material costs.

The following application, which uses the Heat Transfer with Surface-to-Surface Radiation interface, investigates the influence of operating conditions (flame temperature) on system efficiency and the temperature of components in a typical TPV system. The application can also assess the influence of geometry changes.

Model Definition

Figure 2 depicts the geometry and dimensions of the system under study. To reduce the temperature, the PV cells are water cooled on their back side (at the interface with the insulation).

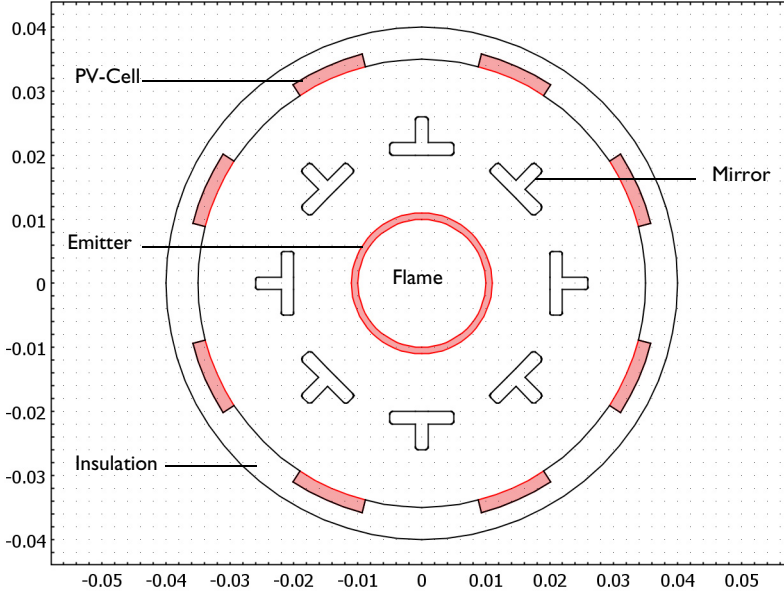

Figure 2: Geometry and dimensions of the modeled TPV system.

Conduction is always present on the different boundaries. The model simulates the emitter with a specific temperature, T_{heater} , on the inner boundary. At the outer emitter boundary, it takes radiation (surface-to-surface) into account in the boundary condition. It simulates the mirrors by taking radiation into account on all boundaries and applying a low emissivity. The inner boundaries of the PV cells and of the insulation also make use of radiation boundary conditions. However, the PV cells have a high emissivity and the insulation a low emissivity. Further, the PV cells convert a fraction of the irradiation to electricity instead of heat. Heat sinks on their inner boundaries simulate this effect by accounting for a boundary heat source, q , defined by

$$q = -G\eta_{\text{pv}}$$

where G is the irradiation flux (W/m^2) and η_{pv} is the PV cell's voltaic efficiency. The latter depends on the local temperature, with a maximum of 0.2 at 800 K:

$$\eta_{pv} = \begin{cases} 0.2 \left[1 - \left(\frac{T}{800 \text{ K}} - 1 \right)^2 \right] & T \leq 1600 \text{ K} \\ 0 & T > 1600 \text{ K} \end{cases}$$

Figure 3 illustrates this expression for temperatures above 1000 K.

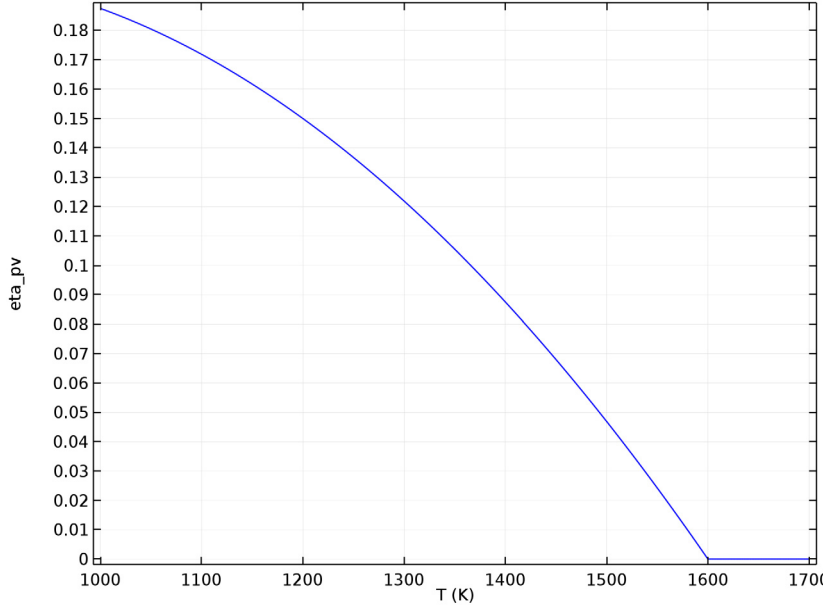

Figure 3: PV cell voltaic efficiency versus temperature.

At the outer boundary of the PV cells, the model applies convective water cooling by setting h to $50 \text{ W}/(\text{m}^2 \cdot \text{K})$, and T_{amb} to 273.15 K . Finally, at the outer boundary of the insulation it applies convective cooling with h set to $5 \text{ W}/(\text{m}^2 \cdot \text{K})$ and T_{amb} to 293.15 K .

Table 1 summarizes the material properties.

TABLE I: MATERIAL PROPERTIES.

COMPONENT	h (W/(m·K))	ρ (kg/m ³)	C_p (J/(kg·K))	ϵ
Emitter	10	2000	900	0.99
Mirror	10	5000	840	0.01
PV Cell	93	2000	840	0.99
Insulation	0.05	700	100	0.1

The model calculates the stationary solution for a range of emitter temperatures (1000 K to 2000 K) using the parametric solver.

Finally, the geometry shown in [Figure 2](#) allows taking advantage of sector symmetry and reflection to reduce the computational cost. As shown in [Figure 4](#), the geometry can be divided in 8 sectors (delimited by blue lines), each containing a reflection plane (red line). The computational domain is thus reduced to one sixteenth of the geometry. Then, for surface-to-surface radiation modeling, the view factor computation on the reduced geometry takes into account the presence of all the surfaces of the full geometry.

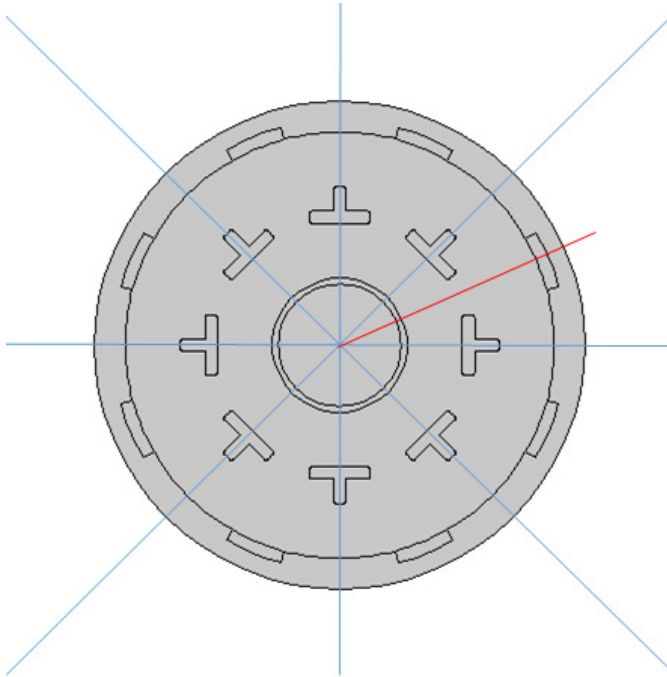

Figure 4: Sectors of symmetry (blue lines) and reflection plane (red line) in one sector.

Results and Discussion

The results shows that the device experiences a significant temperature distribution that varies with operating conditions. [Figure 5](#) depicts the stationary distribution on full geometry at operating conditions with an emitter temperature of 2000 K.

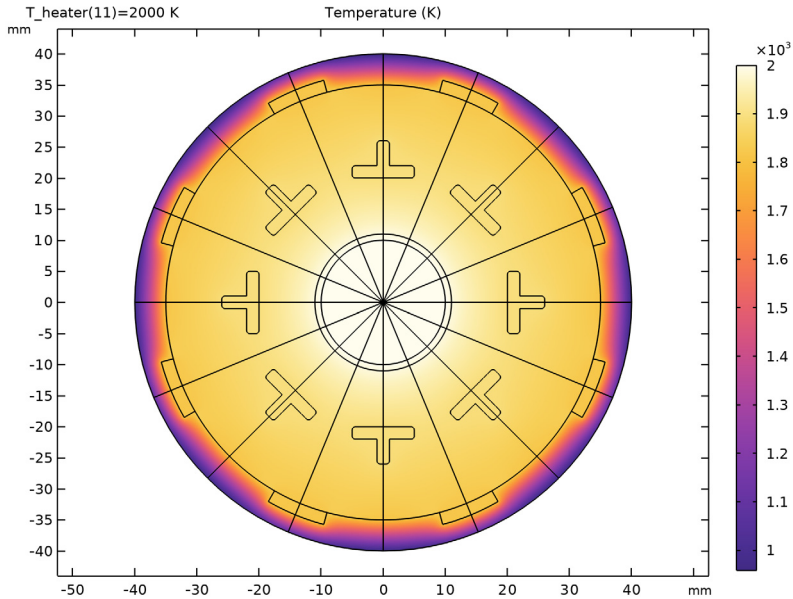

Figure 5: Temperature distribution in the TPV system when the emitter temperature is 2000 K.

As the upper plot in [Figure 6](#) shows, the PV cells reach a temperature of approximately 1800 K. This is significantly higher than their maximum operating temperature of 1600 K, above which their photovoltaic efficiency is zero (see [Figure 3](#)).

It is interesting to investigate what the optimal operating temperature is. The lower plot in [Figure 6](#) investigates at what temperature the system achieves the maximum electric power output. The optimal emitter temperature for this configuration seems to be

between 1600 K and 1700 K, where the electric power (irradiation multiplied by voltaic efficiency) is maximum.

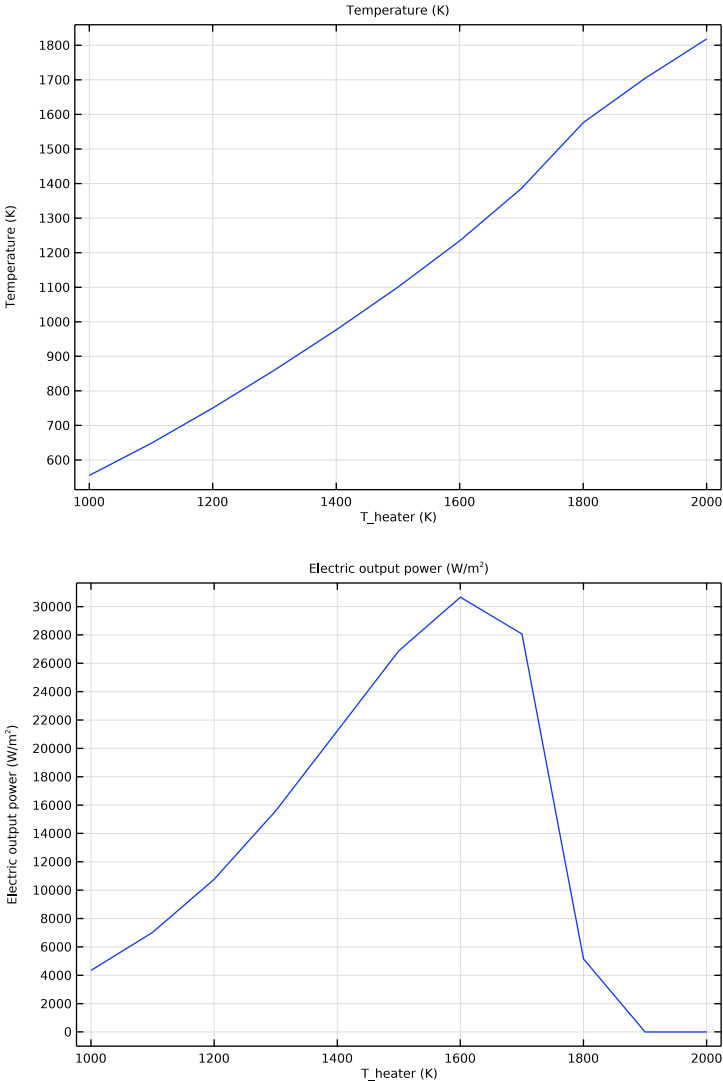

Figure 6: PV cell temperature (top) and electric output power (bottom) versus operating temperature.

The next step is to look at the temperature distribution at the optimal operating conditions (Figure 7).

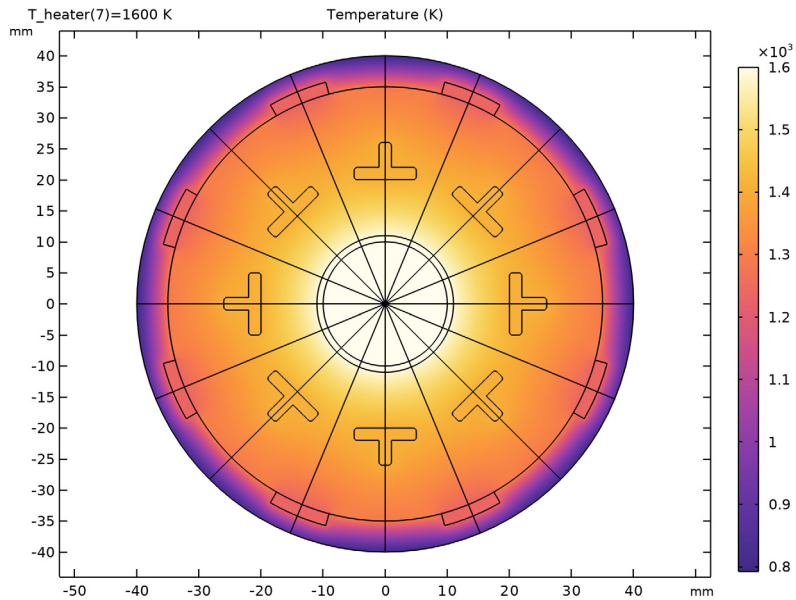

Figure 7: Temperature distribution and surface irradiation flux in the system at an operating emitter temperature of 1600 K.

When the emitter is at 1600 K, the PV cells reach a temperature of approximately 1200 K, which they can withstand without any problems. Note that the insulation reaches a temperature of approximately 800 K on the outside, suggesting that the system transfers a significant amount of heat to the surrounding air.

The irradiative flux varies significantly along the circumference of the PV cell and insulation jacket. To further investigate this effect, Figure 8 plots the irradiative flux at this operating condition in one sector of symmetry. Clearly the variation it shows is related to the positions of the mirrors and is an effect of shadowing.

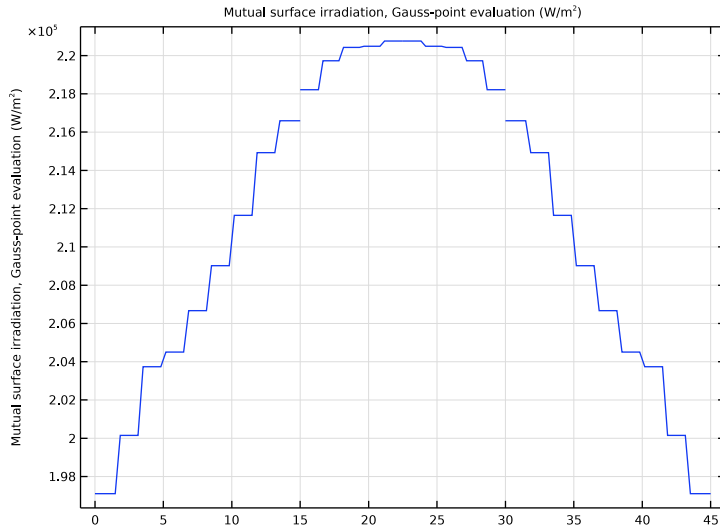

Figure 8: Irradiation flux along the TPV cells, insulation inner surface at an operating emitter temperature of 1600 K.

This plot can help optimize the mirror geometry as well as help decide how large the PV cells should be and where they should be placed.

A general conclusion is that this type of modeling can shortcut the prototype development time and optimize the operating conditions for the finalized TPV device.

References

1. S. Christ and M. Seal, “*Viking 27 — A Thermophotovoltaic Hybrid Vehicle Designed and Built at Western Washington University*”, SAE Technical Paper 972650, 1997.
2. Courtesy of E. Fontes, Catella Generics AB, Sweden.
3. Courtesy of Dr. D. Wilhelm, Paul Sherrer Institute, Switzerland.

Application Library path: Heat_Transfer_Module/Thermal_Radiation/tpv_cell



Modeling Instructions

From the **File** menu, choose **New**.

NEW

In the **New** window, click  **Model Wizard**.

MODEL WIZARD

- 1 In the **Model Wizard** window, click  **2D**.
- 2 In the **Select Physics** tree, select **Heat Transfer > Radiation > Heat Transfer with Surface-to-Surface Radiation**.
- 3 Click **Add**.
- 4 Click  **Study**.
- 5 In the **Select Study** tree, select **General Studies > Stationary**.
- 6 Click  **Done**.

GLOBAL DEFINITIONS

Parameters 1

- 1 In the **Model Builder** window, under **Global Definitions** click **Parameters 1**.
- 2 In the **Settings** window for **Parameters**, locate the **Parameters** section.
- 3 In the table, enter the following settings:

Name	Expression	Value	Description
T_heater	1000[K]	1000 K	Temperature, emitter inner boundary

GEOMETRY 1

- 1 In the **Model Builder** window, under **Component 1 (comp1)** click **Geometry 1**.
- 2 In the **Settings** window for **Geometry**, locate the **Units** section.
- 3 From the **Length unit** list, choose **mm**.

Circle 1 (c1)

- 1 In the **Geometry** toolbar, click  **Circle**.
- 2 In the **Settings** window for **Circle**, locate the **Size and Shape** section.
- 3 In the **Radius** text field, type 40.
- 4 In the **Sector angle** text field, type 360/16.

5 Click to expand the **Layers** section. In the table, enter the following settings:

Layer name	Thickness (mm)
Layer 1	5
Layer 2	24
Layer 3	1

6 Click  **Build Selected**.

Rectangle 1 (r1)

- 1 In the **Geometry** toolbar, click  **Rectangle**.
- 2 In the **Settings** window for **Rectangle**, locate the **Size and Shape** section.
- 3 In the **Width** text field, type 2.
- 4 In the **Height** text field, type 5.
- 5 Locate the **Position** section. In the **x** text field, type 20.



6 Click  **Build Selected**.

Rectangle 2 (r2)

- 1 In the **Geometry** toolbar, click  **Rectangle**.
- 2 In the **Settings** window for **Rectangle**, locate the **Size and Shape** section.
- 3 In the **Width** text field, type 6.
- 4 Locate the **Position** section. In the **x** text field, type 20.

5 Click  **Build Selected**.

Union 1 (un1)

- 1 In the **Geometry** toolbar, click  **Booleans and Partitions** and choose **Union**.
- 2 Select the objects **r1** and **r2** only.
- 3 In the **Settings** window for **Union**, locate the **Union** section.
- 4 Clear the **Keep interior boundaries** checkbox.
- 5 Click  **Build Selected**.

Fillet 1 (fil1)

- 1 In the **Geometry** toolbar, click  **Fillet**.

2 On the object **unil**, select Points 3, 6, and 8 only.

It might be easier to select the correct points by using the **Selection List** window. To open this window, in the **Home** toolbar click **Windows** and choose **Selection List**. (If you are running the cross-platform desktop, you find **Windows** in the main menu.)

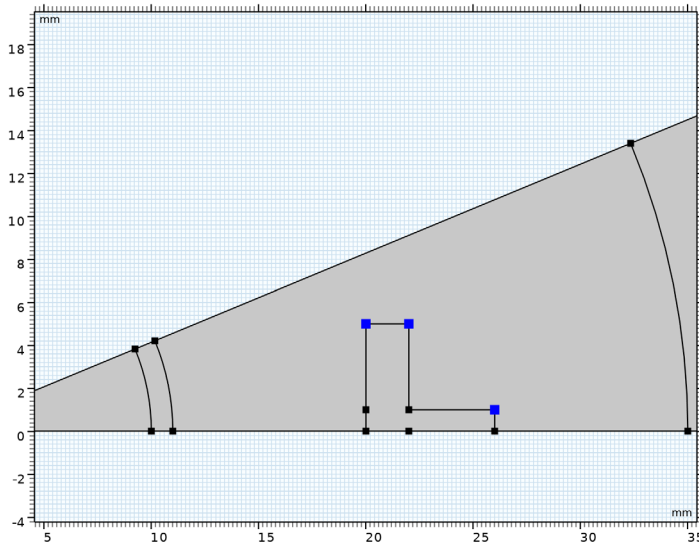

3 In the **Settings** window for **Fillet**, locate the **Radius** section.

4 In the **Radius** text field, type 0.5.

5 Click  **Build Selected**.

Circle 2 (c2)

1 In the **Geometry** toolbar, click  **Circle**.

2 In the **Settings** window for **Circle**, locate the **Size and Shape** section.

3 In the **Radius** text field, type 37.

4 In the **Sector angle** text field, type 360/48.



5 Locate the **Rotation Angle** section. In the **Rotation** text field, type 360/24.

6 Locate the **Layers** section. In the table, enter the following settings:

Layer name	Thickness (mm)
Layer 1	2

7 Click  **Build Selected**.

Delete Entities 1 (del1)

- 1 In the **Model Builder** window, right-click **Geometry 1** and choose **Delete Entities**.
- 2 In the **Settings** window for **Delete Entities**, locate the **Entities or Objects to Delete** section.
- 3 From the **Geometric entity level** list, choose **Domain**.
- 4 On the object **c2**, select Domain 1 only.
- 5 In the **Geometry** toolbar, click  **Build All**.
- 6 Click the  **Zoom Extents** button in the **Graphics** toolbar.

The model geometry is now complete. It represents one sixteenth of the full geometry by taking advantage of the sector symmetry and reflection plane within each sector.

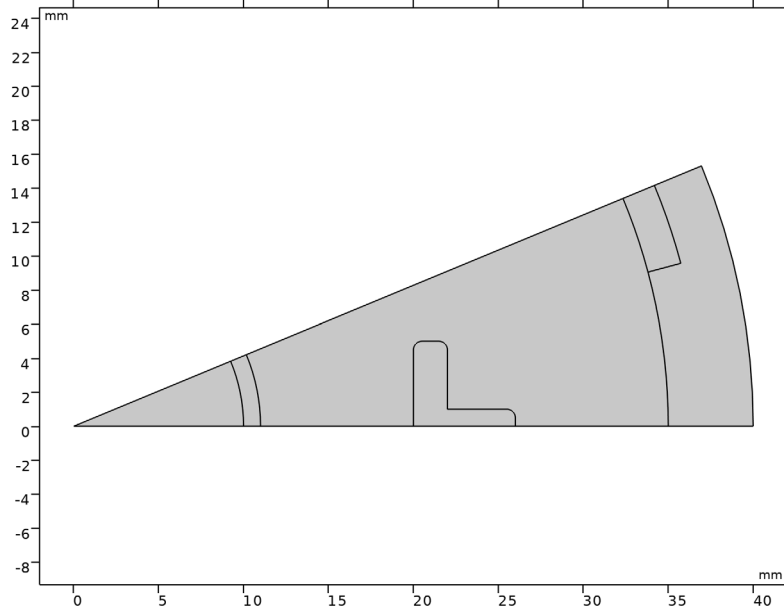

MATERIALS

Insulation

- 1 In the **Materials** toolbar, click  **Blank Material**.
- 2 In the **Settings** window for **Material**, type **Insulation** in the **Label** text field.

3 Locate the **Material Contents** section. In the table, enter the following settings:

Property	Variable	Value	Unit	Property group
Thermal conductivity	k_{iso} ; $k_{ii} = k_{iso}$, $k_{ij} = 0$	0.05 [W/(m·K)]	W/(m·K)	Basic
Density	ρ	700 [kg/m ³]	kg/m ³	Basic
Heat capacity at constant pressure	C_p	100 [J/(kg·K)]	J/(kg·K)	Basic

PV Cell

1 In the **Materials** toolbar, click  **Blank Material**.

2 In the **Settings** window for **Material**, type PV Cell in the **Label** text field.

3 Select Domain 5 only.

This is the PV-cell domain.

4 Locate the **Material Contents** section. In the table, enter the following settings:

Property	Variable	Value	Unit	Property group
Thermal conductivity	k_{iso} ; $k_{ii} = k_{iso}$, $k_{ij} = 0$	93 [W/(m·K)]	W/(m·K)	Basic
Density	ρ	2000 [kg/m ³]	kg/m ³	Basic
Heat capacity at constant pressure	C_p	840 [J/(kg·K)]	J/(kg·K)	Basic

Mirror

1 In the **Materials** toolbar, click  **Blank Material**.

2 In the **Settings** window for **Material**, type Mirror in the **Label** text field.

3 Select Domain 4 only.

4 Locate the **Material Contents** section. In the table, enter the following settings:

Property	Variable	Value	Unit	Property group
Thermal conductivity	k_{iso} ; $k_{ii} = k_{iso}$, $k_{ij} = 0$	10 [W/(m·K)]	W/(m·K)	Basic



Property	Variable	Value	Unit	Property group
Density	rho	5000 [kg / m ³]	kg/m ³	Basic
Heat capacity at constant pressure	Cp	840 [J / (kg * K)]	J/(kg·K)	Basic

Emitter

- 1 In the **Materials** toolbar, click  **Blank Material**.
- 2 In the **Settings** window for **Material**, type **Emitter** in the **Label** text field.
- 3 Select Domain 2 only.
- 4 Locate the **Material Contents** section. In the table, enter the following settings:

Property	Variable	Value	Unit	Property group
Thermal conductivity	k_iso ; kii = k_iso, kij = 0	10 [W / (m * K)]	W/(m·K)	Basic
Density	rho	2000 [kg / m ³]	kg/m ³	Basic
Heat capacity at constant pressure	Cp	900 [J / (kg * K)]	J/(kg·K)	Basic

ADD MATERIAL

- 1 In the **Materials** toolbar, click  **Add Material** to open the **Add Material** window.
- 2 Go to the **Add Material** window.
- 3 In the tree, select **Built-in > Air**.
- 4 Click the **Add to Component** button in the window toolbar.
- 5 In the **Materials** toolbar, click  **Add Material** to close the **Add Material** window.

MATERIALS

Air (mat5)

Select Domains 1 and 3 only.

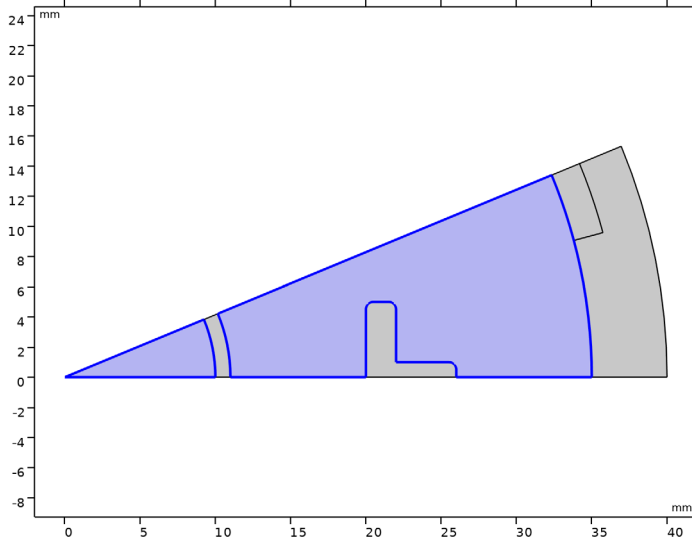

HEAT TRANSFER IN SOLIDS (HT)

Fluid 1

- 1 In the **Physics** toolbar, click  **Domains** and choose **Fluid**.
- 2 Select Domain 3 only.
- 3 In the **Settings** window for **Fluid**, locate the **Thermodynamics, Fluid** section.
- 4 From the **Fluid type** list, choose **Gas/Liquid**.
- 5 From the γ list, choose **User defined**.

Heat Flux 1

- 1 In the **Physics** toolbar, click  **Boundaries** and choose **Heat Flux**.
- 2 Select Boundary 28 only.

This is the outer boundary of the modeling domain, where convective air cooling is applied.
- 3 In the **Settings** window for **Heat Flux**, locate the **Heat Flux** section.
- 4 From the **Flux type** list, choose **Convective heat flux**.
- 5 In the h text field, type $5[\text{W}/(\text{m}^2\cdot\text{K})]$.

Boundary Heat Source 1

- 1 In the **Physics** toolbar, click  **Boundaries** and choose **Boundary Heat Source**.
- 2 Select Boundary 27 only.
These are the outward-facing PV-cell boundaries.
- 3 In the **Settings** window for **Boundary Heat Source**, locate the **Boundary Heat Source** section.
- 4 In the Q_b text field, type $50[\text{W}/(\text{m}^2\cdot\text{K})]*(273.15[\text{K}]-T)$.

Boundary Heat Source 2

- 1 In the **Physics** toolbar, click  **Boundaries** and choose **Boundary Heat Source**.
- 2 Select Boundary 25 only.
- 3 In the **Settings** window for **Boundary Heat Source**, locate the **Boundary Heat Source** section.
- 4 In the Q_b text field, type $-q_{\text{out}}$.

Temperature 1

- 1 In the **Physics** toolbar, click  **Boundaries** and choose **Temperature**.
- 2 Select Boundary 20 only.
This is the inward-facing emitter boundary.
- 3 In the **Settings** window for **Temperature**, locate the **Temperature** section.
- 4 In the T_0 text field, type T_{heater} .
Finally, apply a **Symmetry** boundary condition for the temperature.

Symmetry 1

- 1 In the **Physics** toolbar, click  **Boundaries** and choose **Symmetry**.
- 2 Select Boundaries 1–6, 8, 11, 15, 16, 18, and 19 only.

Surface-to-Ambient Radiation 1

- 1 In the **Physics** toolbar, click  **Boundaries** and choose **Surface-to-Ambient Radiation**.
- 2 Select Boundary 28 only.

SURFACE-TO-SURFACE RADIATION (RAD)

- 1 In the **Model Builder** window, under **Component 1 (comp1)** click **Surface-to-Surface Radiation (rad)**.
- 2 Select Boundaries 7, 9, 10, 12–14, and 21–26 only.

Diffuse Surface 1

By default, the radiation direction is controlled by the opacity of the domains. The solid parts are automatically defined as opaque while the fluid parts are transparent. You can change this setting using the **Opacity** feature in the **Surface-to-Surface Radiation** interface.

- 1 In the **Model Builder** window, under **Component 1 (comp1) > Surface-to-Surface Radiation (rad)** click **Diffuse Surface 1**.
- 2 In the **Settings** window for **Diffuse Surface**, locate the **Ambient** section.
- 3 In the T_{amb} text field, type T.

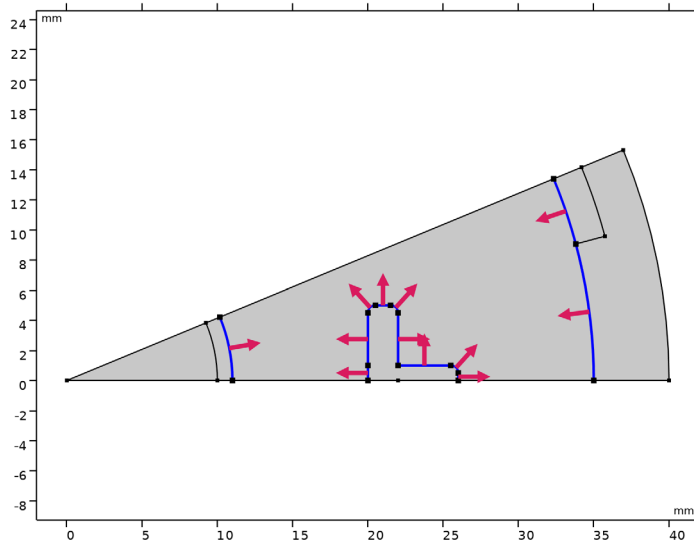

MATERIALS



Emitter boundary

- 1 In the **Model Builder** window, under **Component 1 (comp1)** right-click **Materials** and choose **Blank Material**.
- 2 In the **Settings** window for **Material**, locate the **Geometric Entity Selection** section.
- 3 From the **Geometric entity level** list, choose **Boundary**.
- 4 Select Boundary 21 only.
- 5 Locate the **Material Contents** section. In the table, enter the following settings:

Property	Variable	Value	Unit	Property group
Surface emissivity	epsilon_rad	0.99		Basic

6 In the **Label** text field, type Emitter boundary.

Mirror boundary

- 1 Right-click **Materials** and choose **Blank Material**.
- 2 Click the  **Select Box** button in the **Graphics** toolbar.
- 3 Select Domain 4 only.
- 4 In the **Settings** window for **Material**, locate the **Geometric Entity Selection** section.
- 5 From the **Geometric entity level** list, choose **Boundary**.
- 6 Click the  **Select Box** button in the **Graphics** toolbar.
- 7 Select Boundaries 7, 9, 10, 12–14, and 22–24 only.
- 8 Locate the **Material Contents** section. In the table, enter the following settings:

Property	Variable	Value	Unit	Property group
Surface emissivity	epsilon_rad	0.01		Basic

9 In the **Label** text field, type Mirror boundary.

Insulation boundary

- 1 Right-click **Materials** and choose **Blank Material**.
- 2 In the **Settings** window for **Material**, locate the **Geometric Entity Selection** section.
- 3 From the **Geometric entity level** list, choose **Boundary**.
- 4 Select Boundaries 26 and 28 only.
- 5 Locate the **Material Contents** section. In the table, enter the following settings:

Property	Variable	Value	Unit	Property group
Surface emissivity	epsilon_rad	0.1		Basic

6 In the **Label** text field, type Insulation boundary.

PV Cell boundary

- 1 Right-click **Materials** and choose **Blank Material**.
- 2 In the **Settings** window for **Material**, locate the **Geometric Entity Selection** section.
- 3 From the **Geometric entity level** list, choose **Boundary**.
- 4 Select Boundary 25 only.

5 Locate the **Material Contents** section. In the table, enter the following settings:

Property	Variable	Value	Unit	Property group
Surface emissivity	epsilon_rad	0.99	I	Basic

6 In the **Label** text field, type PV Cell boundary.

SURFACE-TO-SURFACE RADIATION (RAD)

Define the sectors of symmetry and reflection plane for the computation of view factor for surface-to-surface radiation.

Symmetry for Surface-to-Surface Radiation I

- 1 In the **Physics** toolbar, click  **Global** and choose **Symmetry for Surface-to-Surface Radiation**.
- 2 In the **Settings** window for **Symmetry for Surface-to-Surface Radiation**, locate the **Symmetry for Surface-to-Surface Radiation** section.
- 3 From the **Type of symmetry** list, choose **Sector symmetry**.
- 4 Locate the **Sector Symmetry** section. In the **Number of sectors** text field, type 8.
- 5 Locate the **Additional Reflection Plane** section. Select the **Reflection for symmetrical sector** checkbox.
- 6 Specify the **u** vector as

$\cos(\pi/8)$	x
$\sin(\pi/8)$	y

DEFINITIONS

Variables I

- 1 In the **Definitions** toolbar, click  **Local Variables**.
- 2 In the **Settings** window for **Variables**, locate the **Variables** section.
- 3 In the table, enter the following settings:

Name	Expression	Unit	Description
eta_pv	$\text{if}(T < 1600[\text{K}], 0.2 * (1 - (T/800[\text{K}] - 1)^2), 0)$		Voltaic efficiency, PV cell
q_out	rad.Gm*eta_pv	W/m ²	Electric output power

MESH I

- 1 In the **Model Builder** window, under **Component 1 (comp1)** click **Mesh 1**.

- 2 In the **Settings** window for **Mesh**, locate the **Physics-Controlled Mesh** section.
- 3 From the **Element size** list, choose **Coarser**.

Free Triangular I

In the **Mesh** toolbar, click  **Free Triangular**.

Size I

- I Right-click **Free Triangular I** and choose **Size**.
- 2 In the **Settings** window for **Size**, locate the **Geometric Entity Selection** section.
- 3 From the **Geometric entity level** list, choose **Boundary**.
- 4 Select Boundaries 7, 9, 10, 12–14, and 21–26 only.
- 5 Locate the **Element Size** section. Click the **Custom** button.
- 6 Locate the **Element Size Parameters** section. Select the **Maximum element size** checkbox.
- 7 Select the **Minimum element size** checkbox.
- 8 Select the **Maximum element growth rate** checkbox.
- 9 Select the **Curvature factor** checkbox.
- 10 In the **Maximum element size** text field, type 1.
- 11 Click  **Build All**.

STUDY I

Step I: Stationary

Set up an auxiliary continuation sweep for the parameter T_heater.

- 1 In the **Model Builder** window, under **Study I** click **Step I: Stationary**.
- 2 In the **Settings** window for **Stationary**, click to expand the **Study Extensions** section.
- 3 Select the **Auxiliary sweep** checkbox.
- 4 Click  **Add**.
- 5 In the table, enter the following settings:

Parameter name	Parameter value list	Parameter unit
T_heater (Temperature, emitter inner boundary)		K

- 6 Click  **Range**.
- 7 In the **Range** dialog, type 1000 in the **Start** text field.
- 8 In the **Step** text field, type 100.

9 In the **Stop** text field, type 2000.

10 Click **Replace**.

11 In the **Study** toolbar, click  **Compute**.

RESULTS

Reconstruct the full geometry for a better visualization by defining a **Sector 2D** dataset. Then use it into the default plots.

Sector 2D I

1 In the **Results** toolbar, click  **More Datasets** and choose **Sector 2D**.

2 In the **Settings** window for **Sector 2D**, locate the **Symmetry** section.

3 In the **Number of sectors** text field, type 16.

4 From the **Transformation** list, choose **Rotation and reflection**.

5 Find the **Direction of reflection axis** subsection. In the **X** text field, type $\cos(\pi/8)$.

6 In the **Y** text field, type $\sin(\pi/8)$.

7 Click  **Plot**.

Temperature (ht)

1 In the **Model Builder** window, expand the **Results > Temperature (ht)** node, then click **Temperature (ht)**.

2 In the **Settings** window for **2D Plot Group**, locate the **Data** section.

3 From the **Dataset** list, choose **Sector 2D I**.

4 In the **Temperature (ht)** toolbar, click  **Plot**.

Surface Radiosity (rad)

1 In the **Model Builder** window, click **Surface Radiosity (rad)**.

2 In the **Settings** window for **2D Plot Group**, locate the **Data** section.

3 From the **Dataset** list, choose **Sector 2D I**.

4 In the **Surface Radiosity (rad)** toolbar, click  **Plot**.

Temperature (ht)

1 Click the  **Zoom Extents** button in the **Graphics** toolbar.

The first default surface plot shows the TPV-cell temperature for the last value in the sweep over operating temperatures.

Surface Radiosity (rad)



The second default plot shows radiosity.

Reproduce the plots in [Figure 6](#) with the following steps:

PV Cell Temperature

- 1 In the **Results** toolbar, click  **ID Plot Group**.
- 2 In the **Settings** window for **ID Plot Group**, type PV Cell Temperature in the **Label** text field.



Point Graph 1

- 1 In the **PV Cell Temperature** toolbar, click  **Point Graph**.
- 2 Select Point 18 only.
- 3 In the **PV Cell Temperature** toolbar, click  **Plot**.

Electric Output Power

- 1 In the **Results** toolbar, click  **ID Plot Group**.
- 2 In the **Settings** window for **ID Plot Group**, type Electric Output Power in the **Label** text field.

Point Graph 1

- 1 In the **Electric Output Power** toolbar, click  **Point Graph**.
- 2 Select Point 18 only.
- 3 In the **Settings** window for **Point Graph**, click **Replace Expression** in the upper-right corner of the **y-Axis Data** section. From the menu, choose **Component 1 (comp1) > Definitions > Variables > q_out - Electric output power - W/m²**.
- 4 In the **Electric Output Power** toolbar, click  **Plot**.

As this last plot shows, the electric output power has a maximum near 1600 K. To see the temperature distribution at this operating temperature, go back to the first plot group and change the parameter value.

Temperature (ht)

- 1 In the **Model Builder** window, under **Results** click **Temperature (ht)**.
- 2 In the **Settings** window for **2D Plot Group**, locate the **Data** section.
- 3 From the **Parameter value (T_heater (K))** list, choose **1600**.
- 4 In the **Temperature (ht)** toolbar, click  **Plot**.

Finally, reproduce the surface irradiation plot in [Figure 8](#) as follows:

Mutual Surface Irradiation

- 1 In the **Results** toolbar, click  **ID Plot Group**.

- 2 In the **Settings** window for **ID Plot Group**, type Mutual Surface Irradiation in the **Label** text field.
- 3 Locate the **Data** section. From the **Parameter selection (T_heater)** list, choose **From list**.
- 4 In the **Parameter values (T_heater (K))** list box, select **1600**.

Line Graph 1

- 1 Right-click **Mutual Surface Irradiation** and choose **Line Graph**.
- 2 Select Boundaries 25 and 26 only.
- 3 In the **Settings** window for **Line Graph**, click **Replace Expression** in the upper-right corner of the **y-Axis Data** section. From the menu, choose **Component 1 (comp1) > Surface-to-Surface Radiation > Irradiation > rad.Gm_gp - Mutual surface irradiation, Gauss-point evaluation - W/m²**.
- 4 Locate the **x-Axis Data** section. From the **Parameter** list, choose **Expression**.
- 5 In the **Expression** text field, type $\text{atan2}(y, x) * 180 / \pi$.

Line Graph 2

- 1 Right-click **Line Graph 1** and choose **Duplicate**.
- 2 In the **Settings** window for **Line Graph**, locate the **x-Axis Data** section.
- 3 In the **Expression** text field, type $360 / 8 - \text{atan2}(y, x) * 180 / \pi$.
- 4 Click to expand the **Title** section. From the **Title type** list, choose **None**.
- 5 Click to expand the **Coloring and Style** section. From the **Color** list, choose **Cycle (reset)**.
- 6 In the **Mutual Surface Irradiation** toolbar, click  **Plot**.

This plot of the irradiative flux in one sector of symmetry shows the shadowing effect of the mirror (at each end of the x -axis).