



Model created in COMSOL Multiphysics 6.4

Thermal Bridges in Building Construction – 3D Iron Bar Through Insulation Layer

Introduction

The European standard EN ISO 10211:2017 for thermal bridges in building constructions provides four test cases — two 2D and two 3D — for validating a numerical method (Ref. 1). If the values obtained by a method conform to the results of all these four cases, the method is classified as a *three-dimensional steady-state high precision method*.

COMSOL Multiphysics successfully passes all the test cases described by the standard. This document presents an implementation of the second 3D model (Case 4).

This tutorial studies the heat conduction in a thermal bridge made up of an iron bar and an insulation layer that separates a hot internal side from a cold external side. The iron bar is embedded in the insulation layer as shown in Figure 1. After solving the model, the heat flux between the internal and external sides and the maximum temperature on the external wall are calculated, and the results are compared to the expected values.

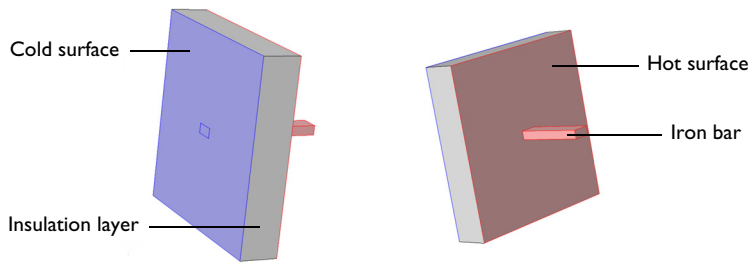

Figure 1: Back side (left) and front side (right) views of the iron bar embedded in an insulation layer, ISO 10211:2017 test case 4. Colored regions correspond to internal and external boundaries.

Model Definition

The geometry is illustrated above in Figure 1. The square insulation layer, with a low thermal conductivity k of $0.1 \text{ W}/(\text{m}\cdot\text{K})$, has a cold and a hot surface. The iron bar has a higher thermal conductivity, $50 \text{ W}/(\text{m}\cdot\text{K})$. Its boundaries are mainly located in the hot environment but one of them reaches the cold side.

Cold and hot surfaces are subject to convective heat flux. The ISO 10211:2017 standard specifies the values of the thermal resistance, R , which is related to the heat transfer coefficient, h , according to

$$h = \frac{1}{R}$$

Notes About the COMSOL Implementation

Compared to the rest of the structure, the dimensions of the intersection between the iron bar and the insulation layer are relatively small but the temperature gradients are large. Therefore, the element size is reduced in this area to give sufficient accuracy. To save computational time, this refinement is not applied on the remaining mesh.

Results and Discussion

In [Figure 2](#), the temperature profile shows the effects of the thermal bridge where the heat variations are most pronounced.

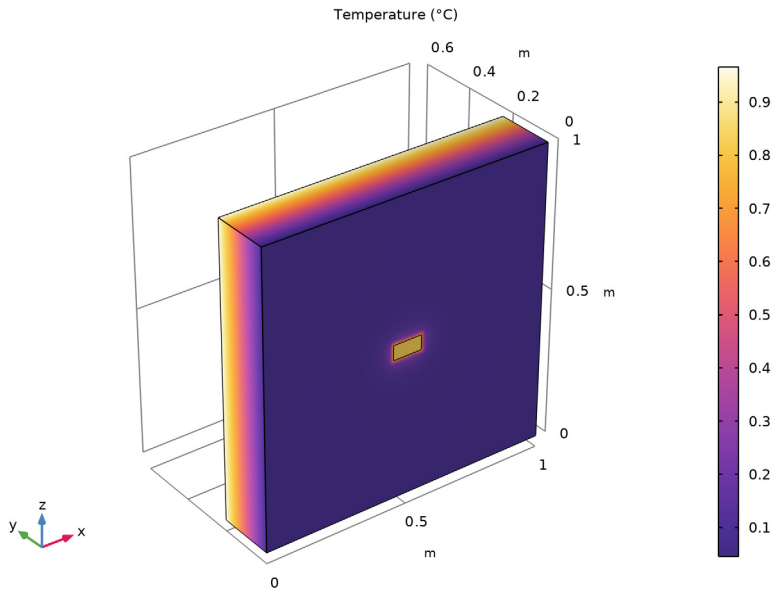

Figure 2: Temperature distribution of ISO 10211:2017 test case 4.

Table 1 compares the numerical results of COMSOL Multiphysics with the expected values provided by EN ISO 10211:2017 (Ref. 1).

TABLE 1: COMPARISON BETWEEN EXPECTED VALUES AND COMPUTED VALUES.

MEASURED QUANTITY	EXPECTED VALUE	COMPUTED VALUE	DIFFERENCE
Highest temperature on external side	0.805°C	0.801°C	$4 \cdot 10^{-3}$ °C
Heat flux	0.540 W	0.542 W	0.37%

The maximum permissible differences to pass this test case are $5 \cdot 10^{-3}$ °C for temperature and 1% for heat flux. The measured values are completely coherent and meet the validation criteria.

Reference

1. European Committee for Standardization, *EN ISO 10211, Thermal bridges in building construction – Heat flows and surface temperatures – Detailed calculations (ISO 10211:2017)*, Appendix A, pp. 54–60, 2017.

Application Library path: Heat_Transfer_Module/
Buildings_and_Constructions/thermal_bridge_3d_iron_bar



Modeling Instructions

From the **File** menu, choose **New**.

NEW

In the **New** window, click  **Model Wizard**.

MODEL WIZARD

- 1 In the **Model Wizard** window, click  **3D**.
- 2 In the **Select Physics** tree, select **Heat Transfer > Heat Transfer in Solids (ht)**.
- 3 Click **Add**.
- 4 Click  **Study**.
- 5 In the **Select Study** tree, select **General Studies > Stationary**.
- 6 Click  **Done**.

GLOBAL DEFINITIONS

Define the geometrical parameters.



Parameters 1

- 1 In the **Model Builder** window, under **Global Definitions** click **Parameters 1**.
- 2 In the **Settings** window for **Parameters**, locate the **Parameters** section.
- 3 In the table, enter the following settings:

Name	Expression	Value	Description
w1	1[m]	1 m	Insulation layer width
d1	0.2[m]	0.2 m	Insulation layer depth
h1	1[m]	1 m	Insulation layer height
w2	0.1[m]	0.1 m	Iron bar width
d2	0.6[m]	0.6 m	Iron bar depth
h2	50[mm]	0.05 m	Iron bar height

GEOMETRY 1

Block 1 (blk1)

- 1 In the **Geometry** toolbar, click  **Block**.
- 2 In the **Settings** window for **Block**, locate the **Size and Shape** section.
- 3 In the **Width** text field, type w1.
- 4 In the **Depth** text field, type d1.
- 5 In the **Height** text field, type h1.
- 6 Click  **Build Selected**.

Create the iron bar at the center of the insulation layer.

Block 2 (blk2)

- 1 In the **Geometry** toolbar, click  **Block**.
- 2 In the **Settings** window for **Block**, locate the **Size and Shape** section.
- 3 In the **Width** text field, type w2.
- 4 In the **Depth** text field, type d2.
- 5 In the **Height** text field, type h2.
- 6 Locate the **Position** section. In the **x** text field, type $w1/2-w2/2$.
- 7 In the **z** text field, type $h1/2-h2/2$.

8 Click  **Build Selected**.

9 Click the  **Wireframe Rendering** button in the **Graphics** toolbar to get a better view of the interior parts.

To remove the unnecessary interior boundary in the iron bar, proceed as follows.

Ignore Faces 1 (igfl)

1 In the **Geometry** toolbar, click  **Virtual Operations** and choose **Ignore Faces**.

2 On the object **fin**, select Boundary 11 only.

Note that you can create the selection by clicking the **Paste Selection** button and typing the indices in the dialog that opens.

3 In the **Geometry** toolbar, click  **Build All**.

4 Click the  **Zoom Extents** button in the **Graphics** toolbar.

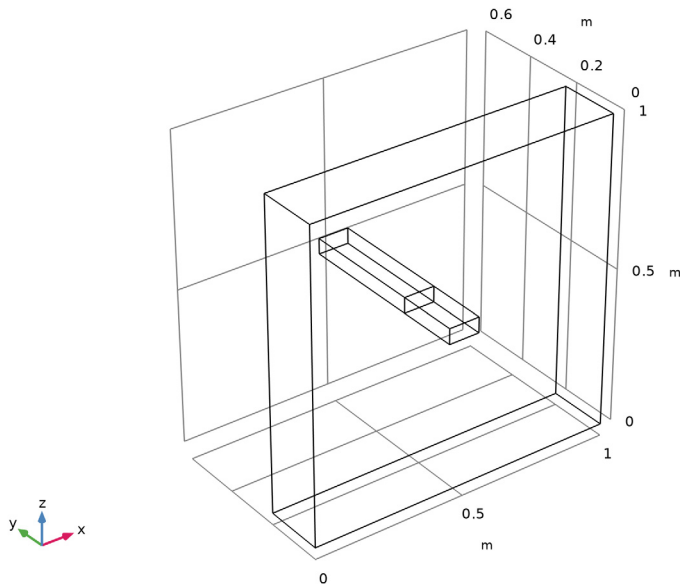

DEFINITIONS

Create a set of selections for use when setting up the physics. First, select the boundaries inside the region $y \geq 0.1$.



Internal

1 In the **Definitions** toolbar, click  **Box**.

- 2 In the **Settings** window for **Box**, type Internal in the **Label** text field.
- 3 Locate the **Geometric Entity Level** section. From the **Level** list, choose **Boundary**.
- 4 Locate the **Box Limits** section. In the **y minimum** text field, type 0.1.
- 5 Locate the **Output Entities** section. From the **Include entity if** list, choose **Entity inside box**.

Next, select all the boundaries inside the region $y \leq 0.1$.

External

- 1 In the **Definitions** toolbar, click  **Box**.
- 2 In the **Settings** window for **Box**, type External in the **Label** text field.
- 3 Locate the **Geometric Entity Level** section. From the **Level** list, choose **Boundary**.
- 4 Locate the **Box Limits** section. In the **y maximum** text field, type 0.1.
- 5 Locate the **Output Entities** section. From the **Include entity if** list, choose **Entity inside box**.
- 6 Click the  **Wireframe Rendering** button in the **Graphics** toolbar.

MATERIALS

Insulation

- 1 In the **Materials** toolbar, click  **Blank Material**.
- 2 In the **Settings** window for **Material**, type Insulation in the **Label** text field.
- 3 Select Domain 1 only.
- 4 Locate the **Material Contents** section. In the table, enter the following settings:

Property	Variable	Value	Unit	Property group
Thermal conductivity	$k_{iso} ; k_{ij} = k_{iso}, k_{ij} = 0$	0.1 [W/(m·K)]	W/(m·K)	Basic
Density	rho	500 [kg/m ³]	kg/m ³	Basic
Heat capacity at constant pressure	Cp	1700 [J/(kg·K)]	J/(kg·K)	Basic

Iron

- 1 In the **Materials** toolbar, click  **Blank Material**.
- 2 In the **Settings** window for **Material**, type Iron in the **Label** text field.
- 3 Select Domain 2 only.

4 Locate the **Material Contents** section. In the table, enter the following settings:

Property	Variable	Value	Unit	Property group
Thermal conductivity	k_{iso} ; $k_{ij} = k_{iso}$, $k_{ij} = 0$	50 [W/ (m* K)]	W/(m·K)	Basic
Density	ρ	7800 [kg/ m ³]	kg/m ³	Basic
Heat capacity at constant pressure	C_p	460 [J/ (kg*K)]	J/(kg·K)	Basic

HEAT TRANSFER IN SOLIDS (HT)

Heat Flux 1

- 1 In the **Physics** toolbar, click  **Boundaries** and choose **Heat Flux**.
- 2 In the **Settings** window for **Heat Flux**, locate the **Boundary Selection** section.
- 3 From the **Selection** list, choose **Internal**.
- 4 Locate the **Heat Flux** section. From the **Flux type** list, choose **Convective heat flux**.
- 5 In the h text field, type 1 [W/ (m²*K)]/0.10.
- 6 In the T_{ext} text field, type 1 [degC].

Heat Flux 2

- 1 In the **Physics** toolbar, click  **Boundaries** and choose **Heat Flux**.
- 2 In the **Settings** window for **Heat Flux**, locate the **Boundary Selection** section.
- 3 From the **Selection** list, choose **External**.
- 4 Locate the **Heat Flux** section. From the **Flux type** list, choose **Convective heat flux**.
- 5 In the h text field, type 1 [W/ (m²*K)]/0.10.
- 6 In the T_{ext} text field, type 0 [degC].

MESH 1

Because the largest temperature variations are expected at the exterior boundary of the iron bar, refine the mesh in this region. Use the default settings in the remaining domains.

Free Tetrahedral 1

In the **Mesh** toolbar, click  **Free Tetrahedral**.

Size 1

- 1 In the **Mesh** toolbar, click **Size Attribute** and choose **Extremely Fine**.

- 2 In the **Settings** window for **Size**, locate the **Geometric Entity Selection** section.
- 3 From the **Geometric entity level** list, choose **Domain**.
- 4 Select Domain 2 only.
- 5 Click  **Build All**.



STUDY I

In the **Study** toolbar, click  **Compute**.

RESULTS

Change the unit of the temperature results to degrees Celsius.

Preferred Units I

- 1 In the **Results** toolbar, click  **Configurations** and choose **Preferred Units**.
- 2 In the **Settings** window for **Preferred Units**, locate the **Units** section.
- 3 Click  **Add Physical Quantity**.
- 4 In the **Physical Quantity** dialog, select **General > Temperature (K)** in the tree.
- 5 Click **OK**.
- 6 In the **Settings** window for **Preferred Units**, locate the **Units** section.
- 7 In the table, enter the following settings:

Quantity	Unit	Preferred unit
Temperature	K	°C

- 8 Click  **Apply**.

The default plot group shows the temperature distribution; compare with [Figure 2](#).

Follow the steps below to calculate the maximum temperature on the external surface and the heat flux between the internal and external sides. Compare the values with the expected results listed in [Table 1](#).

Surface Maximum I



- 1 In the **Results** toolbar, click  **More Derived Values** and choose **Maximum > Surface Maximum**.
- 2 In the **Settings** window for **Surface Maximum**, locate the **Selection** section.
- 3 From the **Selection** list, choose **External**.
- 4 Click  **Evaluate**.

TABLE 1

1 Go to the **Table 1** window.

The displayed value should be close to 0.805°C .

RESULTS

Surface Integration 1

- 1 In the **Results** toolbar, click 8.85×10^{-12} **More Derived Values** and choose **Integration > Surface Integration**.
- 2 In the **Settings** window for **Surface Integration**, locate the **Selection** section.
- 3 From the **Selection** list, choose **External**.
- 4 Click **Replace Expression** in the upper-right corner of the **Expressions** section. From the menu, choose **Component 1 (comp1) > Heat Transfer in Solids > Boundary fluxes > ht.q0 - Inward heat flux - W/m²**.
- 5 Click **Evaluate** .

TABLE 2

1 Go to the **Table 2** window.

The measured flux should be close to 0.540 W.