



Model created in COMSOL Multiphysics 6.4

Shell-and-Tube Heat Exchanger

Introduction

Shell-and-tube heat exchangers are one of the most widely used type of heat exchanger in the processing industries (65% of the market according to [Ref. 1](#)) and are commonly found in oil refineries, nuclear power plants, and other large-scale chemical processes.

Additionally, they can be found in many engines and are used to cool hydraulic fluid and oil. In this model, two separated fluids at different temperatures flow through the heat exchanger: one through the tubes (tube side) and the other through the shell around the tubes (shell side). Several design parameters and operating conditions influence the optimal performance of a shell-and-tube heat exchanger.

The main purpose of this tutorial is to show the basic principles for setting up a heat exchanger model. It can also serve as a starting point for more sophisticated applications, such as parameter studies or adding additional effects like corrosion, thermal stress, and vibration.

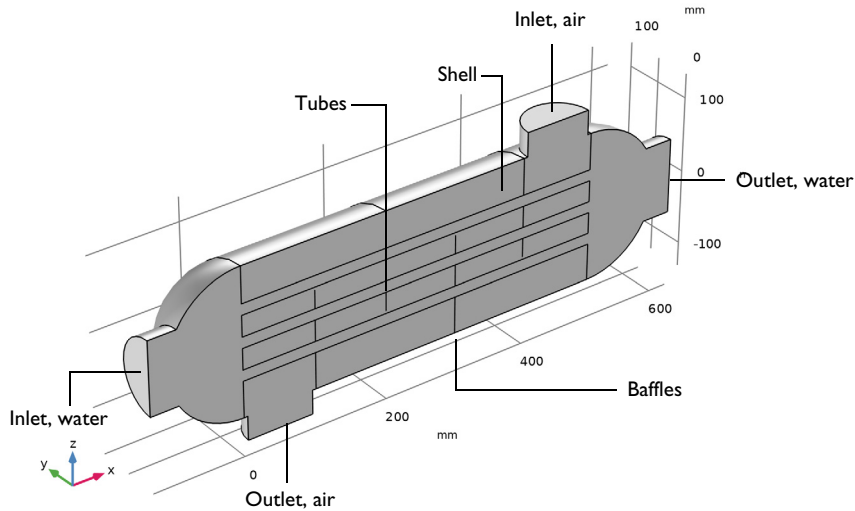

Figure 1: Geometry of the shell-and-tube heat exchanger.

Model Definition

The concept used to design a shell-and-tube heat exchanger is examined by exploring the working model of a straight, cross-flow, one pass shell-and-tube heat exchanger. The geometry of such a model is shown in [Figure 1](#).

The heat exchanger is made of structural steel. In this example, two fluids pass through the heat exchanger. The first fluid, in this case water, flows through the tubes, while the second fluid, air, circulates within the shell of the heat exchanger but outside of the tubes. Both of these fluids have different starting temperatures when entering the heat exchanger, however after circulating within it, the fluids are brought closer to an equilibrium temperature. The baffles introduce some cross-flow to the air leading to an increase in the area of heat exchange. Another advantage is that baffles reduce vibration due to the fluid motion.

This model uses the Nonisothermal Flow predefined multiphysics coupling configured with the k - ϵ turbulence model. It takes advantage of symmetries to model only one half of the heat exchanger, thereby reducing model size and computational costs.

BOUNDARY CONDITIONS

All heat exchanger walls including the baffles are modeled as shells in 3D. This requires special boundary conditions for the flow and heat transport equations.

The interior wall boundary condition for the flow separates the fluids from each other and is also used to describe the baffles. On both sides, it applies the wall functions needed for simulating walls with the k - ϵ turbulence model.

To account for the in-plane heat flux in the shell, the **Thin Layer** boundary condition is applied. This boundary condition simulates heat transfer in thin shell structures. Here, the shell is supposed to be made of steel with a 1 mm thickness.

Beside the symmetry plane, all remaining exterior boundaries are thermally insulated walls.

Results and Discussion

An important criterion for estimating the accuracy of a turbulence model is the wall resolution. Hence, COMSOL Multiphysics creates a plot of the wall resolution by default. The value for δ_w^+ has to be small enough so that wall functions give reasonable predictions. Furthermore, the wall lift-off δ_w has to be small compared to the dimension of the geometry. On interior walls you have δ_w for the upside and downside of the wall.

[Figure 2](#) shows the downside wall lift-off. This is the wall lift-off inside the tubes where the probably most critical area in terms of mesh resolution is located. It is about 0.5 mm

which is reasonably small compared to the tube radius, which is 7.5 mm. A finer mesh would lead to a lower wall lift-off value and hence to a better accuracy.

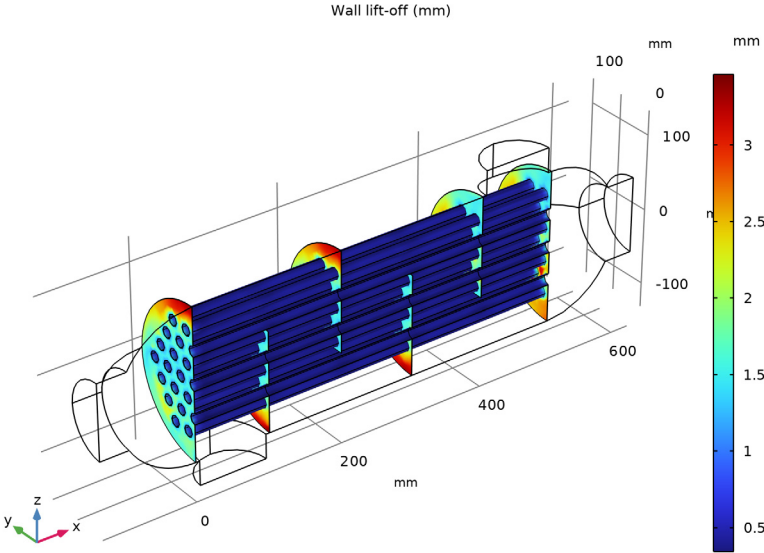

Figure 2: Wall lift-off for the tubes.

The tube side velocity shows a uniform distribution in the tubes. Before water enters the tubes, recirculation zones are present. The streamline colors represent the temperature and you can see that the temperatures at both outlets are close to each other.

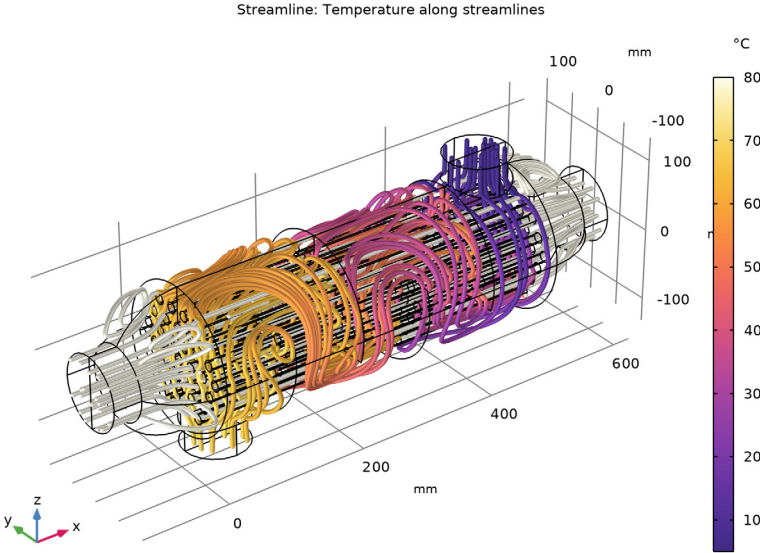

Figure 3: Velocity streamlines.

Figure 4 shows the temperature distribution on the heat exchanger boundaries.

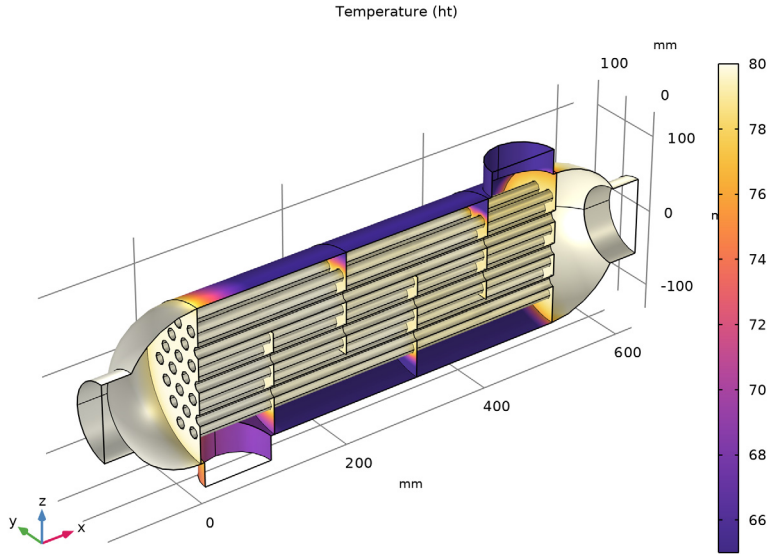

Figure 4: Temperature at the heat exchanger boundaries.

There are several quantities that describe the characteristics and effectiveness of a heat exchanger. One is the equivalent heat transfer coefficient given by

$$h_{\text{eq}} = \frac{P}{A(T_{\text{hot}} - T_{\text{cold}})} \quad (1)$$

where P is the total exchanged power and A is the surface area through which P flows. In this model the value of h_{eq} is $5.9 \text{ W}/(\text{m}^2 \cdot \text{K})$.

The pressure drop is slightly lower than 40 Pa on the tube side and about 13 Pa on the shell side.

Notes About the COMSOL Implementation

Solve the model using a physics-controlled mesh. For flow applications this means that COMSOL Multiphysics automatically generates a mesh sequence where the mesh size depends on whether the flow is laminar or turbulent and where a boundary layer mesh is applied to all no slip walls. Even if the coarsest mesh size is used, the mesh is still fine

enough to resolve the flow pattern and thus the temperature distribution well. Nevertheless, this model requires about 5 GB RAM. Alternatively, you can set up a coarser mesh manually, but keep in mind that this can lead to lower accuracy.

The first part of the modeling process is the preprocessing. This includes defining parameters, preparing the geometry, and defining relevant selections. You can skip this part by loading the file `shell_and_tube_heat_exchanger_geom.mph`. However, we recommend that you take a look at these steps at least once. Especially when developing models intended for optimization and sophisticated analyses, these steps can significantly simplify and accelerate the modeling process.

Defining parameters beforehand enables setting up a parametric study immediately, also for multiple parameter sets. In addition, this provides a fast overview of the operating conditions. In the [Modeling Instructions](#), several selections are also created. Once defined, they are available in every step of the modeling process. If you want to change from concurrent to countercurrent heat exchanger, you only need to redefine the selections.

Application Library path: Heat_Transfer_Module/Heat_Exchangers/
shell_and_tube_heat_exchanger

Reference

1. H. S. Lee, *Thermal Design*, John Wiley & Sons, 2010.



Modeling Instructions

From the **File** menu, choose **New**.

NEW

In the **New** window, click  **Model Wizard**.

MODEL WIZARD

- 1 In the **Model Wizard** window, click  **3D**.
- 2 In the **Select Physics** tree, select **Fluid Flow > Nonisothermal Flow > Turbulent Flow > Turbulent Flow, k-ε**.
- 3 Click **Add**.
- 4 Click  **Study**.

5 In the **Select Study** tree, select **General Studies > Stationary**.

6 Click  **Done**.

GEOMETRY I

The geometry sequence for the model is available in a file. If you want to create it from scratch yourself, you can follow the instructions in the [Geometry Modeling Instructions](#) section. Otherwise, insert the geometry sequence as follows:

1 In the **Geometry** toolbar, click **Insert Sequence** and choose **Insert Sequence**.

2 Browse to the model's Application Libraries folder and double-click the file `shell_and_tube_heat_exchanger_geom_sequence.mph`.

3 In the **Geometry** toolbar, click  **Build All**.

4 Click the  **Zoom Extents** button in the **Graphics** toolbar.

You should now see the geometry shown in [Figure 1](#).

5 Click the  **Wireframe Rendering** button in the **Graphics** toolbar.

GLOBAL DEFINITIONS

Parameters I

1 In the **Model Builder** window, under **Global Definitions** click **Parameters I**.

2 In the **Settings** window for **Parameters**, locate the **Parameters** section.

3 In the table, enter the following settings:

Name	Expression	Value	Description
u_water	0.1[m/s]	0.1 m/s	Inlet velocity, water
u_air	1[m/s]	1 m/s	Inlet velocity, air
T_water	80[degC]	353.15 K	Inlet temperature, water
T_air	5[degC]	278.15 K	Inlet temperature, air

ADD MATERIAL

1 In the **Home** toolbar, click  **Add Material** to open the **Add Material** window.

2 Go to the **Add Material** window.

3 In the tree, select **Built-in > Air**.

4 Click the **Add to Component** button in the window toolbar.

5 In the tree, select **Built-in > Water, liquid**.

6 Click the **Add to Component** button in the window toolbar.

- 7 In the tree, select **Built-in > Steel AISI 4340**.
- 8 Click the **Add to Component** button in the window toolbar.
- 9 In the **Home** toolbar, click  **Add Material** to close the **Add Material** window.

MATERIALS

Air (mat1)

- 1 In the **Settings** window for **Material**, locate the **Geometric Entity Selection** section.
- 2 From the **Selection** list, choose **Air Domain**.

Water, liquid (mat2)

- 1 In the **Model Builder** window, click **Water, liquid (mat2)**.
- 2 In the **Settings** window for **Material**, locate the **Geometric Entity Selection** section.
- 3 From the **Selection** list, choose **Water Domain**.

Steel AISI 4340 (mat3)

- 1 In the **Model Builder** window, click **Steel AISI 4340 (mat3)**.
- 2 In the **Settings** window for **Material**, locate the **Geometric Entity Selection** section.
- 3 From the **Geometric entity level** list, choose **Boundary**.
- 4 From the **Selection** list, choose **Walls**.

TURBULENT FLOW, K- ϵ (SPF)

Since the density variation is not small, the flow cannot be regarded as incompressible. Therefore set the flow to be compressible.

- 1 In the **Model Builder** window, under **Component 1 (comp1)** click **Turbulent Flow, k- ϵ (spf)**.
- 2 In the **Settings** window for **Turbulent Flow, k- ϵ** , locate the **Physical Model** section.
- 3 From the **Compressibility** list, choose **Compressible flow (Ma<0.3)**.

The next step is to set the boundary conditions. At first the boundary conditions for the flow equations are applied. These are the inlet and outlet boundary conditions, symmetry as well as the interior walls which separate the air from the water domain. The default wall boundary condition then applies to the outer boundaries.

Inlet 1: Water

- 1 In the **Physics** toolbar, click  **Boundaries** and choose **Inlet**.
- 2 In the **Settings** window for **Inlet**, type Inlet 1: Water in the **Label** text field.
- 3 Locate the **Boundary Selection** section. From the **Selection** list, choose **Inlet Water**.

- 4 Locate the **Boundary Condition** section. From the list, choose **Fully developed flow**.
- 5 Locate the **Fully Developed Flow** section. In the U_{av} text field, type `u_water`.

Outlet 1: Water

- 1 In the **Physics** toolbar, click  **Boundaries** and choose **Outlet**.
- 2 In the **Settings** window for **Outlet**, type `Outlet 1: Water` in the **Label** text field.
- 3 Locate the **Boundary Selection** section. From the **Selection** list, choose **Outlet Water**.
- 4 Locate the **Pressure Conditions** section. Select the **Normal flow** checkbox.

Inlet 2: Air

- 1 In the **Physics** toolbar, click  **Boundaries** and choose **Inlet**.
- 2 In the **Settings** window for **Inlet**, type `Inlet 2: Air` in the **Label** text field.
- 3 Locate the **Boundary Selection** section. From the **Selection** list, choose **Inlet Air**.
- 4 Locate the **Boundary Condition** section. From the list, choose **Fully developed flow**.
- 5 Locate the **Fully Developed Flow** section. In the U_{av} text field, type `u_air`.

Outlet 2: Air

- 1 In the **Physics** toolbar, click  **Boundaries** and choose **Outlet**.
- 2 In the **Settings** window for **Outlet**, type `Outlet 2: Air` in the **Label** text field.
- 3 Locate the **Boundary Selection** section. From the **Selection** list, choose **Outlet Air**.
- 4 Locate the **Pressure Conditions** section. Select the **Normal flow** checkbox.

Symmetry 1

- 1 In the **Physics** toolbar, click  **Boundaries** and choose **Symmetry**.
- 2 In the **Settings** window for **Symmetry**, locate the **Boundary Selection** section.
- 3 From the **Selection** list, choose **Symmetry**.

Interior Wall 1

- 1 In the **Physics** toolbar, click  **Boundaries** and choose **Interior Wall**.
- 2 In the **Settings** window for **Interior Wall**, locate the **Boundary Selection** section.
- 3 From the **Selection** list, choose **Interior Walls**.

The boundary conditions that set up the heat transfer equation are the temperatures at the inlets and the outflow at the outlets, the symmetry and for all walls the thin layer feature accounts for the heat conduction through the shell.

HEAT TRANSFER IN FLUIDS (HT)

In the **Model Builder** window, under **Component 1 (comp1)** click **Heat Transfer in Fluids (ht)**.

Inflow 1: Water

- 1 In the **Physics** toolbar, click  **Boundaries** and choose **Inflow**.
- 2 In the **Settings** window for **Inflow**, type Inflow 1: Water in the **Label** text field.
- 3 Locate the **Boundary Selection** section. From the **Selection** list, choose **Inlet Water**.
- 4 Locate the **Upstream Properties** section. In the T_{ustr} text field, type T_{water} .

Outflow 1: Water

- 1 In the **Physics** toolbar, click  **Boundaries** and choose **Outflow**.
- 2 In the **Settings** window for **Outflow**, type Outflow 1: Water in the **Label** text field.
- 3 Locate the **Boundary Selection** section. From the **Selection** list, choose **Outlet Water**.

Inflow 2: Air

- 1 In the **Physics** toolbar, click  **Boundaries** and choose **Inflow**.
- 2 In the **Settings** window for **Inflow**, type Inflow 2: Air in the **Label** text field.
- 3 Locate the **Boundary Selection** section. From the **Selection** list, choose **Inlet Air**.
- 4 Locate the **Upstream Properties** section. In the T_{ustr} text field, type T_{air} .

Outflow 2: Air

- 1 In the **Physics** toolbar, click  **Boundaries** and choose **Outflow**.
- 2 In the **Settings** window for **Outflow**, type Outflow 2: Air in the **Label** text field.
- 3 Locate the **Boundary Selection** section. From the **Selection** list, choose **Outlet Air**.

Symmetry 1

- 1 In the **Physics** toolbar, click  **Boundaries** and choose **Symmetry**.
- 2 In the **Settings** window for **Symmetry**, locate the **Boundary Selection** section.
- 3 From the **Selection** list, choose **Symmetry**.

Thin Layer 1

- 1 In the **Physics** toolbar, click  **Boundaries** and choose **Thin Layer**.
- 2 In the **Settings** window for **Thin Layer**, locate the **Boundary Selection** section.
- 3 From the **Selection** list, choose **Walls**.
- 4 Locate the **Shell Properties** section. From the **Shell type** list, choose **Nonlayered shell**. In the L_{th} text field, type 1 [mm].
- 5 Locate the **Layer Model** section. From the **Layer type** list, choose **Thermally thin approximation**.

The physics is now defined. For evaluating the equivalent heat transfer coefficient according to [Equation 1](#) directly after solving the model, you need to define the following nonlocal coupling. It can also be defined and evaluated after computing the simulation, but in this case you need to choose **Update Solution** (after right-clicking on the **Study 1** node) to make this coupling available without running the model again.

DEFINITIONS

Average Operator on Water-Air Interface

- 1 In the **Definitions** toolbar, click  **Nonlocal Couplings** and choose **Average**.
- 2 In the **Settings** window for **Average**, type Average Operator on Water-Air Interface in the **Label** text field.
- 3 Locate the **Source Selection** section. From the **Geometric entity level** list, choose **Boundary**.
- 4 From the **Selection** list, choose **Water-Air Interface**.

The heat exchanger properties and operating conditions are well defined and the model is ready to solve. For a first estimation of the heat exchanger performance a coarse mesh is satisfying. The solution is obtained very fast and provides qualitatively good results. Reliable quantitative results require a good resolution especially of the wall regions.

The default physics-controlled mesh is a good starting point and can be customized to reduce computational costs. Here you reduce the number of boundary layers and scale the geometry for the meshing sequence in the x direction. This results in an anisotropic mesh that is suitable for the minor changes of the flow field and temperature field in the x direction.

MESH 1

- 1 In the **Model Builder** window, under **Component 1 (comp1)** click **Mesh 1**.
- 2 In the **Settings** window for **Mesh**, locate the **Physics-Controlled Mesh** section.
- 3 From the **Element size** list, choose **Extremely coarse**.
- 4 In the table, clear the **Use** checkbox for **Geometric Analysis, Detail Size**.
- 5 Right-click **Component 1 (comp1)** > **Mesh 1** and choose **Edit Physics-Induced Sequence**.

Free Tetrahedral 1

- 1 In the **Model Builder** window, under **Component 1 (comp1)** > **Mesh 1** click **Free Tetrahedral 1**.
- 2 In the **Settings** window for **Free Tetrahedral**, click to expand the **Scale Geometry** section.

3 In the **x-direction scale** text field, type 0.5.

Boundary Layer Properties I

1 In the **Model Builder** window, expand the **Component 1 (comp1) > Mesh 1 > Boundary Layers 1** node, then click **Boundary Layer Properties 1**.

2 In the **Settings** window for **Boundary Layer Properties**, locate the **Layers** section.

3 In the **Number of layers** text field, type 3.

4 In the **Thickness adjustment factor** text field, type 2.

5 Click  **Build All**.

STUDY 1

In the **Study** toolbar, click  **Compute**.

RESULTS

Velocity (spf)

A multislice plot of the velocity field, a surface pressure plot, a surface plot of the wall resolution and a volume plot of the temperature are generated by default. You can either customize these plots, add plots from the **Result Templates**, or create new plot groups to visualize the results.

The wall resolution indicates the accuracy of the flow close to the walls where the wall functions are applied. The variable `spf.Delta_wPlus` takes values close to the lower limit, 11.06, which indicates that the wall functions give reasonable predictions.

Wall Lift-off

1 In the **Results** toolbar, click  **3D Plot Group**.

2 In the **Settings** window for **3D Plot Group**, type `Wall Lift-off` in the **Label** text field.

3 Click to expand the **Selection** section. From the **Geometric entity level** list, choose **Boundary**.

4 From the **Selection** list, choose **Interior Walls**.

5 Locate the **Color Legend** section. Select the **Show units** checkbox.

Downside Wall Lift-off

1 Right-click **Wall Lift-off** and choose **Surface**.

The wall lift-off `spf.delta_w` needs to be significantly smaller than the dimension of the geometry. On interior boundaries, these variables are available for the upside and downside of the wall indicated by `spf.d_w_plus_u/d` or `spf.delta_w_u/d`, respectively. The critical regions in terms of the wall resolution are in the tubes, where

the computed wall lift-off is about 0.5 mm which has to be compared with the pipe diameter 15 mm. A finer mesh would lead to a lower wall lift-off value and hence to a better accuracy.

- 2 In the **Settings** window for **Surface**, type `Downside Wall Lift-off` in the **Label** text field.
- 3 Locate the **Expression** section. In the **Expression** text field, type `spf.delta_w_d`.
- 4 In the **Wall Lift-off** toolbar, click  **Plot**.

Figure 4 shows the temperature distribution on all wall boundaries. The default temperature plot uses a **Volume** node to show the temperature in the fluid, which can be removed to display the wall temperature only.

Temperature (ht)

- 1 In the **Model Builder** window, under **Results** click **Temperature (ht)**.
- 2 In the **Settings** window for **3D Plot Group**, click to expand the **Title** section.
- 3 From the **Title type** list, choose **Label**.

Domain

- 1 In the **Model Builder** window, expand the **Temperature (ht)** node.
- 2 Right-click **Domain** and choose **Delete**.

Nonlayered Shell

- 1 In the **Settings** window for **Surface Slit**, locate the **Expression on the Upside** section.
- 2 From the **Unit** list, choose **°C**.
- 3 Locate the **Expression on the Downside** section. From the **Unit** list, choose **°C**.
- 4 Click to expand the **Range** section. Select the **Manual color range** checkbox.
- 5 In the **Minimum** text field, type 65.
- 6 In the **Maximum** text field, type 80.
- 7 Locate the **Coloring and Style** section. From the **Color table** list, choose **HeatCameraLight**.
- 8 In the **Temperature (ht)** toolbar, click  **Plot**.

In Figure 3, the streamlines are plotted for the full 3D geometry. Even if only one half of the heat exchanger is modeled the solution can be mirrored to obtain a full 3D view of the results. To do so, follow the steps below:

Mirror 3D 1

- 1 In the **Results** toolbar, click  **More Datasets** and choose **Mirror 3D**.
- 2 In the **Settings** window for **Mirror 3D**, locate the **Plane Data** section.

- 3 From the **Plane** list, choose **zx-planes**.

Temperature Along Streamlines

- 1 In the **Results** toolbar, click  **3D Plot Group**.
- 2 In the **Settings** window for **3D Plot Group**, type Temperature Along Streamlines in the **Label** text field.
- 3 Locate the **Data** section. From the **Dataset** list, choose **Mirror 3D I**.
- 4 Locate the **Title** section. From the **Title type** list, choose **Manual**.
- 5 In the **Title** text area, type Streamline: Temperature along streamlines.
- 6 Locate the **Color Legend** section. Select the **Show units** checkbox.

Streamline I

- 1 In the **Temperature Along Streamlines** toolbar, click  **Streamline**.
- 2 In the **Settings** window for **Streamline**, locate the **Streamline Positioning** section.
- 3 In the **Points** text field, type 100.
- 4 Locate the **Coloring and Style** section. Find the **Line style** subsection. From the **Type** list, choose **Tube**.

Color Expression I

- 1 In the **Temperature Along Streamlines** toolbar, click  **Color Expression**.
- 2 In the **Settings** window for **Color Expression**, click **Replace Expression** in the upper-right corner of the **Expression** section. From the menu, choose **Component I (comp1) > Heat Transfer in Fluids > Temperature > T - Temperature - K**.
- 3 Locate the **Coloring and Style** section. From the **Color table** list, choose **HeatCameraLight**.
- 4 Locate the **Expression** section. From the **Unit** list, choose **°C**.

Temperature Along Streamlines

Evaluate the equivalent heat transfer coefficient by using the nonlocal couplings defined previously.

Heat Transfer Coefficient

- 1 In the **Results** toolbar, click  **Global Evaluation**.
- 2 In the **Settings** window for **Global Evaluation**, type Heat Transfer Coefficient in the **Label** text field.

3 Locate the **Expressions** section. In the table, enter the following settings:

Expression	Unit	Description
$\text{aveop1}(\text{abs}(\text{nitf1.qwf_u}) / (\text{T_water} - \text{T_air}))$	W / (m ² *K)	

The variable `nitf1.qwf_u` efficiently computes the heat flux through the wall separating water and air domains, based on the wall function definition.

4 Click  **Evaluate**.

To evaluate the pressure drop, the average inlet pressures are computed.

Inlet Pressure, Water

- 1 In the **Results** toolbar, click $\frac{8.85}{e-12}$ **More Derived Values** and choose **Average > Surface Average**.
- 2 In the **Settings** window for **Surface Average**, type Inlet Pressure, Water in the **Label** text field.
- 3 Locate the **Selection** section. From the **Selection** list, choose **Inlet Water**.
- 4 Click **Replace Expression** in the upper-right corner of the **Expressions** section. From the menu, choose **Component I (comp1) > Turbulent Flow, k-ε > Velocity and pressure > p - Pressure - Pa**.
- 5 Click  **Evaluate**.

Inlet Pressure, Air

- 1 In the **Results** toolbar, click $\frac{8.85}{e-12}$ **More Derived Values** and choose **Average > Surface Average**.
- 2 In the **Settings** window for **Surface Average**, type Inlet Pressure, Air in the **Label** text field.
- 3 Locate the **Selection** section. From the **Selection** list, choose **Inlet Air**.
- 4 Click **Replace Expression** in the upper-right corner of the **Expressions** section. From the menu, choose **Component I (comp1) > Turbulent Flow, k-ε > Velocity and pressure > p - Pressure - Pa**.
- 5 Click  **Evaluate**.

TABLE 3

1 Go to the **Table 3** window.

The tube side pressure drop is slightly lower than 40 Pa and the shell side pressure drop is 13 Pa.

Geometry Modeling Instructions

If you want to create the geometry yourself, follow these steps.

GEOMETRY 1

- 1 In the **Model Builder** window, under **Component 1 (comp1)** click **Geometry 1**.
- 2 In the **Settings** window for **Geometry**, locate the **Units** section.
- 3 From the **Length unit** list, choose **mm**.

Cylinder 1 (cyl1)

- 1 In the **Geometry** toolbar, click  **Cylinder**.
- 2 In the **Settings** window for **Cylinder**, locate the **Size and Shape** section.
- 3 In the **Radius** text field, type 100.
- 4 In the **Height** text field, type 500.
- 5 Locate the **Axis** section. From the **Axis type** list, choose **x-axis**.

Cylinder 2 (cyl2)

- 1 In the **Geometry** toolbar, click  **Cylinder**.
- 2 In the **Settings** window for **Cylinder**, locate the **Size and Shape** section.
- 3 In the **Radius** text field, type 50.
- 4 In the **Height** text field, type 750.
- 5 Locate the **Position** section. In the **x** text field, type -125.
- 6 Locate the **Axis** section. From the **Axis type** list, choose **x-axis**.

Sphere 1 (sph1)

- 1 In the **Geometry** toolbar, click  **Sphere**.
- 2 In the **Settings** window for **Sphere**, locate the **Size** section.
- 3 In the **Radius** text field, type 100.

Sphere 2 (sph2)

- 1 In the **Geometry** toolbar, click  **Sphere**.
- 2 In the **Settings** window for **Sphere**, locate the **Size** section.
- 3 In the **Radius** text field, type 100.
- 4 Locate the **Position** section. In the **x** text field, type 500.

Cylinder 3 (cyl3)

- 1 In the **Geometry** toolbar, click  **Cylinder**.

- 2 In the **Settings** window for **Cylinder**, locate the **Size and Shape** section.
- 3 In the **Radius** text field, type 45.
- 4 In the **Height** text field, type 132.5.
- 5 Locate the **Position** section. In the **x** text field, type 50.
- 6 In the **z** text field, type -132.5.

Cylinder 4 (cyl4)

- 1 Right-click **Cylinder 3 (cyl3)** and choose **Duplicate**.
- 2 In the **Settings** window for **Cylinder**, locate the **Position** section.
- 3 In the **x** text field, type 450.
- 4 In the **z** text field, type 0.

Union 1 (unil)

- 1 In the **Geometry** toolbar, click  **Booleans and Partitions** and choose **Union**.
- 2 Click in the **Graphics** window and then press Ctrl+A to select all objects.
- 3 In the **Settings** window for **Union**, locate the **Union** section.
- 4 Clear the **Keep interior boundaries** checkbox.

Block 1 (blk1)

- 1 In the **Geometry** toolbar, click  **Block**.
- 2 In the **Settings** window for **Block**, locate the **Size and Shape** section.
- 3 In the **Width** text field, type 500.
- 4 In the **Depth** text field, type 300.
- 5 In the **Height** text field, type 300.
- 6 Locate the **Position** section. In the **y** text field, type -150.
- 7 In the **z** text field, type -150.
- 8 Click to expand the **Layers** section. Find the **Layer position** subsection. Select the **Right** checkbox.
- 9 Clear the **Bottom** checkbox.
- 10 In the table, enter the following settings:



Layer name	Thickness (mm)
Layer 1	100
Layer 2	100

Layer name	Thickness (mm)
Layer 3	100
Layer 4	100

Block 2 (blk2)

- 1 In the **Geometry** toolbar, click  **Block**.
- 2 In the **Settings** window for **Block**, locate the **Size and Shape** section.
- 3 In the **Width** text field, type 500.
- 4 In the **Depth** text field, type 300.
- 5 In the **Height** text field, type 65.
- 6 Locate the **Position** section. In the **y** text field, type -150.
- 7 In the **z** text field, type -32.5.

Partition Objects 1 (par1)

- 1 In the **Geometry** toolbar, click  **Booleans and Partitions** and choose **Partition Objects**.
- 2 Select the object **uni1** only.
- 3 In the **Settings** window for **Partition Objects**, locate the **Partition Objects** section.
- 4 Click to select the  **Activate Selection** toggle button for **Tool objects**.
- 5 Select the objects **blk1** and **blk2** only.

Work Plane 1 (wp1)

- 1 In the **Geometry** toolbar, click  **Work Plane**.
- 2 In the **Settings** window for **Work Plane**, locate the **Plane Definition** section.
- 3 From the **Plane** list, choose **yz-plane**.

Work Plane 1 (wp1) > Plane Geometry

In the **Model Builder** window, click **Plane Geometry**.

Work Plane 1 (wp1) > Circle 1 (c1)

- 1 In the **Work Plane** toolbar, click  **Circle**.
- 2 In the **Settings** window for **Circle**, locate the **Size and Shape** section.
- 3 In the **Radius** text field, type 7.5.
- 4 Locate the **Position** section. In the **xw** text field, type -75.
- 5 In the **yw** text field, type -43.5.

Work Plane 1 (wp1) > Array 1 (arr1)



- 1 In the **Work Plane** toolbar, click  **Transforms** and choose **Array**.

- 2 Select the object **c1** only.
- 3 In the **Settings** window for **Array**, locate the **Size** section.
- 4 In the **xw size** text field, type 7.
- 5 In the **yw size** text field, type 3.
- 6 Locate the **Displacement** section. In the **xw** text field, type 25.
- 7 In the **yw** text field, type 43.5.

Work Plane 1 (wp1) > Circle 2 (c2)

- 1 In the **Model Builder** window, under **Component 1 (comp1) > Geometry 1 > Work Plane 1 (wp1) > Plane Geometry** right-click **Circle 1 (c1)** and choose **Duplicate**.
- 2 In the **Settings** window for **Circle**, locate the **Position** section.
- 3 In the **xw** text field, type -62.5.
- 4 In the **yw** text field, type -65.25.

Work Plane 1 (wp1) > Array 2 (arr2)

- 1 In the **Work Plane** toolbar, click  **Transforms** and choose **Array**.
- 2 Select the object **c2** only.
- 3 In the **Settings** window for **Array**, locate the **Size** section.
- 4 In the **xw size** text field, type 6.
- 5 In the **yw size** text field, type 4.
- 6 Locate the **Displacement** section. In the **xw** text field, type 25.
- 7 In the **yw** text field, type 43.5.
- 8 Click  **Build Selected**.

Work Plane 1 (wp1) > Delete Entities 1 (dell)

- 1 In the **Work Plane** toolbar, click  **Delete**.
- 2 Select the objects **arr1(1,1)**, **arr1(1,3)**, **arr1(7,1)**, **arr1(7,3)**, **arr2(1,1)**, **arr2(1,4)**, **arr2(6,1)**, and **arr2(6,4)** only.

Extrude 1 (ext1)

- 1 In the **Model Builder** window, under **Component 1 (comp1) > Geometry 1** right-click **Work Plane 1 (wp1)** and choose **Extrude**.
- 2 In the **Settings** window for **Extrude**, locate the **Distances** section.

3 In the table, enter the following settings:



Distances (mm)

500



Block 3 (blk3)

- 1 In the **Geometry** toolbar, click  **Block**.
- 2 In the **Settings** window for **Block**, locate the **Size and Shape** section.
- 3 In the **Width** text field, type 1 [m].
- 4 In the **Depth** text field, type 150.
- 5 In the **Height** text field, type 400.
- 6 Locate the **Position** section. In the **x** text field, type -200.
- 7 In the **y** text field, type -150.
- 8 In the **z** text field, type -200.

Difference 1 (dif1)

- 1 In the **Geometry** toolbar, click  **Booleans and Partitions** and choose **Difference**.
- 2 Select the objects **ext1** and **par1** only.
- 3 In the **Settings** window for **Difference**, locate the **Difference** section.
- 4 Click to select the  **Activate Selection** toggle button for **Objects to subtract**.
- 5 Select the object **blk3** only.

Ignore Faces 1 (igf1)

- 1 In the **Geometry** toolbar, click  **Virtual Operations** and choose **Ignore Faces**.
- 2 Click the  **Go to Default View** button in the **Graphics** toolbar.
- 3 Click the  **Wireframe Rendering** button in the **Graphics** toolbar.
- 4 On the object **fin**, select Boundaries 10, 17, 18, 25, 26, 32, 35, 38, 41, 52, 55, 58, 67, 70, 73, 76, 87, 90, 93, 102, 105, 112, 125, 132, 133, 138, 140, 141, 147, 150, 153, 156, 167, 170, 173, 182, 185, 188, 191, 202, 205, 208, 217, 220, 227, 234, 237, 244, 245, 252, 253, 259, 262, 265, 268, 279, 282, 285, 294, 297, 300, 303, 314, 317, 320, 329, 332, 339, 349, 356, 357, 362, 364, 365, 371, 374, 377, 380, 391, 394, 397, 406, 409, 412, 415, 426, 429, 432, 441, 444, 451, 458, 461, 468, 469, 476, 477, 483, 486, 489, 492, 503, 506, 509, 518, 521, 524, 527, 538, 541, 544, 553, 556, 563, 576, 578, 580, and 582–598 only.

Water Domain



- 1 In the **Geometry** toolbar, click  **Selections** and choose **Explicit Selection**.

- 2 In the **Settings** window for **Explicit Selection**, type Water Domain in the **Label** text field.
- 3 On the object **igfl**, select Domain 1 only.



Air Domain

- 1 In the **Geometry** toolbar, click  **Selections** and choose **Explicit Selection**.
- 2 In the **Settings** window for **Explicit Selection**, type Air Domain in the **Label** text field.
- 3 On the object **igfl**, select Domain 2 only.



Water Domain, Exterior Boundaries

- 1 In the **Geometry** toolbar, click  **Selections** and choose **Adjacent Selection**.
- 2 In the **Settings** window for **Adjacent Selection**, type Water Domain, Exterior Boundaries in the **Label** text field.
- 3 Locate the **Input Entities** section. Click  **Add**.
- 4 In the **Add** dialog, select **Water Domain** in the **Input selections** list.
- 5 Click **OK**.

Air Domain, Exterior Boundaries

- 1 In the **Geometry** toolbar, click  **Selections** and choose **Adjacent Selection**.
- 2 In the **Settings** window for **Adjacent Selection**, type Air Domain, Exterior Boundaries in the **Label** text field.
- 3 Locate the **Input Entities** section. Click  **Add**.
- 4 In the **Add** dialog, select **Air Domain** in the **Input selections** list.
- 5 Click **OK**.

Baffles

- 1 In the **Geometry** toolbar, click  **Selections** and choose **Adjacent Selection**.
- 2 In the **Settings** window for **Adjacent Selection**, type Baffles in the **Label** text field.
- 3 Locate the **Input Entities** section. Click  **Add**.
- 4 In the **Add** dialog, select **Air Domain** in the **Input selections** list.
- 5 Click **OK**.
- 6 In the **Settings** window for **Adjacent Selection**, locate the **Output Entities** section.
- 7 From the **Exterior boundaries** list, choose **None**.
- 8 Select the **Interior boundaries** checkbox.

Symmetry

- 1 In the **Geometry** toolbar, click  **Selections** and choose **Box Selection**.

- 2 In the **Settings** window for **Box Selection**, type Symmetry in the **Label** text field.
- 3 Locate the **Geometric Entity Level** section. From the **Level** list, choose **Boundary**.
- 4 Locate the **Box Limits** section. In the **y maximum** text field, type 0.
- 5 Locate the **Output Entities** section. From the **Include entity if** list, choose **Entity inside box**.

Inlet Water

- 1 In the **Geometry** toolbar, click  **Selections** and choose **Explicit Selection**.
- 2 In the **Settings** window for **Explicit Selection**, type Inlet Water in the **Label** text field.
- 3 Locate the **Entities to Select** section. From the **Geometric entity level** list, choose **Boundary**.
- 4 On the object **igfl**, select Boundary 1 only.

Outlet Water

- 1 In the **Geometry** toolbar, click  **Selections** and choose **Explicit Selection**.
- 2 In the **Settings** window for **Explicit Selection**, type Outlet Water in the **Label** text field.
- 3 Locate the **Entities to Select** section. From the **Geometric entity level** list, choose **Boundary**.
- 4 On the object **igfl**, select Boundary 339 only.

Inlet Air

- 1 In the **Geometry** toolbar, click  **Selections** and choose **Explicit Selection**.
- 2 In the **Settings** window for **Explicit Selection**, type Inlet Air in the **Label** text field.
- 3 Locate the **Entities to Select** section. From the **Geometric entity level** list, choose **Boundary**.
- 4 On the object **igfl**, select Boundary 332 only.

Outlet Air

- 1 In the **Geometry** toolbar, click  **Selections** and choose **Explicit Selection**.
- 2 In the **Settings** window for **Explicit Selection**, type Outlet Air in the **Label** text field.
- 3 Locate the **Entities to Select** section. From the **Geometric entity level** list, choose **Boundary**.
- 4 On the object **igfl**, select Boundary 89 only.

Water Domain, Walls

- 1 In the **Geometry** toolbar, click  **Selections** and choose **Difference Selection**.

- 2 In the **Settings** window for **Difference Selection**, type Water Domain, Walls in the **Label** text field.
- 3 Locate the **Geometric Entity Level** section. From the **Level** list, choose **Boundary**.
- 4 Locate the **Input Entities** section. Click the **+ Add** button for **Selections to add**.
- 5 In the **Add** dialog, select **Water Domain, Exterior Boundaries** in the **Selections to add** list.
- 6 Click **OK**.
- 7 In the **Settings** window for **Difference Selection**, locate the **Input Entities** section.
- 8 Click the **+ Add** button for **Selections to subtract**.
- 9 In the **Add** dialog, in the **Selections to subtract** list, choose **Symmetry, Inlet Water**, and **Outlet Water**.
- 10 Click **OK**.

Air Domain, Walls

- 1 In the **Geometry** toolbar, click  **Selections** and choose **Difference Selection**.
- 2 In the **Settings** window for **Difference Selection**, locate the **Geometric Entity Level** section.
- 3 From the **Level** list, choose **Boundary**.
- 4 In the **Label** text field, type Air Domain, Walls.
- 5 Locate the **Input Entities** section. Click the **+ Add** button for **Selections to add**.
- 6 In the **Add** dialog, in the **Selections to add** list, choose **Air Domain, Exterior Boundaries** and **Baffles**.
- 7 Click **OK**.
- 8 In the **Settings** window for **Difference Selection**, locate the **Input Entities** section.
- 9 Click the **+ Add** button for **Selections to subtract**.
- 10 In the **Add** dialog, in the **Selections to subtract** list, choose **Symmetry, Inlet Air**, and **Outlet Air**.
- 11 Click **OK**.

Walls

- 1 In the **Geometry** toolbar, click  **Selections** and choose **Union Selection**.
- 2 In the **Settings** window for **Union Selection**, locate the **Geometric Entity Level** section.
- 3 From the **Level** list, choose **Boundary**.
- 4 Locate the **Input Entities** section. Click **+ Add**.
- 5 In the **Add** dialog, in the **Selections to add** list, choose **Water Domain, Walls** and **Air Domain, Walls**.

6 Click **OK**.

7 In the **Settings** window for **Union Selection**, type Walls in the **Label** text field.

Water-Air Interface

1 In the **Geometry** toolbar, click  **Selections** and choose **Intersection Selection**.

2 In the **Settings** window for **Intersection Selection**, type Water-Air Interface in the **Label** text field.

3 Locate the **Geometric Entity Level** section. From the **Level** list, choose **Boundary**.

4 Locate the **Input Entities** section. Click  **Add**.

5 In the **Add** dialog, in the **Selections to intersect** list, choose **Water Domain, Walls** and **Air Domain, Walls**.

6 Click **OK**.

Interior Walls

1 In the **Geometry** toolbar, click  **Selections** and choose **Union Selection**.

2 In the **Settings** window for **Union Selection**, locate the **Geometric Entity Level** section.

3 From the **Level** list, choose **Boundary**.

4 Locate the **Input Entities** section. Click  **Add**.

5 In the **Add** dialog, in the **Selections to add** list, choose **Baffles** and **Water-Air Interface**.

6 Click **OK**.

7 In the **Settings** window for **Union Selection**, type Interior Walls in the **Label** text field.