



Model created in COMSOL Multiphysics 6.4

# Power Transistor

## *Introduction*

---

Transistors are building blocks of electronic appliances, and can be found in radios, computers, and calculators, to name a few. When working with electrical systems you typically have to deal with heat transfer; electric heating is often an unwanted result of current conduction.

This example simulates a system consisting of a small part of a circuit board containing a power transistor and the copper pathways connected to the transistor. The purpose of the simulation is to estimate the operating temperature of the transistor, which can be substantially higher than room temperature due to undesired electric heating.

Transistors are semiconductor devices used to switch or amplify electronic signals. There are different types of transistors, ranging in size depending on how they are packaged. Power transistors carry and dissipate more power and therefore come in larger packages. These packages can be attached to a heat sink for better cooling and to avoid overheating of the system.

The heat sink would then be attached to the transistor via the copper plate located behind the ceramic piece (shown in [Figure 1](#) to the left). While it's often important to construct a way to cool electronic systems, such as in the case of components in hybrid cars, each system has its own acceptable operating temperature range. What determines the maximum and minimum temperature limits include the semiconductor material properties, the transistor type, the design of the device, and so forth. There is a conventional temperature range, however, which is thought to be between  $-55^{\circ}\text{C}$  and  $125^{\circ}\text{C}$ .

## *Model Definition*

---

[Figure 1](#) shows the model geometry used in the simulation. The power transistor is mounted on the circuit board using through-hole technology. The solder in the holes give

mechanical support and electronic contact between the copper routes and the transistor pins.

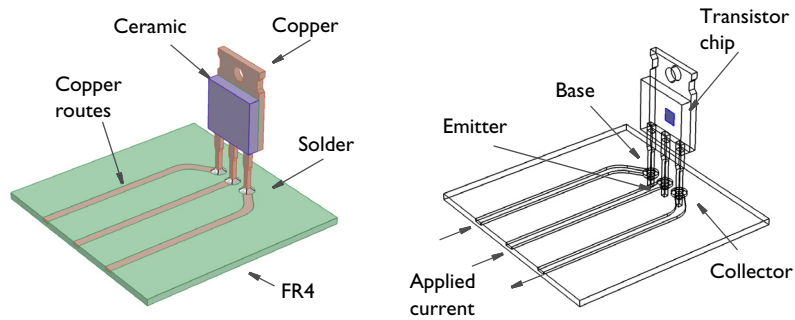

*Figure 1: Model geometry and position of transistor chip.*

The transistor chip itself is a very thin structure represented by an internal surface in [Figure 1](#). The chip is connected to the pins but these connections are assumed to have negligible effects on heat transfer.

The transistor package front part is made of ceramics while the back part, which could be clamped to a heat sink, is made of copper. The transistor chip and the front part of the package have matching thermal properties. The copper pins are soldered to the circuit board by the solder material 60Sn-40Pb (60% tin and 40% lead). The circuit board is made of FR4.

Current conduction and Joule heating take place in the copper routes, in the solders, and in the pins. In these parts, the physics of heat transfer and heat production due to Joule heating are fully coupled to the conduction of electric current. In all other parts of the transistor, only heat transfer and heat production take place.

The transistor chip itself is represented by an interior boundary with an internal production of heat corresponding to 0.9 W. Cooling through convection takes place at all external boundaries with a heat transfer coefficient of  $5.0 \text{ W}/(\text{m}^2 \cdot \text{K})$ . This value of the heat transfer coefficient corresponds to the worst case scenario when the fan is switched off. The ambient temperature is 293.15 K.

Current enters the circuit board at the left vertical boundaries of the copper routes connected to the base, emitter, and collector in [Figure 1](#). The value of the current at the boundary of the route connected to the emitter is 0.2 A. The value of the current at the boundary of the route connected to the collector is 0.1998 A. The difference in absolute

current between the emitter and collector currents corresponds to the current at the boundary of the route connected to the base, which is 0.2 mA.

## Results and Discussion

---

Figure 2 below shows the temperature distribution in the device. The maximum temperature is about 354 K or 81°C. This is well within the acceptable operation temperature range for the transistor, which implies that attaching it to a heat sink is not needed in this case.

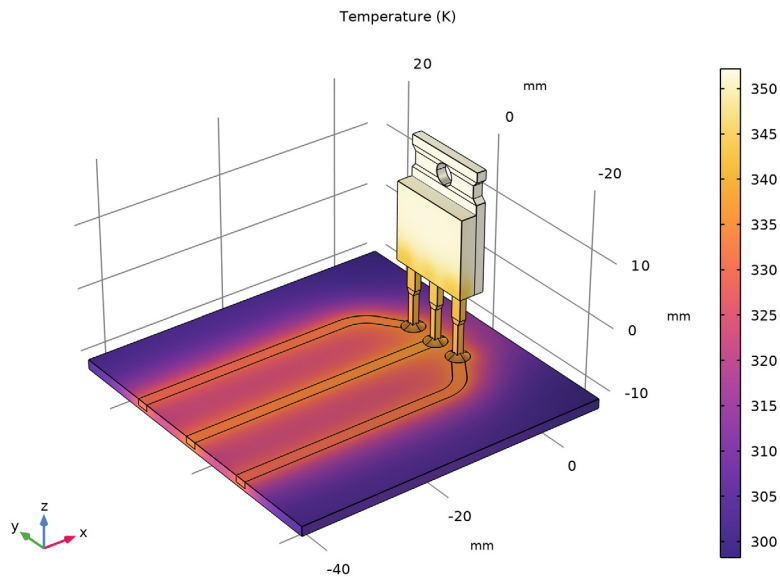
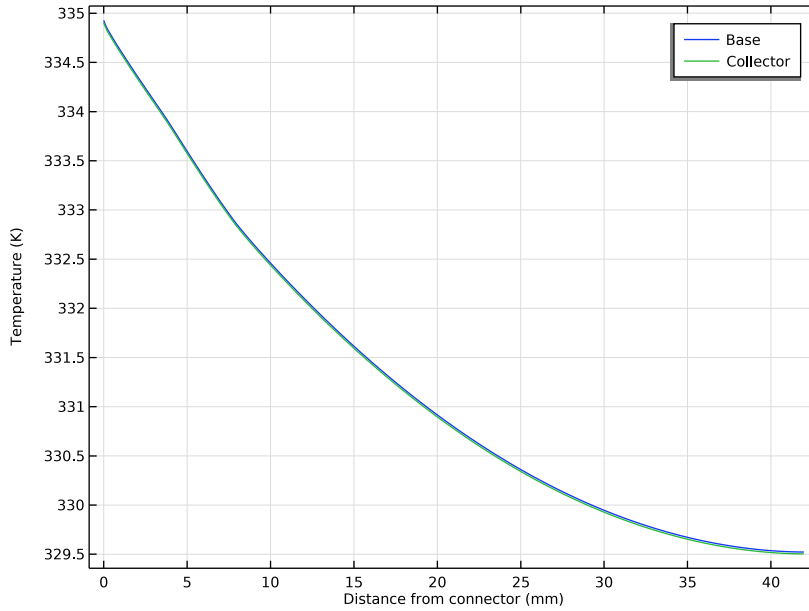

Figure 2: Temperature distribution.

Also worth noting is that electric heating, or Joule heating as it is also referred to, hardly influences the temperature of the copper routes at the distance from the transistor modeled above. That's most likely due to copper's high conductivity; some of the heat produced in the transistor chip is conducted away from the device via the copper routes.

Figure 3 shows the temperature along the copper routes connected to the base and the collector respectively. The current density in the base is 1/1000 of that in the collector but

the temperature in the copper routes connected to the base and collector is almost identical.



*Figure 3: Temperature along the copper routes connected to the base and collector.*

The fact that the Joule heating effect does not increase temperature in the copper routes leads to the conclusion that the higher temperature in these routes is due to coppers high conductivity. The copper routes conduct some of the heat produced in the transistor chip away from this device. The circuit board has a poor thermal conductivity and is therefore not heated to the same extent as the copper routes.

### *Notes About the COMSOL Implementation*

---

You can find all the material properties for this application in COMSOL's Material Library. Furthermore, the ready-made physics interface for Joule heating sets up all model formulations that you need for the simulation: Electric Current and Heat Transfer in Solids are added with the corresponding Joule Heating coupling features in the Multiphysics node.

The Joule heating interface is by default available for all materials in the model. However, the circuit board material and the package material do not conduct electric current. For this reason, you have to edit the selection of Electric current physics to remove nonconducting

domains. On the circuit board material, only heat transfer physics is calculated. By removing the nonconductive parts of the device to the list of Electric Current physics, Electromagnetic Heat Source and Boundary Electromagnetic Heat Source are automatically not applicable on these domains.

---

**Application Library path:** Heat\_Transfer\_Module/  
Power\_Electronics\_and\_Electronic\_Cooling/power\_transistor

---

### *Modeling Instructions*



---

From the **File** menu, choose **New**.

#### **NEW**



In the **New** window, click  **Model Wizard**.

#### **MODEL WIZARD**

- 1 In the **Model Wizard** window, click  **3D**.
- 2 In the **Select Physics** tree, select **Heat Transfer > Electromagnetic Heating > Joule Heating**.
- 3 Click **Add**.
- 4 Click  **Study**.
- 5 In the **Select Study** tree, select **General Studies > Stationary**.
- 6 Click  **Done**.

#### **GEOMETRY I**

The geometry sequence for the model is available in a file. If you want to create it from scratch yourself, you can follow the instructions in the [Geometry Modeling Instructions](#) section. Otherwise, insert the geometry sequence as follows:

- 1 In the **Geometry** toolbar, click **Insert Sequence** and choose **Insert Sequence**.
- 2 Browse to the model's Application Libraries folder and double-click the file `power_transistor_geom_sequence.mph`.
- 3 In the **Geometry** toolbar, click  **Build All**.
- 4 Click the  **Zoom Extents** button in the **Graphics** toolbar.

5 In the **Model Builder** window, under **Component 1 (comp1)** click **Geometry 1**.

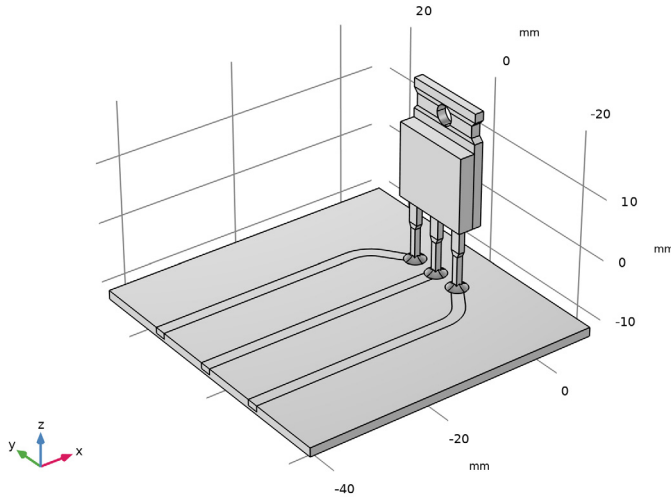

You should now see the geometry shown above.

## GLOBAL DEFINITIONS

### Parameters 1

- 1 In the **Model Builder** window, under **Global Definitions** click **Parameters 1**.
- 2 In the **Settings** window for **Parameters**, locate the **Parameters** section.
- 3 In the table, enter the following settings:

Name	Expression	Value	Description
j_CE	1e5[A/m <sup>2</sup> ]	1E5 A/m <sup>2</sup>	Current density, collector and emitter routes
Q_h	1e5[W/m <sup>2</sup> ]	1E5 W/m <sup>2</sup>	Boundary heat source strength
h_coeff	5[W/(m <sup>2</sup> *K)]	5 W/(m <sup>2</sup> *K)	Heat transfer coefficient



## ADD MATERIAL

- 1 In the **Materials** toolbar, click  **Add Material** to open the **Add Material** window.
- 2 Go to the **Add Material** window.
- 3 In the tree, select **Built-in** > **Copper**.
- 4 Click the **Add to Component** button in the window toolbar.

- 5 In the tree, select **Built-in > FR4 (Circuit Board)**.
- 6 Click the **Add to Component** button in the window toolbar.
- 7 In the tree, select **Built-in > Silica glass**.
- 8 Click the **Add to Component** button in the window toolbar.
- 9 In the tree, select **Built-in > Solder, 60Sn-40Pb**.
- 10 Click the **Add to Component** button in the window toolbar.
- 11 In the **Materials** toolbar, click  **Add Material** to close the **Add Material** window.

## MATERIALS

### *Copper (mat1)*

- 1 Click the  **Wireframe Rendering** button in the **Graphics** toolbar.
- 2 In the **Settings** window for **Material**, locate the **Geometric Entity Selection** section.
- 3 Click  **Clear Selection**.
- 4 Select Domains 2–4 and 9–12 only.

### *FR4 (Circuit Board) (mat2)*

- 1 In the **Model Builder** window, click **FR4 (Circuit Board) (mat2)**.
- 2 Select Domain 1 only.

### *Silica glass (mat3)*

- 1 In the **Model Builder** window, click **Silica glass (mat3)**.
- 2 Select Domain 8 only.

### *Solder, 60Sn-40Pb (mat4)*

- 1 In the **Model Builder** window, click **Solder, 60Sn-40Pb (mat4)**.
- 2 Select Domains 5–7 only.
- 3 In the **Settings** window for **Material**, locate the **Material Contents** section.
- 4 In the table, enter the following settings:

Property	Variable	Value	Unit	Property group
Relative permittivity	epsilon <sub>nr_</sub> iso ; epsilon <sub>nrii</sub> = epsilon <sub>nr_</sub> iso, epsilon <sub>nrij</sub> = 0	1		Basic

## ELECTRIC CURRENTS (EC)

- 1 In the **Model Builder** window, under **Component 1 (comp1)** click **Electric Currents (ec)**.
- 2 Select Domains 2–7 and 9–11 only.

### *Ground 1*

- 1 In the **Physics** toolbar, click  **Boundaries** and choose **Ground**.
- 2 Select Boundaries 84, 104, and 124 only.

### *Normal Current Density 1*

- 1 In the **Physics** toolbar, click  **Boundaries** and choose **Normal Current Density**.
- 2 Select Boundary 10 only.
- 3 In the **Settings** window for **Normal Current Density**, locate the **Normal Current Density** section.
- 4 In the  $J_n$  text field, type  $(1 \cdot 1e-3) * j\_CE$ .

### *Normal Current Density 2*

- 1 In the **Physics** toolbar, click  **Boundaries** and choose **Normal Current Density**.
- 2 Select Boundary 5 only.
- 3 In the **Settings** window for **Normal Current Density**, locate the **Normal Current Density** section.
- 4 In the  $J_n$  text field, type  $-j\_CE$ .

### *Normal Current Density 3*

- 1 In the **Physics** toolbar, click  **Boundaries** and choose **Normal Current Density**.
- 2 Select Boundary 15 only.
- 3 In the **Settings** window for **Normal Current Density**, locate the **Normal Current Density** section.
- 4 In the  $J_n$  text field, type  $1e-3 * j\_CE$ .

## HEAT TRANSFER IN SOLIDS (HT)

In the **Model Builder** window, under **Component 1 (comp1)** click **Heat Transfer in Solids (ht)**.

### *Heat Flux 1*

- 1 In the **Physics** toolbar, click  **Boundaries** and choose **Heat Flux**.
- 2 In the **Settings** window for **Heat Flux**, locate the **Boundary Selection** section.
- 3 From the **Selection** list, choose **All boundaries**.
- 4 Locate the **Heat Flux** section. From the **Flux type** list, choose **Convective heat flux**.

5 In the  $h$  text field, type  $h\_coeff$ .

#### *Boundary Heat Source I*

- 1 In the **Physics** toolbar, click  **Boundaries** and choose **Boundary Heat Source**.
- 2 In the **Settings** window for **Boundary Heat Source**, locate the **Boundary Selection** section.
- 3 From the **Selection** list, choose **Transistor Chip**.
- 4 Locate the **Boundary Heat Source** section. In the  $Q_b$  text field, type  $Q\_h$ .

#### **MESH I**

In the **Model Builder** window, under **Component I (comp1)** right-click **Mesh I** and choose **Build All**.

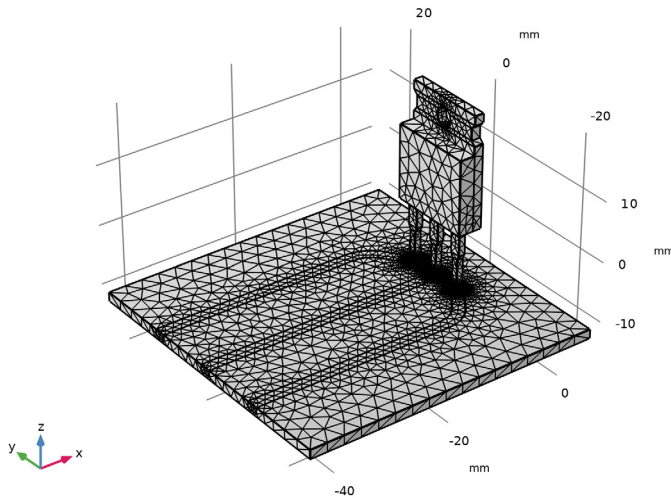

#### **STUDY I**

In the **Study** toolbar, click  **Compute**.

#### **RESULTS**

##### *Electric Potential (ec)*



In the **Electric Potential (ec)** toolbar, click  **Plot**.

##### *Temperature (ht)*

The third default plot shows the temperature. Add an arrow plot of the total heat flux.

- 1 In the **Model Builder** window, click **Temperature (ht)**.

### Arrow Surface 1

- 1 In the **Temperature (ht)** toolbar, click  **Arrow Surface**.
- 2 In the **Settings** window for **Arrow Surface**, click **Replace Expression** in the upper-right corner of the **Expression** section. From the menu, choose **Component 1 (comp1) > Heat Transfer in Solids > Domain fluxes > ht.tfluxx,...,ht.tfluxz - Total heat flux**.
- 3 Locate the **Arrow Positioning** section. In the **Number of arrows** text field, type 5e3.
- 4 Locate the **Coloring and Style** section. From the **Color** list, choose **Black**.
- 5 In the **Temperature (ht)** toolbar, click  **Plot**.
- 6 Click the  **Zoom In** button in the **Graphics** toolbar.

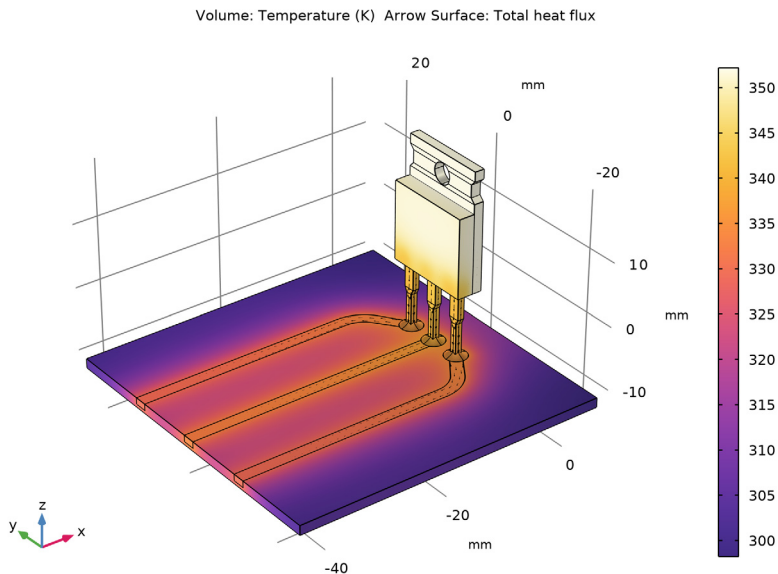

- 7 Click the  **Zoom Extents** button in the **Graphics** toolbar.

Finally, reproduce the plot in [Figure 3](#) by following the steps outlined below.

### Temperature along Copper Routes

- 1 In the **Results** toolbar, click  **ID Plot Group**.
- 2 In the **Settings** window for **ID Plot Group**, type **Temperature along Copper Routes** in the **Label** text field.

### Line Graph 1

- 1 In the **Temperature along Copper Routes** toolbar, click  **Line Graph**.

- 2 Select Edges 28, 41, 50, 59, and 65 only.
- 3 In the **Settings** window for **Line Graph**, click **Replace Expression** in the upper-right corner of the **y-Axis Data** section. From the menu, choose **Component I (comp1) > Heat Transfer in Solids > Temperature > T - Temperature - K**.
- 4 Locate the **x-Axis Data** section. From the **Parameter** list, choose **Reversed arc length**.
- 5 Click to expand the **Legends** section. Select the **Show legends** checkbox.
- 6 From the **Legends** list, choose **Manual**.
- 7 In the table, enter the following settings:

Legends
Base

- 8 In the **Temperature along Copper Routes** toolbar, click  **Plot**.

#### *Line Graph 2*

- 1 Right-click **Line Graph 1** and choose **Duplicate**.
- 2 In the **Settings** window for **Line Graph**, locate the **Selection** section.
- 3 Click to select the  **Activate Selection** toggle button.
- 4 Select Edges 14, 38, 47, 56, and 62 only.
- 5 Locate the **Legends** section. In the table, enter the following settings:

Legends
Collector

- 6 In the **Temperature along Copper Routes** toolbar, click  **Plot**.

#### *Temperature along Copper Routes*

- 1 In the **Model Builder** window, click **Temperature along Copper Routes**.
- 2 In the **Settings** window for **ID Plot Group**, click to expand the **Title** section.
- 3 From the **Title type** list, choose **None**.
- 4 Locate the **Plot Settings** section.
- 5 Select the **x-axis label** checkbox. In the associated text field, type Distance from connector (mm).
- 6 In the **Temperature along Copper Routes** toolbar, click  **Plot**.

## Geometry Modeling Instructions

---

If you want to create the geometry yourself, follow these steps.

### GEOMETRY 1

- 1 In the **Model Builder** window, under **Component 1 (comp1)** click **Geometry 1**.
- 2 In the **Settings** window for **Geometry**, locate the **Units** section.
- 3 From the **Length unit** list, choose **mm**.

### Block 1 (blk1)

- 1 In the **Geometry** toolbar, click  **Block**.
- 2 In the **Settings** window for **Block**, locate the **Size and Shape** section.
- 3 In the **Width** text field, type 50.
- 4 In the **Depth** text field, type 50.
- 5 In the **Height** text field, type 1.5.
- 6 Locate the **Position** section. In the **x** text field, type -44.
- 7 In the **y** text field, type -25.
- 8 In the **z** text field, type -12.

### Work Plane 1 (wp1)

- 1 In the **Geometry** toolbar, click  **Work Plane**.
- 2 In the **Settings** window for **Work Plane**, locate the **Plane Definition** section.
- 3 In the **z-coordinate** text field, type -10.5.

### Work Plane 1 (wp1) > Plane Geometry

In the **Model Builder** window, click **Plane Geometry**.

### Work Plane 1 (wp1) > Rectangle 1 (r1)

- 1 In the **Work Plane** toolbar, click  **Rectangle**.
- 2 In the **Settings** window for **Rectangle**, locate the **Size and Shape** section.
- 3 In the **Width** text field, type 34.
- 4 In the **Height** text field, type 2.
- 5 Locate the **Position** section. In the **xw** text field, type -44.
- 6 In the **yw** text field, type 10.5.

### Work Plane 1 (wp1) > Circle 1 (c1)

- 1 In the **Work Plane** toolbar, click  **Circle**.

- 2 In the **Settings** window for **Circle**, locate the **Size and Shape** section.
- 3 In the **Sector angle** text field, type 180.
- 4 In the **Radius** text field, type 6.5.
- 5 Locate the **Position** section. In the **xw** text field, type -10.
- 6 In the **yw** text field, type 6.
- 7 Locate the **Rotation Angle** section. In the **Rotation** text field, type -45.
- 8 Click to expand the **Layers** section. In the table, enter the following settings:



Layer name	Thickness (mm)
Layer 1	2

*Work Plane 1 (wp1) > Circle 2 (c2)*



- 1 In the **Work Plane** toolbar, click  **Circle**.
- 2 In the **Settings** window for **Circle**, locate the **Size and Shape** section.
- 3 In the **Radius** text field, type 1.75.
- 4 Locate the **Position** section. In the **xw** text field, type -2.5.
- 5 In the **yw** text field, type 5.
- 6 Locate the **Layers** section. In the table, enter the following settings:

Layer name	Thickness (mm)
Layer 1	0.85

*Work Plane 1 (wp1) > Tangent 1 (tan1)*

- 1 In the **Work Plane** toolbar, click  **Tangent**.
- 2 On the object **c1**, select Boundary 9 only.
- 3 In the **Settings** window for **Tangent**, locate the **Tangent** section.
- 4 Click to select the  **Activate Selection** toggle button for **Second edge to tangent**.
- 5 On the object **c2**, select Boundary 11 only.
- 6 In the tree, select **c2**.

*Work Plane 1 (wp1) > Tangent 2 (tan2)*

- 1 In the **Work Plane** toolbar, click  **Tangent**.
- 2 On the object **c1**, select Boundary 8 only.
- 3 In the **Settings** window for **Tangent**, locate the **Tangent** section.
- 4 Click to select the  **Activate Selection** toggle button for **Second edge to tangent**.

5 On the object **c2**, select Boundary 7 only.

6 In the tree, select **c2**.

*Work Plane 1 (wp1) > Convert to Curve 1 (ccur1)*

1 In the **Work Plane** toolbar, click  **Conversions** and choose **Convert to Curve**.

2 Click in the **Graphics** window and then press Ctrl+A to select all objects.

3 In the **Settings** window for **Convert to Curve**, click  **Build Selected**.

*Work Plane 1 (wp1) > Delete Entities 1 (dell)*

1 In the **Work Plane** toolbar, click  **Delete**.

2 In the **Settings** window for **Delete Entities**, locate the **Entities or Objects to Delete** section.

3 From the **Geometric entity level** list, choose **Boundary**.

4 On the object **ccur1**, select Boundaries 5, 7, 8, 10, 27, 30, and 32 only.

*Work Plane 1 (wp1) > Convert to Solid 1 (csoll)*

1 In the **Work Plane** toolbar, click  **Conversions** and choose **Convert to Solid**.

2 Select the object **dell** only.

*Work Plane 1 (wp1) > Union 1 (uni1)*

1 In the **Work Plane** toolbar, click  **Booleans and Partitions** and choose **Union**.

2 Select the object **csoll** only.

3 In the **Settings** window for **Union**, locate the **Union** section.

4 Clear the **Keep interior boundaries** checkbox.

*Plane Geometry*

1 In the **Model Builder** window, collapse the **Component 1 (comp1) > Geometry 1 > Work Plane 1 (wp1) > Plane Geometry** node.

2 In the **Model Builder** window, click **Plane Geometry**.

*Work Plane 1 (wp1) > Rectangle 2 (r2)*

1 In the **Work Plane** toolbar, click  **Rectangle**.

2 In the **Settings** window for **Rectangle**, locate the **Size and Shape** section.

3 In the **Width** text field, type 40.5.

4 In the **Height** text field, type 2.

5 Locate the **Position** section. In the **xw** text field, type -44.

6 In the **yw** text field, type -1.

*Work Plane 1 (wp1) > Circle 3 (c3)*

- 1 In the **Work Plane** toolbar, click  **Circle**.
- 2 In the **Settings** window for **Circle**, locate the **Size and Shape** section.
- 3 In the **Radius** text field, type 1.75.
- 4 Locate the **Position** section. In the **xw** text field, type -2.5.

*Work Plane 1 (wp1) > Union 2 (uni2)*

- 1 In the **Work Plane** toolbar, click  **Booleans and Partitions** and choose **Union**.
- 2 Select the objects **c3** and **r2** only.
- 3 In the **Settings** window for **Union**, locate the **Union** section.
- 4 Clear the **Keep interior boundaries** checkbox.

*Work Plane 1 (wp1) > Mirror 1 (mir1)*

- 1 In the **Work Plane** toolbar, click  **Transforms** and choose **Mirror**.
- 2 Select the object **uni1** only.
- 3 In the **Settings** window for **Mirror**, locate the **Input** section.
- 4 Select the **Keep input objects** checkbox.
- 5 Locate the **Normal Vector to Line of Reflection** section. In the **xw** text field, type 0.
- 6 In the **yw** text field, type 1.

*Extrude 1 (ext1)*

- 1 In the **Model Builder** window, under **Component 1 (comp1) > Geometry 1** right-click **Work Plane 1 (wp1)** and choose **Extrude**.
- 2 In the **Settings** window for **Extrude**, locate the **Distances** section.
- 3 Select the **Reverse direction** checkbox.

*Block 2 (blk2)*

- 1 In the **Geometry** toolbar, click  **Block**.
- 2 In the **Settings** window for **Block**, locate the **Size and Shape** section.
- 3 In the **Height** text field, type 9.
- 4 Locate the **Position** section. In the **x** text field, type -3.
- 5 In the **y** text field, type 4.5.
- 6 In the **z** text field, type -14.05.

*Block 3 (blk3)*

- 1 In the **Geometry** toolbar, click  **Block**.

- 2 In the **Settings** window for **Block**, locate the **Size and Shape** section.
- 3 In the **Depth** text field, type 1.75.
- 4 In the **Height** text field, type 6.
- 5 Locate the **Position** section. In the **x** text field, type -3.
- 6 In the **y** text field, type 4.125.
- 7 In the **z** text field, type -4.25.

*Hexahedron 1 (hex1)*

- 1 In the **Geometry** toolbar, click  **More Primitives** and choose **Hexahedron**.
- 2 In the **Settings** window for **Hexahedron**, locate the **Vertices** section.
- 3 In row **1**, set **x** to -3.
- 4 In row **1**, set **y** to 4.5.
- 5 In row **1**, set **z** to -5.05.
- 6 In row **2**, set **z** to -5.05.
- 7 In row **3**, set **z** to -5.05.
- 8 In row **4**, set **z** to -5.05.
- 9 In row **5**, set **z** to -4.25.
- 10 In row **6**, set **z** to -4.25.
- 11 In row **7**, set **z** to -4.25.
- 12 In row **8**, set **z** to -4.25.
- 13 In row **2**, set **y** to 4.5.
- 14 In row **3**, set **y** to 5.5.
- 15 In row **4**, set **y** to 5.5.
- 16 In row **5**, set **y** to 4.125.
- 17 In row **6**, set **y** to 4.125.
- 18 In row **7**, set **y** to 5.875.
- 19 In row **8**, set **y** to 5.875.
- 20 In row **2**, set **x** to -2.
- 21 In row **3**, set **x** to -2.
- 22 In row **4**, set **x** to -3.
- 23 In row **5**, set **x** to -3.
- 24 In row **6**, set **x** to -2.

**25** In row **7**, set **x** to -2.

**26** In row **8**, set **x** to -3.

#### *Union 1 (uni1)*

**1** In the **Geometry** toolbar, click  **Booleans and Partitions** and choose **Union**.

**2** Select the objects **blk2**, **blk3**, and **hex1** only.

**3** In the **Settings** window for **Union**, locate the **Union** section.

**4** Clear the **Keep interior boundaries** checkbox.

#### *Block 4 (blk4)*

**1** In the **Geometry** toolbar, click  **Block**.

**2** In the **Settings** window for **Block**, locate the **Size and Shape** section.

**3** In the **Width** text field, type 2.5.

**4** In the **Depth** text field, type 14.

**5** In the **Height** text field, type 12.5.

**6** Locate the **Position** section. In the **x** text field, type -4.

**7** In the **y** text field, type -7.

#### *Block 5 (blk5)*

**1** In the **Geometry** toolbar, click  **Block**.

**2** In the **Settings** window for **Block**, locate the **Size and Shape** section.

**3** In the **Width** text field, type 1.5.

**4** In the **Depth** text field, type 14.

**5** In the **Height** text field, type 14.

**6** Locate the **Position** section. In the **x** text field, type -1.5.

**7** In the **y** text field, type -7.

#### *Block 6 (blk6)*

**1** In the **Geometry** toolbar, click  **Block**.

**2** In the **Settings** window for **Block**, locate the **Size and Shape** section.

**3** In the **Width** text field, type 1.5.

**4** In the **Depth** text field, type 12.5.

**5** In the **Height** text field, type 2.

**6** Locate the **Position** section. In the **x** text field, type -1.5.

**7** In the **y** text field, type -6.25.

8 In the **z** text field, type 14.75.

*Block 7 (blk7)*

- 1 In the **Geometry** toolbar, click  **Block**.
- 2 In the **Settings** window for **Block**, locate the **Size and Shape** section.
- 3 In the **Width** text field, type 1.5.
- 4 In the **Depth** text field, type 14.
- 5 In the **Height** text field, type 1.5.
- 6 Locate the **Position** section. In the **x** text field, type -1.5.
- 7 In the **y** text field, type -7.
- 8 In the **z** text field, type 17.5.

*Hexahedron 2 (hex2)*

- 1 In the **Geometry** toolbar, click  **More Primitives** and choose **Hexahedron**.
- 2 In the **Settings** window for **Hexahedron**, locate the **Vertices** section.
- 3 In row **1**, set **x** to -1.5.
- 4 In row **1**, set **y** to -7.
- 5 In row **1**, set **z** to 14.
- 6 In row **2**, set **y** to -7.
- 7 In row **2**, set **z** to 14.
- 8 In row **3**, set **y** to 7.
- 9 In row **3**, set **z** to 14.
- 10 In row **3**, set **x** to 0.
- 11 In row **4**, set **x** to -1.5.
- 12 In row **4**, set **y** to 7.
- 13 In row **4**, set **z** to 14.
- 14 In row **5**, set **x** to -1.5.
- 15 In row **5**, set **y** to -6.25.
- 16 In row **5**, set **z** to 14.75.
- 17 In row **6**, set **y** to -6.25.
- 18 In row **6**, set **z** to 14.75.
- 19 In row **7**, set **x** to 0.
- 20 In row **7**, set **y** to 6.25.

**21** In row **7**, set **z** to 14.75.

**22** In row **8**, set **x** to -1.5.

**23** In row **8**, set **y** to 6.25.

**24** In row **8**, set **z** to 14.75.

#### *Mirror 1 (mir1)*

**1** In the **Geometry** toolbar, click  **Transforms** and choose **Mirror**.

**2** Select the object **hex2** only.

**3** In the **Settings** window for **Mirror**, locate the **Input** section.

**4** Select the **Keep input objects** checkbox.

**5** Locate the **Point on Plane of Reflection** section. In the **z** text field, type 15.75.

#### *Union 2 (uni2)*

**1** In the **Geometry** toolbar, click  **Booleans and Partitions** and choose **Union**.

**2** Select the objects **blk5**, **blk6**, **blk7**, **hex2**, and **mir1** only.

**3** In the **Settings** window for **Union**, locate the **Union** section.

**4** Clear the **Keep interior boundaries** checkbox.

#### *Cylinder 1 (cyl1)*

**1** In the **Geometry** toolbar, click  **Cylinder**.

**2** In the **Settings** window for **Cylinder**, locate the **Size and Shape** section.

**3** In the **Radius** text field, type 1.65.

**4** In the **Height** text field, type 1.5.

**5** Locate the **Position** section. In the **x** text field, type -1.5.

**6** In the **z** text field, type 15.75.

**7** Locate the **Axis** section. From the **Axis type** list, choose **x-axis**.

#### *Difference 1 (dif1)*

**1** In the **Geometry** toolbar, click  **Booleans and Partitions** and choose **Difference**.

**2** Select the object **uni2** only.

**3** In the **Settings** window for **Difference**, locate the **Difference** section.

**4** Click to select the  **Activate Selection** toggle button for **Objects to subtract**.

**5** Select the object **cyl1** only.

#### *Transistor Chip*

**1** In the **Geometry** toolbar, click  **Work Plane**.

- 2 In the **Settings** window for **Work Plane**, type Transistor Chip in the **Label** text field.
- 3 Locate the **Plane Definition** section. From the **Plane type** list, choose **Face parallel**.
- 4 On the object **dif1**, select Boundary 1 only.

*Transistor Chip (wp2) > Plane Geometry*

In the **Model Builder** window, click **Plane Geometry**.

*Transistor Chip (wp2) > Square 1 (sq1)*

- 1 In the **Work Plane** toolbar, click  **Square**.
- 2 In the **Settings** window for **Square**, locate the **Size** section.
- 3 In the **Side length** text field, type 3.
- 4 Locate the **Position** section. In the **xw** text field, type -1.5.

*Transistor Chip (wp2)*

- 1 In the **Model Builder** window, under **Component 1 (comp1) > Geometry 1** click **Transistor Chip (wp2)**.
- 2 In the **Settings** window for **Work Plane**, locate the **Selections of Resulting Entities** section.
- 3 Select the **Resulting objects selection** checkbox.

*Work Plane 3 (wp3)*

- 1 In the **Geometry** toolbar, click  **Work Plane**.
- 2 In the **Settings** window for **Work Plane**, locate the **Plane Definition** section.
- 3 From the **Plane** list, choose **yz-plane**.
- 4 In the **x-coordinate** text field, type -2.5.

*Work Plane 3 (wp3) > Plane Geometry*

In the **Model Builder** window, click **Plane Geometry**.

*Work Plane 3 (wp3) > Polygon 1 (pol1)*

- 1 In the **Work Plane** toolbar, click  **Polygon**.
- 2 In the **Settings** window for **Polygon**, locate the **Object Type** section.
- 3 From the **Type** list, choose **Open curve**.
- 4 Locate the **Coordinates** section. From the **Data source** list, choose **Vectors**.
- 5 In the **xw** text field, type 5.5 5.5 5.9 5.9 6.75.
- 6 In the **yw** text field, type -9.7 -12 -12 -10.5 -10.5.

*Work Plane 3 (wp3) > Quadratic Bézier 1 (qb1)*

- 1 In the **Work Plane** toolbar, click  **More Primitives** and choose **Quadratic Bézier**.

- 2 In the **Settings** window for **Quadratic Bézier**, locate the **Control Points** section.
- 3 In row **1**, set **xw** to 6.75.
- 4 In row **2**, set **xw** to 5.5.
- 5 In row **3**, set **xw** to 5.5.
- 6 In row **1**, set **yw** to -10.5.
- 7 In row **2**, set **yw** to -10.3.
- 8 In row **3**, set **yw** to -9.7.
- 9 Locate the **Weights** section. In the **2** text field, type  $0.5/\sqrt{2}$ .

*Work Plane 3 (wp3) > Convert to Solid 1 (csol1)*

- 1 In the **Work Plane** toolbar, click  **Conversions** and choose **Convert to Solid**.
- 2 Click in the **Graphics** window and then press Ctrl+A to select both objects.

*Revolve 1 (rev1)*

- 1 In the **Model Builder** window, under **Component 1 (comp1) > Geometry 1** right-click **Work Plane 3 (wp3)** and choose **Revolve**.
- 2 In the **Settings** window for **Revolve**, locate the **Revolution Angles** section.
- 3 Clear the **Keep original faces** checkbox.
- 4 Locate the **Revolution Axis** section. From the **Axis type** list, choose **3D**.
- 5 Find the **Point on the revolution axis** subsection. In the **x** text field, type -2.5.
- 6 In the **y** text field, type 5.
- 7 In the **z** text field, type -5.05.
- 8 Find the **Direction of revolution axis** subsection. In the **y** text field, type 0.
- 9 In the **z** text field, type 1.



*Union 3 (uni3)*

- 1 In the **Geometry** toolbar, click  **Booleans and Partitions** and choose **Union**.
- 2 Select the objects **rev1** and **uni1** only.



*Array 1 (arr1)*

- 1 In the **Geometry** toolbar, click  **Transforms** and choose **Array**.
- 2 Select the object **uni3** only.
- 3 In the **Settings** window for **Array**, locate the **Size** section.
- 4 In the **y size** text field, type 3.
- 5 Locate the **Displacement** section. In the **y** text field, type -5.

*Form Composite Domains 1 (cmd1)*

- 1 In the **Geometry** toolbar, click  **Virtual Operations** and choose **Form Composite Domains**.
- 2 Click the  **Wireframe Rendering** button in the **Graphics** toolbar.
- 3 On the object **fin**, select Domain 39 only.
- 4 On the object **fin**, select Domains 15, 16, 26, 27, 30, 37–47, and 60–65 only.
- 5 On the object **fin**, select Domains 11, 12, 15, 16, 26–47, and 54–65 only.
- 6 On the object **fin**, select Domains 15–65 only.

*Form Composite Domains 2 (cmd2)*

- 1 In the **Geometry** toolbar, click  **Virtual Operations** and choose **Form Composite Domains**.
- 2 Click the  **Select Box** button in the **Graphics** toolbar.
- 3 On the object **cmd1**, select Domains 5–7 and 9–14 only.