



Model created in COMSOL Multiphysics 6.4

# Thermal Modeling of a Microchannel Heat Sink

## Introduction

---

This example models a microchannel heat sink mounted on an active electronic component. The model geometry is based on the papers of Pak and others (Ref. 1) and by Jang and others (Ref. 2).

Thermal management has become a critical aspect of today's electronic systems, which often include many high-performance circuits that dissipate large amounts of heat. Many of these components require efficient cooling to prevent overheating. Some of these components, such as processors, require a heat sink with cooling fins that are exposed to forced air from a fan. The microchannel heat sink featured in this tutorial has manifolds that work as flow dividers to improve its cooling performance (see Figure 1).

This tutorial analyzes the temperature field in the air around the heat sink, inside the aluminum heat sink and the heat source. The governing energy transport is convection and conduction in the air domain, while the aluminum has pure conduction. A thermal contact resistance at the interface between the heat sink and the electronic component is also accounted for.

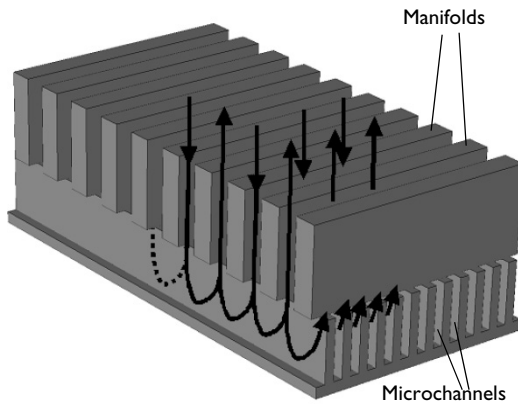

Figure 1: Microchannel heat sink with manifolds.

## Model Definition

---

The model geometry consists of three domains: the electronic component, the aluminum heat sink, and the cooling air. Due to symmetry considerations, it is sufficient to model only a small element of the entire geometry as shown in Figure 2. Symmetry boundary

conditions would then complete the model definition. In particular, the surfaces labeled *Inlet* and *Outlet* represent one quarter of the actual inlet and outlet.

This simulation uses the Conjugate Heat Transfer interface to solve for the coupled flow field in the air domain and the temperature field in the entire geometry.

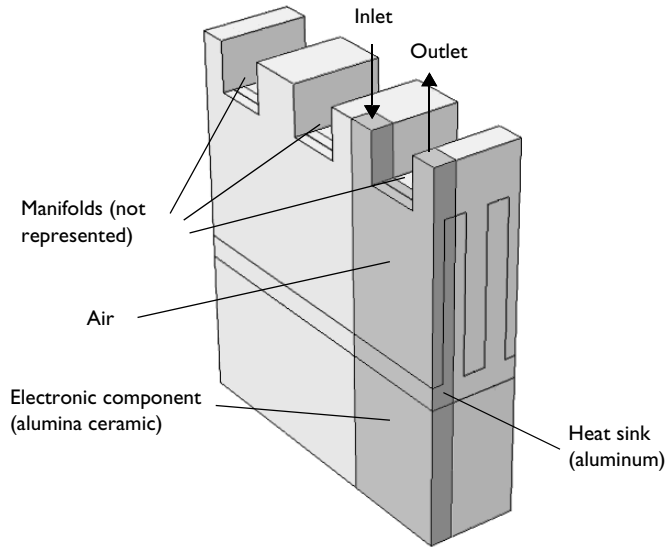

*Figure 2: Model geometry with symmetries.*

### **BOUNDARY CONDITIONS**

A laminar inflow profile with an average velocity of 0.85 m/s at the inlet is used together with a prescribed temperature of 22°C. At the outlet the heat leaves through convection.

At the interface between the heat sink and electronic component, the Thermal Contact boundary condition is used. Thermal contact resistance is an important factor in the design of electronics cooling because it can significantly reduce a heat sink cooling performance. For more information about the thermal contact feature and its settings, read the theory section about the Thermal Contact feature in the *Heat Transfer Module User's Guide*.

The surfaces of the heat sink and the ceramic heat source are not in perfect contact because of their roughness; air fills the gaps between the surfaces. Modeling the interface with the geometry of the rough surfaces would require a very dense mesh. An alternative, more practical, way of modeling the interface is to define a nonideal thermal contact, that is representative for the interface. In this case, the joint conductivity is the sum of the gap conductance  $h_g$  and the conductivity due to the contact surface properties  $h_c$ . The latter

depends on the contact pressure, surface roughness and microhardness and is described by the Cooper–Mikic–Yovanovich correlation (Ref. 3).

*Results and Discussion*

Figure 3 shows the velocity profile via magnitude field and arrow plot in the air domain.

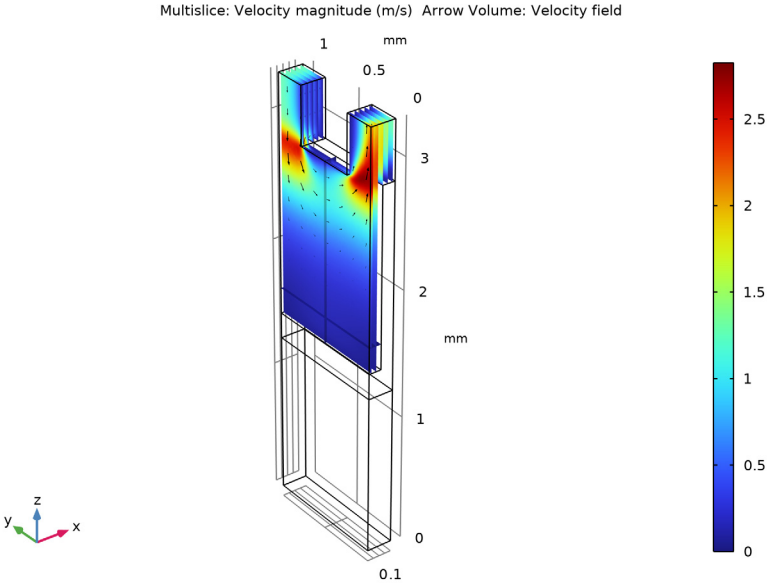

Figure 3: Velocity profile in the air domain.

Figure 4 shows the resulting temperature field in the heat sink with velocity streamlines in the air domain.

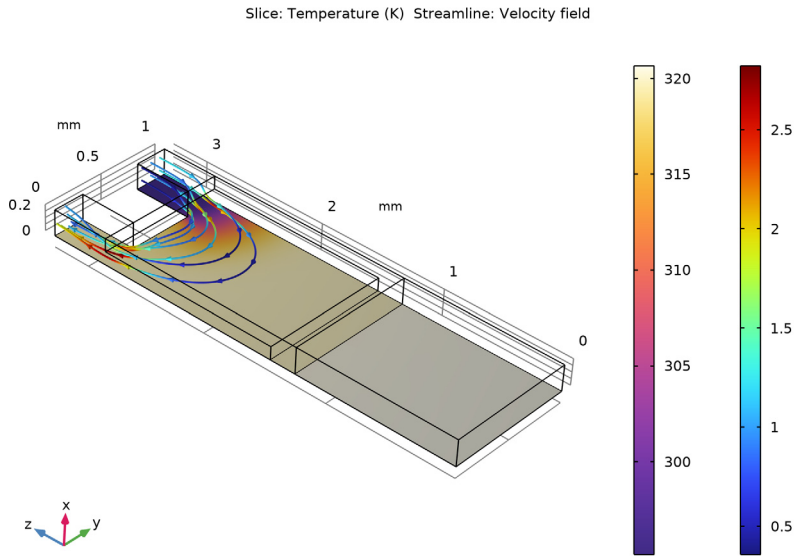

Figure 4: Temperature field and velocity streamlines in the heat sink.

At the ceramic-aluminum imperfect contact region, a small temperature jump appears due to light contact pressure. The average jump evaluates to 0.7 K and the joint conductance of the interface is about  $8900 \text{ W}/(\text{m}^2 \cdot \text{K})$ .

## References

1. B.C. Pak and others, “Forced Air Cooling by Using Manifold Microchannel Heat Sinks,” *Advances in Electronic Packaging*, ASME-EEP, vol. 19, no. 2, pp. 1837–1842, 1997.
2. S.P. Jang, S.J. Kim and K.W. Paik, “Experimental Investigation of Thermal Characteristics for a Microchannel Heat Sink Subject to an Impinging Jet, Using a Micro-Thermal Sensor Array,” *Sensors and Actuators A: Physical*, vol. 105, no. 2, pp. 211–224, 2003.
3. M.M. Yovanovich and E.E. Marotta, “Thermal Spreading and Contact Resistance,” *Heat Transfer Handbook*, A. Bejan and A.D. Kraus eds., John Wiley & Sons, 2003.

---

**Application Library path:** Heat\_Transfer\_Module/  
Power\_Electronics\_and\_Electronic\_Cooling/microchannel\_heat\_sink

---

### *Modeling Instructions*



---

From the **File** menu, choose **New**.

#### **NEW**

In the **New** window, click  **Model Wizard**.

#### **MODEL WIZARD**

- 1 In the **Model Wizard** window, click  **3D**.
- 2 In the **Select Physics** tree, select **Heat Transfer** > **Conjugate Heat Transfer** > **Laminar Flow**.
- 3 Click **Add**.
- 4 Click  **Study**.
- 5 In the **Select Study** tree, select **General Studies** > **Stationary**.
- 6 Click  **Done**.

#### **GEOMETRY I**

- 1 In the **Model Builder** window, under **Component 1 (comp1)** click **Geometry 1**.
- 2 In the **Settings** window for **Geometry**, locate the **Units** section.
- 3 From the **Length unit** list, choose **mm**.

#### *Block 1 (blk1)*

- 1 In the **Geometry** toolbar, click  **Block**.
- 2 In the **Settings** window for **Block**, locate the **Size and Shape** section.
- 3 In the **Width** text field, type 0.2.
- 4 In the **Height** text field, type 2.85.
- 5 Click to expand the **Layers** section. In the table, enter the following settings:



---

Layer name	Thickness (mm)
Layer 1	1.25



---

- 6 Click  **Build Selected**.



*Block 2 (blk2)*

- 1 In the **Geometry** toolbar, click  **Block**.
- 2 In the **Settings** window for **Block**, locate the **Size and Shape** section.
- 3 In the **Width** text field, type 0.1.
- 4 In the **Height** text field, type 1.4.
- 5 Locate the **Position** section. In the **z** text field, type 1.45.
- 6 Click  **Build Selected**.



*Difference 1 (dif1)*

- 1 In the **Geometry** toolbar, click  **Booleans and Partitions** and choose **Difference**.
- 2 Select the object **blk1** only.
- 3 In the **Settings** window for **Difference**, locate the **Difference** section.
- 4 Click to select the  **Activate Selection** toggle button for **Objects to subtract**.
- 5 Select the object **blk2** only.
- 6 Click  **Build Selected**.

*Block 3 (blk3)*

- 1 In the **Geometry** toolbar, click  **Block**.
- 2 In the **Settings** window for **Block**, locate the **Size and Shape** section.
- 3 In the **Width** text field, type 0.2.
- 4 In the **Height** text field, type 1.85.
- 5 Locate the **Position** section. In the **z** text field, type 1.45.
- 6 Click  **Build Selected**.

*Difference 2 (dif2)*





- 1 In the **Geometry** toolbar, click  **Booleans and Partitions** and choose **Difference**.
- 2 Select the object **blk3** only.
- 3 In the **Settings** window for **Difference**, locate the **Difference** section.
- 4 Click to select the  **Activate Selection** toggle button for **Objects to subtract**.
- 5 Select the object **dif1** only.
- 6 Select the **Keep objects to subtract** checkbox.
- 7 Click  **Build Selected**.

*Block 4 (blk4)*

- 1 In the **Geometry** toolbar, click  **Block**.

- 2 In the **Settings** window for **Block**, locate the **Size and Shape** section.
- 3 In the **Width** text field, type 0.2.
- 4 In the **Depth** text field, type 0.5.
- 5 In the **Height** text field, type 0.45.
- 6 Locate the **Position** section. In the **y** text field, type 0.25.
- 7 In the **z** text field, type 2.85.
- 8 Click  **Build Selected**.

#### *Difference 3 (dif3)*

- 1 In the **Geometry** toolbar, click  **Booleans and Partitions** and choose **Difference**.
- 2 Select the object **dif2** only.
- 3 In the **Settings** window for **Difference**, locate the **Difference** section.
- 4 Click to select the  **Activate Selection** toggle button for **Objects to subtract**.
- 5 Select the object **blk4** only.
- 6 In the **Geometry** toolbar, click  **Build All**.
- 7 Click the  **Zoom Extents** button in the **Graphics** toolbar.

Define the parameters for the heat production and the contact pressure between the aluminum heat sink and the ceramic domain.

## **GLOBAL DEFINITIONS**

### *Parameters 1*

- 1 In the **Model Builder** window, under **Global Definitions** click **Parameters 1**.
- 2 In the **Settings** window for **Parameters**, locate the **Parameters** section.
- 3 In the table, enter the following settings:

<b>Name</b>	<b>Expression</b>	<b>Value</b>	<b>Description</b>
Q_in	5[W/cm^3]	5E6 W/m <sup>3</sup>	Heat production in ceramic
P_c	0.35[MPa]	3.5E5 Pa	Contact pressure

Select the materials from the built-in material library.

## **ADD MATERIAL**

- 1 In the **Home** toolbar, click  **Add Material** to open the **Add Material** window.
- 2 Go to the **Add Material** window.
- 3 In the tree, select **Built-in > Air**.

- 4 Click the **Add to Component** button in the window toolbar.
- 5 In the tree, select **Built-in > Alumina**.
- 6 Click the **Add to Component** button in the window toolbar.
- 7 In the tree, select **Built-in > Aluminum 6063-T83**.
- 8 Click the **Add to Component** button in the window toolbar.
- 9 In the **Home** toolbar, click  **Add Material** to close the **Add Material** window.

## MATERIALS

### *Alumina (mat2)*

Select Domain 1 only.

### *Aluminum 6063-T83 (mat3)*

- 1 In the **Model Builder** window, click **Aluminum 6063-T83 (mat3)**.
- 2 Select Domain 2 only.

## LAMINAR FLOW (SPF)

- 1 In the **Model Builder** window, under **Component 1 (comp1)** click **Laminar Flow (spf)**.
- 2 Select Domain 3 only.
- 3 In the **Settings** window for **Laminar Flow**, locate the **Domain Selection** section.
- 4 Click  **Create Selection**.
- 5 In the **Create Selection** dialog, type **Air** in the **Selection name** text field.
- 6 Click **OK**.

### *Inlet 1*

- 1 In the **Physics** toolbar, click  **Boundaries** and choose **Inlet**.
- 2 Select Boundary 14 only.
- 3 In the **Settings** window for **Inlet**, locate the **Boundary Condition** section.
- 4 From the list, choose **Fully developed flow**.
- 5 Locate the **Fully Developed Flow** section. In the  $U_{av}$  text field, type  $0.85 [m/s]$ .

### *Outlet 1*

- 1 In the **Physics** toolbar, click  **Boundaries** and choose **Outlet**.
- 2 Select Boundary 10 only.

### *Symmetry 1*

- 1 In the **Physics** toolbar, click  **Boundaries** and choose **Symmetry**.

- 2 Select Boundaries 7, 8, 17, 24, and 25 only.

## HEAT TRANSFER IN SOLIDS AND FLUIDS (HT)

### Fluid 1

- 1 In the **Model Builder** window, under **Component 1 (comp1) > Heat Transfer in Solids and Fluids (ht)** click **Fluid 1**.
- 2 In the **Settings** window for **Fluid**, locate the **Domain Selection** section.
- 3 From the **Selection** list, choose **Air**.

### Heat Source 1

- 1 In the **Physics** toolbar, click  **Domains** and choose **Heat Source**.
- 2 Select Domain 1 only.
- 3 In the **Settings** window for **Heat Source**, locate the **Heat Source** section.
- 4 In the  $Q_0$  text field, type  $Q_{in}$ .

### Inflow 1

- 1 In the **Physics** toolbar, click  **Boundaries** and choose **Inflow**.
- 2 Select Boundary 14 only.
- 3 In the **Settings** window for **Inflow**, locate the **Upstream Properties** section.
- 4 In the  $T_{ustr}$  text field, type  $22[\text{degC}]$ .

### Outflow 1

- 1 In the **Physics** toolbar, click  **Boundaries** and choose **Outflow**.
- 2 Select Boundary 10 only.

### Thermal Contact 1

- 1 In the **Physics** toolbar, click  **Boundaries** and choose **Thermal Contact**.
- 2 Select Boundary 6 only.
- 3 In the **Settings** window for **Thermal Contact**, locate the **Thermal Contact** section.
- 4 From the  $h_g$  list, choose **Parallel-plate gap gas conductance**.
- 5 Locate the **Contact Surface Properties** section. In the  $\sigma_{asp}$  text field, type  $1.5[\mu\text{m}]$ .
- 6 In the  $m_{asp}$  text field, type  $0.2$ .
- 7 In the  $p$  text field, type  $P_c$ .
- 8 In the  $H_c$  text field, type  $1[\text{GPa}]$ .
- 9 Click to expand the **Gap Properties** section. From the  $k_{gap}$  list, choose **User defined**.

### *Symmetry I*



- 1 In the **Physics** toolbar, click  **Boundaries** and choose **Symmetry**.
- 2 Select Boundaries 1, 2, 4, 5, 7, 8, 15–17, and 22–25 only.

### **MESH I**

The automatically generated mesh settings provide a good resolution for the fluid domains. In order to get a finer mesh in the solid domains, adjust the maximum element size for the solid domains.

- 1 In the **Model Builder** window, under **Component 1 (comp1)** right-click **Mesh I** and choose **Edit Physics-Induced Sequence**.

### *Size*

- 1 In the **Model Builder** window, under **Component 1 (comp1)** > **Mesh I** click **Size**.
- 2 In the **Settings** window for **Size**, locate the **Element Size Parameters** section.
- 3 In the **Maximum element size** text field, type 0.09.
- 4 Click  **Build All**.
- 5 In the **Home** toolbar, click  **Compute**.

### **RESULTS**

### *Velocity (spf)*

The second default plot shows the velocity field in the air domain (see [Figure 3](#)).

### *Multislice I*

- 1 In the **Model Builder** window, expand the **Velocity (spf)** node, then click **Multislice I**.
- 2 In the **Settings** window for **Multislice**, locate the **Multiphase Data** section.
- 3 Find the **x-planes** subsection. In the **Planes** text field, type 5.
- 4 In the **Velocity (spf)** toolbar, click  **Plot**.

### *Velocity (spf)*

In the **Velocity (spf)** toolbar, click  **Arrow Volume**.

### *Arrow Volume I*

- 1 In the **Settings** window for **Arrow Volume**, click **Replace Expression** in the upper-right corner of the **Expression** section. From the menu, choose **Component 1 (comp1)** > **Laminar Flow** > **Velocity and pressure** > **u,v,w - Velocity field**.
- 2 Locate the **Arrow Positioning** section. Find the **x grid points** subsection. In the **Points** text field, type 5.

- 3 Find the **z grid points** subsection. In the **Points** text field, type 20.
- 4 Locate the **Coloring and Style** section. From the **Color** list, choose **Black**.
- 5 In the **Velocity (spf)** toolbar, click  **Plot**.

Evaluate the temperature jump and the joint conductance at the contact interface.

#### *Temperature Jump and Joint Conductance*

- 1 In the **Results** toolbar, click  **More Derived Values** and choose **Average > Surface Average**.
- 2 In the **Settings** window for **Surface Average**, type Temperature Jump and Joint Conductance in the **Label** text field.
- 3 Select Boundary 6 only.
- 4 Locate the **Expressions** section. In the table, enter the following settings:



Expression	Unit	Description
up(T) - down(T)	K	Temperature jump
ht.tc1.hjoint	W/(m <sup>2</sup> *K)	Joint conductance

The up and down operators return the temperature on each side of the contact boundary.

- 5 Click  **Evaluate**.

The temperature jump at the interface is about 0.7 K, and the joint conductance is about 8900 W/(m<sup>2</sup>\*K).

#### **RESULT TEMPLATES**

- 1 In the **Results** toolbar, click  **Result Templates** to open the **Result Templates** window.
- 2 Go to the **Result Templates** window.
- 3 In the tree, select **Study 1/Solution 1 (sol1) > Heat Transfer in Solids and Fluids > Contact Temperature (ht)**.
- 4 Click the **Add Result Template** button in the window toolbar.
- 5 In the **Results** toolbar, click  **Result Templates** to close the **Result Templates** window.

To reproduce the plot shown in [Figure 4](#), follow the steps below.

#### **RESULTS**

##### *Volume 1*

- 1 In the **Model Builder** window, expand the **Results > Temperature (ht)** node.

2 Right-click **Volume 1** and choose **Delete**.

#### *Slice 1*

- 1 In the **Temperature (ht)** toolbar, click  **Slice**.
- 2 In the **Settings** window for **Slice**, click **Replace Expression** in the upper-right corner of the **Expression** section. From the menu, choose **Component 1 (comp1) > Heat Transfer in Solids and Fluids > Temperature > T - Temperature - K**.
- 3 Locate the **Plane Data** section. From the **Entry method** list, choose **Coordinates**.
- 4 Locate the **Coloring and Style** section. From the **Color table** list, choose **HeatCameraLight**.

#### *Temperature (ht)*

In the **Model Builder** window, click **Temperature (ht)**.

#### *Streamline 1*

- 1 In the **Temperature (ht)** toolbar, click  **Streamline**.
- 2 In the **Settings** window for **Streamline**, click **Replace Expression** in the upper-right corner of the **Expression** section. From the menu, choose **Component 1 (comp1) > Laminar Flow > Velocity and pressure > u,v,w - Velocity field**.
- 3 Select Boundary 14 only.
- 4 Locate the **Streamline Positioning** section. In the **Number** text field, type 6.
- 5 Locate the **Coloring and Style** section. Find the **Line style** subsection. From the **Type** list, choose **Tube**.
- 6 Select the **Radius scale factor** checkbox.
- 7 In the **Tube radius expression** text field, type 0.006.
- 8 Find the **Point style** subsection. From the **Type** list, choose **Arrow**.
- 9 Select the **Number of arrows** checkbox. In the associated text field, type 36.

#### *Color Expression 1*

- 1 In the **Temperature (ht)** toolbar, click  **Color Expression**.
- 2 In the **Settings** window for **Color Expression**, click **Replace Expression** in the upper-right corner of the **Expression** section. From the menu, choose **Component 1 (comp1) > Laminar Flow > Velocity and pressure > spf.U - Velocity magnitude - m/s**.

## **DEFINITIONS**

In the **Model Builder** window, expand the **Component 1 (comp1) > Definitions** node.

### Camera

- 1 In the **Model Builder** window, expand the **Component 1 (comp1) > Definitions > View 1** node, then click **Camera**.
- 2 In the **Settings** window for **Camera**, locate the **Camera** section.
- 3 In the **Zoom angle** text field, type 7.
- 4 Locate the **Position** section. In the **x** text field, type 11.
- 5 In the **y** text field, type -11.
- 6 In the **z** text field, type -8.
- 7 Locate the **Target** section. In the **x** text field, type 0.1.
- 8 In the **y** text field, type 0.50.
- 9 In the **z** text field, type 1.66.
- 10 Locate the **Up Vector** section. In the **x** text field, type 0.8.
- 11 In the **y** text field, type 0.4.
- 12 In the **z** text field, type 0.4.
- 13 Locate the **Center of Rotation** section. In the **z** text field, type 1.66.
- 14 Locate the **View Offset** section. In the **x** text field, type 0.25.
- 15 In the **y** text field, type -0.25.
- 16 Click  **Update**.

### RESULTS

#### Temperature (ht)

- 1 In the **Model Builder** window, under **Results** click **Temperature (ht)**.
- 2 In the **Settings** window for **3D Plot Group**, locate the **Plot Settings** section.
- 3 From the **View** list, choose **View 1**.
- 4 In the **Temperature (ht)** toolbar, click  **Plot**.