



Model created in COMSOL Multiphysics 6.4

Heat Sink

Introduction

This example is intended as a first introduction to simulations of fluid flow and conjugate heat transfer. An extension of the application that takes surface-to-surface radiation into account is also available; see [Heat Sink with Surface-to-Surface Radiation](#).

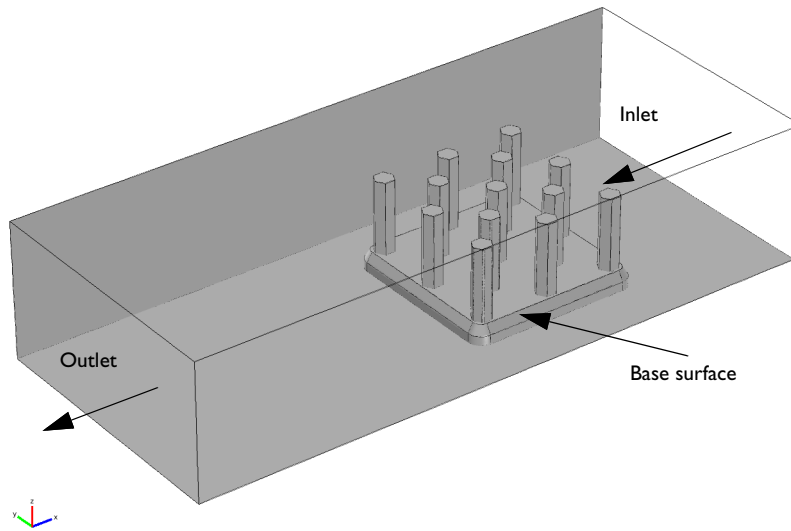

Figure 1: The application setup including channel and heat sink.

Model Definition

The modeled system consists of an aluminum heat sink for cooling of components in electronic circuits mounted inside a channel of rectangular cross section (see [Figure 1](#)).

Such a setup is used to measure the cooling capacity of heat sinks. Air enters the channel at the inlet and exits the channel at the outlet. The base surface of the heat sink receives a 1 W heat flux from an external heat source. All other external faces are thermally insulated.

The cooling capacity of the heat sink can be determined by monitoring the temperature of the base surface of the heat sink.

The model solves a thermal balance for the heat sink and the air flowing in the rectangular channel. Thermal energy is transported through conduction in the aluminum heat sink

and through conduction and convection in the cooling air. The temperature field is continuous across the internal surfaces between the heat sink and the air in the channel. The temperature is set at the inlet of the channel. The base of the heat sink receives a 1 W heat flux. The transport of thermal energy at the outlet is dominated by convection.

The flow field is obtained by solving one momentum balance for each space coordinate (x , y , and z) and a mass balance. The inlet velocity is defined by a parabolic velocity profile for fully developed laminar flow. At the outlet, the normal stress is equal the outlet pressure and the tangential stress is nullified. At all solid surfaces, the velocity is set to zero in all three spatial directions.

The thermal conductivity of air, the heat capacity of air, and the air density are all temperature-dependent material properties.

You can find all of the settings mentioned above in the predefined multiphysics coupling for Conjugate Heat Transfer in COMSOL Multiphysics. You also find the material properties, including their temperature dependence, in the Material Browser.

Results

In [Figure 2](#), the hot wake behind the heat sink visible in the plot is a sign of the convective cooling effects. The maximum temperature, reached at the heat sink base, is about 380 K.

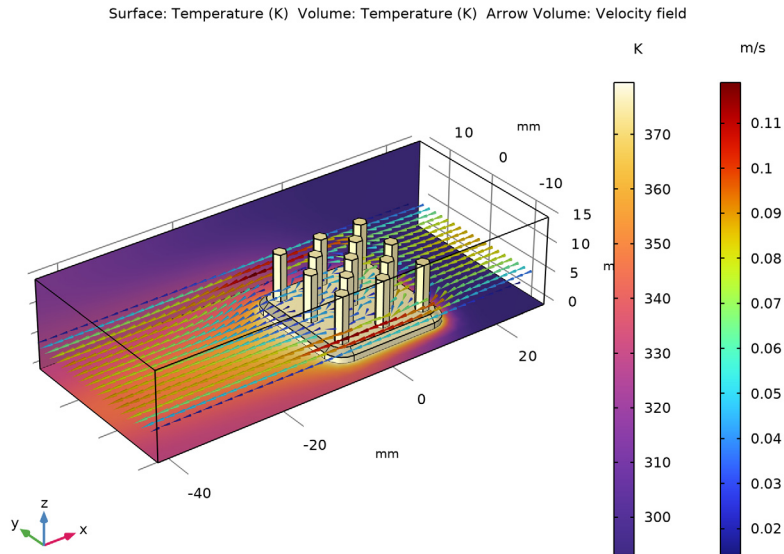



Figure 2: The surface plot shows the temperature field on the channel walls and the heat sink surface, while the arrow plot shows the flow velocity field around the heat sink.

Application Library path: Heat_Transfer_Module/Tutorials,
_Forced_and_Natural_Convection/heat_sink



Modeling Instructions

From the **File** menu, choose **New**.

NEW

In the **New** window, click  **Model Wizard**.

MODEL WIZARD

- 1 In the **Model Wizard** window, click  **3D**.
- 2 In the **Select Physics** tree, select **Heat Transfer > Conjugate Heat Transfer > Laminar Flow**.
- 3 Click **Add**.
- 4 Click  **Study**.
- 5 In the **Select Study** tree, select **General Studies > Stationary**.
- 6 Click  **Done**.

GEOMETRY I

Note that the **Geometry representation** must be set to **COMSOL kernel** to fit with the numbering of the boundaries used in these instructions.

The model geometry is available as a parameterized geometry sequence in a separate MPH file. If you want to create it from scratch yourself, you can follow the instructions in the [Geometry Modeling Instructions](#) section. Otherwise, insert the geometry sequence as follows:

- 1 In the **Geometry** toolbar, click **Insert Sequence** and choose **Insert Sequence**.
- 2 Browse to the model's Application Libraries folder and double-click the file `heat_sink_geom_sequence.mph`.

The application's Application Library folder is shown in the **Application Library path** section immediately before the current section. This path originates from the folder **applications** under the COMSOL Multiphysics installation folder.

- 3 In the **Geometry** toolbar, click  **Build All**.
- 4 Click the  **Zoom Extents** button in the **Graphics** toolbar.
To facilitate face selection in the next steps, use the **Wireframe rendering** option (skip this step if you followed the instructions in the appendix):
- 5 Click the  **Wireframe Rendering** button in the **Graphics** toolbar.

6 In the **Model Builder** window, under **Component 1 (comp1)** click **Geometry 1**.

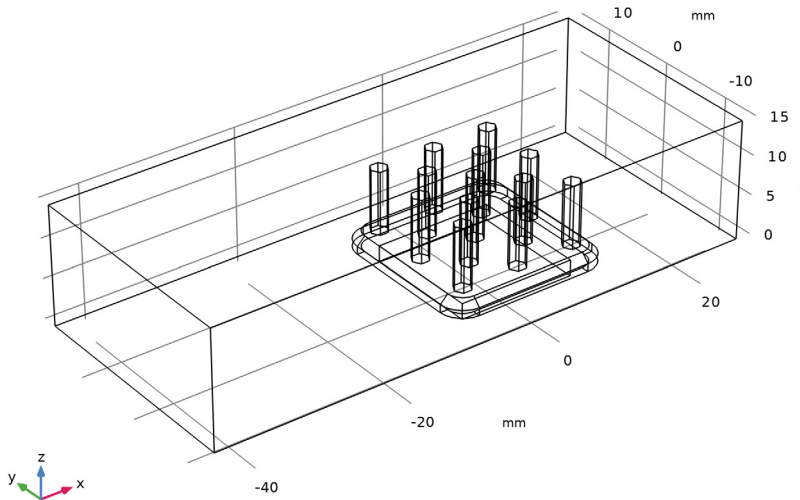

LAMINAR FLOW (SPF)

- 1 In the **Model Builder** window, under **Component 1 (comp1)** click **Laminar Flow (spf)**.
- 2 In the **Settings** window for **Laminar Flow**, locate the **Domain Selection** section.
- 3 From the **Selection** list, choose **Air**.

HEAT TRANSFER IN SOLIDS AND FLUIDS (HT)

Fluid 1

- 1 In the **Model Builder** window, under **Component 1 (comp1)** > **Heat Transfer in Solids and Fluids (ht)** click **Fluid 1**.
- 2 In the **Settings** window for **Fluid**, locate the **Domain Selection** section.
- 3 From the **Selection** list, choose **Air**.

MATERIALS

Next, add materials.

ADD MATERIAL

- 1 In the **Materials** toolbar, click  **Add Material** to open the **Add Material** window.

- 2 Go to the **Add Material** window.
- 3 In the tree, select **Built-in > Air**.
- 4 Click the **Add to Component** button in the window toolbar.
- 5 In the tree, select **Built-in > Aluminum 3003-H18**.
- 6 Click the **Add to Component** button in the window toolbar.
- 7 In the tree, select **Built-in > Silica glass**.
- 8 Click the **Add to Component** button in the window toolbar.
- 9 In the **Materials** toolbar, click  **Add Material** to close the **Add Material** window.

MATERIALS

Air (mat1)

- 1 In the **Settings** window for **Material**, locate the **Geometric Entity Selection** section.
- 2 From the **Selection** list, choose **Air**.

Aluminum 3003-H18 (mat2)

- 1 In the **Model Builder** window, click **Aluminum 3003-H18 (mat2)**.
- 2 In the **Settings** window for **Material**, locate the **Geometric Entity Selection** section.
- 3 From the **Selection** list, choose **Aluminum**.

Silica glass (mat3)

- 1 In the **Model Builder** window, click **Silica glass (mat3)**.
- 2 In the **Settings** window for **Material**, locate the **Geometric Entity Selection** section.
- 3 From the **Selection** list, choose **Silica Glass**.

GLOBAL DEFINITIONS

Parameters 1

- 1 In the **Model Builder** window, under **Global Definitions** click **Parameters 1**.
- 2 In the **Settings** window for **Parameters**, locate the **Parameters** section.
- 3 In the table, enter the following settings:

Name	Expression	Value	Description
U0	5[cm/s]	0.05 m/s	Mean inlet velocity
P0	1[W]	1 W	Total power dissipated by the electronics package

Now define the physical properties of the model. Start with the fluid domain.

Add a node for the ambient properties in the model. The default temperature value is 293.15 K. It is possible to edit the ambient temperature value or to define it using the meteorological data which gives access to climate data from more than 8600 stations in the world.

DEFINITIONS

Ambient Properties 1 (ampr1)

In the **Physics** toolbar, click  **Shared Properties** and choose **Ambient Properties**.



LAMINAR FLOW (SPF)

The no-slip condition is the default boundary condition for the fluid. Define the inlet and outlet conditions as described below.

Inlet 1

- 1 In the **Physics** toolbar, click  **Boundaries** and choose **Inlet**.
- 2 In the **Settings** window for **Inlet**, locate the **Boundary Selection** section.
- 3 From the **Selection** list, choose **Inlet**.
- 4 Locate the **Boundary Condition** section. From the list, choose **Fully developed flow**.
- 5 Locate the **Fully Developed Flow** section. In the U_{av} text field, type 0.

Outlet 1

- 1 In the **Physics** toolbar, click  **Boundaries** and choose **Outlet**.
- 2 Click the  **Zoom Extents** button in the **Graphics** toolbar.
- 3 In the **Settings** window for **Outlet**, locate the **Boundary Selection** section.
- 4 From the **Selection** list, choose **Outlet**.

HEAT TRANSFER IN SOLIDS AND FLUIDS (HT)

Thermal insulation is the default boundary condition for the temperature. Define the inlet temperature and the outlet condition as described below.

Inflow 1

- 1 In the **Physics** toolbar, click  **Boundaries** and choose **Inflow**.
- 2 In the **Settings** window for **Inflow**, locate the **Boundary Selection** section.
- 3 From the **Selection** list, choose **Inlet**.

The ambient temperature is defined in the **Ambient Properties** node under **Shared Properties**.

Locate the **Upstream Properties** section. From the T_{ustr} list, choose **Ambient temperature (amp1)**.

Outflow 1

- 1 In the **Physics** toolbar, click  **Boundaries** and choose **Outflow**.
- 2 In the **Settings** window for **Outflow**, locate the **Boundary Selection** section.
- 3 From the **Selection** list, choose **Outlet**.

Next, use the P_0 parameter to define the total heat source in the electronics package.



Heat Source 1

- 1 In the **Physics** toolbar, click  **Domains** and choose **Heat Source**.
- 2 In the **Settings** window for **Heat Source**, locate the **Domain Selection** section.
- 3 From the **Selection** list, choose **Silica Glass**.
- 4 Locate the **Heat Source** section. From the **Heat source** list, choose **Heat rate**.
- 5 In the P_0 text field, type P_0 .

MESH 1

- 1 In the **Model Builder** window, under **Component 1 (comp1)** click **Mesh 1**.
- 2 In the **Settings** window for **Mesh**, locate the **Physics-Controlled Mesh** section.
- 3 From the **Element size** list, choose **Coarser**.
- 4 Click  **Build All**.

To get a better view of the mesh, hide some of the boundaries.

- 5 Click the  **Click and Hide** button in the **Graphics** toolbar.
- 6 In the **Graphics** window toolbar, click  next to  **Select Domains**, then choose **Select Boundaries**.

7 Select Boundaries 1, 2, and 4 only.

The finished mesh should look like that in the figure below.

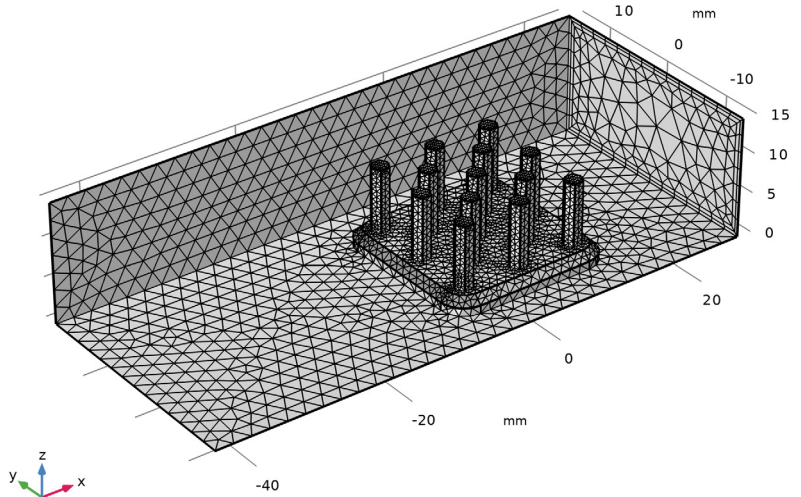

To achieve more accurate numerical results, this mesh can be refined by choosing another predefined element size. However, doing so requires more computational time and memory.

STUDY 1

In the **Study** toolbar, click  **Compute**.

RESULTS

Four default plots are generated automatically. The first one shows the temperature in the channel, the second one shows the velocity magnitude on three mutually perpendicular slices, and the third one shows the pressure field. The last plot visualizes the velocity field with wall temperature.

Transparency 1

- 1 In the **Model Builder** window, expand the **Results > Temperature (ht)** node.
- 2 Right-click **Volume 1** and choose **Transparency**.

Temperature and Fluid Flow (nitf1)

Apply the following steps to the fourth default plot.



Fluid Flow

- 1 In the **Model Builder** window, expand the **Temperature and Fluid Flow (nitf1)** node, then click **Fluid Flow**.
- 2 In the **Settings** window for **Arrow Volume**, locate the **Arrow Positioning** section.
- 3 Find the **x grid points** subsection. In the **Points** text field, type 40.
- 4 Find the **y grid points** subsection. In the **Points** text field, type 20.
- 5 Find the **z grid points** subsection. From the **Entry method** list, choose **Coordinates**.
- 6 In the **Coordinates** text field, type 5.

Filter 1

- 1 In the **Model Builder** window, expand the **Fluid Flow** node, then click **Filter 1**.
- 2 In the **Settings** window for **Filter**, locate the **Element Selection** section.
- 3 In the **Logical expression for inclusion** text field, type `spf.U>0.25*nitf1.Uave`.
- 4 In the **Temperature and Fluid Flow (nitf1)** toolbar, click  **Plot**.
Finally, check the energy balance.

RESULT TEMPLATES

- 1 In the **Results** toolbar, click  **Result Templates** to open the **Result Templates** window.
- 2 Go to the **Result Templates** window.
- 3 In the tree, select **Study 1/Solution 1 (sol1) > Heat Transfer in Solids and Fluids > Energy Balance (ht)**.
- 4 Click the **Add Result Template** button in the window toolbar.
- 5 In the **Results** toolbar, click  **Result Templates** to close the **Result Templates** window.

RESULTS

Energy Balance (ht)

- 1 In the **Energy Balance (ht)** toolbar, click  **Evaluate**.

In the **Energy Balance (ht)** table underneath the **Graphics** window you can verify that the energy-balance value is close to zero, indicating a good energy balance. Furthermore, as expected in a stationary model, the total accumulated energy rate is equal to zero. The total net energy rate is close to 1 W, which balances the total heat source. Finally, the total work source is close to zero, because there are no external forces performing work and the work done by viscous stresses is negligible.

Geometry Modeling Instructions

If you want to create the geometry yourself, follow these steps.

GLOBAL DEFINITIONS

Parameters 1

- 1 In the **Model Builder** window, under **Global Definitions** click **Parameters 1**.
- 2 In the **Settings** window for **Parameters**, locate the **Parameters** section.
- 3 In the table, enter the following settings:

Name	Expression	Value	Description
L_channel	7[cm]	0.07 m	Channel length
W_channel	3[cm]	0.03 m	Channel width
H_channel	1.5[cm]	0.015 m	Channel height
L_chip	1.5[cm]	0.015 m	Chip size
H_chip	2[mm]	0.002 m	Chip height

ADD COMPONENT

In the **Home** toolbar, click  **Add Component** and choose **3D**.

GEOMETRY 1

- 1 In the **Settings** window for **Geometry**, locate the **Units** section.
- 2 From the **Length unit** list, choose **mm**.

Work Plane 1 (wp1)

- 1 In the **Geometry** toolbar, click  **Work Plane**.
- 2 In the **Settings** window for **Work Plane**, locate the **Plane Definition** section.
- 3 From the **Plane** list, choose **xz-plane**.
- 4 In the **y-coordinate** text field, type -7.5.

Work Plane 1 (wp1) > Plane Geometry

In the **Model Builder** window, click **Plane Geometry**.

Work Plane 1 (wp1) > Polygon 1 (pol1)

- 1 In the **Work Plane** toolbar, click  **Polygon**.
- 2 In the **Settings** window for **Polygon**, locate the **Coordinates** section.
- 3 From the **Data source** list, choose **Vectors**.

- 4 In the **xw** text field, type -10.495 -9.495 -9.495 -9.495 -9.495 -10.495 -10.495 -10.495.
- 5 In the **yw** text field, type 0 0 0 2 2 1 1 0.

Revolve 1 (rev1)

- 1 In the **Model Builder** window, under **Component 1 (comp1) > Geometry 1** right-click **Work Plane 1 (wp1)** and choose **Revolve**.
- 2 In the **Settings** window for **Revolve**, locate the **Revolution Angles** section.
- 3 Click the **Angles** button.
- 4 In the **End angle** text field, type 90.
- 5 Locate the **Revolution Axis** section. From the **Axis type** list, choose **3D**.
- 6 Find the **Point on the revolution axis** subsection. In the **x** text field, type -7.5.
- 7 In the **y** text field, type -7.5.
- 8 Find the **Direction of revolution axis** subsection. In the **y** text field, type 0.
- 9 In the **z** text field, type 1.
- 10 Locate the **Selections of Resulting Entities** section. Find the **Cumulative selection** subsection. Click **New**.
- 11 In the **New Cumulative Selection** dialog, type Aluminum in the **Name** text field.
- 12 Click **OK**.

Extrude 1 (ext1)

- 1 In the **Geometry** toolbar, click  **Extrude**.
- 2 In the **Settings** window for **Extrude**, locate the **General** section.
- 3 From the **Extrude from** list, choose **Faces**.
- 4 On the object **rev1**, select Boundary 1 only.
- 5 Locate the **Distances** section. In the table, enter the following settings:

Distances (mm)
15

- 6 Locate the **Selections of Resulting Entities** section. Find the **Cumulative selection** subsection. From the **Contribute to** list, choose **Aluminum**.
- 7 Locate the **General** section. In the tree, select **rev1**.

Rotate 1 (rot1)

- 1 In the **Geometry** toolbar, click  **Transforms** and choose **Rotate**.

- 2 In the **Settings** window for **Rotate**, locate the **Input** section.
- 3 From the **Input objects** list, choose **Aluminum**.
- 4 Select the **Keep input objects** checkbox.
- 5 Locate the **Rotation** section. In the **Angle** text field, type range (90, 90, 270).
- 6 Locate the **Selections of Resulting Entities** section. Find the **Cumulative selection** subsection. From the **Contribute to** list, choose **Aluminum**.

Work Plane 2 (wp2)

- 1 In the **Geometry** toolbar, click  **Work Plane**.
- 2 In the **Settings** window for **Work Plane**, locate the **Plane Definition** section.
- 3 From the **Plane type** list, choose **Face parallel**.
- 4 On the object **ext1**, select Boundary 4 only.

Work Plane 2 (wp2) > Plane Geometry

In the **Model Builder** window, click **Plane Geometry**.



Work Plane 2 (wp2) > Cross Section 1 (cro1)

- 1 In the **Work Plane** toolbar, click  **Cross Section**.
- 2 In the **Settings** window for **Cross Section**, locate the **Selections of Resulting Entities** section.
- 3 Select the **Resulting objects selection** checkbox.

Work Plane 2 (wp2) > Convert to Curve 1 (ccur1)

- 1 In the **Work Plane** toolbar, click  **Conversions** and choose **Convert to Curve**.
- 2 In the **Settings** window for **Convert to Curve**, locate the **Input** section.
- 3 From the **Input objects** list, choose **Cross Section 1**.
- 4 Locate the **Selections of Resulting Entities** section. Select the **Resulting objects selection** checkbox.



Work Plane 2 (wp2) > Convert to Solid 1 (csol1)

- 1 In the **Work Plane** toolbar, click  **Conversions** and choose **Convert to Solid**.
- 2 In the **Settings** window for **Convert to Solid**, locate the **Input** section.
- 3 From the **Input objects** list, choose **Convert to Curve 1**.
- 4 Click  **Build Selected**.



Work Plane 2 (wp2) > Box Selection 1 (boxsel1)

In the **Work Plane** toolbar, click  **Selections** and choose **Box Selection**.

Work Plane 2 (wp2) > Box Selection 2 (boxsel2)

- 1 In the **Work Plane** toolbar, click  **Selections** and choose **Box Selection**.
- 2 In the **Settings** window for **Box Selection**, locate the **Box Limits** section.
- 3 In the **xw minimum** text field, type -10.
- 4 In the **xw maximum** text field, type -10.
- 5 In the **yw minimum** text field, type 0.
- 6 In the **yw maximum** text field, type 0.
- 7 In the **Work Plane** toolbar, click  **Build All**.

Work Plane 2 (wp2) > Difference Selection 1 (difsell1)

- 1 In the **Work Plane** toolbar, click  **Selections** and choose **Difference Selection**.
- 2 In the **Settings** window for **Difference Selection**, locate the **Input Entities** section.
- 3 Click the  **Add** button for **Selections to add**.
- 4 In the **Add** dialog, select **Box Selection 1** in the **Selections to add** list.
- 5 Click **OK**.
- 6 In the **Settings** window for **Difference Selection**, locate the **Input Entities** section.
- 7 Click the  **Add** button for **Selections to subtract**.
- 8 In the **Add** dialog, select **Box Selection 2** in the **Selections to subtract** list.
- 9 Click **OK**.

Work Plane 2 (wp2) > Delete Entities 1 (dell1)

- 1 Right-click **Plane Geometry** and choose **Delete Entities**.
- 2 In the **Settings** window for **Delete Entities**, locate the **Entities or Objects to Delete** section.
- 3 From the **Geometric entity level** list, choose **Domain**.
- 4 From the **Selection** list, choose **Difference Selection 1**.

Extrude 2 (ext2)

- 1 In the **Model Builder** window, under **Component 1 (comp1) > Geometry 1** right-click **Work Plane 2 (wp2)** and choose **Extrude**.
- 2 In the **Settings** window for **Extrude**, locate the **Distances** section.
- 3 In the table, enter the following settings:

Distances (mm)
2

- 4 Select the **Reverse direction** checkbox.
- 5 Locate the **Selections of Resulting Entities** section. Find the **Cumulative selection** subsection. From the **Contribute to** list, choose **Aluminum**.

Work Plane 3 (wp3)

- 1 In the **Geometry** toolbar, click  **Work Plane**.
- 2 In the **Settings** window for **Work Plane**, locate the **Plane Definition** section.
- 3 In the **z-coordinate** text field, type 2.
- 4 Locate the **Unite Objects** section. Clear the **Unite objects** checkbox.

Work Plane 3 (wp3) > Plane Geometry

In the **Model Builder** window, click **Plane Geometry**.

Work Plane 3 (wp3) > Polygon 1 (pol1)

- 1 In the **Work Plane** toolbar, click  **Polygon**.
- 2 In the **Settings** window for **Polygon**, locate the **Coordinates** section.
- 3 From the **Data source** list, choose **Vectors**.
- 4 In the **xw** text field, type -8.597 -8.048 -8.048 -6.952 -6.952 -6.4 -6.4 -6.952 -6.952 -8.048.
- 5 In the **yw** text field, type -7.5 -8.45 -8.45 -8.45 -8.45 -7.5 -7.5 -6.55 -6.55 -6.55.

Work Plane 3 (wp3) > Copy 1 (copy1)



- 1 In the **Work Plane** toolbar, click  **Transforms** and choose **Copy**.
- 2 Select the object **pol1** only.
- 3 In the **Settings** window for **Copy**, locate the **Displacement** section.
- 4 In the **xw** text field, type 3.748.
- 5 In the **yw** text field, type 3.748.

Extrude 3 (ext3)

- 1 In the **Model Builder** window, under **Component 1 (comp1) > Geometry 1** right-click **Work Plane 3 (wp3)** and choose **Extrude**.
- 2 In the **Settings** window for **Extrude**, locate the **Distances** section.
- 3 In the table, enter the following settings:

Distances (mm)
8

Array 1 (arr1)

- 1 In the **Geometry** toolbar, click  **Transforms** and choose **Array**.
- 2 Click the  **Zoom Extents** button in the **Graphics** toolbar.
- 3 Select the object **ext3(1)** only.
- 4 In the **Settings** window for **Array**, locate the **Size** section.
- 5 In the **x size** text field, type 3.
- 6 In the **y size** text field, type 3.
- 7 Locate the **Displacement** section. In the **x** text field, type 7.495.
- 8 In the **y** text field, type 7.495.
- 9 Locate the **Selections of Resulting Entities** section. Find the **Cumulative selection** subsection. From the **Contribute to** list, choose **Aluminum**.

Array 2 (arr2)

- 1 In the **Geometry** toolbar, click  **Transforms** and choose **Array**.
- 2 Select the object **ext3(2)** only.
- 3 In the **Settings** window for **Array**, locate the **Size** section.
- 4 In the **x size** text field, type 2.
- 5 In the **y size** text field, type 2.
- 6 Locate the **Displacement** section. In the **x** text field, type 7.495.
- 7 In the **y** text field, type 7.495.
- 8 Locate the **Selections of Resulting Entities** section. Find the **Cumulative selection** subsection. From the **Contribute to** list, choose **Aluminum**.

Union 1 (un1)

- 1 In the **Geometry** toolbar, click  **Booleans and Partitions** and choose **Union**.
- 2 In the **Settings** window for **Union**, locate the **Union** section.
- 3 From the **Input objects** list, choose **Aluminum**.
- 4 Locate the **Selections of Resulting Entities** section. Find the **Cumulative selection** subsection. From the **Contribute to** list, choose **Aluminum**.
- 5 Locate the **Union** section. Clear the **Keep interior boundaries** checkbox.

Block 1 (blk1)

- 1 In the **Geometry** toolbar, click  **Block**.
- 2 In the **Settings** window for **Block**, locate the **Size and Shape** section.
- 3 In the **Width** text field, type L_chip.

- 4 In the **Depth** text field, type L_{chip} .
- 5 In the **Height** text field, type H_{chip} .
- 6 Locate the **Position** section. From the **Base** list, choose **Center**.
- 7 In the **z** text field, type $-H_{chip}/2$.
- 8 Locate the **Selections of Resulting Entities** section. Find the **Cumulative selection** subsection. Click **New**.
- 9 In the **New Cumulative Selection** dialog, type Silica Glass in the **Name** text field.
- 10 Click **OK**.



Block 2 (blk2)

- 1 In the **Geometry** toolbar, click  **Block**.
- 2 In the **Settings** window for **Block**, locate the **Size and Shape** section.
- 3 In the **Width** text field, type $L_{channel}$.
- 4 In the **Depth** text field, type $W_{channel}$.
- 5 In the **Height** text field, type $H_{channel}$.
- 6 Locate the **Position** section. In the **x** text field, type -45 .
- 7 In the **y** text field, type $-W_{channel}/2$.

Form Union (fin)

- 1 In the **Model Builder** window, click **Form Union (fin)**.
- 2 In the **Settings** window for **Form Union/Assembly**, click  **Build Selected**.

Air

- 1 In the **Geometry** toolbar, click  **Selections** and choose **Explicit Selection**.
- 2 On the object **fin**, select Domain 1 only.
- 3 In the **Settings** window for **Explicit Selection**, type Air in the **Label** text field.
- 4 Click the  **Zoom Extents** button in the **Graphics** toolbar.

Inlet

- 1 In the **Geometry** toolbar, click  **Selections** and choose **Explicit Selection**.
- 2 In the **Settings** window for **Explicit Selection**, type Inlet in the **Label** text field.
- 3 Locate the **Entities to Select** section. From the **Geometric entity level** list, choose **Boundary**.
- 4 On the object **fin**, select Boundary 129 only.

Outlet

- 1 In the **Geometry** toolbar, click  **Selections** and choose **Explicit Selection**.
- 2 In the **Settings** window for **Explicit Selection**, type Outlet in the **Label** text field.
- 3 Locate the **Entities to Select** section. From the **Geometric entity level** list, choose **Boundary**.
- 4 On the object **fin**, select Boundary 1 only.

Air Boundaries

- 1 In the **Geometry** toolbar, click  **Selections** and choose **Adjacent Selection**.
- 2 In the **Settings** window for **Adjacent Selection**, locate the **Input Entities** section.
- 3 Click **+ Add**.
- 4 In the **Add** dialog, select **Air** in the **Input selections** list.
- 5 Click **OK**.
- 6 In the **Settings** window for **Adjacent Selection**, type Air Boundaries in the **Label** text field.

Exterior Walls

- 1 In the **Geometry** toolbar, click  **Selections** and choose **Difference Selection**.
- 2 In the **Settings** window for **Difference Selection**, type Exterior Walls in the **Label** text field.
- 3 Locate the **Geometric Entity Level** section. From the **Level** list, choose **Boundary**.
- 4 Locate the **Input Entities** section. Click the **+ Add** button for **Selections to add**.
- 5 In the **Add** dialog, select **Air Boundaries** in the **Selections to add** list.
- 6 Click **OK**.
- 7 In the **Settings** window for **Difference Selection**, locate the **Input Entities** section.
- 8 Click the **+ Add** button for **Selections to subtract**.
- 9 In the **Add** dialog, in the **Selections to subtract** list, choose **Inlet** and **Outlet**.
- 10 Click **OK**.

Thermal Grease

- 1 In the **Geometry** toolbar, click  **Selections** and choose **Intersection Selection**.
- 2 In the **Settings** window for **Intersection Selection**, type Thermal Grease in the **Label** text field.
- 3 Locate the **Geometric Entity Level** section. From the **Level** list, choose **Boundary**.
- 4 Locate the **Input Entities** section. Click **+ Add**.

- 5 In the **Add** dialog, in the **Selections to intersect** list, choose **Aluminum** and **Silica Glass**.
- 6 Click **OK**.