



Model created in COMSOL Multiphysics 6.4

Isothermal MEMS Heat Exchanger

Introduction

The following example builds and solves a conduction and convection heat transfer problem using the Heat Transfer interface.

The example concerns a stainless-steel MEMS heat exchanger, which you can find in lab-on-a-chip devices in biotechnology and in microreactors such as for micro fuel cells. This application examines the heat exchanger in 3D, and it involves heat transfer through both convection and conduction.

Model Definition

Figure 1 shows the geometry of the heat exchanger. It is necessary to model only one unit cell because they are all almost identical except for edge effects in the outer cells.

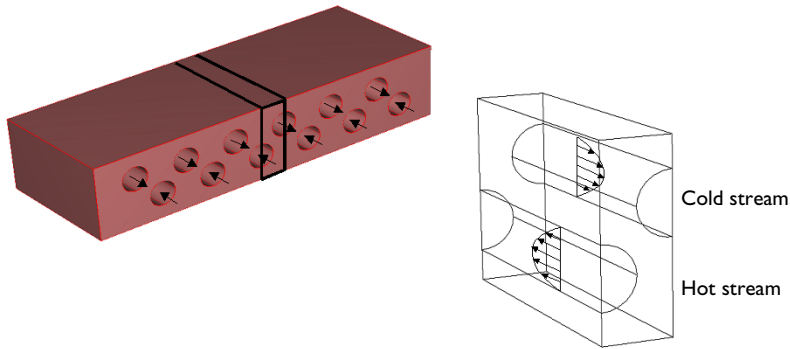

Figure 1: Depiction of the modeled part of the heat exchanger (left).

The governing equation for this model is the heat equation for conductive and convective heat transfer

$$\rho C_p \mathbf{u} \cdot \nabla T + \nabla \cdot (-k \nabla T) = Q$$

where C_p denotes the specific heat capacity (SI unit: J/(kg·K)), T is the temperature (SI unit: K), k is the thermal conductivity (SI unit: W/(m·K)), ρ is the density (SI unit: kg/m³), \mathbf{u} is the velocity vector (SI unit: m/s), and Q is a sink or source term (which you set to zero because there is no production or consumption of heat in the device).

In the solid part of the heat exchanger the velocity vector, $\mathbf{u} = (u, v, w)$, is set to zero in all directions. In the channels the velocity field is defined by an analytical expression that

approximates fully-developed laminar flow for a circular cross section. For both the hot and cold streams, you set the velocity components in the x and z directions to zero.

For the hot stream, the expression

$$v = v_{\max} \left(1 - \left(\frac{r}{R} \right)^2 \right)$$

gives the y -component of the velocity where

- v_{\max} is the maximum velocity (SI unit: m/s), which arises in the middle of the channel
- r is the distance from the center of the channel (SI unit: m)
- R is the channel radius (SI unit: m)

You describe velocity in the cold stream in the same manner but in the opposite direction

$$v = -v_{\max} \left(1 - \left(\frac{r}{R} \right)^2 \right)$$

In an extended approach, instead of using the analytical expression for the velocity field, the fluid in the channels can be simulated using the Laminar Flow interface. Here the density is defined as

$$\rho = \rho_m \left(1 - \frac{T - T_m}{T_m} \right)$$

where ρ_m is the mean density (SI unit: kg/m³), and $T_m = (T_{\text{cold}} + T_{\text{hot}})/2$ is the mean fluid temperature.

The boundary conditions are insulating for all outer surfaces except for the inlet and outlet boundaries in the fluid channels. At the inlets, you specify constant temperatures for the cold and hot streams, T_{cold} and T_{hot} , respectively. At the outlets, convection dominates the transport of heat so you apply the convective flux boundary condition:

$$-k \nabla T \cdot \mathbf{n} = 0$$

Results and Discussion

Figure 2 shows the temperature isosurfaces and the heat flux streamlines for the conductive heat flux in the device. The temperature isosurfaces clearly show the convective term's influence in the channels. Figure 3 displays the corresponding results for the extended application (see [Nonisothermal MEMS Heat Exchanger](#) for model description and results). As the plot shows, the temperature distribution is very similar to that in the

first study, which can therefore be concluded to be a good approximation of the extended case.

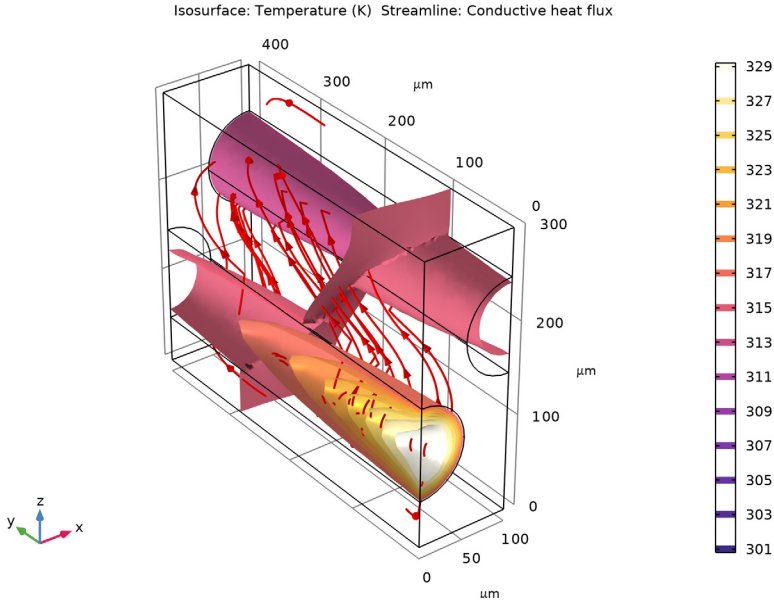

Figure 2: Isotherms and conductive heat flux streamlines in the cell unit's geometry.

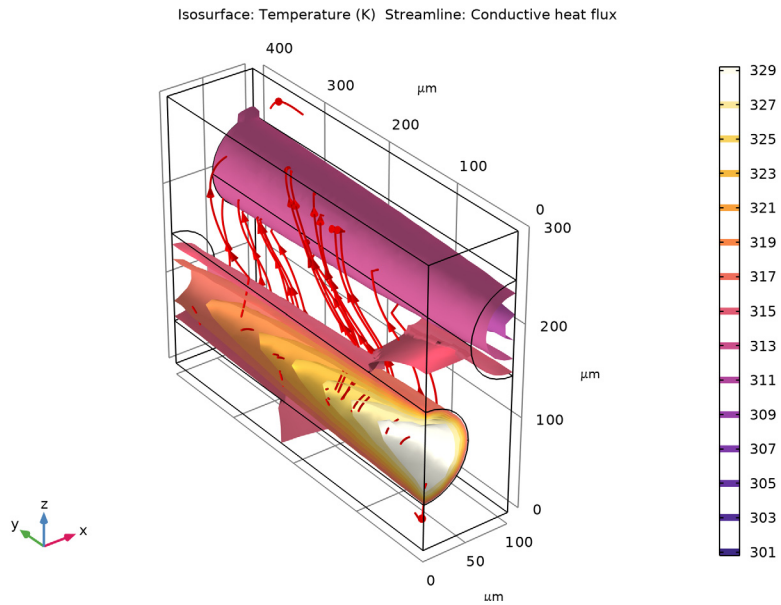



Figure 3: Extended application results; isotherms and conductive heat flux streamlines in the cell unit's geometry.

Application Library path: Heat_Transfer_Module/Heat_Exchangers/
heat_exchanger_iso

Modeling Instructions

From the **File** menu, choose **New**.

NEW



In the **New** window, click  **Model Wizard**.

MODEL WIZARD

1 In the **Model Wizard** window, click  **3D**.

2 In the **Select Physics** tree, select **Heat Transfer > Heat Transfer in Solids and Fluids (ht)**.

3 Click **Add**.

- 4 Click  **Study**.
- 5 In the **Select Study** tree, select **General Studies > Stationary**.
- 6 Click  **Done**.

GLOBAL DEFINITIONS

Parameters 1



- 1 In the **Model Builder** window, under **Global Definitions** click **Parameters 1**.
- 2 In the **Settings** window for **Parameters**, locate the **Parameters** section.
- 3 In the table, enter the following settings:

Name	Expression	Value	Description
R	50[um]	5E-5 m	Channel radius
v_max	50[mm/s]	0.05 m/s	Maximum velocity
T_hot	330[K]	330 K	Temperature, hot channel
T_cold	300[K]	300 K	Temperature, cold channel

GEOMETRY 1

- 1 In the **Model Builder** window, under **Component 1 (comp1)** click **Geometry 1**.
- 2 In the **Settings** window for **Geometry**, locate the **Units** section.
- 3 From the **Length unit** list, choose **µm**.

Block 1 (blk1)

- 1 In the **Geometry** toolbar, click  **Block**.
- 2 In the **Settings** window for **Block**, locate the **Size and Shape** section.
- 3 In the **Width** text field, type 100.
- 4 In the **Depth** text field, type 400.
- 5 In the **Height** text field, type 300.
- 6 In the **Geometry** toolbar, click  **Build All**.

Cylinder 1 (cyl1)

- 1 In the **Geometry** toolbar, click  **Cylinder**.
- 2 In the **Settings** window for **Cylinder**, locate the **Size and Shape** section.
- 3 In the **Radius** text field, type R.
- 4 In the **Height** text field, type 400.
- 5 Locate the **Position** section. In the **z** text field, type 2*R.

6 Locate the **Axis** section. From the **Axis type** list, choose **y-axis**.

7 In the **Geometry** toolbar, click  **Build All**.

Copy 1 (copy1)

1 In the **Geometry** toolbar, click  **Transforms** and choose **Copy**.

2 Select the object **cy11** only.

3 In the **Settings** window for **Copy**, locate the **Displacement** section.

4 In the **x** text field, type $2 * R$.

5 In the **z** text field, type $2 * R$.

6 In the **Geometry** toolbar, click  **Build All**.

Compose 1 (col)

1 In the **Geometry** toolbar, click  **Booleans and Partitions** and choose **Compose**.

2 Click in the **Graphics** window and then press Ctrl+A to select all objects.

3 In the **Settings** window for **Compose**, locate the **Compose** section.

4 In the **Set formula** text field, type $blk1 * (cy11 + copy1) + blk1$.

5 In the **Geometry** toolbar, click  **Build All**.

6 In the **Model Builder** window, click **Geometry 1**.

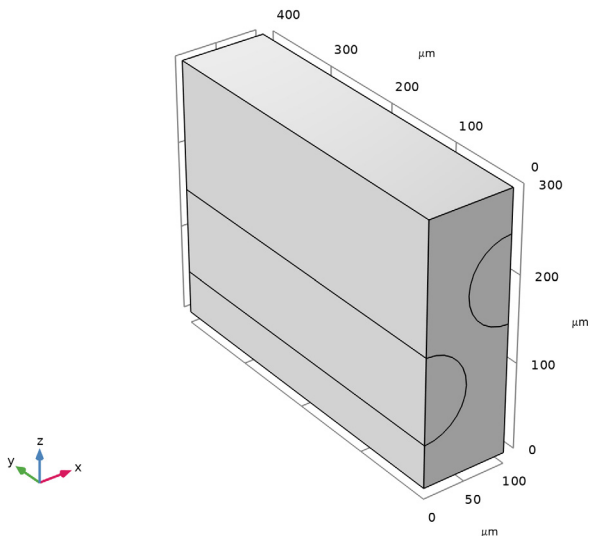

Define some selections that will be useful during the model setup.

DEFINITIONS

Solid

- 1 In the **Definitions** toolbar, click  **Explicit**.
- 2 In the **Settings** window for **Explicit**, type Solid in the **Label** text field.
- 3 Select Domain 1 only.

Hot Channel

- 1 In the **Definitions** toolbar, click  **Explicit**.
- 2 In the **Settings** window for **Explicit**, type Hot Channel in the **Label** text field.
- 3 Select Domain 2 only.

Cold Channel

- 1 In the **Definitions** toolbar, click  **Explicit**.
- 2 In the **Settings** window for **Explicit**, type Cold Channel in the **Label** text field.
- 3 Select Domain 3 only.

Channels

- 1 In the **Definitions** toolbar, click  **Union**.
- 2 In the **Settings** window for **Union**, type Channels in the **Label** text field.
- 3 Locate the **Input Entities** section. Under **Selections to add**, click **+ Add**.
- 4 In the **Add** dialog, in the **Selections to add** list, choose **Hot Channel** and **Cold Channel**.
- 5 Click **OK**.

Channel Walls

- 1 In the **Definitions** toolbar, click  **Adjacent**.
- 2 In the **Settings** window for **Adjacent**, type Channel Walls in the **Label** text field.
- 3 Locate the **Input Entities** section. Under **Input selections**, click **+ Add**.
- 4 In the **Add** dialog, in the **Input selections** list, choose **Solid** and **Channels**.
- 5 Click **OK**.
- 6 In the **Settings** window for **Adjacent**, locate the **Output Entities** section.
- 7 From the **Exterior boundaries** list, choose **None**.
- 8 Select the **Interior boundaries** checkbox.

Define two local variables for the radial component of a cylindrical coordinate system aligned with each channel. Later use them to define the laminar velocity profile.

Variables 1

- 1 In the **Definitions** toolbar, click  **Local Variables**.
- 2 In the **Settings** window for **Variables**, locate the **Geometric Entity Selection** section.
- 3 From the **Geometric entity level** list, choose **Domain**.
- 4 From the **Selection** list, choose **Hot Channel**.
- 5 Locate the **Variables** section. In the table, enter the following settings:



Name	Expression	Unit	Description
r	$\sqrt{x^2+(z-1e-4[m])^2}$	m	Radius, hot channel

Variables 2

- 1 In the **Definitions** toolbar, click  **Local Variables**.
- 2 In the **Settings** window for **Variables**, locate the **Geometric Entity Selection** section.
- 3 From the **Geometric entity level** list, choose **Domain**.
- 4 Select Domain 3 only.
- 5 From the **Selection** list, choose **Cold Channel**.
- 6 Locate the **Variables** section. In the table, enter the following settings:

Name	Expression	Unit	Description
r	$\sqrt{(x-1e-4[m])^2+(z-2e-4[m])^2}$	m	Radius, cold channel

ADD MATERIAL

- 1 In the **Materials** toolbar, click  **Add Material** to open the **Add Material** window.
- 2 Go to the **Add Material** window.
- 3 In the tree, select **Built-in > Steel AISI 4340**.
- 4 Click the **Add to Component** button in the window toolbar.
- 5 In the tree, select **Built-in > Water, liquid**.
- 6 Click the **Add to Component** button in the window toolbar.
- 7 In the **Materials** toolbar, click  **Add Material** to close the **Add Material** window.

MATERIALS

Steel AISI 4340 (mat1)

- 1 In the **Settings** window for **Material**, locate the **Geometric Entity Selection** section.
- 2 From the **Selection** list, choose **Solid**.

Water, liquid (mat2)

- 1 In the **Model Builder** window, click **Water, liquid (mat2)**.
- 2 In the **Settings** window for **Material**, locate the **Geometric Entity Selection** section.
- 3 From the **Selection** list, choose **Channels**.

HEAT TRANSFER IN SOLIDS AND FLUIDS (HT)

Fluid 1

- 1 In the **Model Builder** window, under **Component 1 (comp1)** > **Heat Transfer in Solids and Fluids (ht)** click **Fluid 1**.
- 2 In the **Settings** window for **Fluid**, locate the **Domain Selection** section.
- 3 From the **Selection** list, choose **Hot Channel**.
- 4 Locate the **Heat Convection** section. Specify the **u** vector as

0	x
$v_max * (1 - (r/R)^2)$	y
0	z

- 5 Locate the **Thermodynamics, Fluid** section. From the **Fluid type** list, choose **Gas/Liquid**.
- 6 From the γ list, choose **User defined**.

Fluid 2

- 1 In the **Physics** toolbar, click  **Domains** and choose **Fluid**.
- 2 In the **Settings** window for **Fluid**, locate the **Domain Selection** section.
- 3 From the **Selection** list, choose **Cold Channel**.
- 4 Locate the **Heat Convection** section. Specify the **u** vector as

0	x
$-v_max * (1 - (r/R)^2)$	y
0	z

- 5 Locate the **Thermodynamics, Fluid** section. From the **Fluid type** list, choose **Gas/Liquid**.
- 6 From the γ list, choose **User defined**.

Inflow 1

- 1 In the **Physics** toolbar, click  **Boundaries** and choose **Inflow**.
- 2 Select Boundary 5 only.
- 3 In the **Settings** window for **Inflow**, locate the **Upstream Properties** section.

4 In the T_{ustr} text field, type T_hot.

Inflow 2

- 1 In the **Physics** toolbar, click  **Boundaries** and choose **Inflow**.
- 2 Select Boundary 15 only.
- 3 In the **Settings** window for **Inflow**, locate the **Upstream Properties** section.
- 4 In the T_{ustr} text field, type T_cold.

Outflow 1

- 1 In the **Physics** toolbar, click  **Boundaries** and choose **Outflow**.
- 2 Select Boundaries 11 and 14 only.

MESH 1

Free Triangular 1

- 1 In the **Mesh** toolbar, click  **More Generators** and choose **Free Triangular**.
- 2 In the **Settings** window for **Free Triangular**, locate the **Boundary Selection** section.
- 3 From the **Selection** list, choose **Channel Walls**.

Size 1

- 1 Right-click **Free Triangular 1** and choose **Size**.
- 2 In the **Settings** window for **Size**, locate the **Element Size** section.
- 3 Click the **Custom** button.
- 4 Locate the **Element Size Parameters** section.
- 5 Select the **Maximum element size** checkbox. In the associated text field, type 10[um].

Free Tetrahedral 1

- 1 In the **Mesh** toolbar, click  **Free Tetrahedral**.
- 2 In the **Model Builder** window, right-click **Mesh 1** and choose **Build All**.

STUDY 1

In the **Study** toolbar, click  **Compute**.



RESULTS

Temperature (ht)

The default plot shows the temperature.

Add the isothermal contours plot from the **Result Templates** to reproduce the [Figure 2](#).

RESULT TEMPLATES

- 1 In the **Results** toolbar, click  **Result Templates** to open the **Result Templates** window.
- 2 Go to the **Result Templates** window.
- 3 In the tree, select **Study 1/Solution 1 (sol1) > Heat Transfer in Solids and Fluids > Isothermal Contours (ht)**.
- 4 Click the **Add Result Template** button in the window toolbar.
- 5 In the **Results** toolbar, click  **Result Templates** to close the **Result Templates** window.

RESULTS

Temperature Isosurfaces and Conductive Heat Flux Streamlines

In the **Settings** window for **3D Plot Group**, type **Temperature Isosurfaces and Conductive Heat Flux Streamlines** in the **Label** text field.

Isosurface 1



- 1 In the **Model Builder** window, expand the **Temperature Isosurfaces and Conductive Heat Flux Streamlines** node, then click **Isosurface 1**.
- 2 In the **Settings** window for **Isosurface**, locate the **Levels** section.
- 3 From the **Entry method** list, choose **Levels**.
- 4 In the **Levels** text field, type range (301, 2, 329).

Temperature Isosurfaces and Conductive Heat Flux Streamlines

In the **Model Builder** window, click

Temperature Isosurfaces and Conductive Heat Flux Streamlines.

Streamline 1

- 1 In the **Temperature Isosurfaces and Conductive Heat Flux Streamlines** toolbar, click  **Streamline**.
- 2 In the **Settings** window for **Streamline**, locate the **Streamline Positioning** section.
- 3 From the **Positioning** list, choose **Starting-point controlled**.
- 4 Locate the **Coloring and Style** section. Find the **Line style** subsection. From the **Type** list, choose **Tube**.
- 5 Select the **Radius scale factor** checkbox.
- 6 Find the **Point style** subsection. From the **Type** list, choose **Arrow**.
- 7 In the **Temperature Isosurfaces and Conductive Heat Flux Streamlines** toolbar, click  **Plot**.

